

Remove both A-pillar trim panels (see TOPIx Workshop Manual, section 501-05).

3.  **NOTE: This procedure must be carried out on both sides.**

Remove both B-pillar trim panels (see TOPIx Workshop Manual, section 501-05).

4.  **NOTE: This procedure must be carried out on both sides.**

Remove both C-pillar trim panels (see TOPIx Workshop Manual, section 501-05).

5.  **NOTE: This procedure must be carried out on both sides.**

Remove both D-pillar trim panels (see TOPIx Workshop Manual, section 501-05).

6.  **NOTE: This procedure must be carried out on both sides.**

Remove the overhead console (see TOPIx Workshop Manual, section 501-12).

7.  **NOTE: Note the orientation of the seal prior to detaching.**

Reposition the tailgate seal.



E158940

8.  **NOTE: This procedure must be carried out on both sides.**

Remove the roof handle and position the front door seal to one side.

- Torque: 6 Nm.

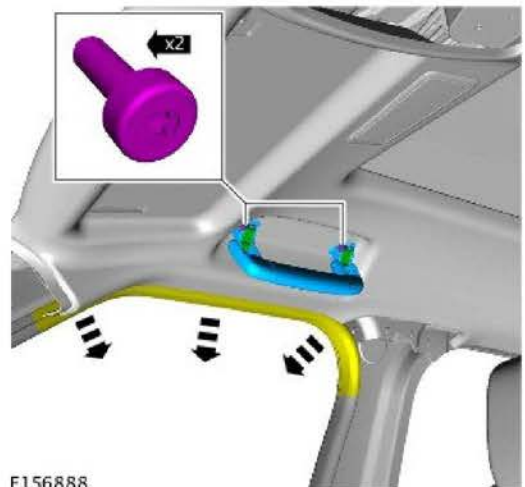

E156888

9.  **NOTE: This procedure must be carried out on both sides.**

Remove the roof handle and position the rear door seal to one side.

- Torque: 6 Nm.

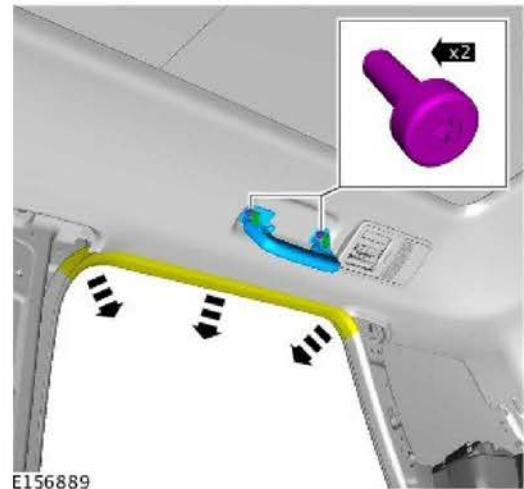

10.  **NOTE: This procedure must be carried out on both sides.**

Remove the interior lamp cover.

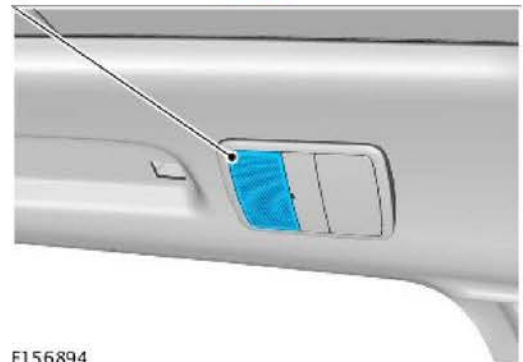

11.  **NOTE: This procedure must be carried out on both sides.**

Remove the interior lamp cover retaining bolt.

- Torque: 6 Nm.

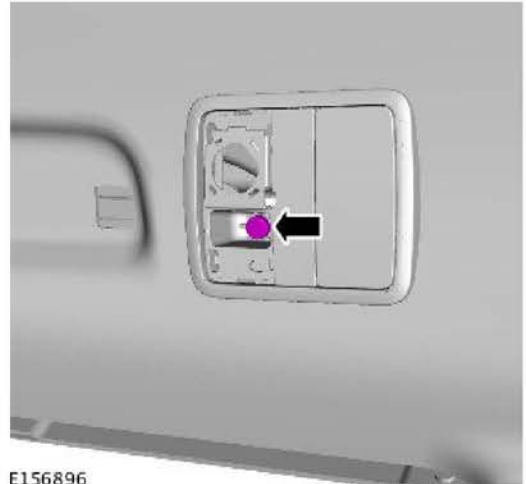

E156896

12.  **NOTE: This procedure must be carried out on both sides if equipped.**

Remove the roof air vents.

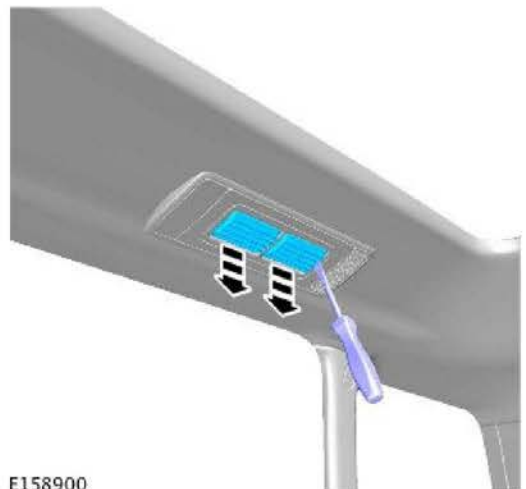

E158900

13.  **NOTE: This procedure must be carried out on both sides if equipped.**

Remove the roof air vent fixings.

- Torque: 6 Nm.



E148610

14.  **CAUTION:**
Take extra care not to damage the component.

 **NOTE:**
This procedure must be carried out on both sides if equipped.

Detach the headliner retainers as shown.

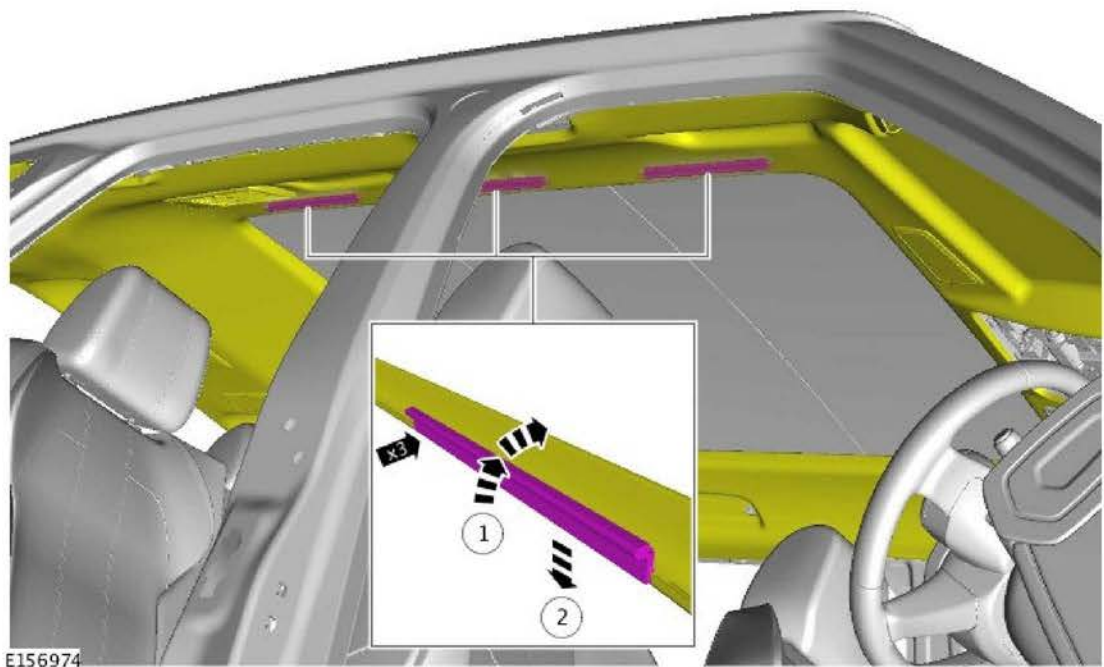

15.  **CAUTION:** Take extra care not to damage the component.

 **CAUTION:** Using a suitable plastic trim tool, release the magnetic fixings.

 **CAUTION:** Make sure that there is at least 50mm clearance between the magnetic fixings and the headliner during the removal procedure. The fixings will engage if too close to each other.

Remove the headliner retaining clips as shown.

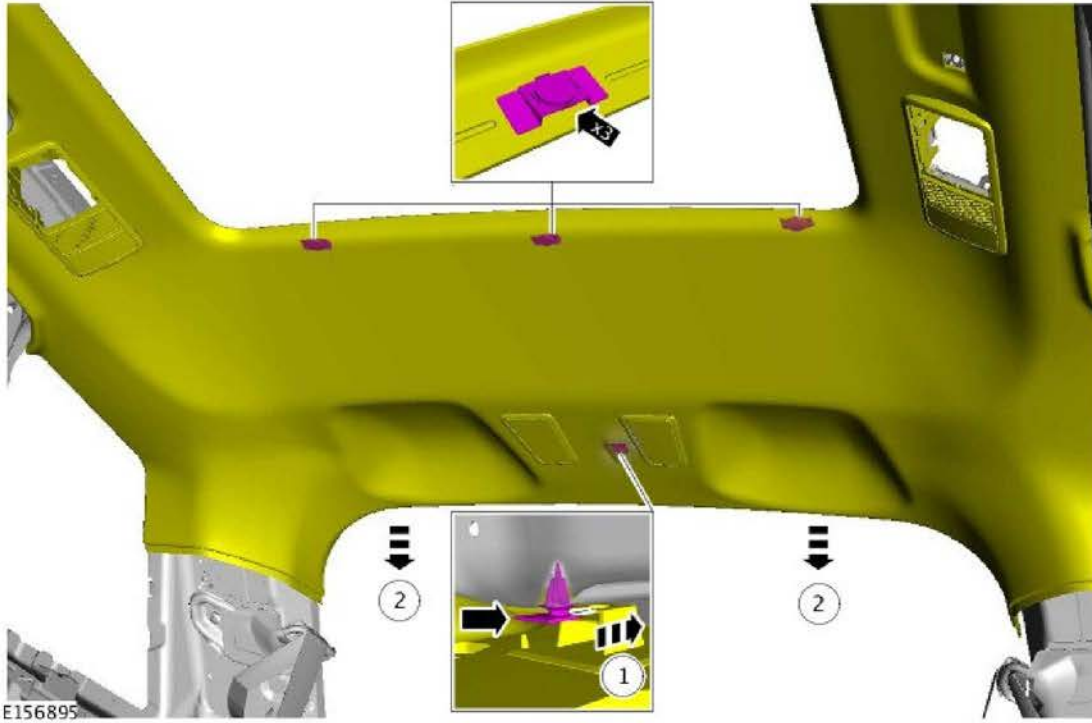

16. Remove the headliner retaining clips as shown.

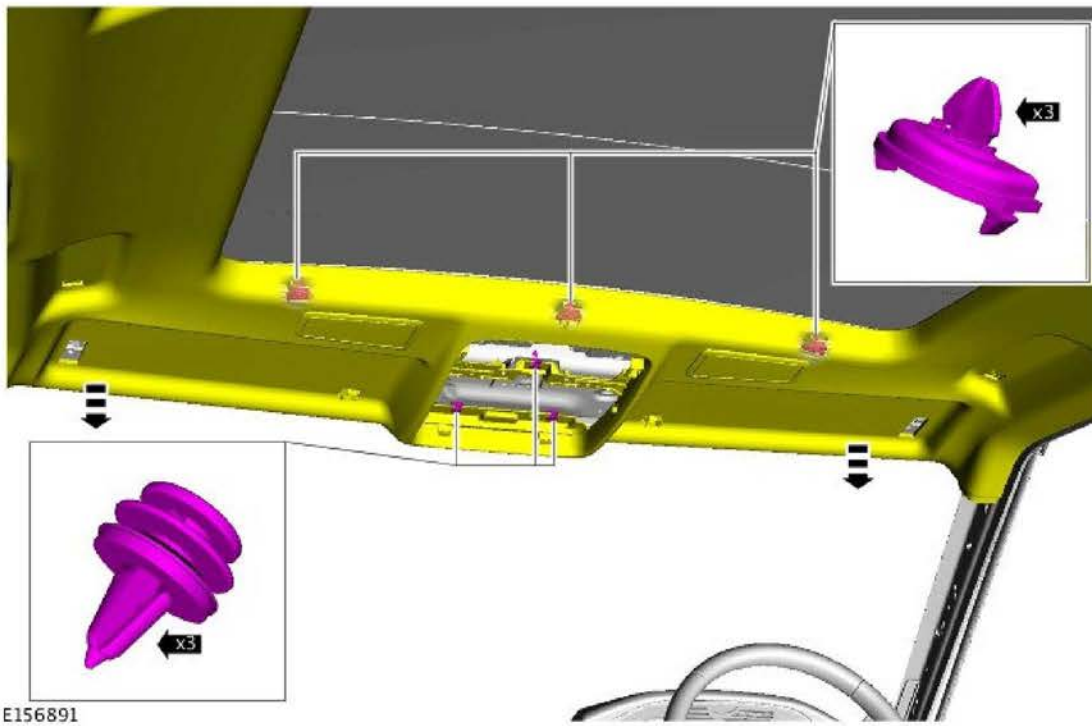

17.  **CAUTION:** Take extra care not to damage the component.

Lower the headliner.

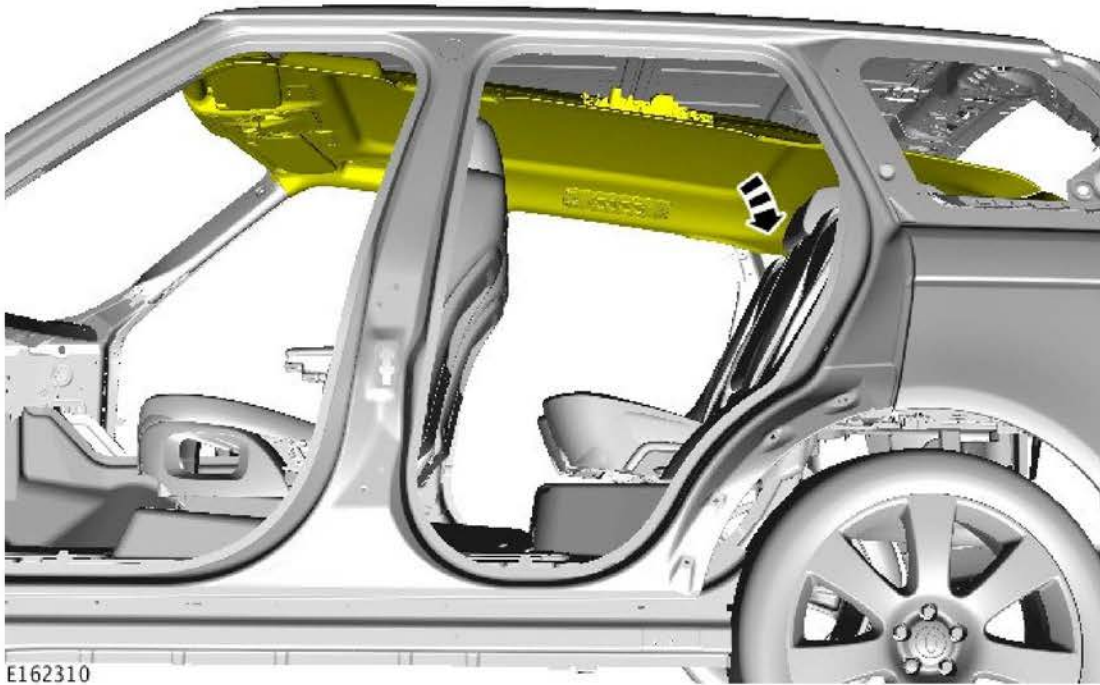

E162310

18. Remove the roof pod retaining nuts.



E165562

19. Disconnect the roof pod electrical connectors.

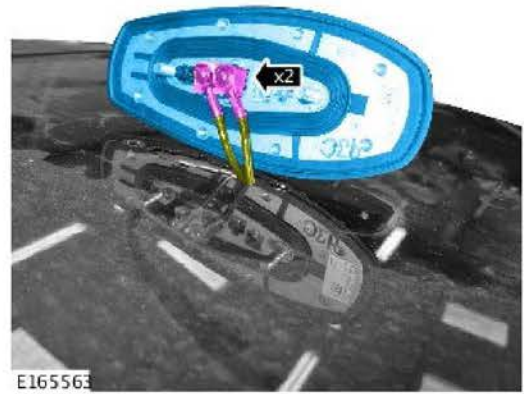

20. Remove and discard the roof pod.

21. Reverse steps 1-20 to install the new roof pod.