

- ATTENTION:**
- GENERAL MANAGER
 - PARTS MANAGER
 - CLAIMS PERSONNEL
 - SERVICE MANAGER

IMPORTANT - All Service Personnel Should Read and Initial in the boxes provided, right.

© 2014 Subaru of America, Inc. All rights reserved.



QUALITY DRIVEN® SERVICE

SERVICE BULLETIN

APPLICABILITY: 2015MY Legacy and Outback Models **NUMBER:** 12-176-14
SUBJECT: Service Procedure to Address a Wind Rushing Sound **DATE:** 12/05/14
 from the Front Door Sash Area

INTRODUCTION

This bulletin provides a service procedure to address customer concerns of a wind rushing-type sound which seems to come from the front door glass sash area. Customers may report a concern with one or both front doors. It is only necessary to address the side with the confirmed condition. The door glass sash separates the main door glass from the small partition glass on each door. The procedure involves replacement of the front door glass run channel (weatherstrip), partition glass/weatherstrip, sash and both the inner and outer door glass weatherstrips (sweeps). In addition, two pre-cut pieces of self-adhesive EPT foam, 1 piece of non-woven tape (will be cut into 3 pieces) and 1 piece of butyl (adhesive rubber) sealing material will be added in specific locations.

COUNTERMEASURE IN PRODUCTION

Countermeasures were incorporated into production on October 10, 2014 starting with the following VINs: **F3028031** (LEGACY) and **F3243546** (OUTBACK).

PART INFORMATION

The chart below provides a required part list for the Service Procedure described in this bulletin. This list is provided as a reference only and may not be totally complete depending on the needs of your specific repair. Always verify with your Parts Department that all needed parts with the most up-to-date part numbers are ordered.

PART NAME	PART NUMBER
REPAIR KIT LEG/OBK F RH	61099AL00A
REPAIR KIT LEG/OBK F LH	61099AL01A

The parts kit will consist of the following components: (p.n. 61099AL00A (Right Front Kit is shown)

ID	DESCRIPTION	QUANTITY
A	Weatherstrip Inner	1
B	Glass Assy.	1
C	Sash	1
D	Glass Run Channel	1

Continued...

CAUTION: VEHICLE SERVICING PERFORMED BY UNTRAINED PERSONS COULD RESULT IN SERIOUS INJURY TO THOSE PERSONS OR TO OTHERS.

Subaru Service Bulletins are intended for use by professional technicians ONLY. They are written to inform those technicians of conditions that may occur in some vehicles, or to provide information that could assist in the proper servicing of the vehicle. Properly trained technicians have the equipment, tools, safety instructions, and know-how to do the job correctly and safely. If a condition is described, DO NOT assume that this Service Bulletin applies to your vehicle, or that your vehicle will have that condition.

SUBARU OF AMERICA, INC. IS ISO 14001 COMPLIANT

ISO 14001 is the international standard for excellence in Environmental Management Systems. Please recycle or dispose of automotive products in a manner that is friendly to our environment and in accordance with all local, state and federal laws and regulations.

ID	DESCRIPTION	QUANTITY
E	Weatherstrip Outer	1
F	EPT Foam Piece #1	1
G	EPT Foam Piece #2	1
H	Rivets	3
I	Non-Woven Tape	1
J	Butyl Tape	1

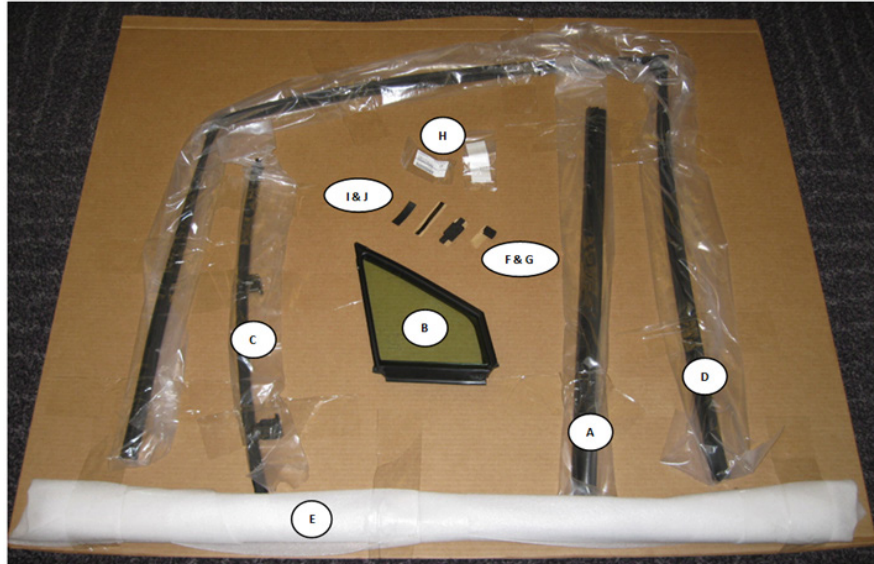

SERVICE PROCEDURE / INFORMATION

VERY IMPORTANT: Always verify the customer's concern and read through this procedure completely **BEFORE** proceeding with any repairs.

STEP 1 - Disassembly

IMPORTANT: Always take proper precautions to protect the door panel interior trim surfaces from becoming scratched / damaged throughout this procedure.

- Position the door glass 4" up from the top edge of the door trim panel.

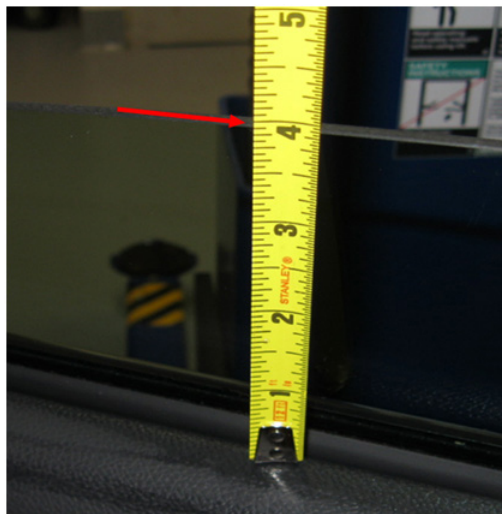

- Disconnect the battery ground (-) cable from the battery sensor.

Continued...

- **CAREFULLY** remove the affected door trim panel following the procedure outlined in the applicable Service Manual. Release the control cables from the inner door handle as shown in the photos below. Align the cable with the slot then lift up and out of the lever to disengage it.

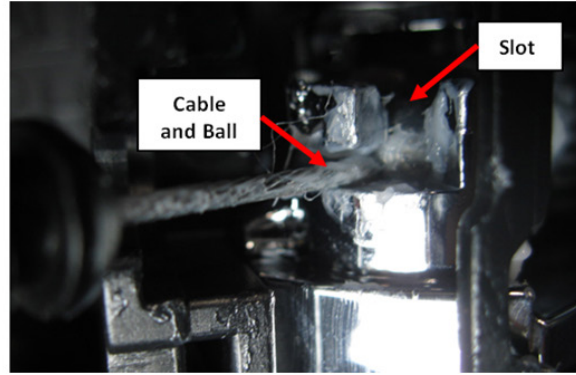
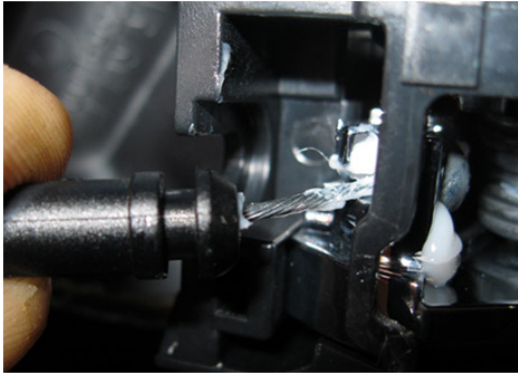

TIP: After disconnecting the control cables from the door handle, rotate the door panel 90 degrees clockwise as shown below. This will allow for much easier access to disconnect the door lock and power window switch harness connectors.



- After disconnecting the wiring harness connections for the power window and door lock switches, armrest pocket lamp, courtesy foot lamp and the speaker, put the trim panel in a safe place to protect it until needed.

NOTE: Pay close attention to the small sealing gaskets used on the door trim and pad insert retaining clips. These gaskets must be in place as shown below before reassembly to properly seal their respective component and help eliminate the possibility of a rattling sound.

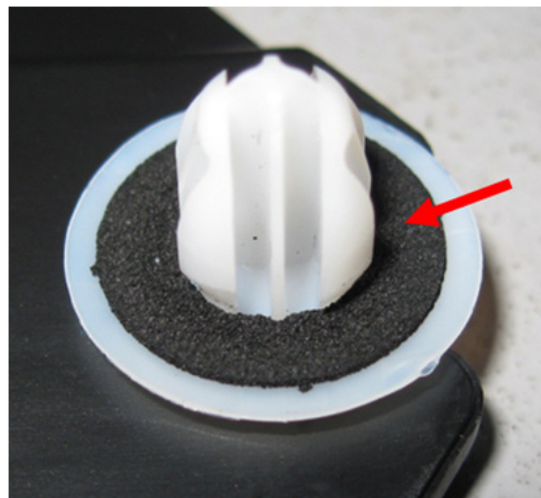

Continued...

- **CAREFULLY** release the vapor barrier from the bottom **only as much as is required** to remove the pad insert, access the window glass and sash retaining bolts and the wiring harness connections the inside door. Tape the vapor barrier to the undisturbed top portion to keep it out of the way. Using a trim clip removal tool, release the retaining clips and remove the plastic pad insert. Use a Philips screwdriver to remove the door speaker.



- As shown in the illustrations below, remove the 2- 10mm hex bolts securing the door glass to the window regulator. **CAREFULLY** tilt the glass toward the front as shown then lift to remove. Set the door glass aside in a safe place. Do not remove the window regulator assembly.

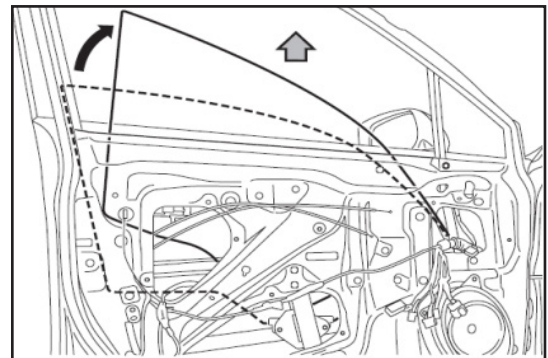
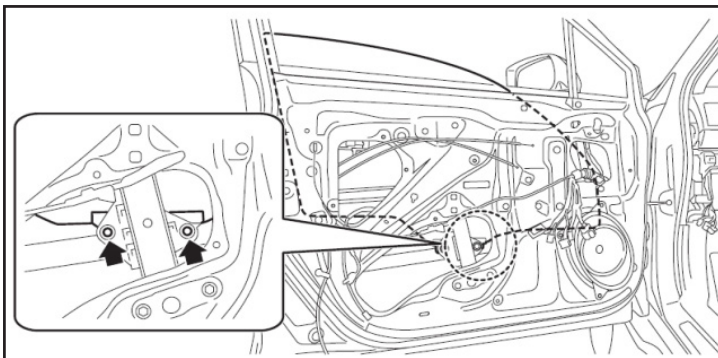

- Remove the #2 Philips screw securing the partition glass sash to the door frame. The screw is accessed by partially removing the outer door seal directly above where the sash meets the door frame. Remove the 2- 10mm hex bolts securing the sash to the inner door structure then remove the sash, partition glass and the run channel as shown in the illustrations below.

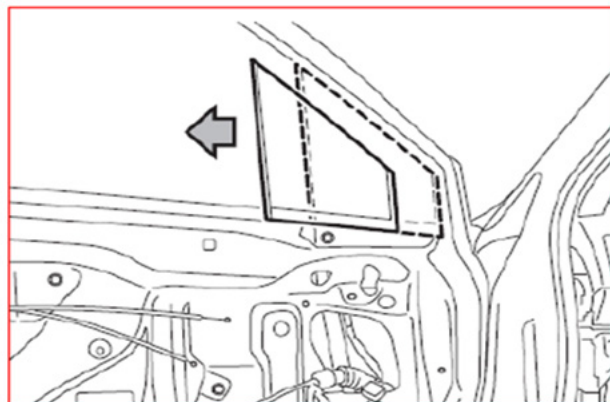
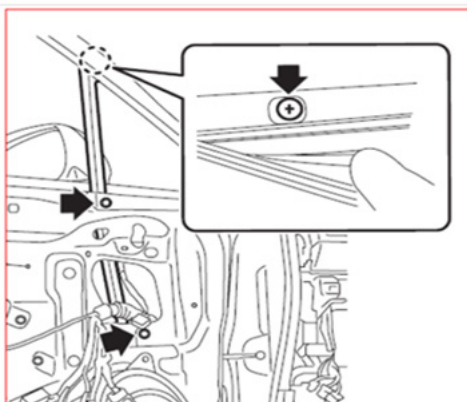

Continued...

NOTE: If the vehicle is equipped with the Genuine Subaru accessory Side Window Deflectors, (p.n. F0010AL500 - Outback or F0010AL900 - Legacy), the 2-sided tape securing the front leading edge of the front door deflector must be **CAREFULLY** cut in order to remove the sash. A thin, sharp utility knife or box cutter used in the photo below works well for this purpose. Once the sash is removed, remove the residual adhesive from the inside of the deflector using your fingers to “roll” it off then clean any remainder with a mild solvent on a clean shop cloth.



STEP 2 - Using a plastic trim tool under each end, **CAREFULLY** unseat the retaining clips and remove the outer door glass weatherstrip / chrome trim.

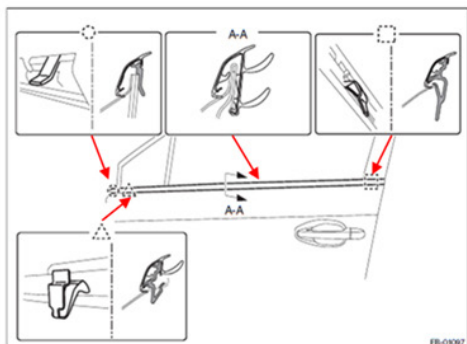

STEP 3 - Place the door trim panel on a clean surface (e.g. a blanket or cloth fender cover) and access the inner weatherstrip mounting claws. Use a small flat-blade screw driver to lift and straighten the retaining claws which along with “pop” rivets, secure it to the door trim panel. Note the direction of the metal retaining claws as the claws on the replacement part must be folded in the same direction as the originals. For example: on the front door, the 3 claws ahead of the center retaining rivet point toward the rear while the 3 claws behind the center rivet point toward the front.

Continued...

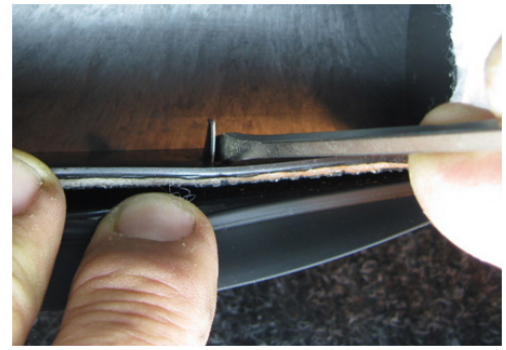
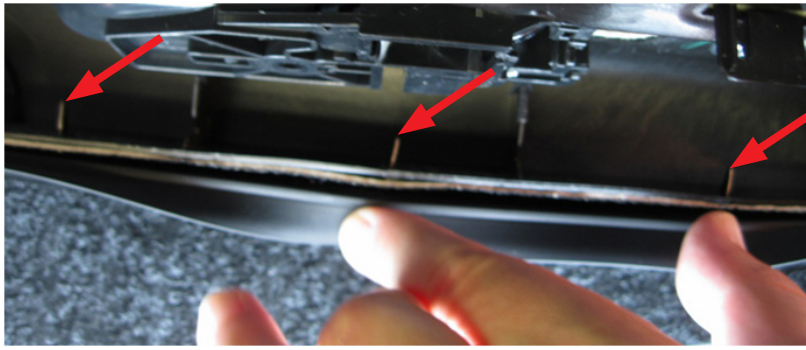

Using an electric drill with a 5/32" drill bit turning at **LOW SPEED**, **CAREFULLY** drill out the retaining rivets found between the "flaps" of the weatherstrip.

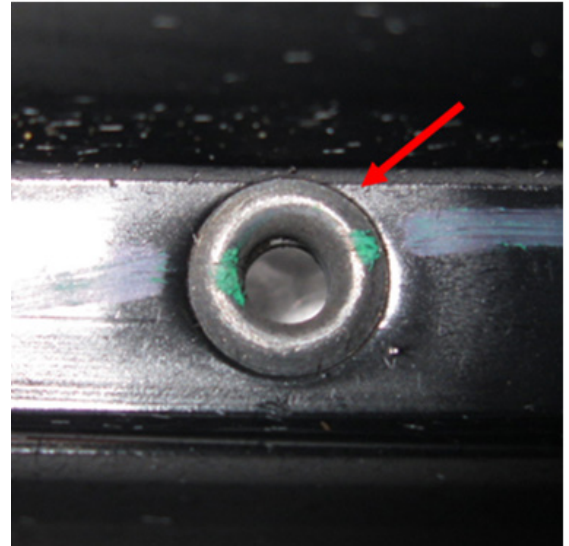
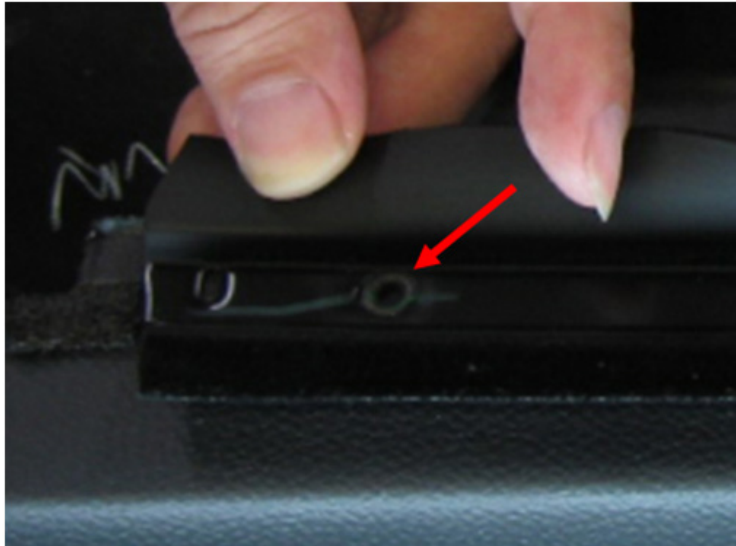

The photo below shows the drill being held at an angle to minimize the tendency for the rivet to spin. A 1/4" drive, 5mm deep-well socket was used as a drill stop and an additional "grip" to provide extra control of the drill bit while drilling out the rivets. Always make sure to vacuum away any remaining metal chips after drilling is complete.



Continued...

Fit the replacement inner weatherstrip to the trim panel. “Clamp” the new part to the door trim panel with your thumbs and fingers as shown below then bend the retaining claws over in the same direction as the originals (referenced earlier in this step) using your forefinger. The metal used for the backing and retaining claws of the weatherstrip is relatively pliable and easily bent into position.



Once all the new claws are bent over and holding the weatherstrip tight against the door panel, install the new retaining rivets using a pop rivet installation tool.



After installation, the back side of each new rivet will mushroom or “bloom” as shown below (Fig. 1). Pinch the inside flap of the weatherstrip and the lower glass-side flap together (Fig. 2). Using a pair of slip-joint pliers, **CAREFULLY** crush the bloom, one part at a time. The rivet material is aluminum so, only a small amount of clamping force is needed to achieve the desired result (Figs. 3 and 4). **They do not need to be crushed flat.** Maximum height is 3mm. Using the supplied piece of non-woven tape, cut it into thirds (3 pieces) and apply one piece over each rivet bloom (Fig. 4). Smooth the tape for proper adhesion.

Continued...

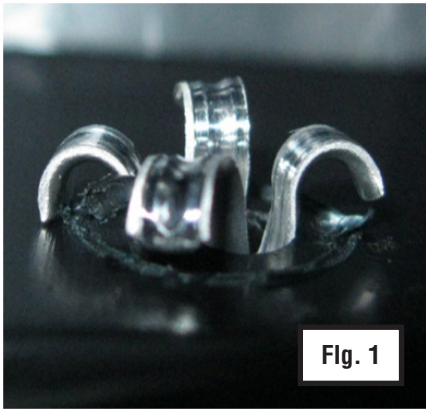

Fig. 1



Fig. 2

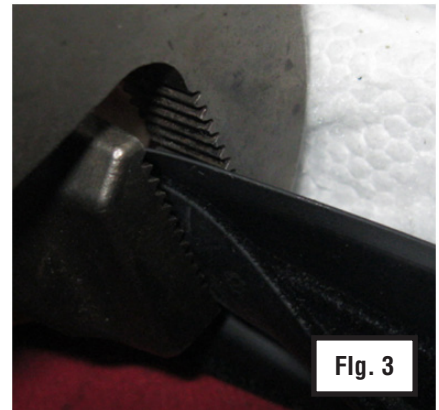

Fig. 3

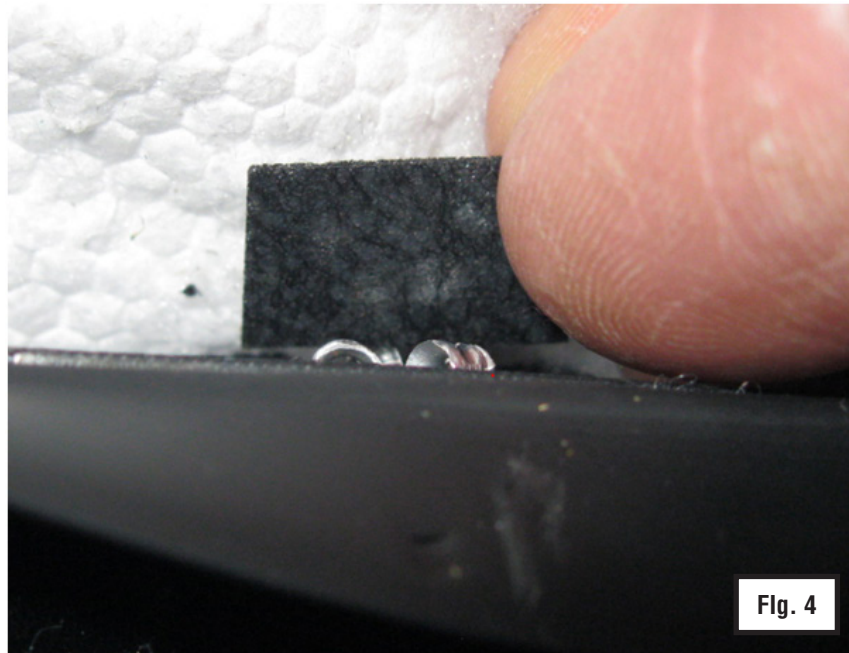
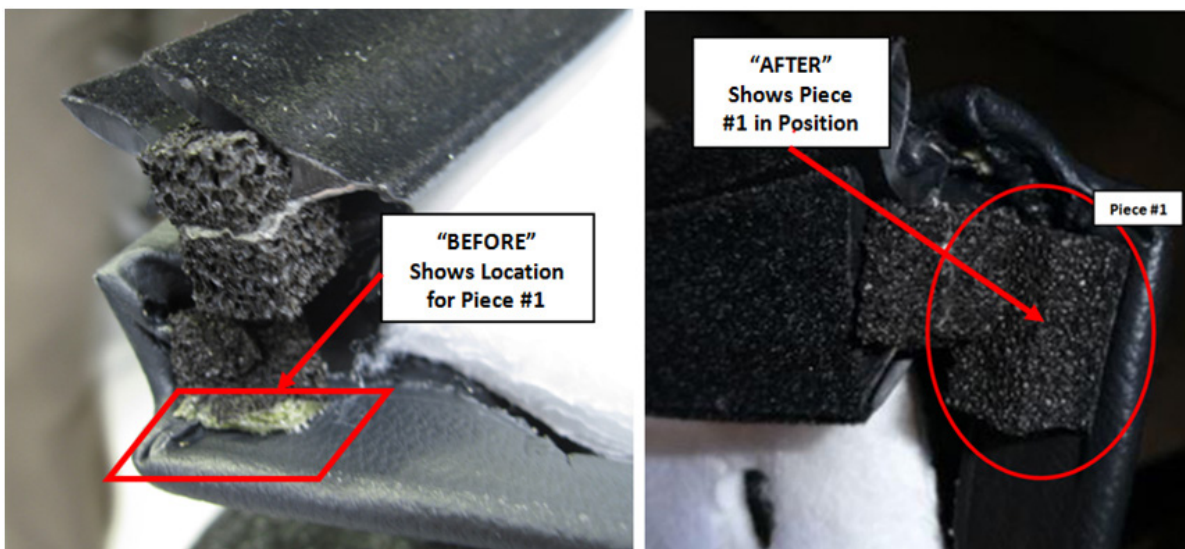

Fig. 4

STEP 4 - Application of the EPT Foam Sealing Material

- EPT Foam Piece #1 is applied to the door trim panel at the top rear corner where the trim material wraps around the back edge as shown in the “Before” and “After” photos below.



Continued...

- **EPT Foam Piece #2** is applied to the top front of the door trim panel at the front edge of the inner door glass inner weatherstrip. This piece seals the inside face of the sash and has been pre-cut so it can be properly folded into position as shown in the illustration and photos below.

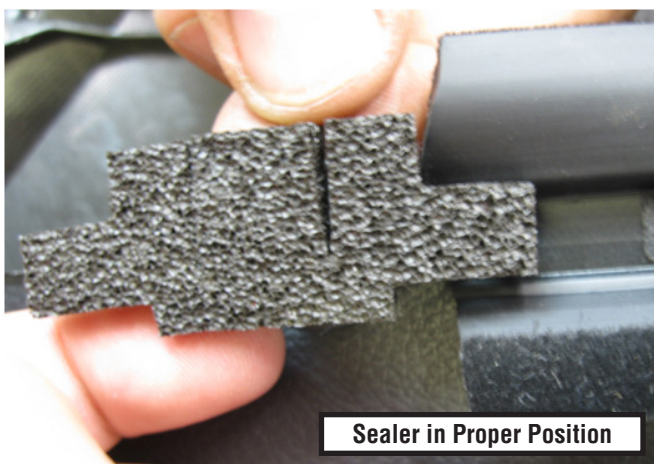
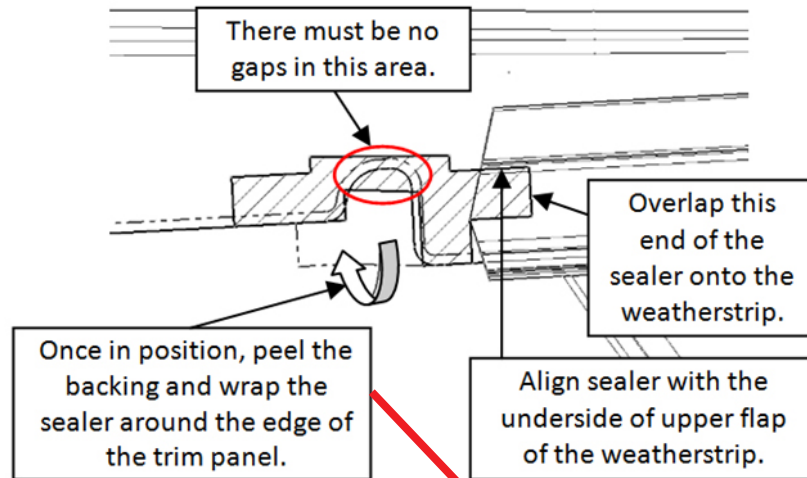
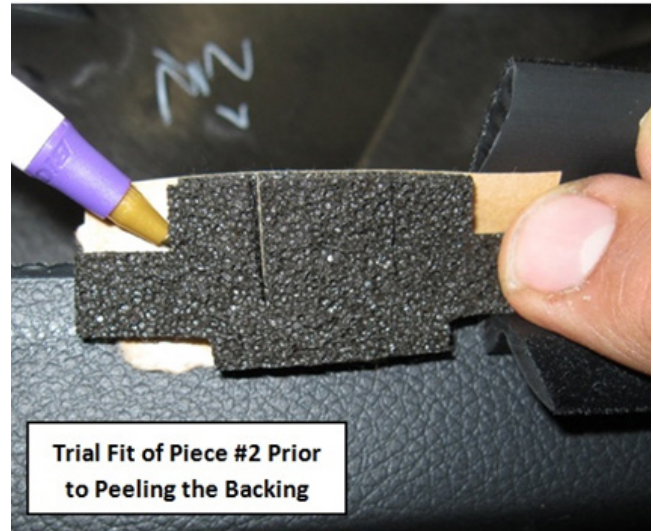

Continued...

STEP 5 - Application of Butyl Tape

- To better secure the **upper front corner of the REAR DOOR frame weatherstrip** to the door frame, release the plastic retaining clip and pull back the weatherstripping to gain access to the area where the butyl tape will be applied. Be sure to clean the area where the butyl tape will be applied with a mild solvent on a clean shop cloth. After drying the area completely, apply the 80mm long piece of butyl tape to the door frame as indicated in red in the illustration and shown in the completed installation photo below.

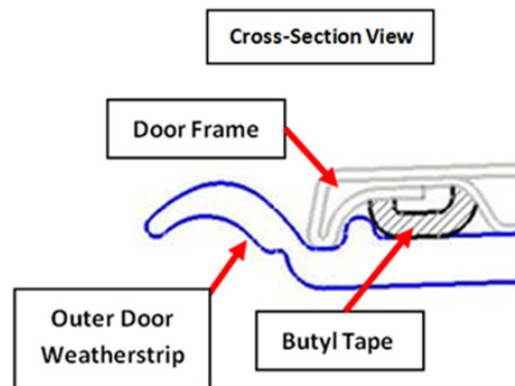
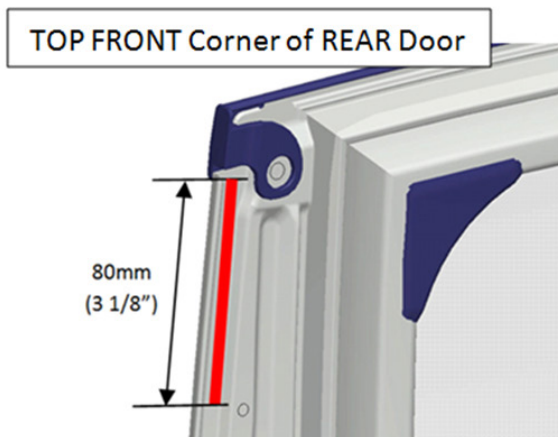
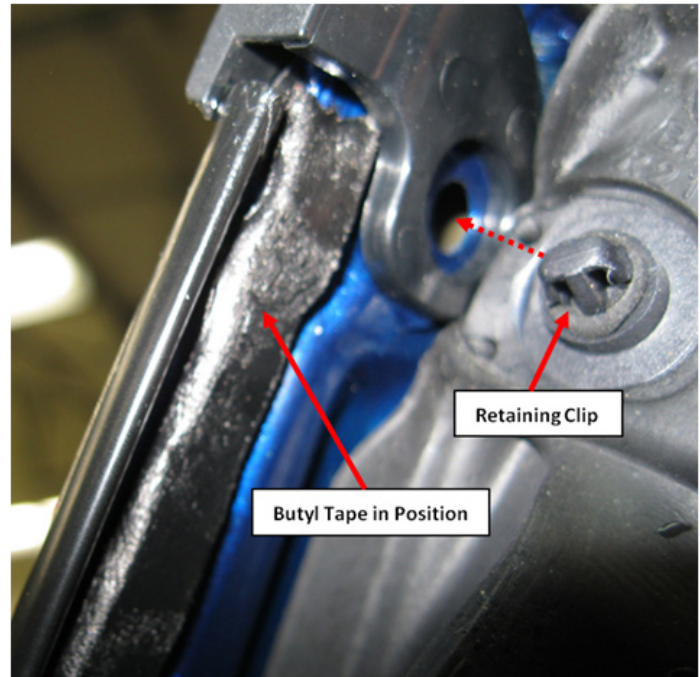

Continued...

After the butyl tape is applied, refit the weatherstrip and make sure the retaining clip “clips” back into the hole as shown to properly secure and position it. Work the weatherstrip onto the butyl tape with your thumbs making sure it is smooth and any bumps or high spots have been worked out.

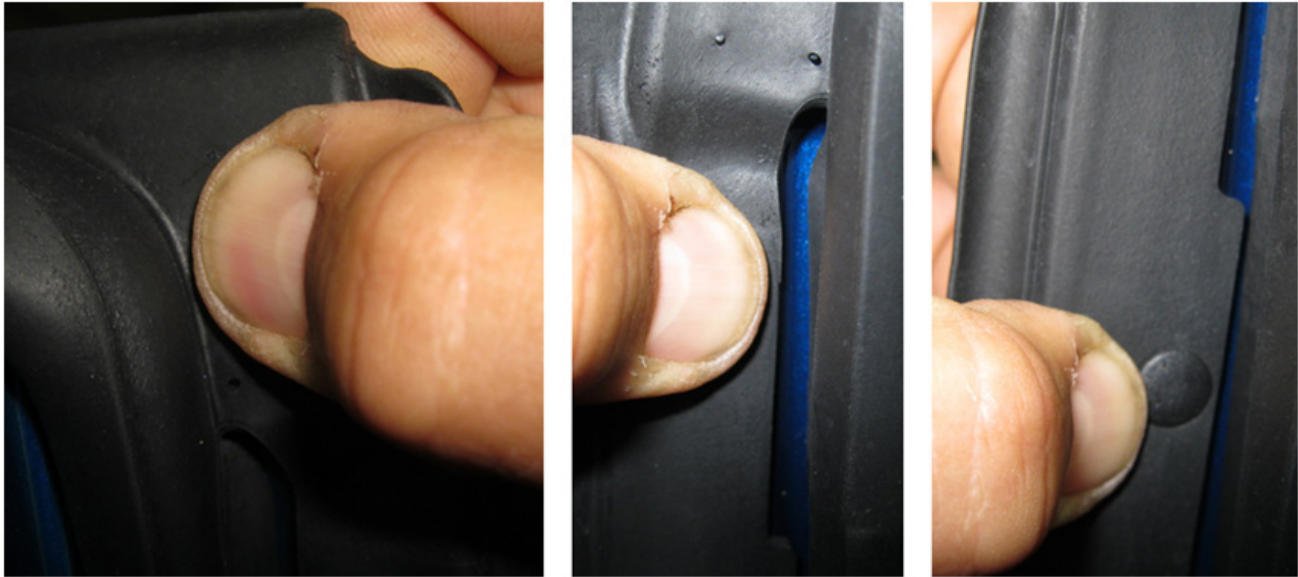

To complete this step, make sure the front of the weatherstrip is properly tucked in behind the chrome outer molding as shown below.

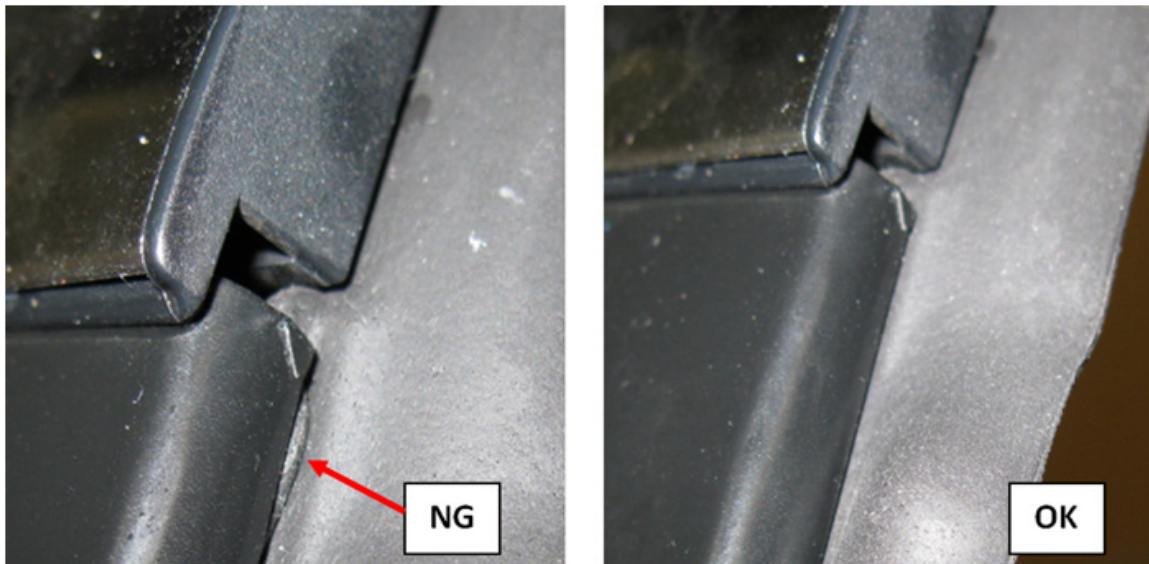

STEP 6 - Reassembly

- Install the new partition glass assembly, sash and glass run channel into the door frame in reverse order of removal.

IMPORTANT: Follow the torque sequence shown in the illustration below when reinstalling the sash into the door. While applying substantial forward pressure on the sash, fully torque the top Philips retaining screw to 1.6 ft. lbs. (19 inch pounds) then torque the 2- 10 mm hex sash retaining bolts to 5.5 ft. lbs (66 inch pounds), top bolt first. Do not snug the hardware then go back and final torque it. The initial tightening must be right up to the specified torque.

Continued...

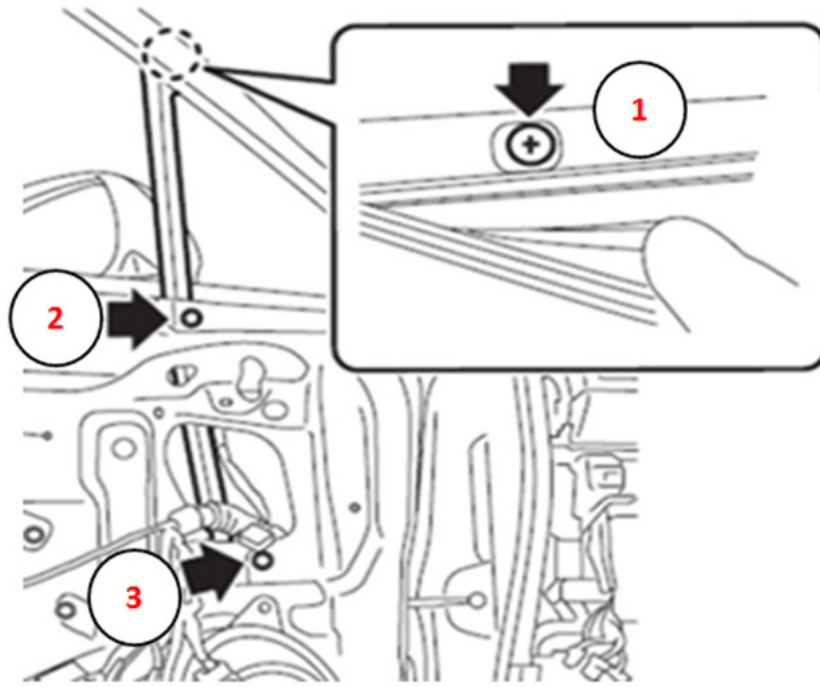

NOTE: If the vehicle is equipped with the Genuine Subaru accessory Side Window Deflectors, apply a new piece of double-sided mounting tape to the inside front edge of the deflector to re-attach it to the sash **BEFORE** installing the new sash back into the door. A small piece (2" long x 3/8" wide) of 3M .030" thick, Automotive Attachment Tape Part # 06377 (available from any auto body supply jobber) is recommended for this purpose. Leave the adhesive backing in place on the sash-side of the tape until the sash has been reinstalled. Once the sash is in its final position and fasteners properly torqued, pull the deflector out enough to access the sash-side backing of the tape. Peel the backing and press the deflector onto the new sash securing it in place.

- Remove the original glass run channel. When installing the new glass run channel, make sure to apply pressure in the direction of the arrows shown in the illustration below making sure it is **fully seated** into the door frame, paying close attention to the upper rear corner. It is also important to confirm the run channel is completely seated all the way to the bottom in both the new sash (front) and the channel it fits into at the rear edge of the glass.

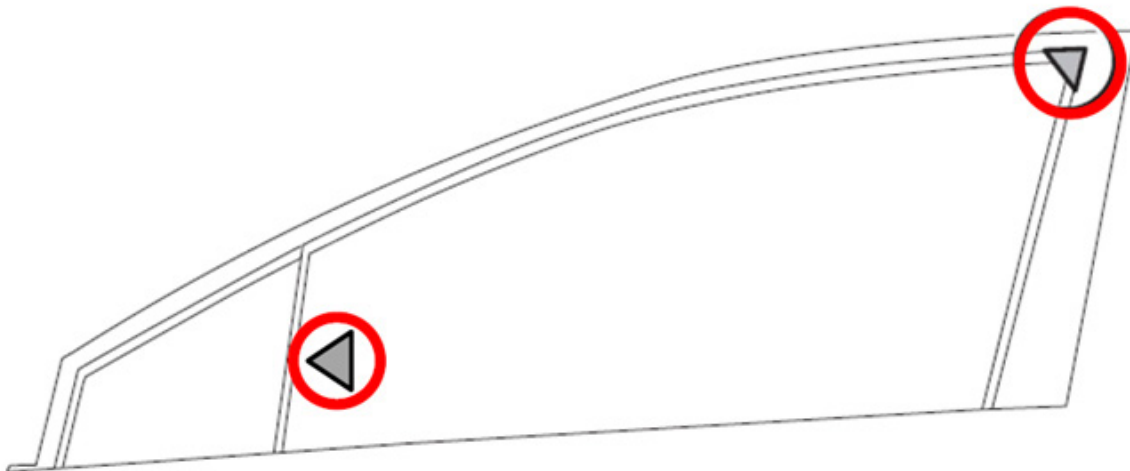

Continued...

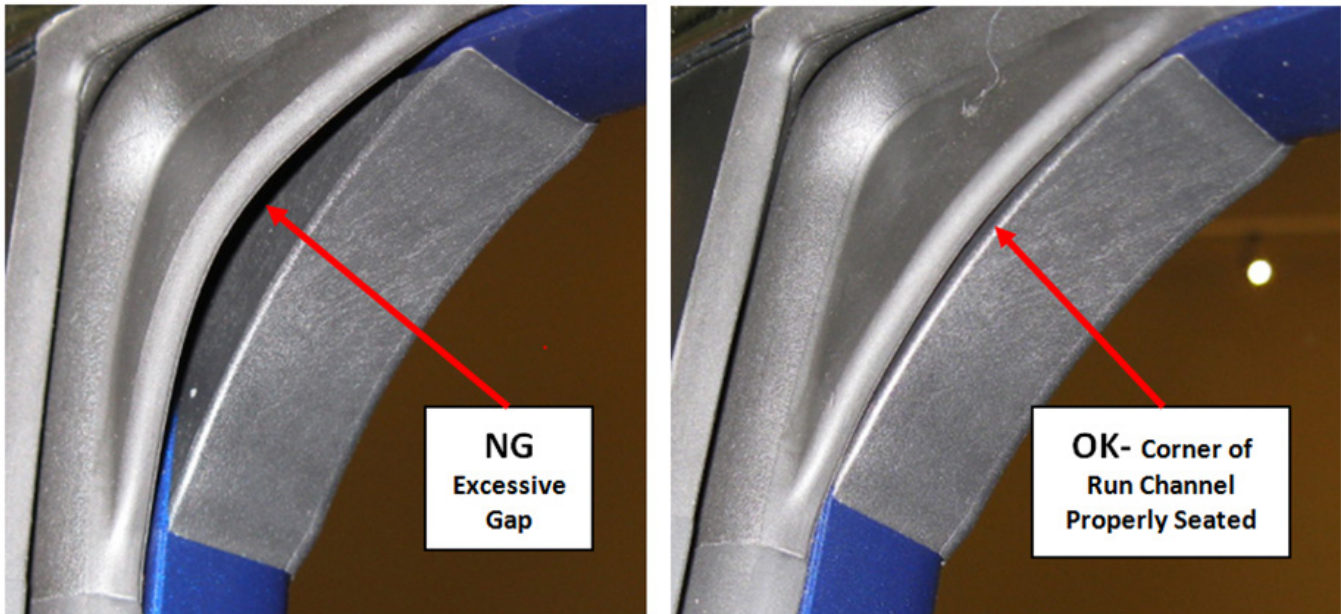

- **CAREFULLY** reinstall the door glass into the new glass run channel and slide it down to meet the regulator. Reinstall the 2 mounting bolts and torque to 5.5 ft. lbs. (66 inch pounds).
- Reinstall the pad insert then refit the vapor barrier making sure it is properly sealed as it was prior to the repair. Reinstall the door speaker.
- Reconnect the door lock and latch control cables and all removed wiring harness connectors.

IMPORTANT: When reinstalling the door lock and latch control cables, always make sure the outer casings are fully locked back into place in their respective retaining grooves.

- Always verify proper power window, power door lock, door latch, armrest pocket lamp, courtesy foot lamp and speaker operation before final installation of the door trim panel.
- Once proper operation is confirmed, complete the installation of the door trim panel in reverse order of removal.

IMPORTANT: To prevent EPT Foam Piece #1 from binding or “bunching up”, hold the lower part of the door trim panel away from the door while sliding it down into position.

STEP 7 - Install the new replacement outer door weatherstrip / chrome trim in reverse order of removal as outlined previously in **STEP 3**.

STEP 8 - Reconnect the negative battery cable and torque the 12mm nut to 7.5 Nm (5.5 ft. lbs).

Continued...

NOTE: For the power window Auto Up / Down feature to operate, the system will need to be re-initialized, regardless of which front door was repaired. Always confirm Auto Up / Down feature is working on **BOTH** front windows after reassembly. Follow the steps below to complete the re-initialization procedure:

1. Begin with the window fully closed. Push the switch down to open the window about halfway.
2. Pull the switch up to close the window fully in steps (it will only close about 2” each time the switch is operated).
3. Once the window is fully closed, pull up and hold the switch again for 1 second to complete the initialization procedure.

STEP 9 - Road test the vehicle to confirm the repair has been successful to complete the procedure.

WARRANTY / CLAIM INFORMATION

For vehicles within the Basic New Car Limited and / or Powertrain Warranty period, this repair may be claimed using the following information:

LABOR DESCRIPTION	LABOR OPERATION #	FAIL CODE	LABOR TIME
2015 Legacy and Outback Front Door Wind Rushing Sound Repair- 1 Side	B912-503	WAZ-48	1.1
2015 Legacy and Outback Front Door Wind Rushing Sound Repair- Both Sides	B912-504		1.7
Models With Side Window Air Deflectors (Add this labor operation ONE TIME for each side.)	C912-505		0.1

NOTE: Up to \$1.00 can be claimed in sublet to cover the cost of the Attachment Tape where applicable.

REMINDER: SOA strongly discourages the printing and/or local storage of service information as previously released information and electronic publications may be updated at any time.

Always refer to STIS for the latest service information before performing any repairs.