



<b>Countries:</b>	AUSTRALIA, CANADA, UNITED STATES, MEXICO, PUERTO RICO	<b>Document ID:</b>	IK1201113
<b>Availability:</b>	ISIS, FleetISIS	<b>Revision:</b>	5
<b>Major System:</b>	ENGINES	<b>Created:</b>	4/3/2014
<b>Current Language:</b>	English	<b>Last Modified:</b>	7/22/2014
<b>Other Languages:</b>	NONE	<b>Author:</b>	Aaron Wenthold
<b>Viewed:</b>	2472		

[Less Info](#)

Hide Details

Coding Information

<b>Copy Link</b> 	<b>Copy Relative Link</b> 	<b>Bookmark</b>  <a href="#">View My Bookmarks</a>	<b>Add to Favorites</b> 	<b>Print</b> 	<b>Provide Feedback</b> 	<b>Helpful</b>  21	<b>Not Helpful</b>  1
----------------------	-------------------------------	--	-----------------------------	------------------	-----------------------------	--------------------------	-----------------------------

**Title: 2010 MaxxFORCE 11 & 13 and 2013 N13 HT EGR Core Removal/Installation**

**Applies To: 2010 MaxxFORCE11/13, 2013 N13, All Truck Models**

**NOTICE:** Some HT kits were mis-built, and are missing critical components. Until the kits are remedied, please source additional core extraction screws local or from the tool kit (No. 12 Hex washer head screw, 1-1/2 inch long). The missing crossover tube seal (3018586C1) should be in dealer inventory or is available from the PDCs.

## **CHANGE LOG**

2014/07/22 - Added link/instructions to repair video in LMS ("Repair Procedure")  
 2014/07/16 - Added note about ensuring o-ring grooves are debris free (installation step 1). Updated SRT for half section replacement  
 2014/07/14 - Fixed P/Ns for N13 LT module and LT seal kit. Added comment about module replacement SRT including all diagnostics.  
 2014/07/11 - Fixed SRTs to reflect recent publication  
 2014/07/09 - Added (temporarily) notice about shops log regarding mis-built kits

## **DESCRIPTION**

A faster, more effective procedure for High Temp (HT) Exhaust Gas Recirculation (EGR) Cooler repair has been developed. This document will guide the user through the procedure of in chassis replacement of the cooler core for a 2010 Emissions MaxxFORCE 11 or 13 or 2013 Emissions N13. The new procedure will **REPLACE** HT cooler assembly replacement for **INTERNAL** leaks.

Please note, if the LT is being repaired with a High Temp (HT) replacement, reference [iKNOW 1201100](#) for LT core replacement instructions.

It is important to thoroughly review the following instructions to prevent tool damage. A lot as been learned through the development of the tool, and important notes/areas of concern are specifically called out at relevant points.

## **SYMPTOMS**

**Diagnostic Trouble Codes & Dashboard Indicator Lights:**

DTC/Light	Description
<a href="#">SPN 111 FMI 1</a>	Low Coolant
<a href="#">SPN 2659 FMI 21</a>	EGR Low Flow
	Malfunction Indicator Light (MIL)
	Red Stop Lamp (RSL)

**Customer Observations or Concerns:**

- Malfunction Indicator Light (MIL)
- Red Stop Lamp (RSL)
- Coolant consumption
- Low coolant
- Coolant puddling under engine
- White smoke from the exhaust
- Coolant in the oil or oil analysis

**SPECIAL TOOLS**

Tool Description	Tool Number	Comments	Instructions
LT Core Replacement Tool	12-892-04		<a href="#">Link</a>
HT Core Replacement Tool	12-892-05		<a href="#">Link</a>
Coolant Management Tool	KL5007NAV		<a href="#">Link</a>
EGR Leak Detection Kit	12-892-02		<a href="#">Link</a>

**DIAGNOSTIC STEPS**

All diagnostic steps should be completed through the [Fault Code Action Plans](#) for [111-1 or Coolant Consumption/Loss](#). At this point, the truck should have been diagnosed with an internal leak of the HT cooler.

**REPAIR NOTES:**

- The following procedure should **NOT BE USED** if the cooler is **LEAKING EXTERNALLY** for cracks, porosity, broken fittings, etc. Instead, replace the entire HT cooler assembly.
- If the cooler is leaking at the joint between the HT and the center plate, replace the HT assembly.
- If leaking between the center plate and the LT assembly, reference the LT seal kit in the parts section.
- If leaking from the LT Y-Fitting (only if the fitting is bolt-on), reference the LT Y-Fitting kit.

**TESTING NOTE**

If **BOTH** cooler halves are found leaking, make sure the LT cooler did not appear failed due to residual air in the core from the High Temp testing. Typically this happens when the leak detection hose is not vented to atmosphere (left in water) between tests and/or when the HT is tested and the fittings are switched quickly--the air pressure in the core passages is still enough to cause bubbles when putting pressure to the LT.

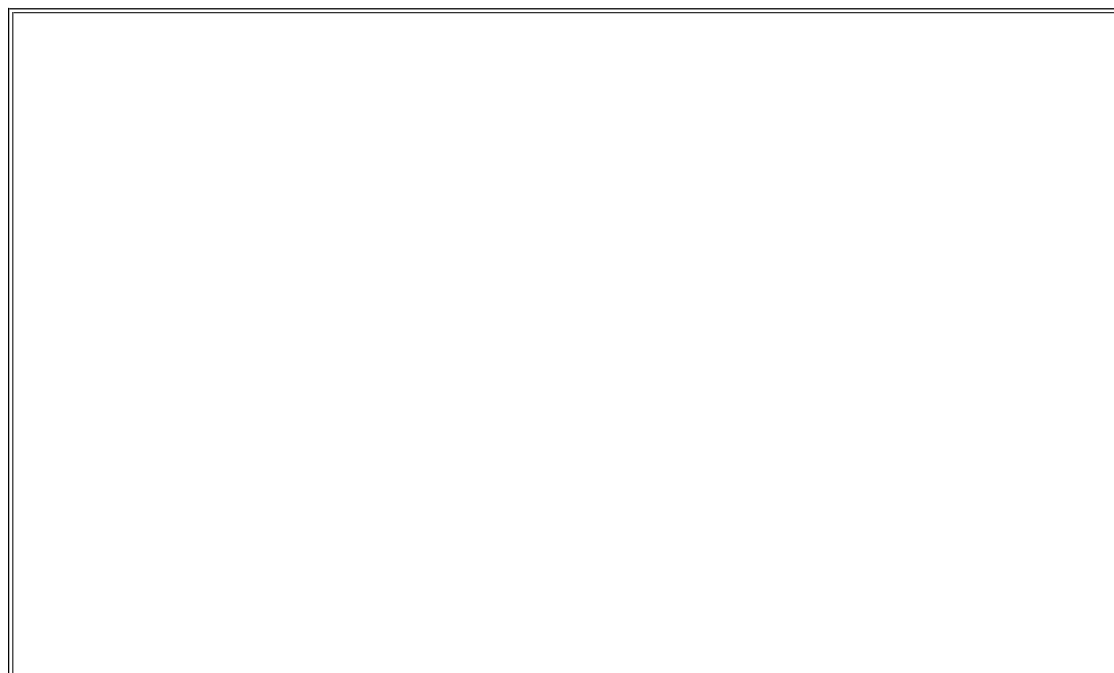

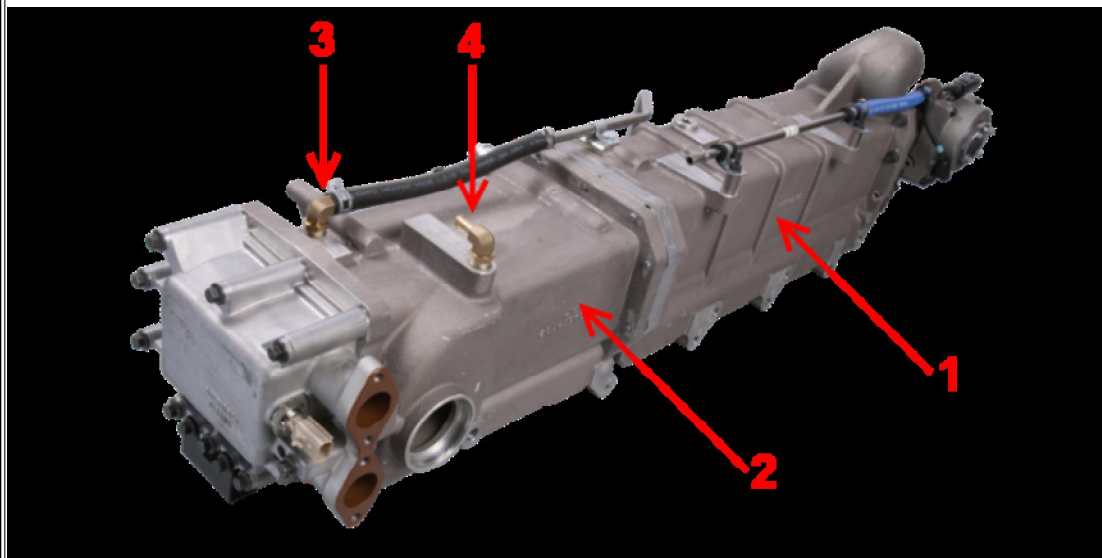

**Figure 1: 2010 MaxxForce 11/13 EGR Cooler Assembly**

- Item 1: High Temp (HT) Cooler
- Item 2: Low Temp (LT) Cooler
- Item 3: LT Cooler Pressure Test Port (dearation fitting)
- Item 4: HT Cooler Pressure Test Port (dearation fitting)

## **SERVICE PARTS INFORMATION**

Kit Description	Part Number	Quantity Required	Notes
Kit, High Temp Core	2513445C91	1	Required
Kit, Low Temp Core	2513209C91	1	ONLY if necessary
Module, HT	3014254C95	1	ONLY if necessary
Module, LT (MaxxForce)	3015862C92	1	For external leaks ONLY, in place of LT Kit
Module, LT (N13)	2511089C91	1	For external leaks ONLY, in place of LT Kit
Kit, Low Temp Seal	2512193C91	1	For external leaks between the LT and the plate
Kit, Y-Fitting (Low Temp)	1844447C1		For leaks at LT Y-Fitting (bolt-on ONLY)
P-80 Assembly Lube	2511097C1	1	Case of 6 Pints

## **REPAIR STEPS**

### **REPAIR VIDEO**

The entire repair procedure has been put into video and available in the Learning Management System. [Go to the LMS via this link](#). Then "Course Catalog," "Critical Repair Videos," "HT EGR Cooler Core Replacement Procedure," and enroll. After enrolling, go back to "My Current Enrollments" to watch. If you do not see the same link in the course catalog, do a search (Ctrl "F") and search for "HT EGR Cooler Core Replacement Procedure."

The following repair steps are for the cooler removal and installation in chassis.

#### **WARNING**

To prevent personal injury or death, read all safety instructions in the "Safety Information" section of the diagnostic manual, [linked here](#).

#### **WARNING**

To prevent personal injury or death, shift transmission to park or neutral, set parking brake, and block wheels before doing diagnostic or service procedures.

#### **WARNING**

To prevent personal injury or death, make sure the engine has cooled before removing components.

#### **WARNING**

To prevent personal injury or death, do not let engine fluids stay on your skin. Clean skin and nails using hand cleaner and wash with soap and water. Wash or discard clothing and rags contaminated with engine fluids.

### **REMOVAL PROCEDURE:**

The dog house, coolant crossover and EGR tubes should have already been removed to gain access to the cooler for pressure testing.

1. Remove and discard the 9 bolts securing the EGR Valve to the HT cooler housing.
2. Remove the two dowel pins in the top right and bottom left corner of the housing.
3. Discard the EGR valve to cooler gasket.
4. Install the removal tool

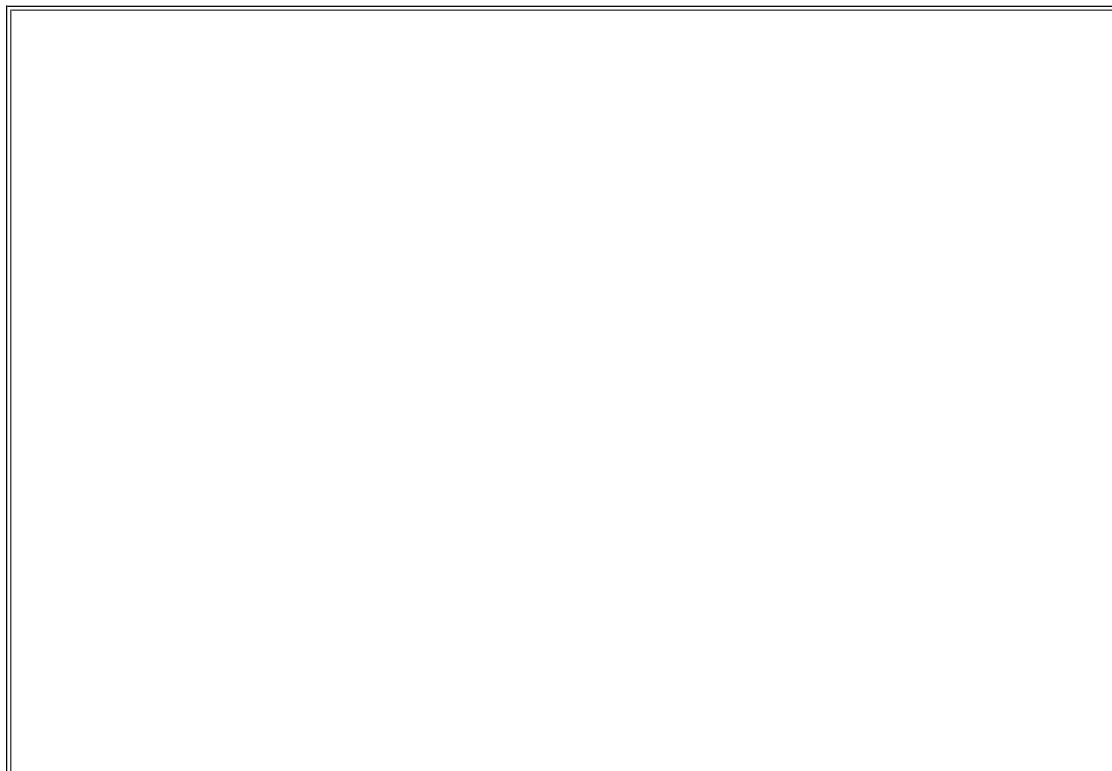

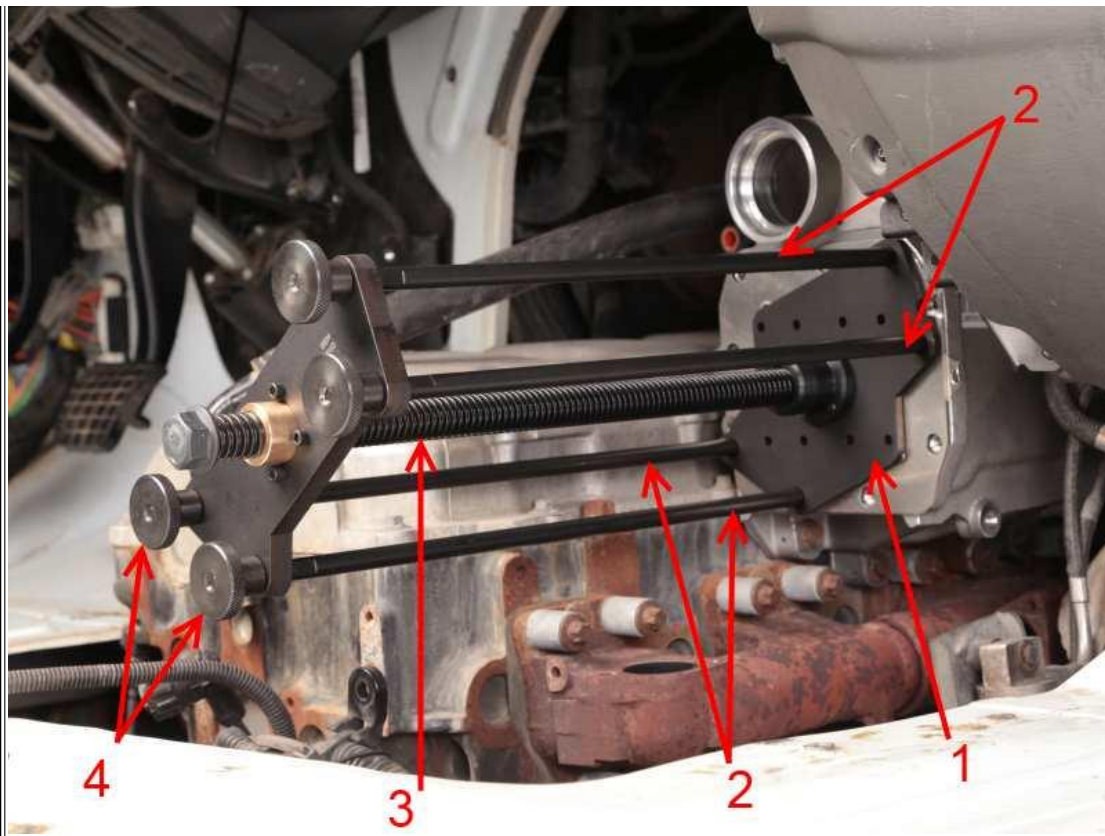

**Figure 2: HT Core Removal Tool**

- Item 1: Removal plate
- Item 2: Support rods
- Item 3: Forcing screw
- Item 4: Thumb screws

a. Screw in the support rods in the two upper right, and lower, bottom left corner, holes (**Figure 2**, Item 2). **Tighten using a 9mm open-end wrench.**

**WARNING**

It is critical that the rods get torqued to the housing. There is a bevel between the threads and the shaft, designed specifically to drive the cooler header onto the shaft. Failure to do so will lead to the header being caught on the rod and breaking/bending the rod. There have been instances of the housing being damaged to the point of replacement, as well.

- b. Slide the puller over the rods
- c. Attach/tighten the thumb screws (**Figure 2**, Item 4).

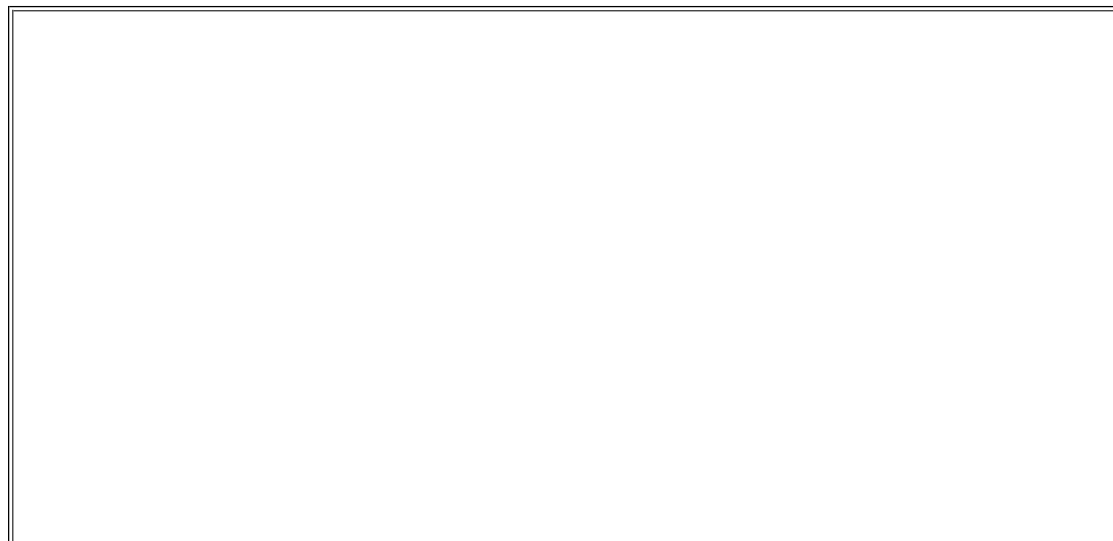
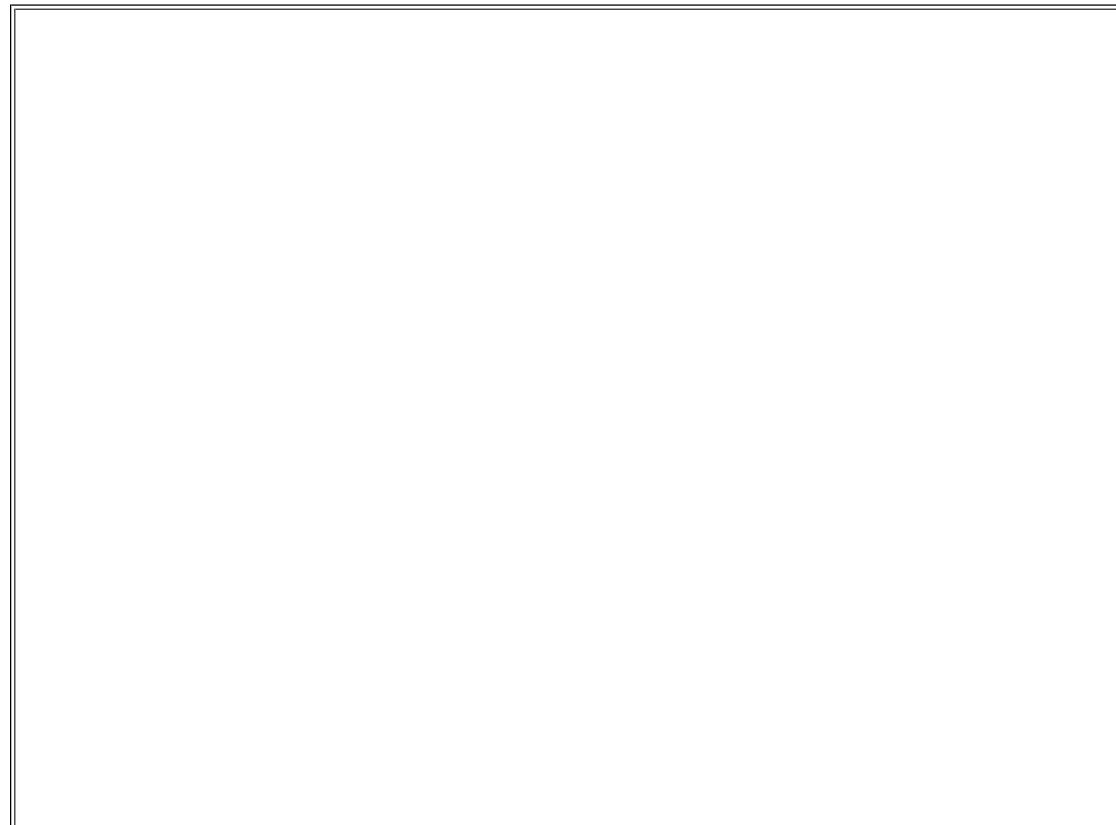

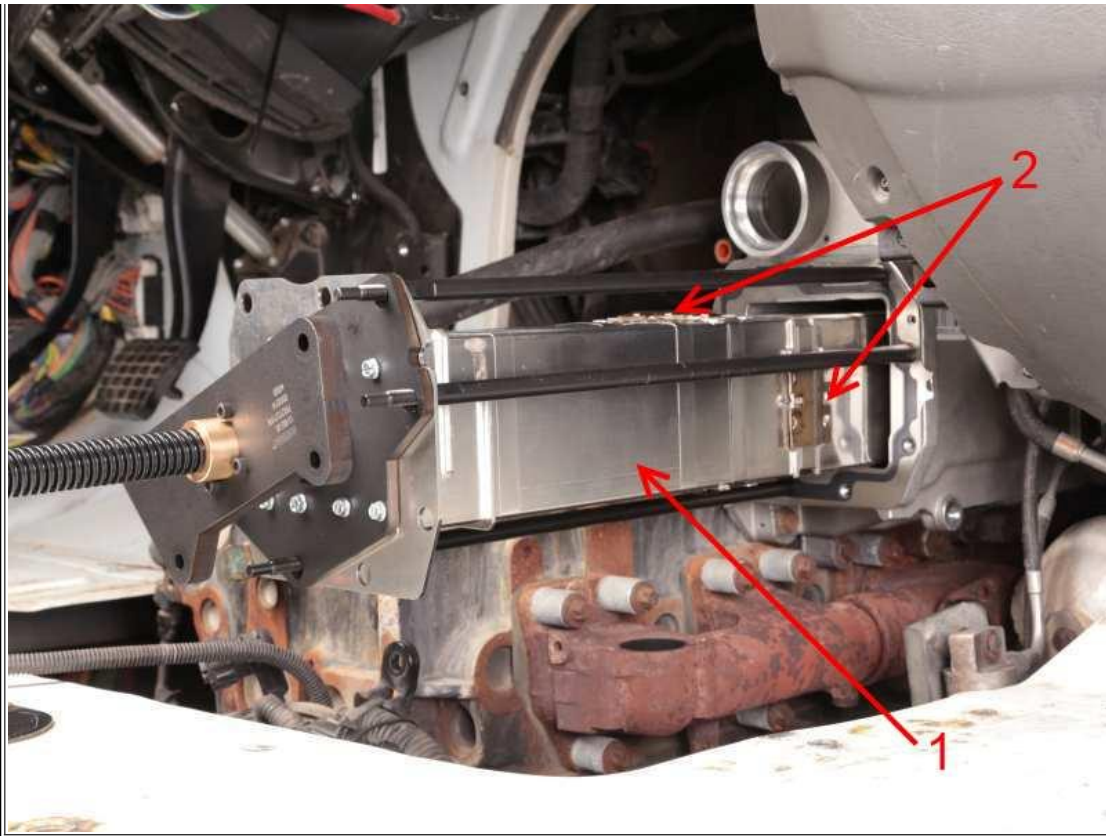

Figure 3: HT Core Tool Plate with Screws

d. Lastly screw the removal plate into the core using the eight screws supplied in the HT kit (Figure 3).

Reference the HT Tool Instructions ([12-892-5, TL2900093](#)) for more information.





**Figure 4: High Temp Core and Spring Clips**

Item 1: HT Cooler Core  
 Item 2: Spring Clips

5. Back out the bolt to extract the core from the housing (**counter-clockwise**).

There are two pairs of spring clips supporting the core in the housing. Therefore, the core will need to be pulled about 16 inches before it will be free to remove.

6. Unscrew the knobs from the rods.
7. Remove the cooler core from the housing.
8. Unscrew the screws from the removal plate/core and discard.
9. Unscrew the rods to remove the gasket (discard).

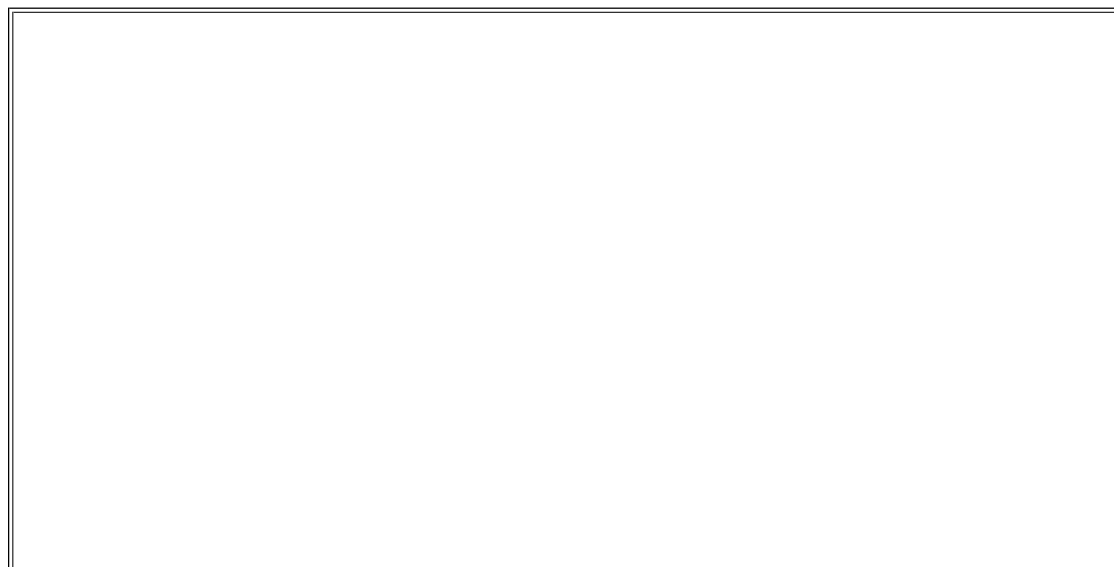

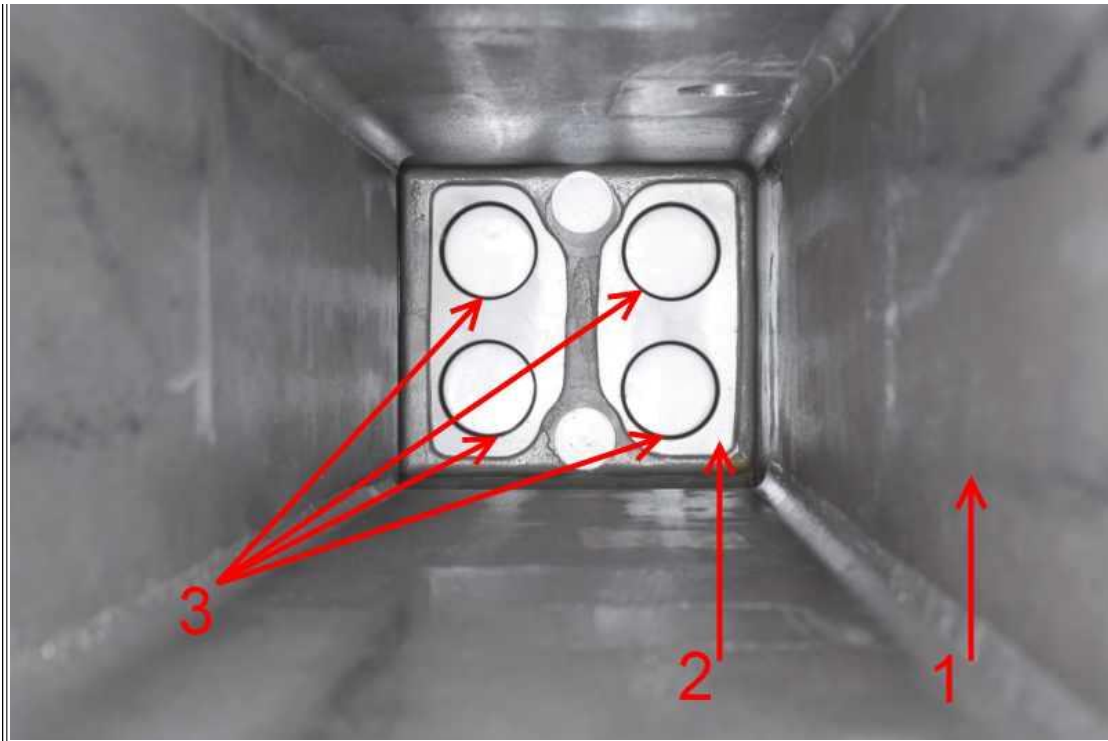
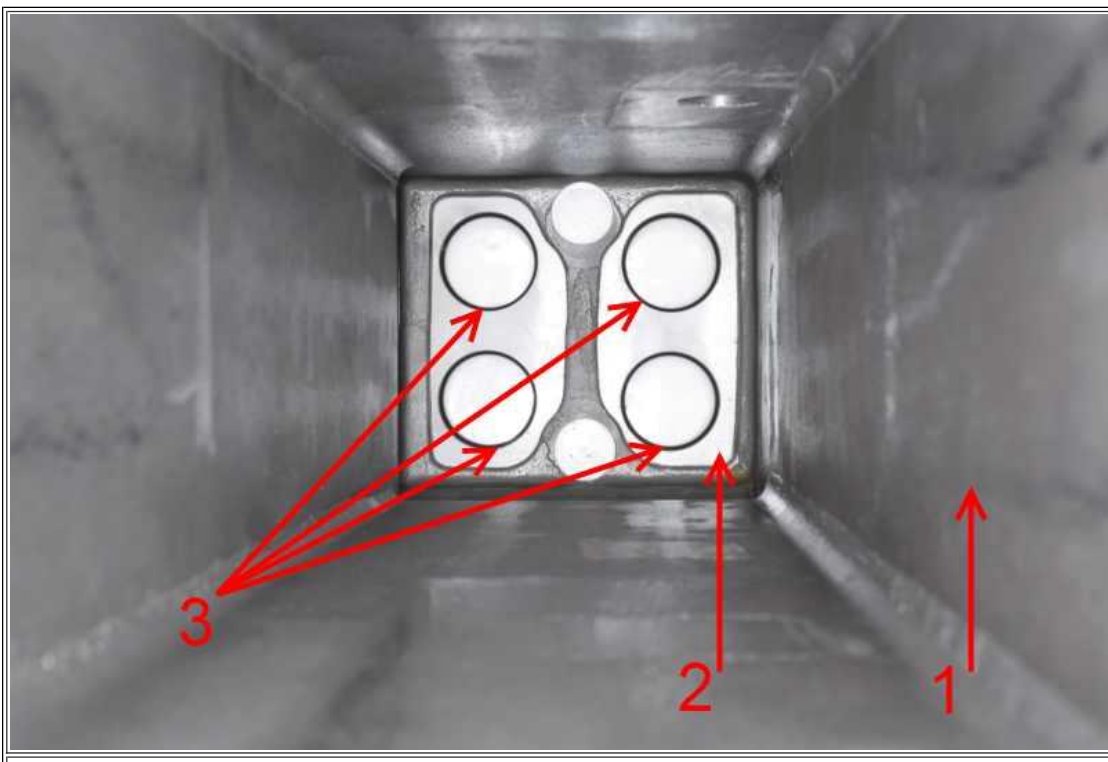

Figure 5: HT Diffuser O-Rings

- Item 1: HT Housing
- Item 2: Manifold (joint) Plate
- Item 3: O-Rings

10. Use a pick to remove the four o-rings in the center of the cooler and discard. *The o-rings must be replaced every time the core is replaced. Non-compliance will result in premature failure of the core.*

**INSTALLATION PROCEDURE:**



**Figure 6: HT Diffuser O-Rings**

- Item 1: HT Housing
- Item 2: Manifold (joint) Plate
- Item 3: O-Rings

1. Install the four o-rings from the HT kit (**Figure 6**, Item 3) and ensure they are seated properly.

**NOTE**

**Make sure there is no debris in the o-ring grooves prior to installing the o-rings** (they don't need to be spotless, just no soot chunks that will push the o-ring out of round). In development, this was the only instance of damaged o-rings (core outlet manifold cut off a section of the o-ring), outside of not actually seating them.



**Figure 7: Cooler Core Kit O-Rings**

**WARNING**

There are two o-ring designs and both are the same size with different durometers. Make sure to use only the black o-rings on the HT core and pink o-rings on the LT core.

2. Apply generous amounts of P-80 to the four o-rings.
3. Install the two dowel pins into the housing. Use a hammer to tap them in, if necessary.
4. Install the core to housing gasket.
5. Screw in the four rods from the tool kit (tighten using a 9mm open-end wrench).



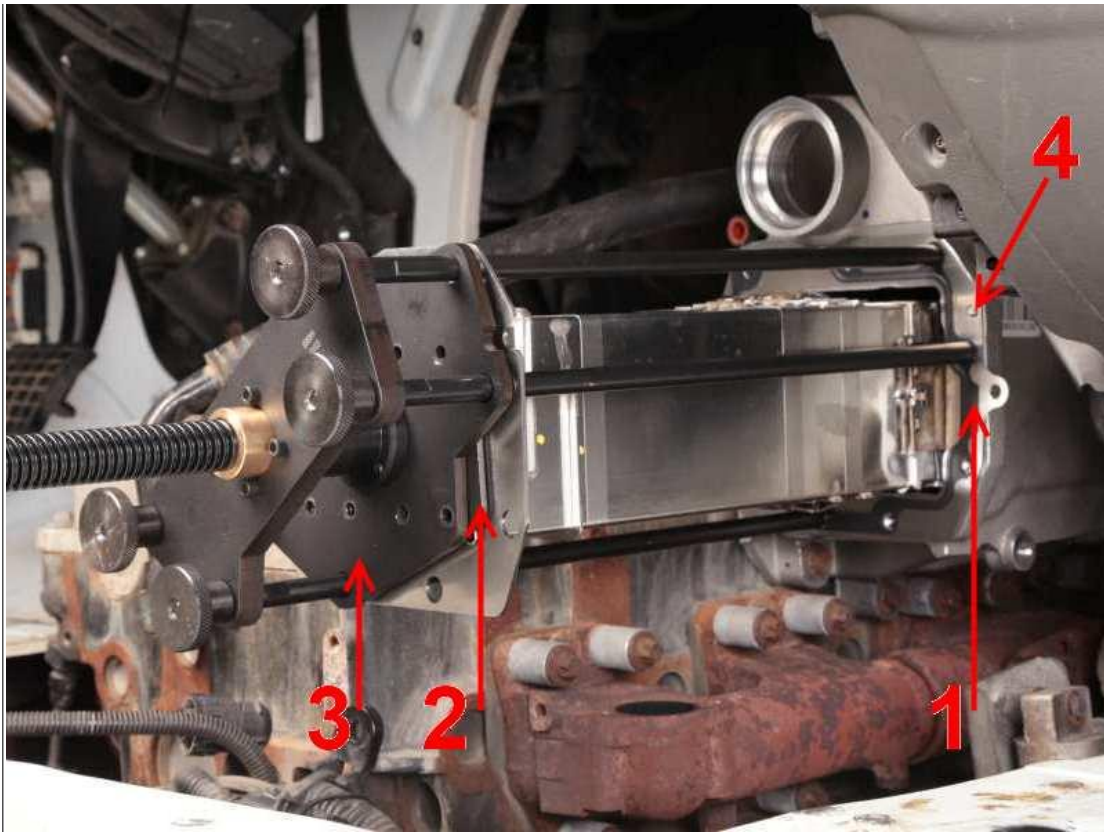

**Figure 8: HT Core Installation**

- Item 1: Core to Housing Gasket
- Item 2: Installation Plate
- Item 3: Removal Plate
- Item 4: Dowel Pin

6. Apply liberal amounts of P-80 to the outlet manifold and spring clips of the HT core.
7. Slide the HT Core into the housing.
8. Attach the insertion plate to the tool and slide it over the rods.
9. Screw the thumbscrews onto the rods.
10. Use a torque wrench to tighten the bolt, which will drive the core into the housing. Stop when the core header touches the gasket.

**NOTE**

**DO NOT OVER TIGHTEN.** Stop when the plate merely touches the gasket/housing. The core should take up to 10 lb-ft of bolt torque to slide in. **Damage to the tubes will occur if the torque exceeds 15 lb-ft (equates to 1000 lb force).**

11. Remove the knobs, tool and rods.
12. Install the EGR Valve gasket.

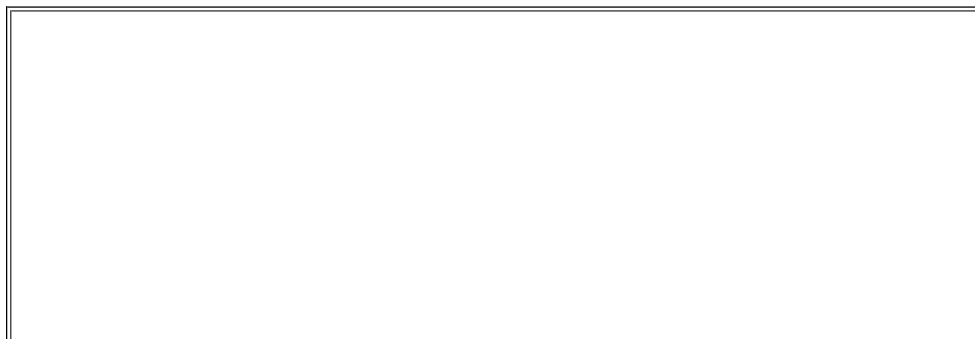

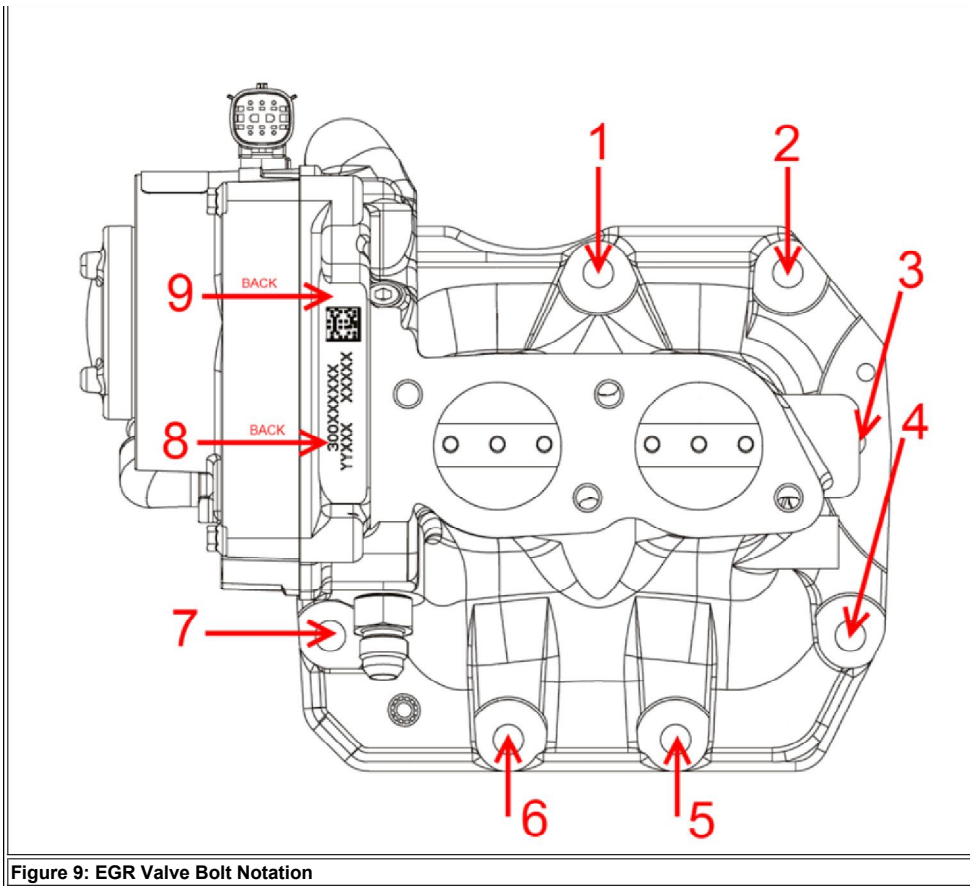

Figure 9: EGR Valve Bolt Notation

13. Install the EGR valve and torque as follows, referencing Figure X for bolt position notation.
  - a. Hand tighten all
  - b. Torque "1-5-7-4" to 5 N-m (4 lb-ft)
  - c. Torque "5-1-6-2-7-3-4-8-9" to 24 N-m (18 lb-ft)
14. Attach all coolant lines for cooling system refill. Do not begin truck reassembly yet.
15. Perform vacuum fill of the cooling system while watching for an inability to maintain vacuum.

**NOTE**

If the system is unable to maintain vacuum, perform a cooling system pressure decay test. If no external leaks can be found, pressure test the EGR Cooler using the leak detection tool. The vacuum fill is a critical aspect of the repair. Any issues (cut/damaged/missing o-rings) will be caught here, as well as ensuring no air pockets are left in the system (which can reduce the life of the cooler or make the system appear leaking as the pockets are burped). If there is no choice but to use the bucket fill method, it will be CRITICAL to pressure test the cooling system after the repair.

16. Assemble the remaining components removed for pressure testing
17. Per best practice, verify repair.

**For an internal leaking cooler**

Replace the engine oil and filter for coolant contamination and follow iKNow [IK1201065](#) for Lambda Sensor Relearn. Provide the customer with oil change information.

**WARRANTY INFORMATION**

Warranty Claim Coding:

--	--	--	--

<b>Group:</b>	12000 - Engine
<b>Noun:</b>	892 - Cooler, EGR

**Standard Repair Times:**

Step	Description	SRT	Hours
<b>HT CORE REPLACEMENT IN CHASSIS (see Example 1 below)</b>			
	HT core replacement (not including press test) - ProStar	<a href="#">R12-8892U</a>	3.4
	HT core replacement (not including press test) - TranStar	<a href="#">Q12-8892U</a>	3.1
	HT core replacement (not including press test) - WorkStar	<a href="#">N12-8892U</a>	3.1
	HT core replacement (not including press test) - CAT CT660	<a href="#">TC12-8892U</a>	3.1
	HT core replacement (not including press test) - PayStar	<a href="#">T12-8892U</a>	3.1
	HT core replacement (not including press test) - LoneStar	<a href="#">S12-8892U</a>	3.4
<b>EGR COOLER PRESSURE TEST</b>			
	ProStar+ EGR Cooler Pressure Test (in-chassis)	<a href="#">R12-8892U-1</a>	1.3
	TranStar EGR Cooler Pressure Test (in-chassis)	<a href="#">Q12-8892U-1</a>	1.3
	WorkStar EGR Cooler Pressure Test (in-chassis)	<a href="#">N12-8892U-1</a>	1.3
	CAT CT660 EGR Cooler Pressure Test (in-chassis)	<a href="#">TC12-8892U-1</a>	1.3
<b>LT CORE R&amp;R IN CHASSIS WITH HT (see LT iKNow when LT ONLY rep'd)</b>			
	ProStar+122 LT Core Replacement in Chassis	<a href="#">R12-8892U-3</a>	1.3
	ProStar+113 LT Core Replacement in Chassis	<a href="#">R12-8892U-2</a>	1.2
	TranStar LT Core Replacement in Chassis	<a href="#">Q12-8892U-2</a>	1.6
	WorkStar LT Core Replacement in Chassis	<a href="#">N12-8892U-2</a>	1.7
	CAT CT660 LT Core Replacement in Chassis	<a href="#">TC12-8892U-2</a>	1.7
<b>MODULE ASSEMBLY REMOVAL (see Example 2 Below)</b>			
	ProStar+ Full Cooler Removal and Install	<a href="#">R12-6892U-20</a>	5.8
	TranStar Full Cooler Removal and Install	<a href="#">Q12-6892U-20</a>	5.6
	WorkStar Full Cooler Removal and Install	<a href="#">N12-6892U-20</a>	6.1
	PayStar Full Cooler Removal and Install	<a href="#">T12-6892U-20</a>	5.6
	LoneStar Full Cooler Removal and Install	<a href="#">S12-6892U-20</a>	5.8
	CAT CT660 Full Cooler Removal and Install	<a href="#">TC12-6892U</a>	6.4
<b>HT or LT MODULE SEPARATION AND ASSEMBLY</b>			
	ProStar+ Cooler Half R&R	<a href="#">R12-6892U-3</a>	0.5
	TranStar Cooler Half R&R	<a href="#">Q12-6892U-3</a>	0.5
	WorkStar Cooler Half R&R	<a href="#">N12-6892U-3</a>	0.5
	PayStar Cooler Half R&R	<a href="#">T12-6892U-3</a>	0.5
	LoneStar Cooler Half R&R	<a href="#">S12-6892U-3</a>	0.5
	CAT CT660 Cooler Half R&R	<a href="#">TC12-6892U-3</a>	0.5
<b>EGR COOLER PRESSURE TEST (add-on when full/half cooler replaced)</b>			
	ProStar+ In-Chassis Pressure test add-on	<a href="#">R12-6892U-1</a>	0.8
	TranStar In-Chassis Pressure test add-on	<a href="#">Q12-6892U-1</a>	0.8
	WorkStar In-Chassis Pressure test add-on	<a href="#">N12-6892U-1</a>	0.8
	PayStar In-Chassis Pressure test add-on	<a href="#">T12-6892U-1</a>	0.8

	LoneStar In-Chassis Pressure test add-on	<a href="#">S12-6892U-1</a>	0.8
	CAT In-Chassis Pressure test add-on	<a href="#">TC12-6892U-1</a>	0.8
<b>LT CORE R&amp;R OFF CHASSIS (add-on when HT MODULE replaced)</b>			
	ProStar+122 LT Core Replacement off Chassis	<a href="#">R12-6892U-6</a>	0.3
	ProStar+113 LT Core Replacement off Chassis	<a href="#">R12-6892U-6</a>	0.3
	TranStar LT Core Replacement off Chassis	<a href="#">Q12-6892U-6</a>	0.3
	WorkStar LT Core Replacement off Chassis	<a href="#">N12-6892U-6</a>	0.3
	CAT CT660 LT Core Replacement off Chassis	<a href="#">TC12-6892U-6</a>	0.3
<b>MISCELLANEOUS RELEVANT SRTs</b>			
	Engine Oil Replacement	<a href="#">A12-1889U</a>	0.6
	Lambda Relearn or Replacement (see SRT section of iKNow)	<a href="#">IK1201065</a>	

**EXAMPLE 1:** A ProStar+113 has the HT core replaced for leaking and the LT core for 2659-21--the warranty claim should be:

**EGR Cooler pressure test** (R12-8892U-1, 1.3hrs)

**HT Core R&R** (R12-8892U, 3.4 hrs)

**LT Core R&R** (R12-8892U-2, 1.2 hrs)

**Oil Change** (A12-1889U, 0.6 hrs)

**Lambda relearn/replacement** (depends on the condition of the Lambda)

**EXAMPLE 2:** A ProStar+113 has the HT and/or LT half replaced, due to external cracking (or no core tool)--the warranty claim should be:

**EGR Cooler pressure test add-on** (R12-6892U-1, 0.8hrs)

**EGR Cooler Removal/Installation** (R12-6892U-20, 5.8hrs)

**EGR Cooler half separation/assembly** ( , 0.5)

If applicable ONLY - **LT Core R&R** on bench of 0.3 hrs (ex, 2659-21), **Oil Change** (if HT or LT leaking INTERNALLY), and **Lambda Rep/Relearn** (if HT or LT leaking INTERNALLY).

With the warranty claim comments, we need only the basics--"Truck came in with leaking HT and plugged LT. Replaced both cores, oil, and performed lambda relearn/replacement."

[SRT Manual](#)

## **OTHER RESOURCES**

[2010 MaxxForce 11/13 Resource Center \(IK1200548\)](#)

[2010 MaxxForce 11/13 Diagnostic Manual](#)

[2010 MaxxForce 11/13 Service Manual](#)

[HT Tool Instructions \(TL2900093\)](#)

[EGR Low Flow - 2659-21 \(IK1201100\)](#)

[LT Core Removal/Install Tool Instructions \(TL2900085\)](#)

[ProStar LT Instructions \(iKNow 1201096\)](#)

[TranStar LT Instructions \(iKNow 1201097\)](#)

[WorkStar/CAT LT Instructions \(iKNow 1201098\)](#)

 Hide Details

Feedback Information

Viewed: 2471

Helpful: 21

Not Helpful: 1

No Feedback Found