

© 2014 Mazda Motor of America, Inc.

<b>Subject:</b> VARIOUS ELECTRICAL SYSTEM MALFUNCTION(S) RELATED TO C-15 CONNECTOR CORROSION	<b>Bulletin No:</b> 09-005/14
	<b>Last Issued:</b> 02/07/2014

## BULLETIN NOTE

- This bulletin supersedes the previous bulletin 09-005/14, issued on 01/14/14 and 09-031/13, issued on 11/11/13. The PART(S) INFORMATION has been revised.
- Changes are noted below in Red beside the change bar.

## APPLICABLE MODEL(S)/VINS

2013-2014 CX-5 vehicles with VINs lower than JM3KE\*\*\*\*\*365953 (produced before June 25, 2013)

## DESCRIPTION

Some vehicles may experience one or more of the following symptoms in connection with a malfunction related to the C-15 connector.

- The driver side power window does not operate.
- The door does not open when using the advanced keyless system.
- The warning lamp stays ON even after the ignition switch is turned OFF.

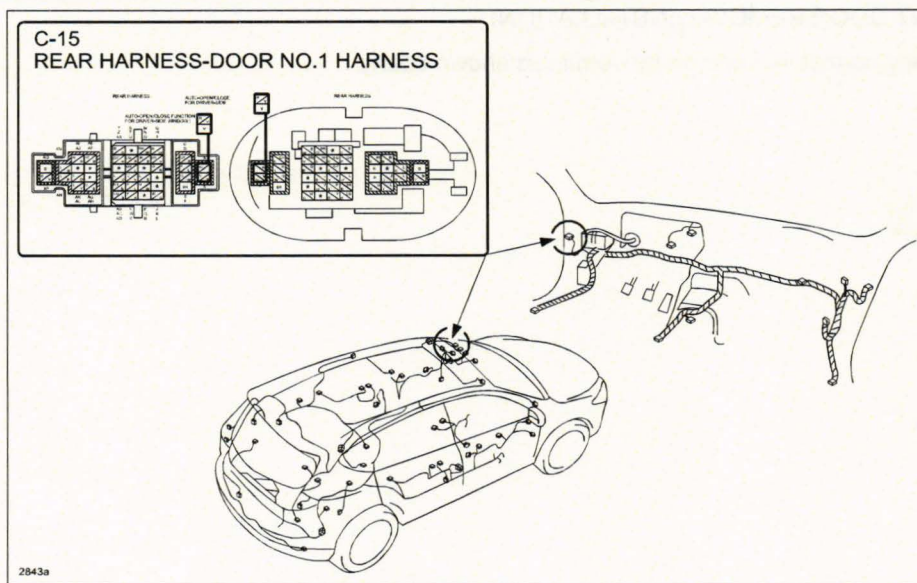

The symptoms listed above may be caused by corrosion of the C-15 connector terminals due to water intrusion through the front door. In low ambient temperatures, the door harness hardens. If the door is fully opened, it may create a gap between the door and the door harness grommet, which may allow water to enter through the gap.

**CONSUMER NOTICE:** The information and instructions in this bulletin are intended for use by skilled technicians. Mazda technicians utilize the proper tools/equipment and take training to correctly and safely maintain Mazda vehicles. These instructions should not be performed by "do-it-yourselfers." Customers should not assume this bulletin applies to their vehicle or that their vehicle will develop the described concern. To determine if the information applies, customers should contact their nearest authorized Mazda dealership. Mazda North American Operations reserves the right to alter the specifications and contents of this bulletin without obligation or advance notice. All rights reserved. No part of this bulletin may be reproduced in any form or by any means, electronic or mechanical---including photocopying and recording and the use of any kind of information storage and retrieval system ---without permission in writing.

**MASS PRODUCTION CHANGES:**

- The front door harness grommet has been changed to improve sealing performance.
- Holes inside the front pillar (which are made for weight reduction), have been covered to prevent water intrusion.

Customers with this concern should have their vehicle repaired according to the following repair information.

**REPAIR PROCEDURE**

**OUTLINE:**

If one or more of the above mentioned symptoms can be confirmed, disconnect the C-15 connector (which joins the door harness and the rear harness). Inspect for any signs of corrosion of the C-15 connector terminals referring to the inspection procedure below.

- If there is any corrosion at the C-15 connector, replace the door harness and repair the rear harness according to the following repair procedure.
  - If there is no corrosion found at the C-15 connector, this bulletin is not applicable. Troubleshoot the concern(s) according to the MS3 online instructions or the Workshop Manual.
1. Verify the customer concern.
  2. Record customers pre-set radio stations.
  3. Slide the driver side front seat fully backwards.
  4. Disconnect the negative battery cable.
  5. Disconnect the C-15 connector according to the MS3 online instructions or the Workshop Manual (section 09-11 FRONT DOOR REMOVAL/INSTALLATION).
  6. Inspect for any corrosion found on the terminals shown below.

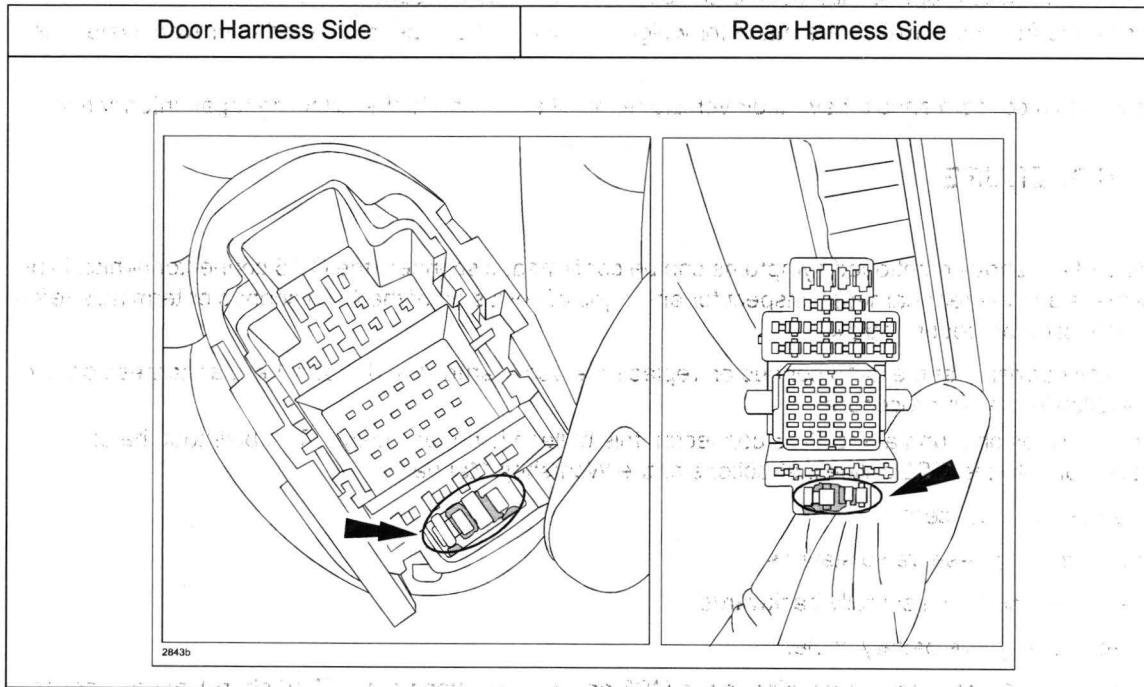

- If there is any corrosion found on the terminals, go to next step.
  - If there is no corrosion found on the terminals, this bulletin is not applicable. Troubleshoot the concern(s) according to the MS3 online instructions or the Workshop Manual.
7. Remove the driver-side front side trim according to the MS3 online instructions or the Workshop Manual (section 09-17 FRONT SIDE TRIM REMOVAL/INSTALLATION).
  8. Remove the hood release lever from the under panel according to the MS3 online instructions or the Workshop Manual (section 09-14 HOOD LATCH AND RELEASE LEVER REMOVAL/INSTALLATION).

9. Attach masking tape to the switch panel and dashboard to avoid any damage during the repair.

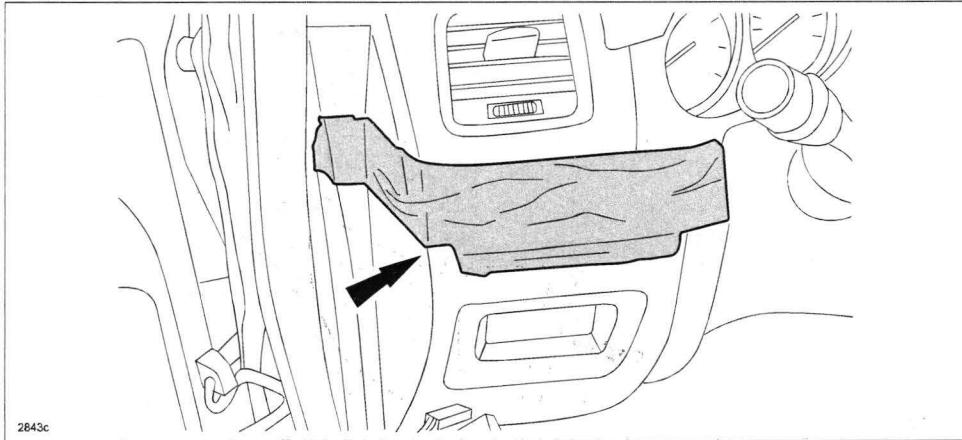

10. Remove screw (A), clips (B) and hooks (C) to loosen the lower panel (D).

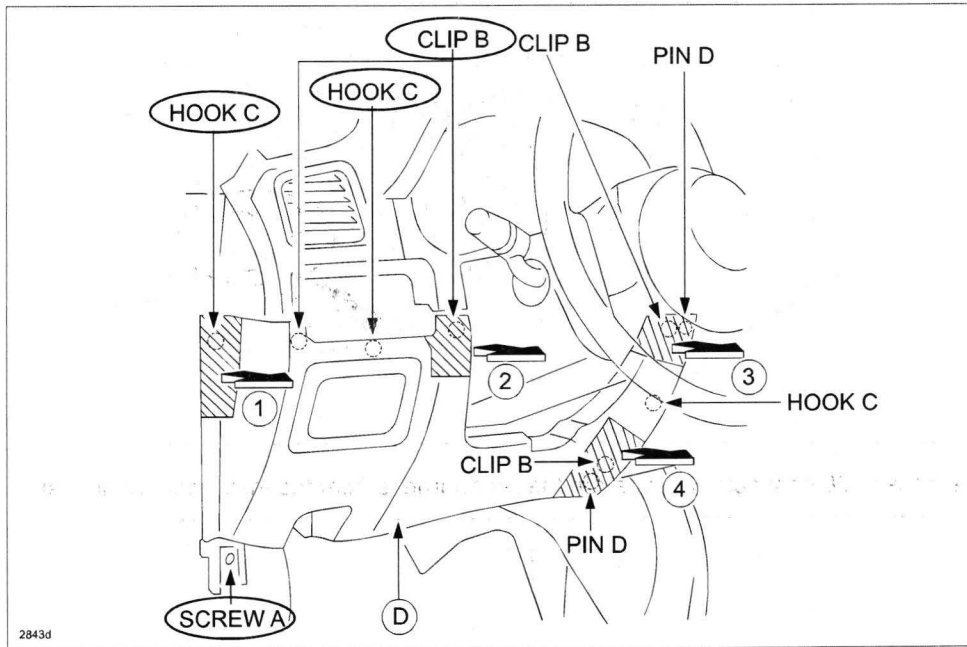

11. Move the lower panel aside.

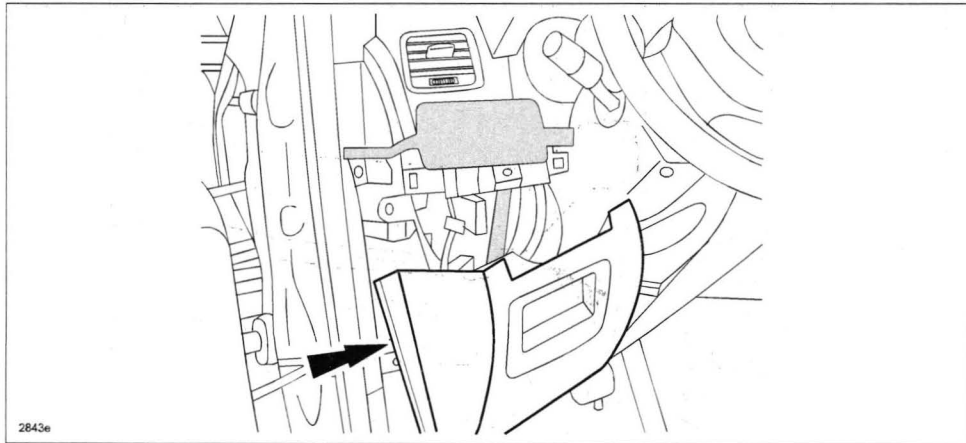

12. Remove the harness clip.

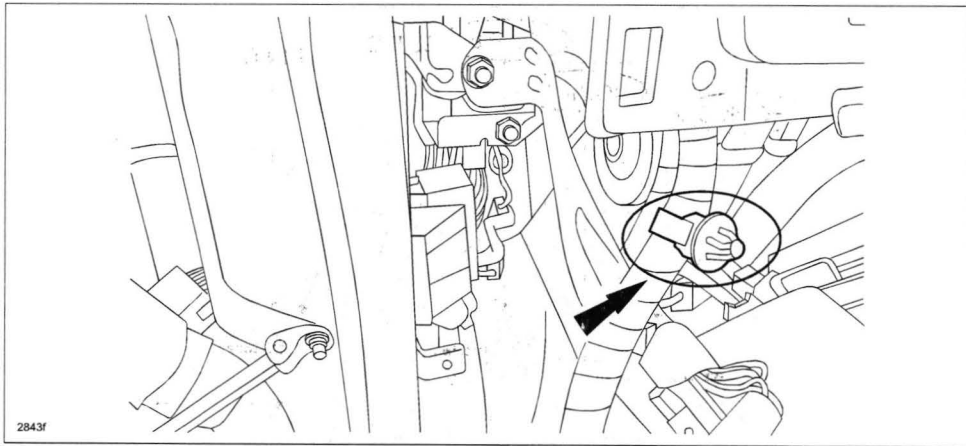

13. Disconnect the C-08 connector to separate the rear harness from the instrument panel harness.

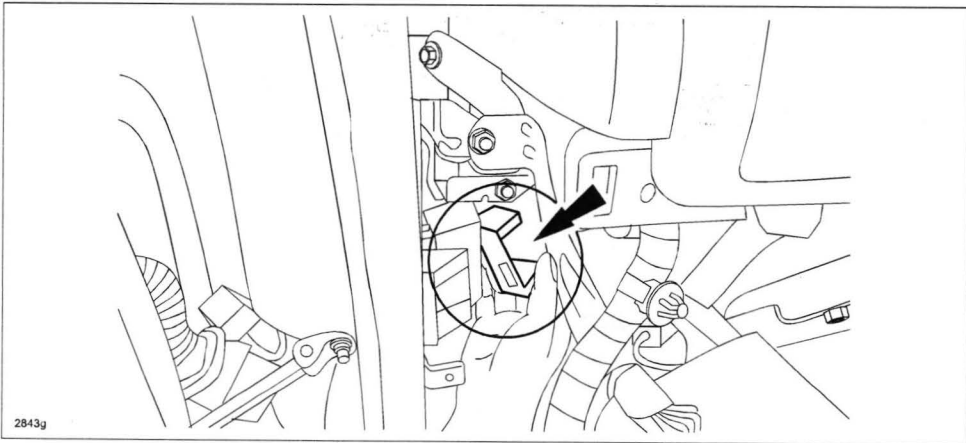

14. Using a small flathead screwdriver, push the tab of the C-08 connector bracket (A) in the direction of the arrows, then remove the C-08 connector bracket from the body.

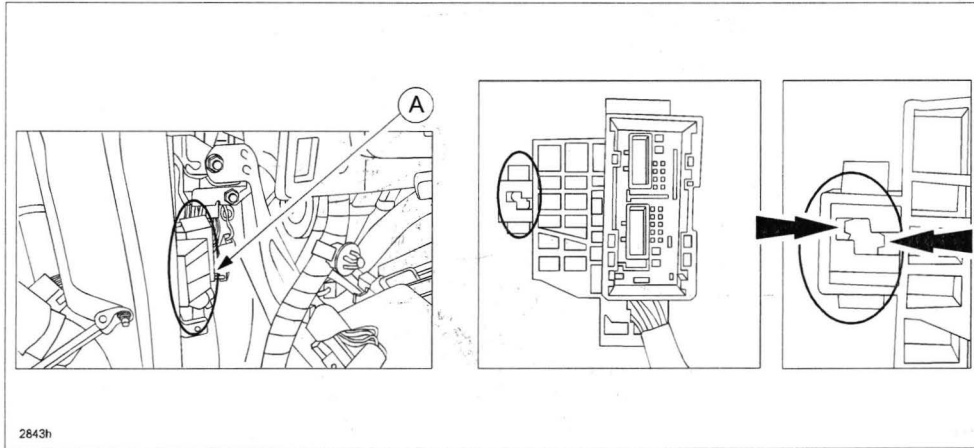

15. Install the harness clip.

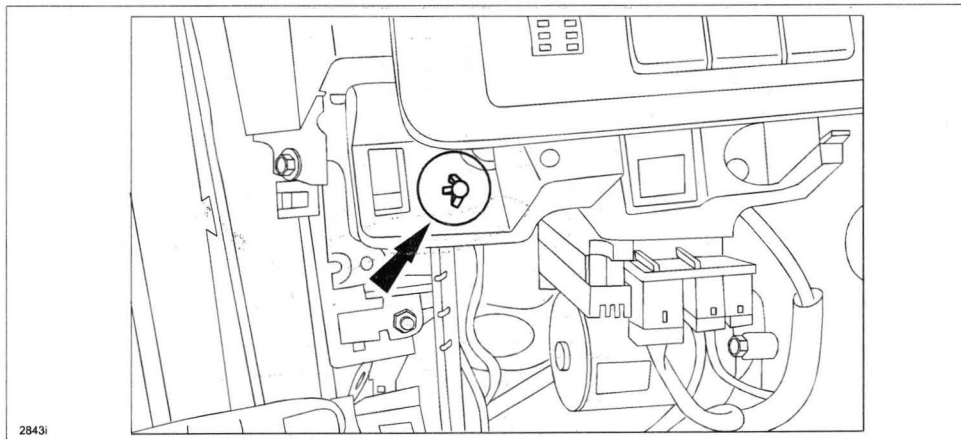

16. Place the lower panel back to the original position.

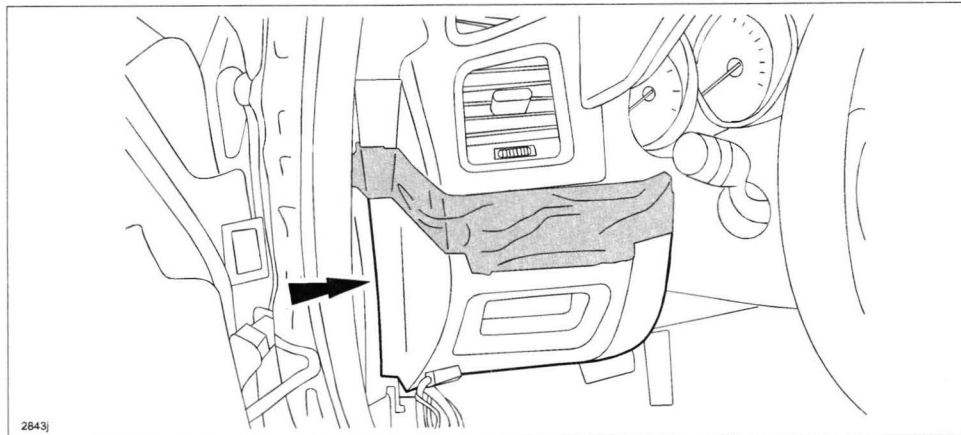

17. Pull the C-15 connector out of the front pillar inside the cabin.

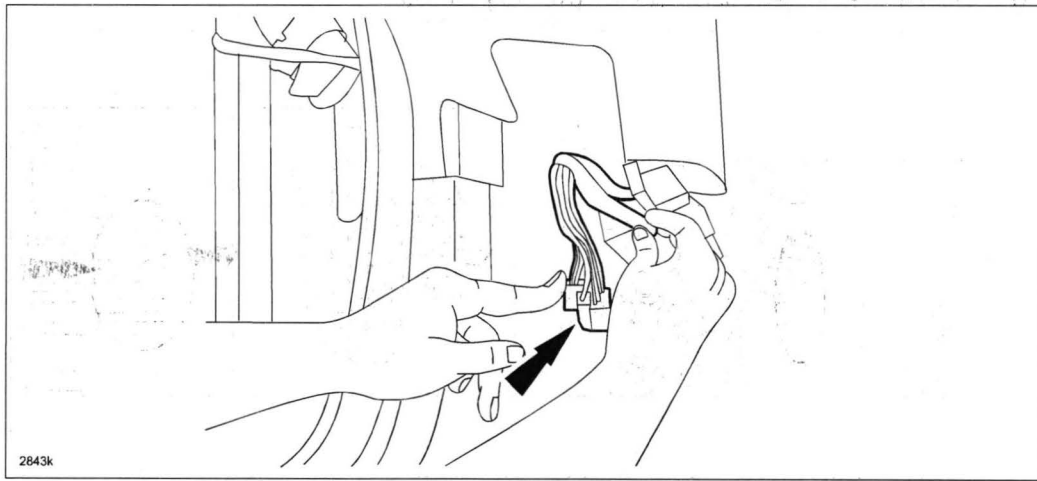

18. Remove the insulation and protector tube for the rear harness to the extent shown below:

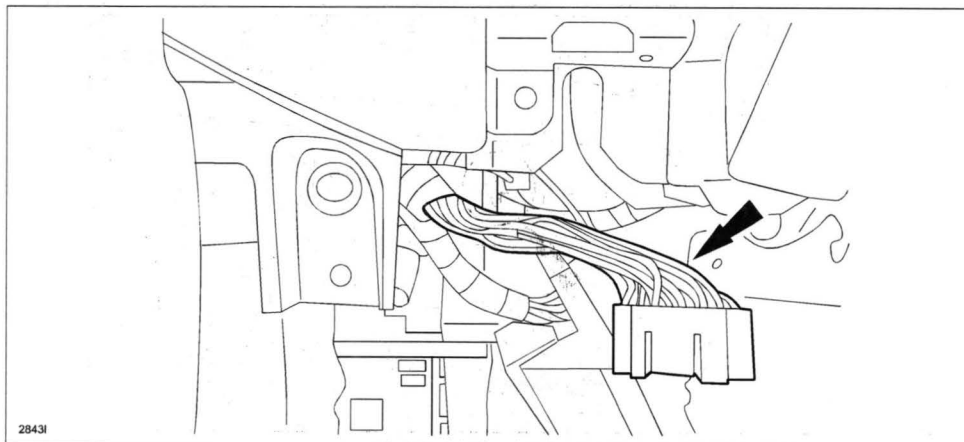

19. Remove the two (2) terminals shown below from the C-15 connector using a small flathead screwdriver.

**NOTE:** The wire colors are different depending on the vehicle specification. Refer to the appropriate Wiring Diagram.

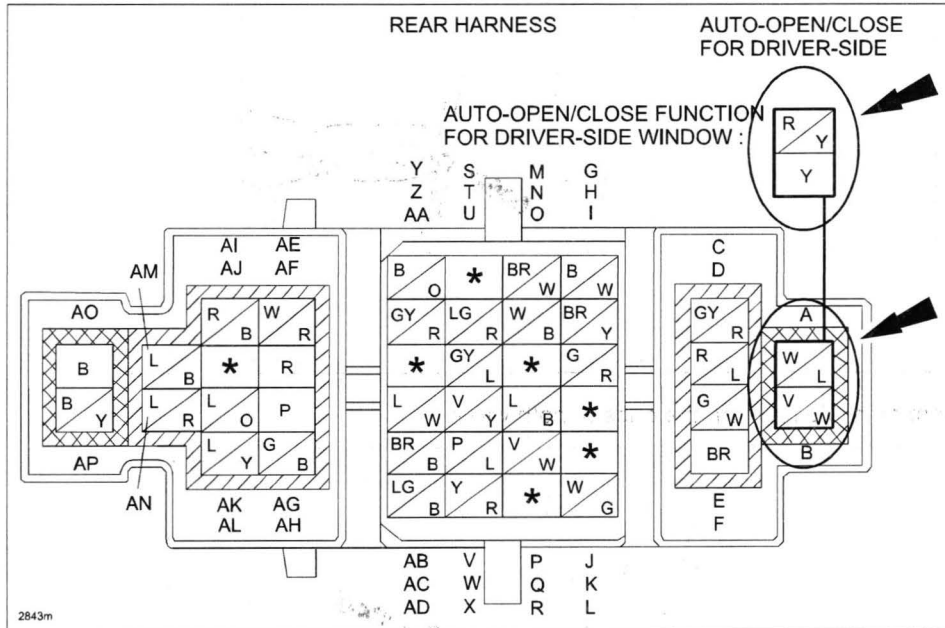

Terminal removal: screwdriver (A), terminal (B), holder (C)

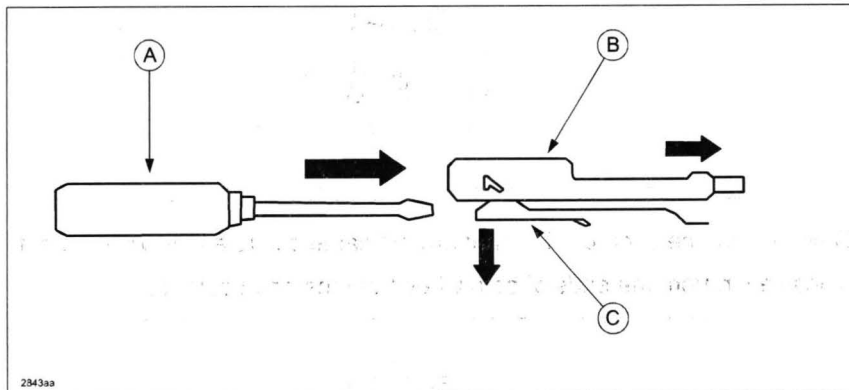



20. Cut the two (2) removed wires 10mm from the terminal.

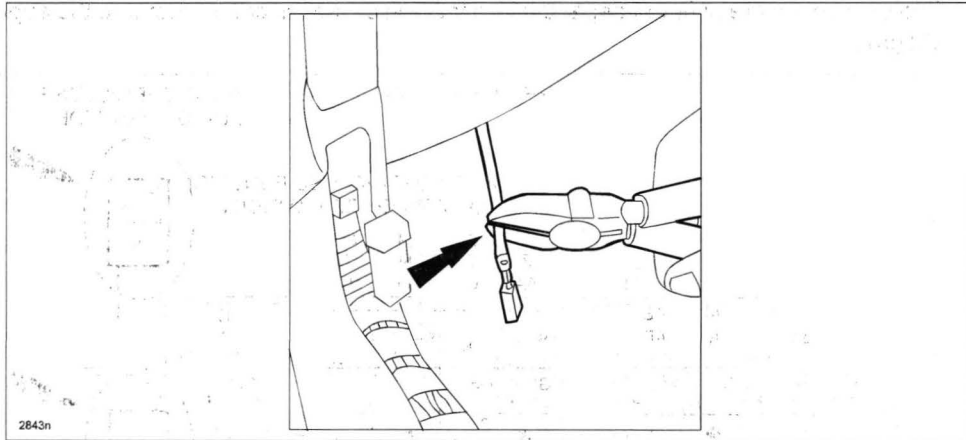

21. Strip 20mm of insulation from the ends of both wires.

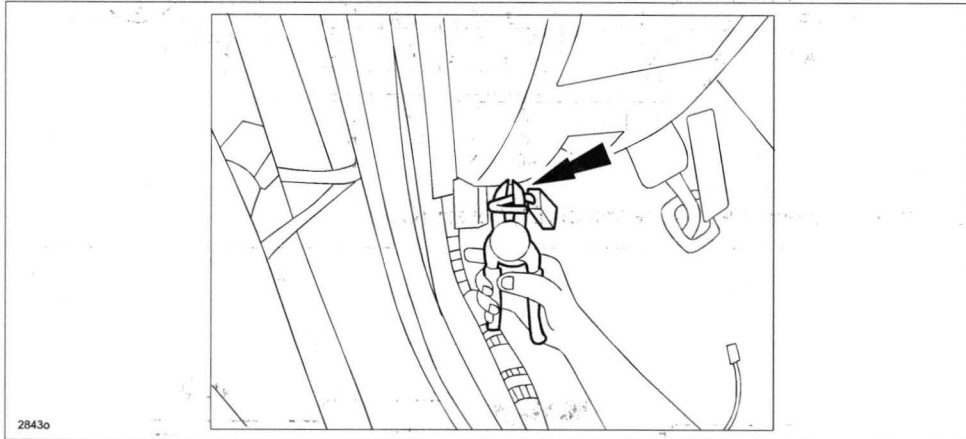

22. Select two (2) wires from the short cord kit that are the same colors as the wires from the vehicle.

23. Strip 20mm of insulation from the ends of both wires from the short cord kit.

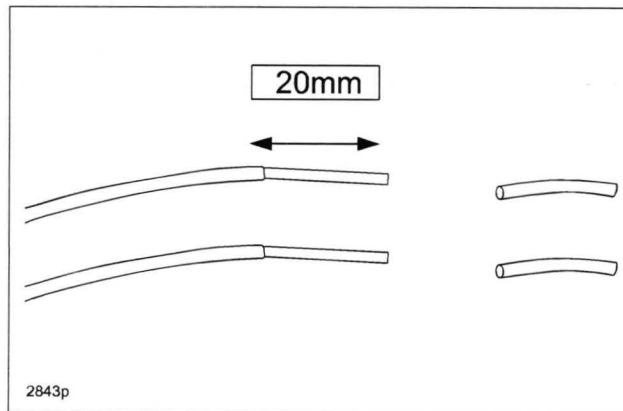

24. Pass the wires from the kit through the heat shrink tubes (A), then temporarily secure with masking tape (B).

**NOTE:** Use the larger heat shrink tube for the larger (yellow) wire and the smaller tube for smaller (red/yellow) wire.

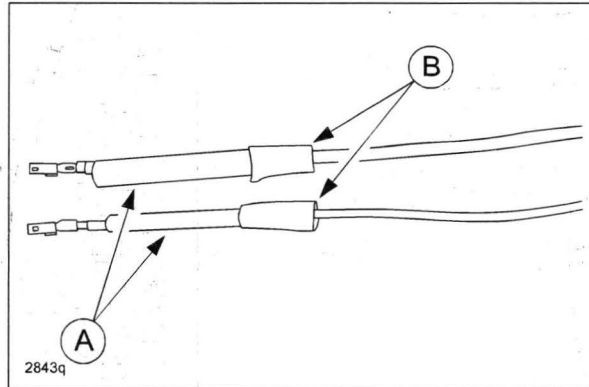

25. Connect the wires from the vehicle side and the wires from the short cord kit by twisting them together.

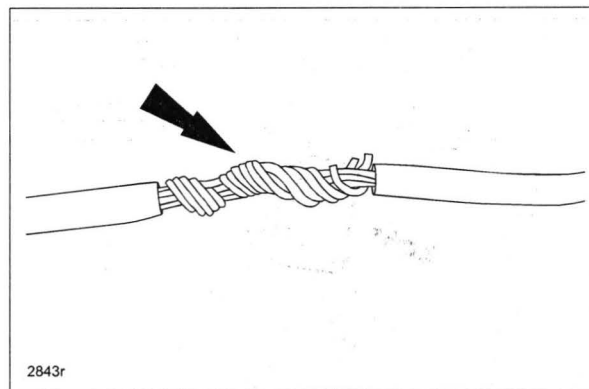

26. Solder the twisted wires together, spreading the solder out across the entire twisted wires.

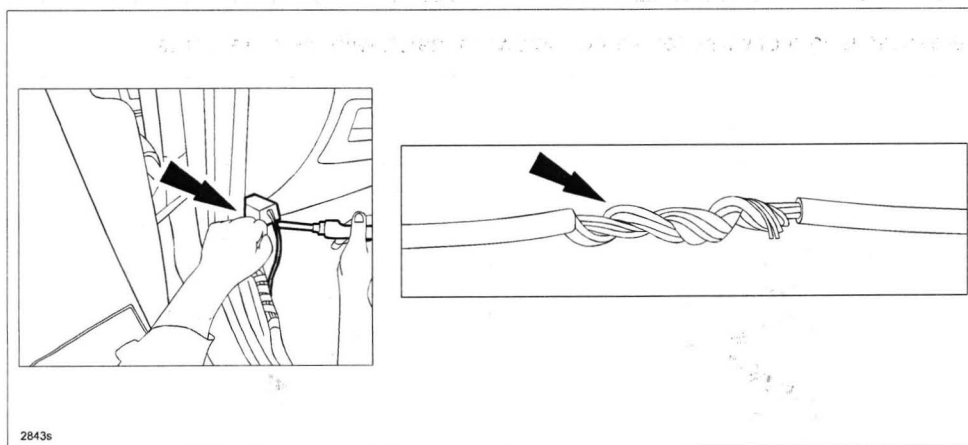

27. Place the heat shrink tube over the center of the soldered area. Using a heat gun, apply heated air until the tube shrinks securely over the soldered wires.

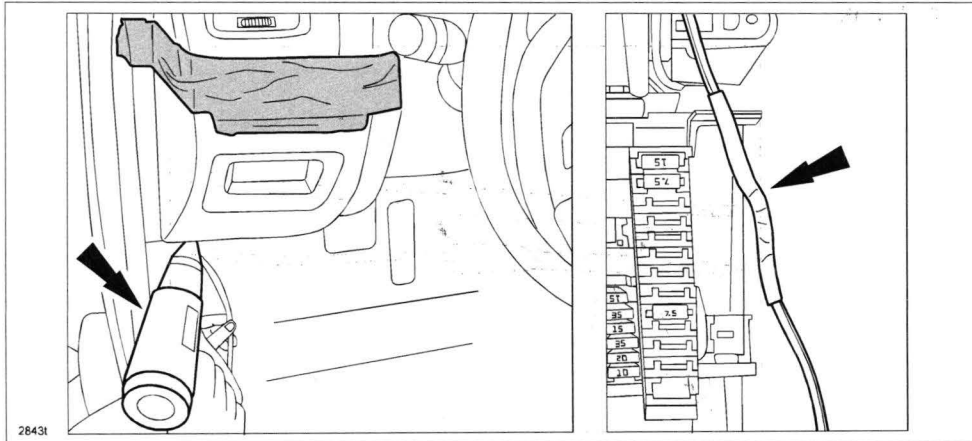

28. Install the repaired terminals into the connector.

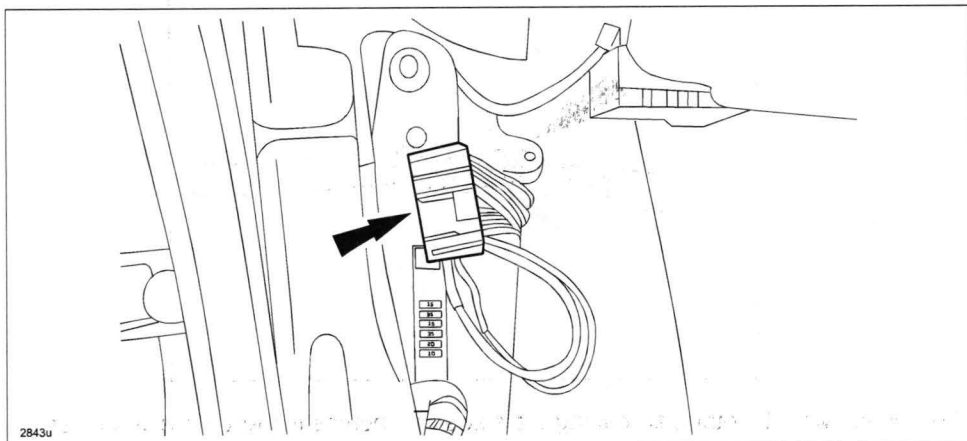

29. Bend the excess length of wires (as shown below) to match with the other wires.

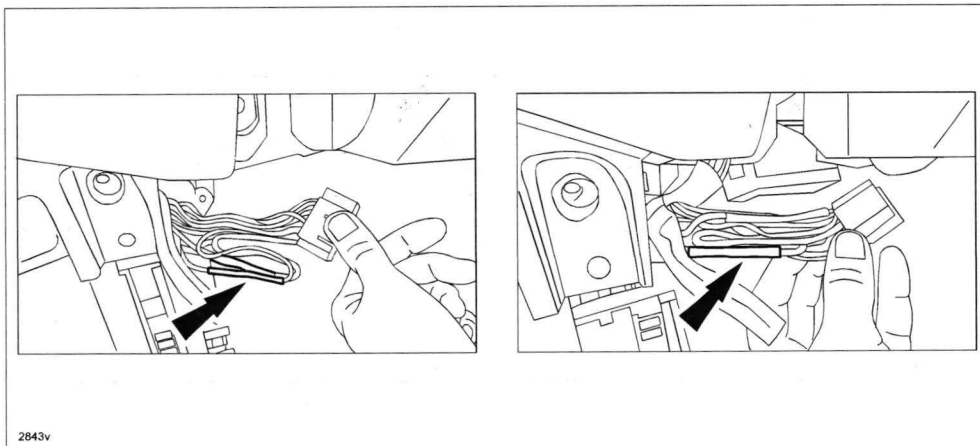

30. Wrap the harness with electrical tape as shown below.

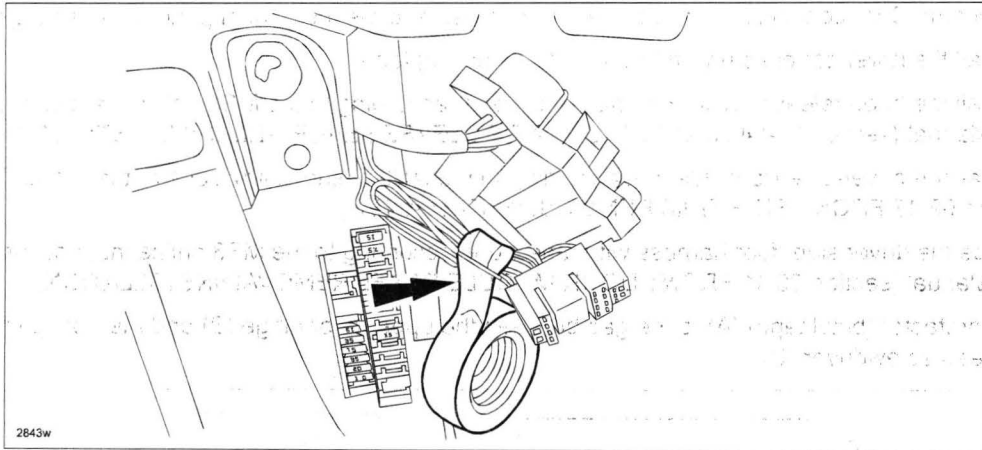

31. Install the protector tube as shown below, then secure both ends with electrical tape.

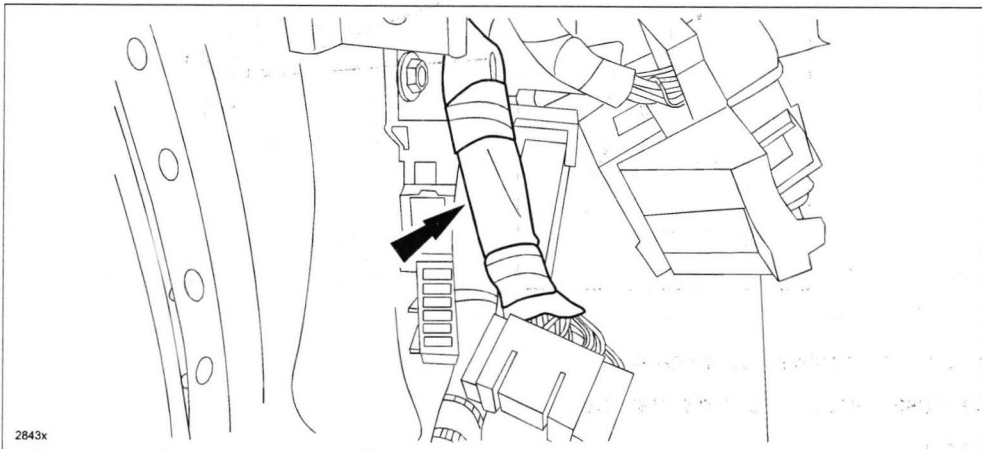

32. Pull out the C-15 connector from the front pillar to the door side.

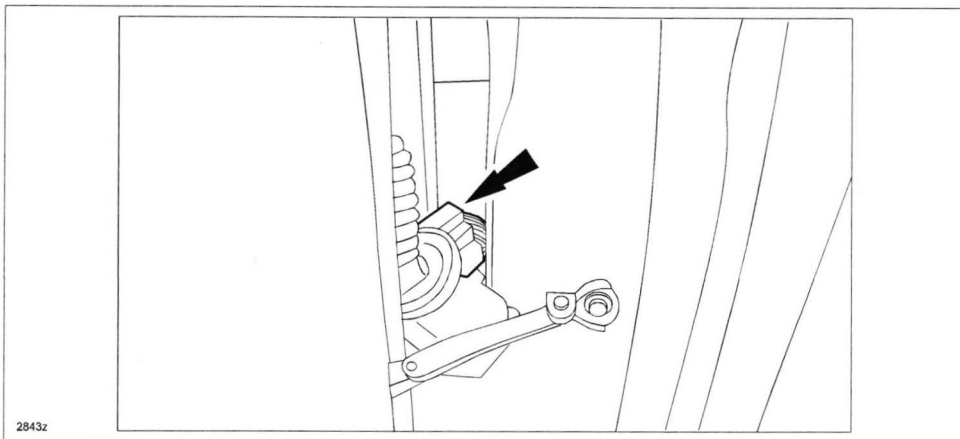

33. Install the plastic bracket for the C-08 connector to the body.
34. Connect the C-08 connector (connect the rear harness and the instrument panel harness together).
35. Reinstall the lower panel screw and remove the masking tape.
36. Reinstall the hood release lever from the under panel according to the MS3 online instructions or the Workshop Manual (section 09-14 HOOD LATCH AND RELEASE LEVER REMOVAL/INSTALLATION).
37. Reinstall the driver-side front side trim according to the MS3 online instructions or the Workshop Manual (section 09-17 FRONT SIDE TRIM REMOVAL/INSTALLATION).
38. Replace the driver side door harness with a new one according to the MS3 online instructions or the Workshop Manual (section 09-11 FRONT DOOR MODULE PANEL REMOVAL/INSTALLATION).
39. Apply protector (butyl tape) (A) to the gap between the upper door hinge (B) and the front pillar panel using a flathead screwdriver (C).

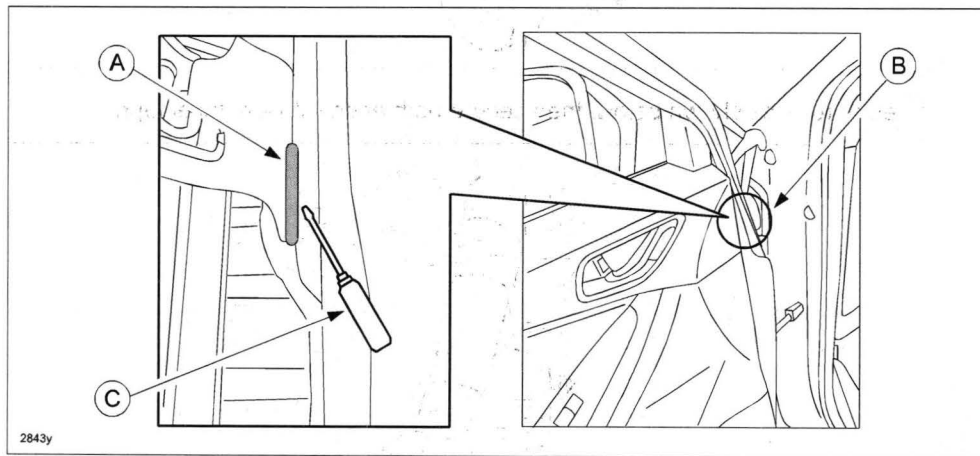

40. Re-connect the negative battery cable.
41. Re-enter customers pre-set radio stations.
42. Verify repair.

**Bulletin No:** 09-005/14  
© 2014 Mazda Motor of America, Inc.

**Last Issued:** 02/07/2014

## PART(S) INFORMATION

Part Number	Description	Qty.	Notes	Country
KDY1-67-SH0	Short Cord	1	---	All
G3YA-67-PG1	Protector	1	Butyl tape	All
KG03-67-190C	WIRING ASSY-DR,F	1	Driver side	USA / Canada
KG39-67-190B	WIRING ASSY-DR,F	1	Driver side	Mexico

## WARRANTY INFORMATION

### NOTE:

- This warranty information applies only to verified customer complaints on vehicles eligible for warranty repair.
- This repair will be covered under Mazda's New Vehicle Limited Warranty term.
- Additional diagnostic time cannot be claimed for this repair.

Warranty Type	A
Symptom Code	41
Damage Code	93
Part Number Main Cause	(SEE PART(S) INFORMATION)
Quantity	1
Operation Number / Labor Hours:	XXJCXXRX / 0.8 Hrs: