



© 2014 Mazda Motor of America, Inc.

| | |
|--|--------------------------------|
| Subject: i-ELOOP BATTERY SERVICE INFORMATION | Bulletin No: 01-002/14 |
| | Last Issued: 02/25/2014 |

BULLETIN NOTE

- This bulletin supersedes the previous bulletin 01-002/14, issued on 02/07/2014, 01-016/13, issued on 09/25/2013 and 06/19/13. The Q85/T110 BATTERY ORDERING information has been added.
- Changes are noted below in Red beside the change bar.

APPLICABLE MODEL(S)/VINS

2014-2015 Mazda6 vehicles equipped with i-ELOOP

2014 Mazda3 vehicles equipped with i-ELOOP

DESCRIPTION

This service information provides basic Q-85/T-110 battery handling procedures. Complete service information can be found in MS3 online or Workshop Manual (section 01-17).

Q85/T110 BATTERY MAINTENANCE

1. Maintain battery charge during vehicle storage.
 - Charge the battery regularly even though there's no electrical load applied.
 - If battery is left discharged for long periods, battery failure may occur.
2. Maintain battery charge during parts inventory.
 - Charge the battery regularly during parts stock.
 - If battery is left discharged for long periods, battery failure may occur.

Q85/T110 BATTERY TEST AND BATTERY CHARGING

NOTE: The GR8 Battery Management System software version 195E or later is required. If version is lower than 195E, refer to GR8 BATTERY MANAGEMENT SYSTEM UPDATE before proceeding.

1. Remove the battery from the vehicle.

CAUTION: Do not charge the battery in the vehicle. Vehicle electrical system damage may occur.

2. Remove the battery filler caps.
3. Adjust battery fluid level if needed using distilled water.
4. Connect the GR8 Battery Management System using the large cables.

5. From the MAIN MENU, select Battery Test or Diagnostic.

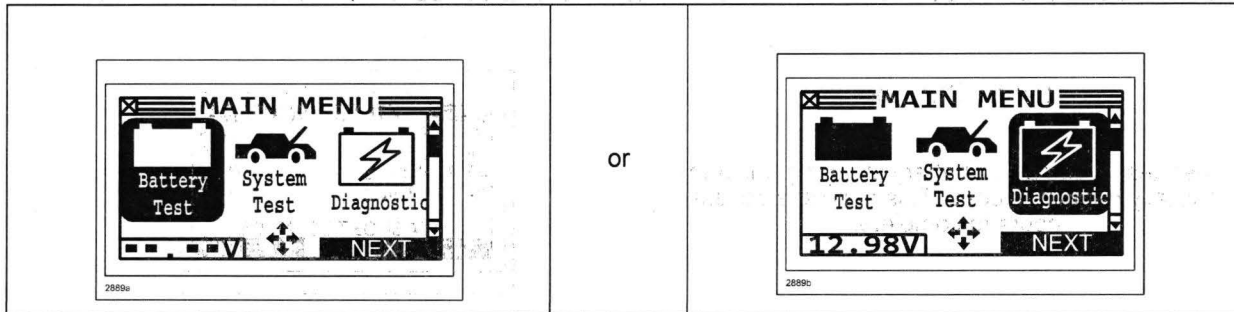

6. From the LOCATION screen, select OUT OF VEHICLE.

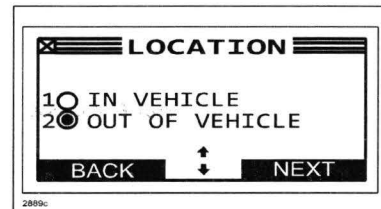

7. From the BATTERY TYPE screen, select I-ELOOP.

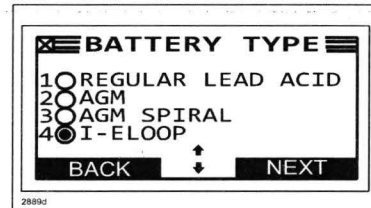

8. From the TEST USING screen, select Q-85.

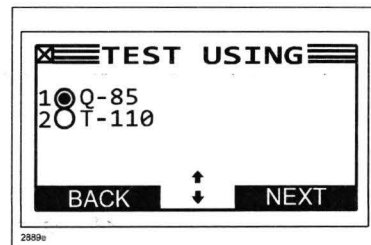

9. GR8 battery test is in process. This may take several minutes to complete.

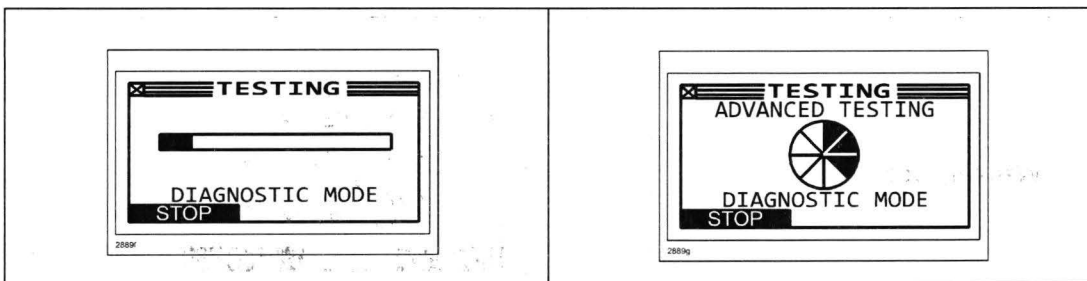

Battery Test Results

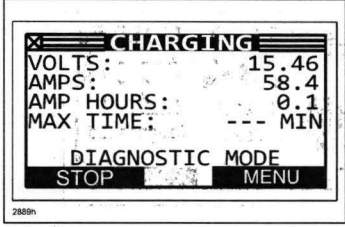
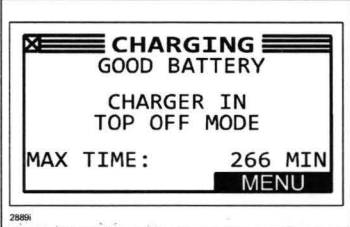
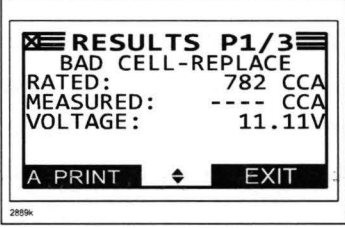
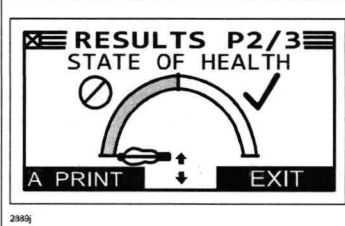
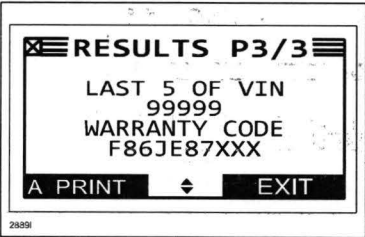
| | |
|--|---|
| <p>Battery Charging</p> <p>When test is complete, battery charging will automatically begin if needed. This may take several hours to complete.</p> |  <p>2889h</p> |
| <p>Battery Good</p> |  <p>2889h</p> |
| <p>Bad Cell</p> |  <p>2889h</p> |
| <p>State of Health</p> |  <p>2889h</p> |
| <p>Warranty Code</p> |  <p>2889h</p> |

GR8 BATTERY MANAGEMENT SYSTEM UPDATE

NOTE:

- You will need the IDS Laptop, MS3 access and the entire GR8 workstation, including the USB cable that is included with the Midtronics GR-8, in order to complete the update.
- If the cable is missing, please purchase one from your local electronics store. Cable needs to be a regular USB jack on one end and a mini-USB jack on the other end. Do not install the cable until prompted to do so.

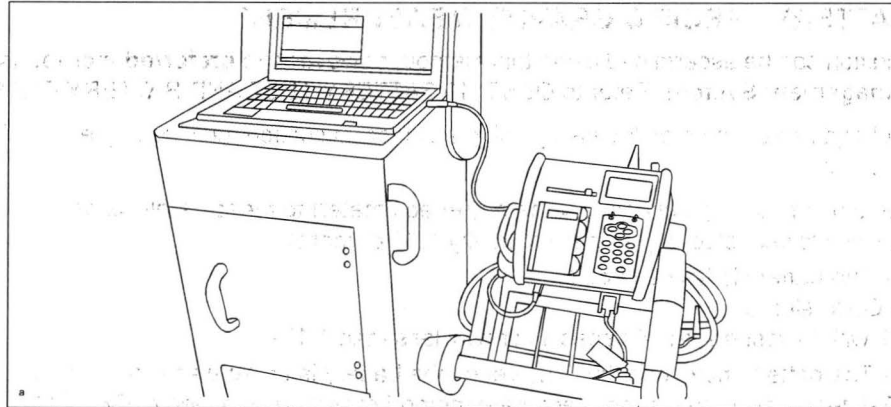

1. Plug your GR8 Workstation into a wall outlet.
2. Confirm the 6 AA batteries in the hand held unit are new.
3. Reinstall the hand held unit in its holder.
4. With the IDS Laptop, log onto MS3, then select "Special Service Tools & Current MRT List".
5. **Click Here** or select the "GR-8 Update" link below the GR-8 I-ELOOP Software Update title.
6. Select "Run" to download the Mazda(GR8-195E) file.
7. Select "Run" to install the Midtronics Update Wizard (MUW).
8. Follow the steps in the Midtronics Update Wizard to complete the 10-20 minute download.

BILLING INFORMATION

Tool(s) will be automatically invoiced to your dealer parts account statement. If your accounting department has any questions regarding this invoicing, please call Mazda Special Service Tools (949-442-6539).

| Part Number | Description | Price |
|-------------|----------------------|------------------|
| MAZ-GR8-VE | GR-8 Software Update | \$80.00 Per Unit |

Q85/T110 BATTERY VOLTAGE MEASUREMENT

Battery voltage can only be measured on a battery that has not been recently charged. If the battery was recently charged, wait 6 hours or more before checking the battery voltage.

1. Is the battery voltage 12.4 volts or higher?
 - Yes - The battery is charged.
 - No - The battery requires charging. Proceed to Q85/T110 BATTERY TEST AND BATTERY CHARGING.

Q85/T110 BATTERY SPECIFIC GRAVITY MEASUREMENT

Battery condition can be ascertained using this method; however, **the preferred method is to use the GR8 Battery Management System**. Refer to Q85/T110 BATTERY TEST AND BATTERY CHARGING.

1. Mix the electrolyte solution on all 6 cells by using a siphon to suction the electrolyte from the battery and then put it back in.
2. Use a scope type specific gravity battery meter (refractometer) to measure all six cells.
 - a. Is the cell with lowest electrolyte specific gravity 1.25 or more?
 - Yes - The battery is fully charged.
 - No - Go to step b.
 - b. Is the cell with lowest electrolyte specific gravity less than 1.17?
 - Yes - The battery may be faulty. If however, the battery is under warranty, you must use the Midtronics GR-8 tester as it uses a more accurate method of testing. Proceed to Q85/Q110 BATTERY TEST AND BATTERY CHARGING to accurately test the battery. If the Midtronics GR-8 tester fails the battery it will generate a battery failure code for warranty claim submission.
 - No - The battery requires charging. Proceed to Q85/T110 BATTERY TEST AND BATTERY CHARGING.

Q85/T110 BATTERY INSPECTION WITHOUT GR-8

If the GR8 Battery Management System is not available to test a Q85/T110 battery, refer to MS3 online or Workshop Manual section 01-17:

- Mazda3 - BATTERY INSPECTION [SKYACTIV-G 2.0, SKYACTIV-G 2.5]
- Mazda6 - BATTERY INSPECTION [SKYACTIV-G 2.5]

Q85/T110 BATTERY CHARGING WITHOUT GR-8

If the GR8 Battery Management System is not available to charge a Q85/T110 battery, refer to MS3 online or Workshop Manual section 01-17:

- Mazda3 - BATTERY RECHARGING [SKYACTIV-G 2.0, SKYACTIV-G 2.5]
- Mazda6 - BATTERY RECHARGING [SKYACTIV-G 2.5]

Q85/T110 BATTERY JUMP START

If a jump start is necessary, do not remove the jumper cables or drive the vehicle until the instrument cluster Multi-Information Display (Mazda6) or touchscreen (Mazda3) warning message "i-ELOOP charging" is no longer displayed. This process takes about 3 minutes to complete.

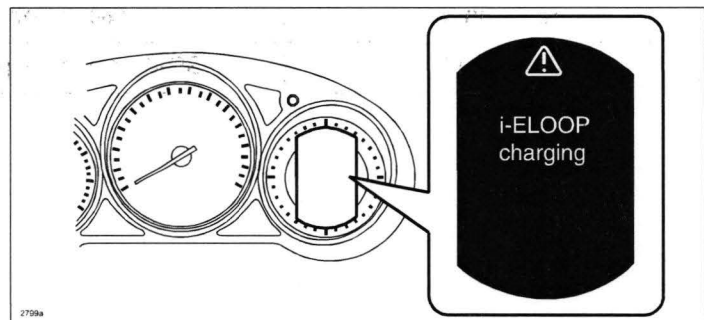

Q85/T110 NEGATIVE BATTERY CABLE DISCONNECT

1. Record audio memory.
2. Switch the ignition off.
3. Disconnect the current sensor connector (A) from the current sensor (B).
4. Disconnect the negative battery cable terminal (C).

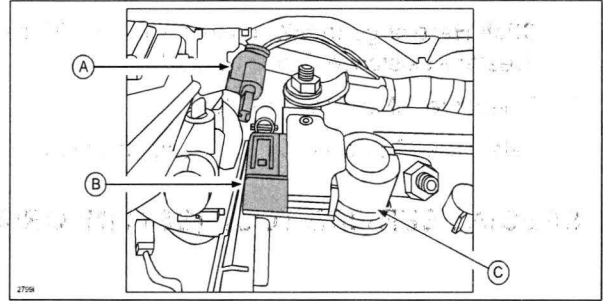

Q85/T110 NEGATIVE BATTERY CABLE CONNECTION

1. Connect the negative battery cable terminal (C).
2. Connect the current sensor connector (A) to the current sensor (B).
3. Switch the ignition ON.
4. Perform the power window system initial setting.
5. Perform the sunroof system initial setting (if equipped).
6. Set the clock.
7. Set audio memory.
8. Perform the tire pressure monitoring system (TPMS) initialization.

Q85/T110 OPERATION REQUIRED AFTER BATTERY REPLACEMENT

When replacing the battery, perform the following procedure. When replacing the PCM simultaneously, perform the PCM configuration first.

1. Switch the ignition ON (engine off).
2. Shift the selector lever to the N position.
3. Perform the following work with the brake pedal depressed.
 - a. Depress the accelerator pedal for 5 s or more.
 - b. Verify that the charging system warning light and the master warning light flash.
 - c. Depress and release the accelerator pedal 3 times.
 - d. Verify that the charging system warning light illuminates and the master warning light turns off.
4. Switch the ignition OFF and disconnect the negative battery cable. Refer to Q85/T110 NEGATIVE BATTERY CABLE DISCONNECT.
5. Connect the negative battery cable. Refer to Q85/T110 NEGATIVE BATTERY CABLE CONNECTION.

Q85/T110 BATTERY ORDERING

E-Mail the Dealer Assistance Group (DAG) on MX Connect.

1. [Click Here](#) or go to MXConnect, click the "Parts and Accessories" Tab, and in the "Support" box select the "Dealer Assistance Group (DAG)" link.
2. Select the "eMail Inquiries" tab.
3. Select the "Corporate Dealer Assistance Group, Parts Expediting/ETA Assistance" link.

SPECIAL SERVICE TOOL (SST) INFORMATION

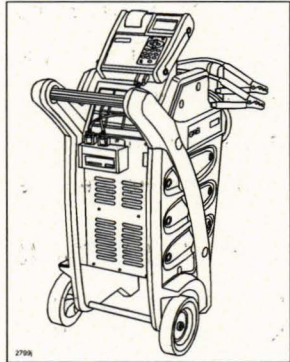
| Part Number | Description | Qty. | Image |
|--------------|--------------------------------|------|--|
| MTRGR81291KT | GR-8 Battery Management System | 1 |  |