

Technical BULLETIN

©2014 YAMAHA MOTOR CORPORATION, U.S.A.



SAFETY RECALL

This modification has top priority. This bulletin must be performed immediately to ensure customer safety.

NOTE: Bulletins that announce a recall will have an "R" at the end of the bulletin number.

ALL 2015 FZ-07 MODELS

FACTORY MODIFICATION CAMPAIGN – Positive Battery Cable

i

INTRODUCTION

Yamaha Motor Corporation, U.S.A. has decided that a defect which relates to motor vehicle safety exists in all 2015 FZ07F and FZ07FC ("FZ-07") model motorcycles. In affected motorcycles, there is a possibility for the positive (red) battery cable to be pinched between the seat base and seat bracket due to inappropriate length of the battery cable and the shape of the seat bracket. If this happens, the positive battery cable's insulation may be chafed away over time, resulting in sparks, increasing the risk of fire.

To correct this problem, Yamaha is initiating a Factory Modification Campaign. Affected units must have the positive battery cable and seat bracket replaced with new ones of a different design and a revision sticker added to the Owner's Manual to show the new positive battery cable routing.

Yamaha is notifying all registered owners of affected motorcycles by mail. A copy of this letter is included in this bulletin. The customer should take this letter along with the affected motorcycle to an authorized Yamaha dealer for modification.

A computer report listing all affected motorcycles invoiced to your dealership is included with this bulletin. Use the list to help ensure all motorcycles are modified. All sold motorcycles that have been registered with Yamaha will show the customer's name and address. Your dealership must notify the owner of any affected motorcycle that was actually sold but listed as "unsold" in the report.

You must modify all affected motorcycles in your inventory as well as all customer-owned motorcycles brought to you for this service. Any affected motorcycle that you purchase from Yamaha in the future may also require modification. If you purchase a motorcycle from another dealer or Yamaha, check to see if the procedures in this bulletin have already been performed before you sell the motorcycle.

Motorcycles that are affected should not be operated until they are modified. It is a violation of Yamaha policy for your dealership to deliver any affected motorcycle to customers until the procedures in this bulletin are performed.

When the modification on each motorcycle is performed, follow the Warranty information section of this bulletin to receive reimbursement. Be sure to use the Factory Modification Campaign procedures in Chapter 7 of the **Warranty and Y.E.S. Handbook** (LIT-11760-00-08).





DEALER ACTION SUMMARY

Unsold

Units: Follow the procedures listed in this bulletin to modify all units within the affected range, as well as insert the revision sticker in the Owner's Manual for each unit as instructed.

Sold

Units: Check first to be sure the modification has not already been performed (see Identification Procedure in this bulletin for more information). Install the new positive battery cable and the new seat bracket, and also insert the revision sticker in the Owner's Manual as instructed in this bulletin.

Parts: Yes, order a battery positive lead (cable) kit for each affected unit. Refer to the Parts Information below.

Warranty: Factory Modification Campaign. See the Warranty Information section of this bulletin. This modification applies to all affected units regardless of ownership or warranty status.

Notify

Customers: Yes, you must immediately contact any customer whose motorcycle shows as unregistered on the enclosed report. Yamaha has sent letters to customers whose motorcycles were registered with Yamaha as of 10/30/2014.



AFFECTED RANGE

2015 FZ07F

RM06E - 000002 ~ 0002606

2015 FZ07FC

RM06Y - 000008 ~ 0000734



SERVICE PROCEDURES

1. Remove the 2 bolts that attach the seat below the rear corners. Remove the seat and set it aside.



2. Remove the 4 seat bracket bolts and remove the seat bracket. The bolts will be reused.

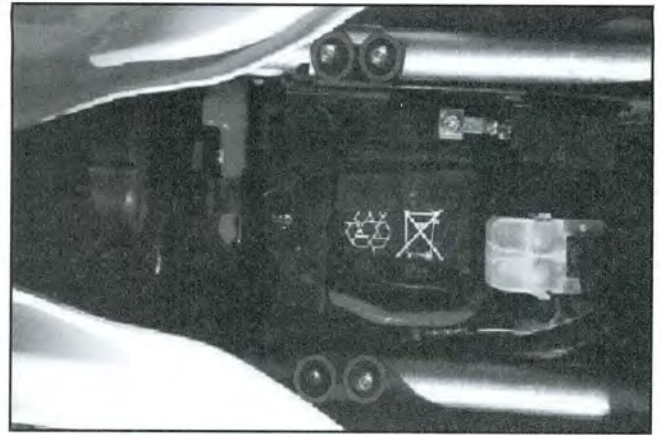

3. Disconnect the negative battery cable from the battery, and then disconnect positive battery cable.



4. Remove the battery retaining strap from the battery tray, and set it aside for reuse. Remove the cover from the starter relay.

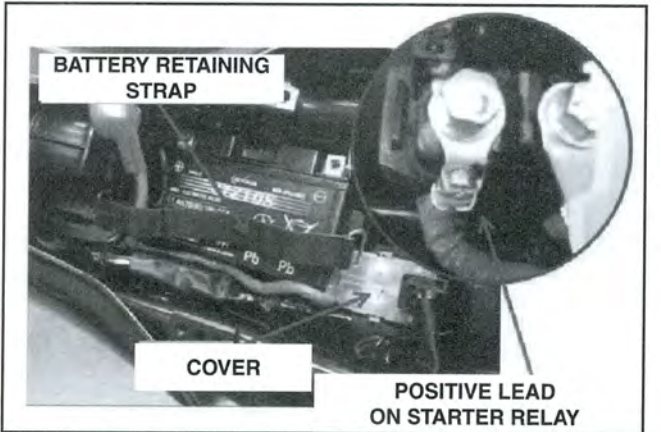

5. Disconnect the positive battery cable from the starter relay and remove the cable from the motorcycle. The mounting bolt will be reused.

6. Install the new battery cable in the original battery retaining strap as shown.

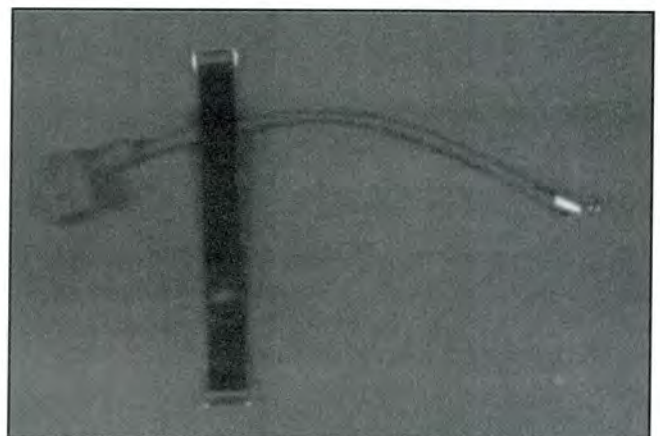

7. Connect the battery positive cable to the starter relay as shown.

Tightening Torque: 2.2 Nm (0.22 m-kgf, 1.6 ft-lbf, 19.5 in-lbf)

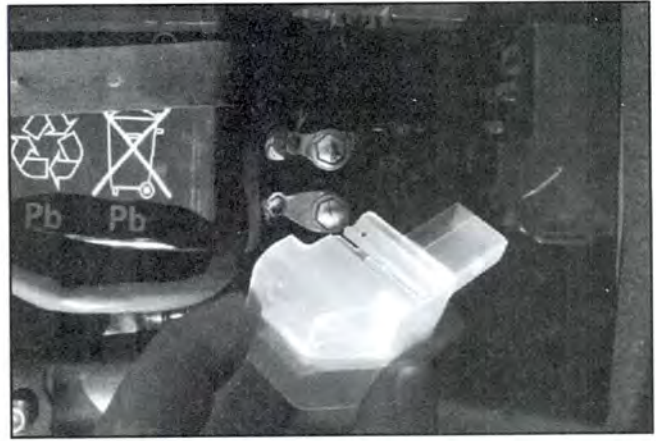

NOTICE:

The battery cable terminal must be oriented as shown.

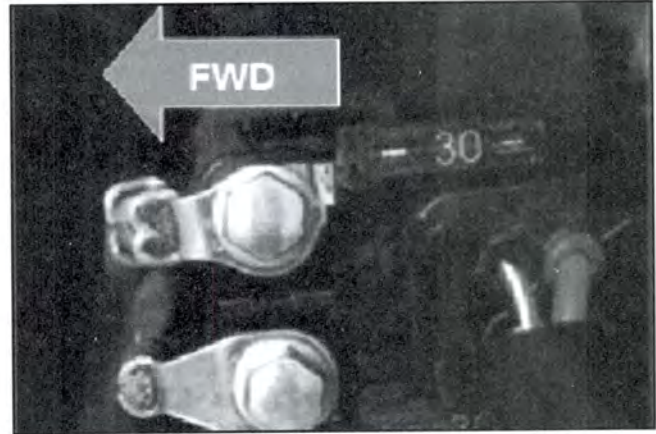

8. Route the wiring as shown in the adjacent figure.

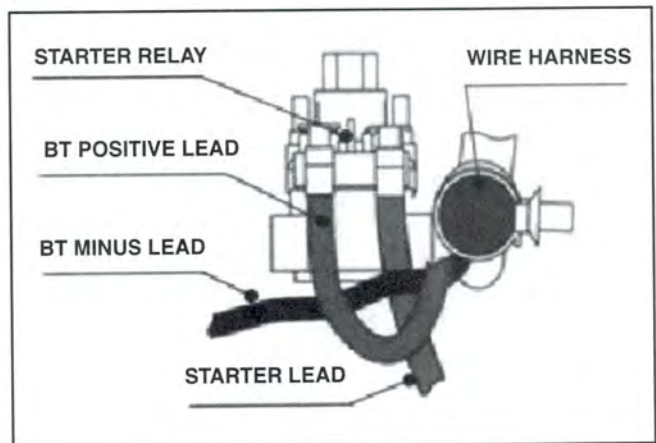

9. Route the battery positive cable as shown in the adjacent figure. Reinstall the starter relay cover removed in step 4.



10. Connect the positive battery cable to the positive terminal of the battery and then the negative cable to the negative terminal. Reinstall the battery retaining strap.

Tightening Torque: 2.2 Nm (0.22 m-kgf, 1.6 ft-lbf, 19.5 in-lbf)

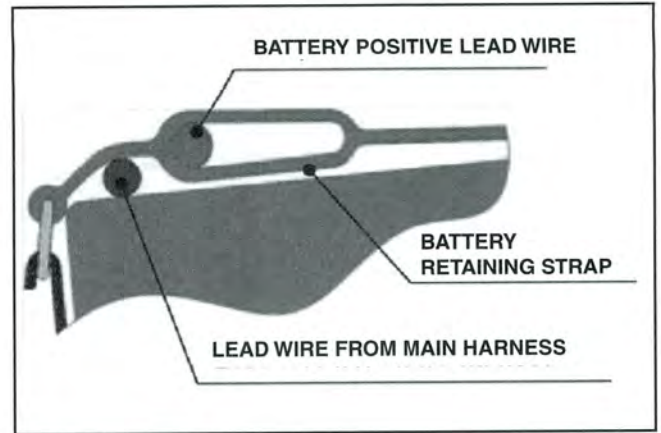

11. Install the clamp (cable tie) under the battery positive cable and the main wire harness.

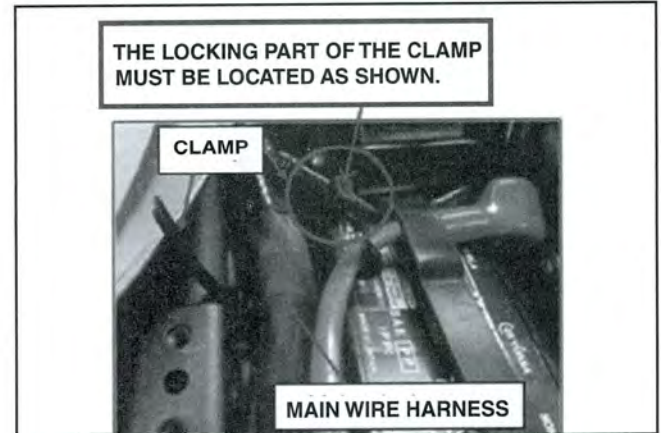

12. Fasten the battery positive cable and the main wiring harness with the clamp 5mm forward of the vinyl tape on the main wiring harness.

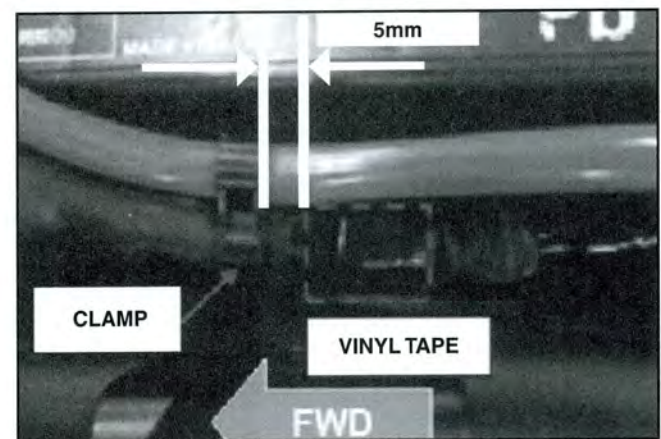

13. Trim excess clamp (cable tie). The cutting position must be below the red line in the adjacent photo.

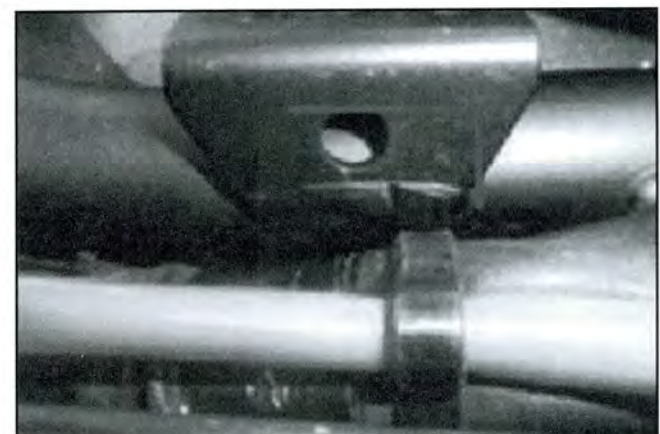

14. Install the new seat bracket from the kit using the original hardware.

Tightening torque: 7 Nm (0.7m-kgf, 5.1 ft-lbf)

15. Reinstall the seat using the original hardware.

Tightening torque: 7 Nm (0.7m-kgf, 5.1 ft-lbf)

16. Affix the revision sticker on page 7-30 of the Owner's Manual (LIT-11626-28-07) as shown.

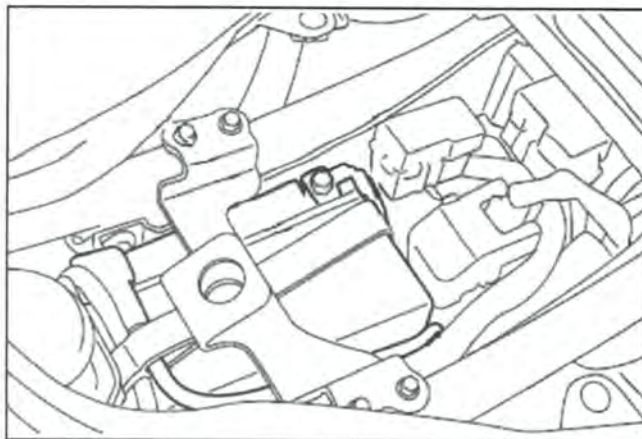

AFFIX THE STICKER ON THE BATTERY WIRE ROUTING FIGURE

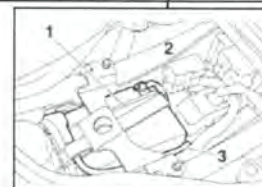

IDENTIFICATION PROCEDURE

After modifying a unit, make sure to properly record and submit the warranty claim for this safety recall to update the unit's repair history in the Yamaha database. If you encounter an unfamiliar unit, check the Unit Status in YDS. A modified unit can also be identified by the shape of the seat bracket as shown below.

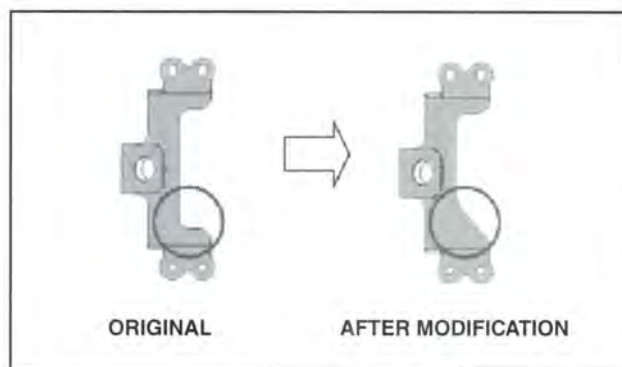

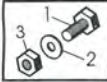

PARTS INFORMATION

Part Number	Description	Model	Qty.	Dealer Cost
90891-30098-00	Battery Positive Lead Kit	FZ-07	1	\$15.78

Kit Parts Contents

No.	Part Name	Qty.
1	Wire, Positive Lead (Cable)	1
2	Seat Fitting Bracket	1
3	Clamp (Cable Tie)	1
4	Sticker (Owner's Manual)	1

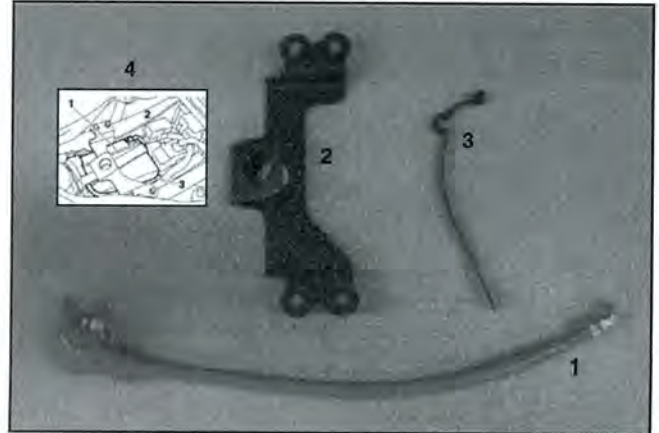

WARRANTY INFORMATION

The owner of each registered unit will receive a letter announcing this campaign. The customer's letter includes the Primary ID and Recall Number.

The modification is authorized for all affected motorcycles, both sold and unsold, regardless of ownership or warranty status. You do not need the customer's letter to perform the modification or to file for reimbursement.

Submit a Recall Request for the parts* and labor as described below using Recall Number **990089**. The labor allowance is **0.3** hour.

YDS:

When signed on to YDS, click on the Service Tab, and then "Recall Request-Add." This function will allow you to enter multiple Primary IDs for the same recall. Remember, YDS requires a 7-digit serial number, so use a "0" as the first digit. The system will check your submission instantly to make sure the Primary ID numbers you've entered are valid for the recall. You can check back the next day for your claim numbers to track your credit.

MAIL:

Complete a Recall Reimbursement Request (LIT-11790-00-03) as shown below:

Dealer Number	<input type="text"/>	Dealer Name	<input type="text"/>
Recal Number	Primary I.D.	Date Completed	Status
9 9 0 0 8 9	R M 0 6 E - 0 0 0 0 X X X	1 1 - 0 5 - 2 0 1 4	M I
			M I
			M I

If you have any questions about proper procedures for Factory Modification Campaigns, see Chapter 7 in your **Warranty and Y.E.S. Handbook** (LIT-11760-00-08).



YAMAHA MOTOR CORPORATION, U.S.A. 6555 Katella Avenue, Cypress, CA 90630-5101 (800) 962-7926

IMPORTANT SAFETY RECALL NOTICE

October 31, 2014

This notice applies to your vehicle, (VIN XXXXXXXXXXXXXXXXX)

Dear Yamaha Owner:

This notice is sent to you in accordance with the requirements of the National Traffic and Motor Vehicle Safety Act. Yamaha Motor Corporation, U.S.A. has decided that a defect which relates to motor vehicle safety exists in all 2015 FZ07F and FZ07FC ("FZ-07") model motorcycles. Our records show that you own the affected motorcycle shown above.

The reason for this recall:

In affected motorcycles, there is a possibility for the positive (red) battery cable to be pinched between the seat base and seat bracket due to inappropriate length of the battery cable and the shape of the seat bracket. If this happens, the positive battery cable's insulation may be chafed away over time, resulting in sparks, increasing the risk of fire.

What Yamaha and your dealer will do:

To correct this defect, your authorized Yamaha dealer will replace the positive battery cable and seat bracket with new ones of a different design and add a revision sticker to your Owner's Manual to show the new positive battery cable routing. The procedure takes about 45 minutes to perform, but your dealer may need to keep your motorcycle longer depending upon their schedule. **There will be no charge to you for this procedure.**

What you should do now:

Please call your Yamaha dealer to make a service appointment to have this procedure performed. At that same time, you can find out how long they expect to keep your motorcycle for this service. Remember to bring your Owner's Manual and this letter with you when you take in your motorcycle.

You should not ride your motorcycle until this modification is performed.

If you are unable to return to the Yamaha dealer who sold you the motorcycle, this service will be performed by any authorized Yamaha Motorcycle dealer. For the name of a dealer near you, call 1-800-88-YAMAHA or visit the Yamaha web site at: www.yamaha-motor.com.

If you have had this repair performed before you received this letter, you may be entitled to receive reimbursement for the cost of obtaining a pre-notification remedy of the problem associated with this repair. For more information, contact Yamaha Customer Relations at 1-800-962-7926.

Federal regulations require that any vehicle lessor receiving this recall notice must forward a copy of this notice to the lessee within 10 days.

If you need help:

If, after contacting your dealership, you have questions or concerns which the dealership is unable to answer, please write to:

Yamaha Motor Corporation, U.S.A.
Customer Relations Department
P.O. Box 6555
Cypress CA 90630
or call 1-800-962-7926.

If, after contacting Yamaha Customer Relations, you are still not satisfied that we have done our best to remedy the situation without charge and within a reasonable time, you may submit a written complaint to the Administrator, National Highway Traffic Safety Administration, 1200 New Jersey Avenue, SE., Washington, DC 20590; or call the Auto Safety Hotline at 1-888-327-4236 (TTY: 1-800-424-9153); or go to <http://www.safercar.gov>. Refer to campaign 14V-657.

If you no longer own this Yamaha:

If you have sold your motorcycle to another party, please call us toll-free at 1-800-962-7926 with the name and address of the new owner, along with the serial number shown to the right of your name and address above.

We're sorry to cause you any inconvenience, but we are sincerely concerned about your safety and continued satisfaction with our products. Thank you for giving your attention to this important matter.

Sincerely,

Customer Support Group
Yamaha Motor Corporation, U.S.A.