

SB-10056232-1453

3-27-14



Ducati Service Special Tools (USD)
Models: All
Service Bulletin SVC-14-012

Date: Tuesday, May 20th, 2014
To: Dealer Principal, Service Manager; North American Dealer Network
From: Austin Gray, Technical Director; Jonathan LaForte, Technical Manager

The bulletin supersedes previously released service bulletin SVC-11-018

Dear Service Manager,

Ducati is pleased to inform you that the latest tools for Model Year 2014 have been released, along with the new comprehensive list of all recent Ducati Service specific equipment. This new tool list (in pdf format) includes all the latest the Ducati Service standard equipment, and distinguishes compulsory from optional equipment.

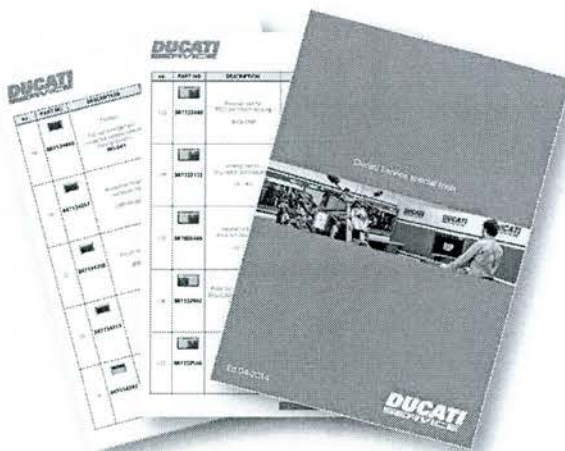

NOTE



The below mandatory tools will be auto-shipped directly by Ducati to dealers who are on the auto-ship program.



Ducati Service Special Tools
Models: All
Service Bulletin SVC-14-012

Toolboard position stickers are now available for wall cabinets, (part no.984160071), and were developed as part of the minimum standard of your workshops (please reference 2014 Ducati North America Dealer Operating Standards in the Network Development section of the Bulletin Manager on the NDCS).

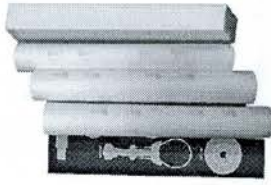
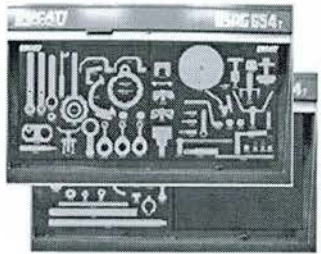
No.	PART NO.	DESCRIPTION	IMAGE	APPLICATION
1	984160071	Tool stickers for wall cabinet		

These stickers, which were designed to be applied on Ducati Service wall cabinets (2 - USAG 654 wall cabinets part no. 887131876, part of your workshop minimum tooling), will let you arrange the compulsory Ducati Service special tools in a tidy and efficient manner. Please remember that the tooling for the Panigale SBK family models already has a specific layout in the dedicated Panigale toolboxes.

Wall cabinet stickers KIT part no.984160071 includes three different stickers, 60 cm x 70 cm, that must be applied in the tool hook support grid, following the sequence illustrated in the images below:

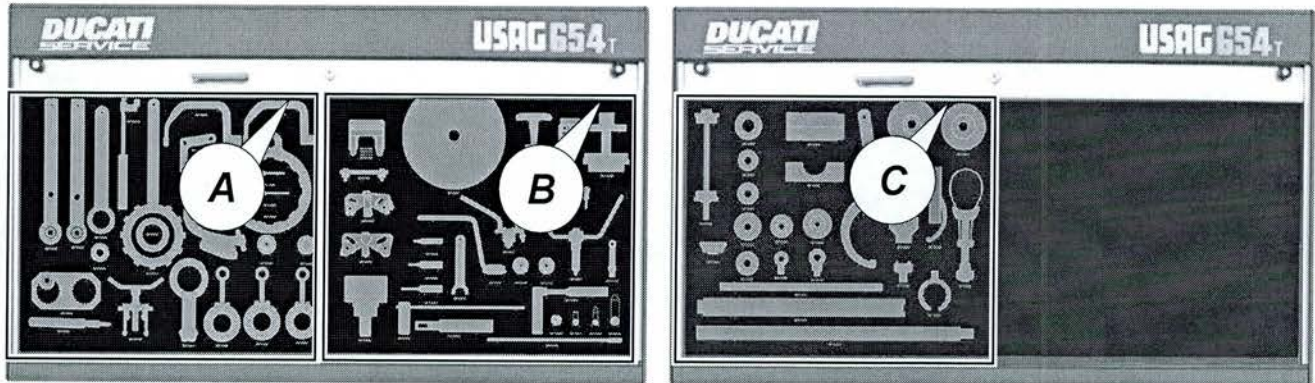

Follow the below procedure to apply the stickers correctly:

- 1) Remove all tools in the wall cabinets.



Ducati Service Special Tools
Models: All
Service Bulletin SVC-14-012

- 2) Remove all tool holder hooks.
- 3) Properly clean all sticker application area with an appropriate degreaser.

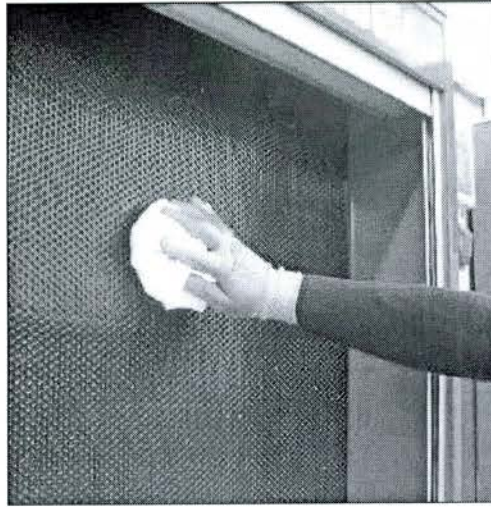

- 4) Take the first sticker and place it starting from the lower corner on the left and aligning the lower edge of the sticker with the lower edge of the wall cabinet grid support. Secure the sticker in the correct position with some pieces of paper tape.

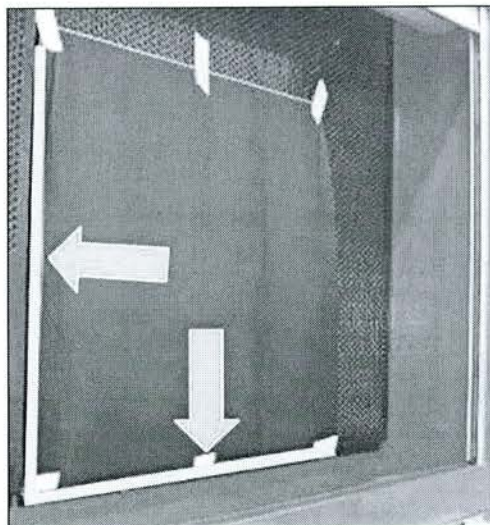



Ducati Service Special Tools
Models: All
Service Bulletin SVC-14-012

- 5) Lift the sticker left side and removing the protective paper base by 10 cm.
Apply the sticker to the surface of the wall cabinet and, working in small steps to the right, gradually remove the paper film. Pass your hand over the applied sticker to ensure proper adhesion.

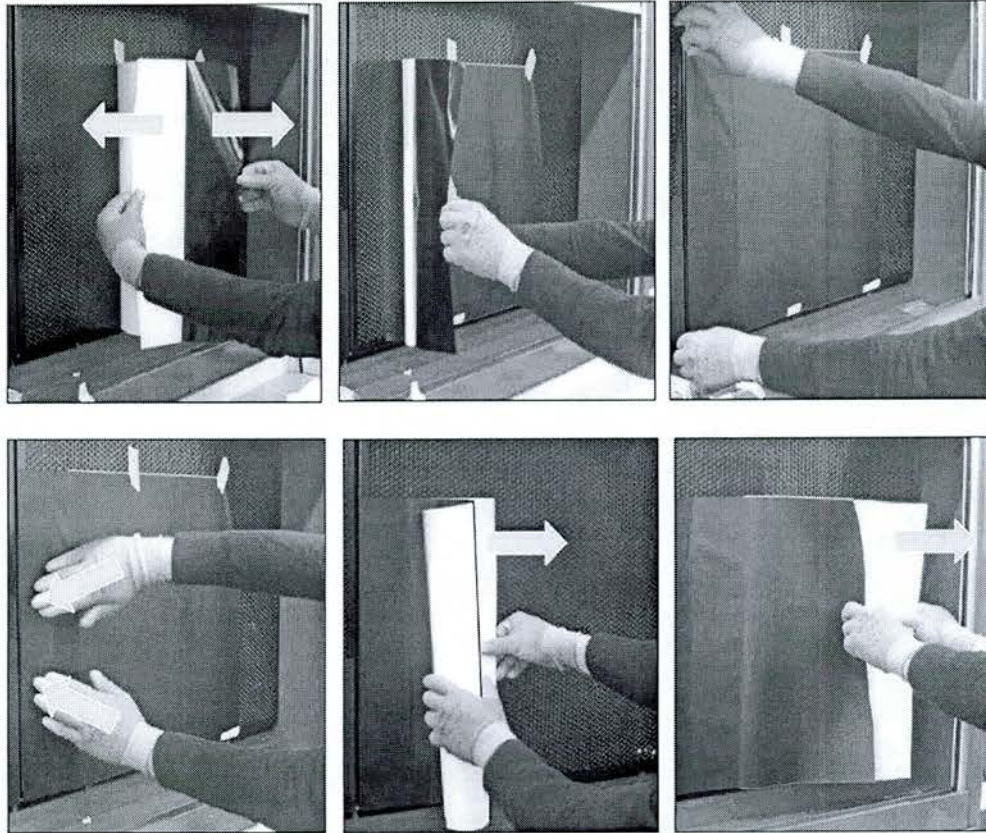

- 6) Once the sticker is completely applied, pass your hand on it to make it completely adhere.
- 7) Apply the other stickers in their respective areas of the wall cabinets using this same method described from point 3 to point 6.



Ducati Service Special Tools
Models: All
Service Bulletin SVC-14-012

- 8) Fix all tool support hooks in the areas indicated by the symbol "+" in the stickers; pay ATTENTION because the symbol identifies exactly the point/axis corresponding to support hook rod.

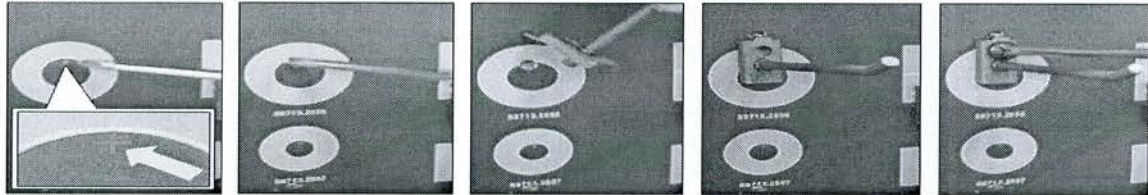

- 9) Place the tools in the drawn positions, following the indicated part numbers



IMPORTANT

- Wait **12 hours** after the stickers' application to let the glue polymerize correctly.
- The minimum application temperature is **50°F**.
- The ambient temperatures must be higher than **- 22°F** and lower than **194°C**.
- The product must be stored in warehouse at **72°F** for max. **2 years**.
- For the sticker cleaning, use alcohol or glass cleaning products, avoid solvents.



Ducati Service Special Tools
Models: All
Service Bulletin SVC-14-012

Additional tools developed for Model Year 2014:

- Engine frame for the **Monster 1200** (Part no. 887134513) will let you reassemble the motorcycle chassis, so that you can move it around inside the workshop, if the engine has been removed (this is a similar tool to the one already developed for 1199 Panigale).

This tool is compulsory and will be auto-shipped.

No.	PART NO.	DESCRIPTION	IMAGE	APPLICATION
2	887134513	Engine frame (Monster 1200)		

- Socket for removing OHLINS fork plug for **1199 Superleggera** – (Part no.887134743).



NOTE

ONLY the dealers with 1199 Superleggera will receive this tool via auto-ship.

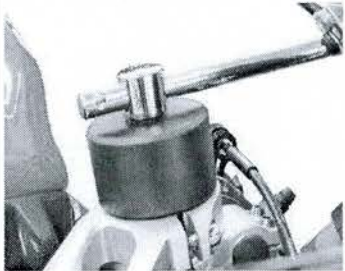
No.	PART NO.	DESCRIPTION	IMAGE	APPLICATION
3	887134743	Socket for removing the plug (OHLINS fork) (1199 Superleggera)		



Ducati Service Special Tools
Models: All
Service Bulletin SVC-14-012

- Battery charger/maintainer for lithium-ion batteries (part no. 69924821A) with suitable adapter for motorcycle connector part no. 51040111A for the **1199 Superleggera**.





NOTE

ONLY the dealers with 1199 Superleggera will receive this tool via auto-ship.



NOTE

This is the only charger approved by Ducati for use with the 1199 Superleggera. Use of any other charger during service of the motorcycle could result in damage to the battery and/or motorcycle that would not be covered under the Limited Warranty (see bulletin SVC-14-016)

No.	PART NO.	DESCRIPTION	IMAGE	APPLICATION
4	69924821A	Battery charger/ maintainer for lithium-ion batteries (1199 Superleggera)		
5	51040111A	Adapter for motorcycle connector for battery charger/ maintainer for lithium-ion batteries (1199 Superleggera)		



Ducati Service Special Tools
 Models: All
 Service Bulletin SVC-14-012

Optional tool:

- Adapter for piston pin circlip insertion tool (part no. 887134747) for **1199 Superleggera** (to be used with part no.887133502).

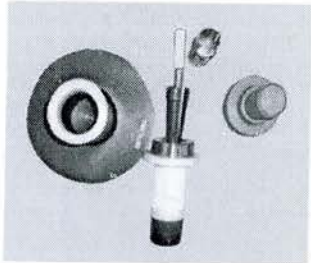
No.	PART NO.	DESCRIPTION	IMAGE	APPLICATION
6	887134747 <u>Optional tool</u>	Adapter for circlip insertion tool on piston pin (1199 Superleggera) (to be used with part no. 887133502)		

New tool list price summary:

COMPULSORY tools				
No.	Part no.	Description	Retail price USD	Dealer Net USD
1	984160071	Tool placement stickers for wall cabinet	\$55.54	\$49.99
2	887134513	Engine frame (Monster 1200)	\$307.20	\$276.48

COMPULSORY tools for 1199 Superleggera				
No.	Part no.	Description	Retail price USD	Dealer Net USD
3	887134743	Socket for removing plug (OHLINS fork) (1199 Superleggera)	\$39.05	\$35.15



Ducati Service Special Tools
Models: All
Service Bulletin SVC-14-012

4	69924821A	Battery charger/maintainer for lithium-ion batteries (1199 Superleggera)	\$156.21	\$140.59
5	51040111A	Adapter for motorcycle connector for battery charger/maintainer for lithium-ion batteries (1199 Superleggera)	\$24.30	\$21.87

OPTIONAL tools				
No.	Part no.	Description	Retail price USD	Dealer Net USD
6	887134747	Adapter for circlip insertion tool on piston pin (1199 Superleggera)	\$38.18	\$34.36

IMPORTANT:

All dealers that signed the auto-shipment agreement will receive the above noted tools. As these are required tools, dealers that did not sign the auto-shipment agreement must order the tools using the part number listed above.

Dealers with parts accounts that are not in good standing will not be auto-shipped the tools. Please place a manual order with Ducati North America via the Credit Hold Order Form.

These tools are designed to support Service activities, as part of Ducati's commitment to making available all necessary tools in order to offer end users top-notch After Sales Service - a key to business success. It should also be noted that failure by a dealer to acquire these critical tools immediately may constitute a breach of their dealer agreement.

We trust these new tools will further enhance the premium level of your Service Department.

Ducati North America
Service Department