



# SB-10056218-3357

Gulf States Toyota, Inc.  
1375 Enclave Parkway  
Houston, TX 77077

To: All Dealer Principals, General Managers, Service Managers, Parts Managers

Subject: **Special Service Campaign - 14R1**  
Certain 2012 through 2014 Toyota Prius V Vehicles Equipped with Non-Toyota Seat Heater

**Background:**

Gulf States Toyota, Inc. (GST) will initiate a Special Service Campaign (SSC) on certain 2012 - 2014 Toyota Prius V vehicles equipped with a non-Toyota seat heater system. The SSC involves approximately 682 seat heater systems installed on select 2012 - 2014 model year Toyota Prius V vehicles. These non-Toyota seat heater systems were installed as a GST installed option under GST P/N 00015-J1248-01.

**Condition:**

The non-Toyota seat heater installed in these vehicles by GST could stop working due to a failure of the wiring connectors. If this occurs, the seat heater will turn off and no longer work.

Should you be contacted by an owner regarding this program, please verify eligibility for this repair by referring to the affected VIN listing on the Campaign tab in the TIS Vehicle Inquiry screen, or on the GST LIO Warranty System Super Screen.

Please review this entire package with your Service and Parts staff to familiarize them with the proper procedures and implementation of this program to ensure customer satisfaction.

**Remedy Procedures:**

Please refer to the Technical Instructions which are posted on the Campaign tab in the TIS Vehicle Inquiry screen. You can also find these document links on the Warranty Page of the GST region Dealer Daily System.

*Conduct all applicable open Recalls and Service Campaigns on the vehicle during time of appointment.*

**Owner Notification Mailing Date:**

The owner notification will commence in mid-August.

**Identification of Involved Vehicles:**

Please verify eligibility by confirming through the TIS Vehicle Inquiry under the Campaign tab, or on the GST LIO Warranty System Super Screen.

**Parts Requirements and Ordering:**

Parts can be obtained from the GST regional PDC, through your normal daily parts order. Parts required for each affected VIN are listed in the table below. For dealers not in Texas, Louisiana, Oklahoma, Arkansas or Mississippi, please call 1 800 444 1074 to obtain remedy parts.

Part Number	Part Description	Quantity Required per Vehicle
00012-J1448-21	Power Harness Update Kit	1

**Claim Submission and Reimbursement Procedures:**

A GST Port LIO warranty claim should be submitted, and must include the following required information.

	<b>GST Installed Product</b>	<b>DIO Installed Product</b>
<b>Failed Part Number</b>	00015-J1248-01	This product was not offered for DIO Installation and Sales.
<b>Operation Code</b>	14R1W1	
<b>Replacement Part</b>	00012-J1448-21	
<b>Trouble Code</b>	99	
<b>Condition</b>	Seat Heater Power Harness Update	
<b>Cause</b>	Customer Satisfaction	
<b>Remedy</b>	Install Power Harness Update Kit	
<b>Labor Time</b>	1.0 hrs.	

**Claim reimbursement will not take place until the wiring terminals identified for return on page 7 in the Technical Instructions have been received at the GST Parts Distribution Center. Returned Parts must be tagged with the LIO Warranty Claim Form displaying the claim number and dealer code. Follow your normal LIO warranty parts return process.**

**Customer Handling:**

Please consider this program as an opportunity to reinforce Toyota's commitment to customer safety and product quality. Customers who receive the owner letter may contact your dealership with questions regarding the letter or Special Service Campaign remedy. Our customer's confidence is our most valuable asset, so please welcome their questions and take the time necessary to communicate clearly and effectively with them. A Q&A is provided to assist you in communicating a clear and consistent message.

**Please review the entire contents of this package with your Service and Parts staff to familiarize them with the proper step-by-step procedures required to implement this Special Service Campaign.**

Thank you for your cooperation,  
GULF STATES TOYOTA, INC.

**Seat Heater Power Harness Update (SSC) 14R1**  
2012 through 2014 Toyota Prius V  
(GST Installed Seat Heater System)

**Check Applicability:**

Run the vehicle VIN number in TIS Vehicle Inquiry and check the Campaign tab. The SSC will also be visible on the GST Warranty Super Screen.

YES

Does the VIN show 14R1 as applicable ?

NO

Install the remedy parts in accordance with the GST (SSC) 14R1 Technical Instructions.

No Action Necessary.

ALL PARTS SPECIFIED FOR RETURN AS STATED ON PAGE 7 IN THE TECHNICAL INSTRUCTIONS MUST BE RETURNED TO GST. WARRANTY CLAIM PAYMENT WILL BE DENIED UNTIL PARTS HAVE BEEN RECEIVED !

Return the vehicle to the customer and completely explain what work was performed.

**Warranty Info: (SSC) 14R1.**

OP Code: 14R1W1  
Labor Time: 1.0 Hrs.  
Failed Part #: 00015-J1248-01

**Parts Required:**

Pwr Harness Update Kit P/N 00012-J1448-21



Special Service Campaign- 14R1  
Certain 2012 through 2014 Toyota Prius V Vehicles Equipped with LIO Installed Seat Heater  
Seat Heater Wiring Update - Q&A Page 1 of 1  
August 2014

Special Service Campaign (SSC) 14R1 covers certain 2012 – 2014 Toyota Prius V vehicles originally distributed in the Gulf States Toyota Region.

**Q1: What is the condition?**

A1: The non-Toyota seat heater installed in these vehicles by GST could stop working due to a failure of the wiring connectors. If this occurs, the seat heater will turn off and no longer work.

**Q2: What is the remedy?**

A2: The customer will be provided with, at no cost, an update to the seat heater wiring harness, which will replace the wiring connector.

**Q3: Will any existing parts be re-used?**

A3: Yes. The main components of the system including seat heater pads, switches and the main harness will remain intact. Wiring adaptors designed to improve the connection method will be added to the main harness.

**Q4: Are there any warnings this condition exists?**

A4: There are no specific warnings that a condition exists.

**Q5: Have any accidents occurred as a result of the condition?**

A5: There have been no reports of any failure that has resulted in an accident.

**Q6: How many vehicles are involved?**

A6: These non-Toyota seat heater systems were installed on approximately 682 vehicles at the Gulf States Toyota Vehicle Processing Center. The systems were installed on various 2012 through 2014 Prius V models only, and no other Toyota Models were equipped with this system by Gulf States Toyota.

**Q7: What should an owner do if they have immediate concerns about their vehicle?**

A7: All owners of Toyota Prius V vehicles equipped with these non-Toyota seat heater systems are eligible to receive at no cost, the parts and installation of the seat heater power harness update kit, and are encouraged to contact their local Toyota Dealer to schedule an appointment to perform the SSC .

**Q8: Will the addition of the wiring adaptors change the appearance or functionality of my Prius V?**

A8: The addition of the wiring update kit will have no effect on the appearance or the operation of the vehicle.

**Q9: How long will the Service take?**

A9: The installation of the power harness update kit will take approximately 1.0 hour. However, it may take longer based upon the dealer's work schedule.

**Q10: What if a customer has previously paid for repair of this specific condition on their vehicle?**

A10: Owners should contact the GST Customer Assistance Center toll free at 1 - 800 - 444 - 1074 for reimbursement consideration.



Gulf States Toyota, Inc.  
P.O. Box 442168  
Houston, Texas 77244-2168

**2012 – 2014 Toyota Prius v  
Non-Toyota Seat Heater Wiring Connections  
Special Service Campaign Notice**

MR. SAMPLE A. SAMPLE  
12345 SAMPLE STREET  
ANYPLACE, USA 77551-1212

**Re: Vehicle Identification Number [VIN]**

Dear Toyota Prius v Owner:

Our records indicate that you are the owner of a 2012 – 2014 Toyota Prius v that was equipped by independent distributor Gulf States Toyota, Inc. (GST) with a non-Toyota seat heater system. GST is initiating a Special Service Campaign to replace certain wiring connections. GST will replace the parts at no cost to you.

**Why is GST conducting this Special Service Campaign?**

GST is conducting this Special Service Campaign because the non-Toyota seat heater installed in vehicles by GST could stop working due to a failure of the wiring connectors. If this occurs, the seat heater will turn off and no longer work.

**What will be done?**

Your local Toyota dealer will replace all of the affected wiring connectors with upgraded connectors. The replacement is free of charge.

**What should you do?**

Contact your local Toyota dealer to schedule an appointment for installation if you are in Texas, Louisiana, Oklahoma, Arkansas, or Mississippi. Please note that an appointment will be necessary to confirm part availability. If you are outside these five states, then contact the GST Customer Assistance Center toll free at 1-800-444-1074. GST will ship the new parts to your preferred Toyota dealer and the dealer will call you to schedule an appointment for installation. The time to perform this service is approximately one hour; however, depending upon the dealer's work schedule, it may be necessary to make your vehicle available for a longer period of time.

We have sent you this notice in the interest of your continued satisfaction with our products and sincerely regret any inconvenience this Special Service Campaign may cause you.

Sincerely,

Gulf States Toyota, Inc.  
Re: SSC# 14R1

**Gulf States Toyota, Inc.**  
**GST SSC - 14R1**  
**2012-2014 Prius V Seat Heater**  
**P/N 00012-J1448-21 Power Harness Update**  
**Technical Instructions**

***INSPECTION:***

1. Verify VIN applicability using the Warranty Super Screen, or by checking the Warranty tab under Vehicle inquiry in the Toyota TIS system.
2. Confirm you have the correct Power Harness Update kit prior to proceeding.

***PARTS OVERVIEW:***

1. The update kit should include the following parts ...
  - A. (1) System Ground Extension (BROWN) Wire.
  - B. (1) Passenger Front Seat Power Extension (BLUE) Wire.
  - C. (1) Driver's Seat Power Extension (RED) Wire.
  - D. (3) 6" Long Cable Ties (not shown in diagram).

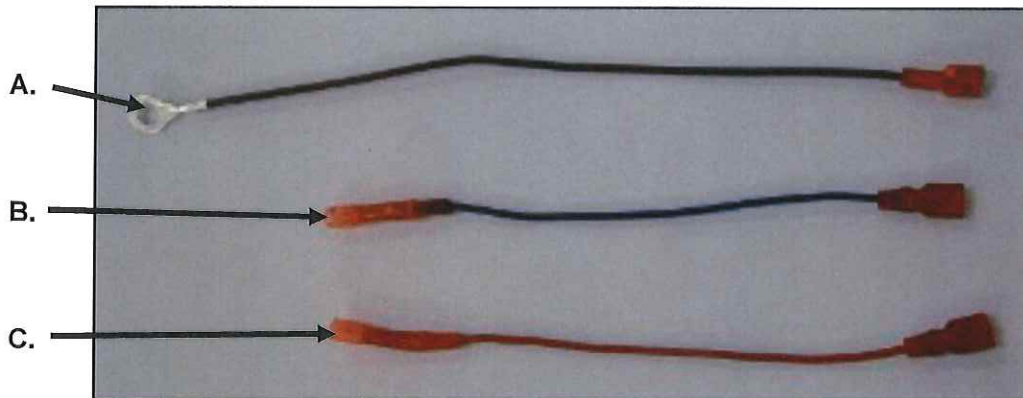

***VEHICLE PREPARATION:***

1. Follow all procedures as outlined in the Repair Manual to properly disconnect the Negative Battery Terminal.
2. Place protective covers on front seats and console area.



Gulf States Toyota, Inc.  
GST SSC - 14R1  
2012-2014 Prius V Seat Heater  
P/N 00012-J1448-21 Power Harness Update  
Technical Instructions

**VEHICLE PREPARATION (continued):**

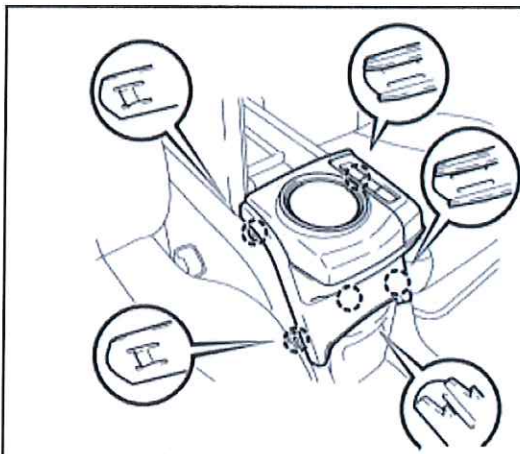

Figure 3a.

3. To remove the Upper Console Panel, carefully disengage the 5 claws, then unplug the connector and place the panel aside where it cannot be damaged.



Figure 3b.

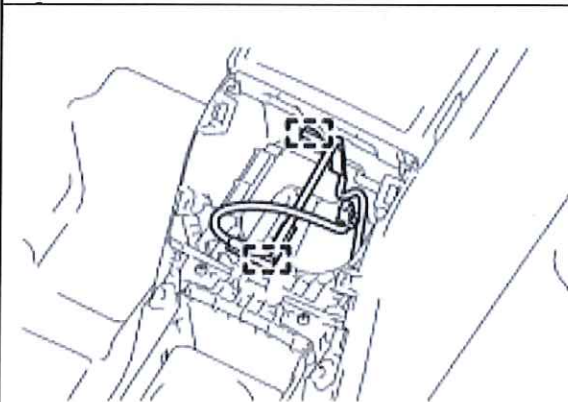

Figure 4a.

4. Disengage (3) harness clamps from the console box.

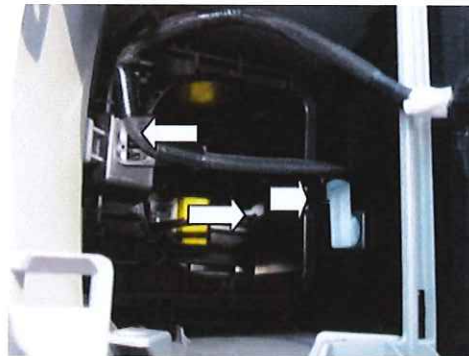

Figure 4b.

Gulf States Toyota, Inc.  
GST SSC - 14R1  
2012-2014 Prius V Seat Heater  
P/N 00012-J1448-21 Power Harness Update  
Technical Instructions

**VEHICLE PREPARATION (continued):**

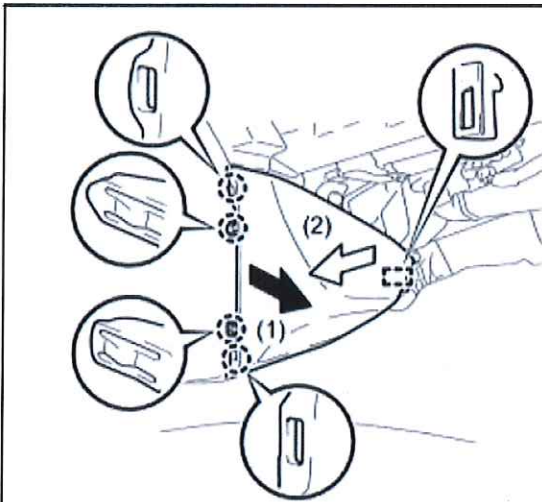

Figure 5a.

5. Carefully remove the Right Front center floor carpet cover panel and set it aside where it cannot be damaged.



Figure 5b.

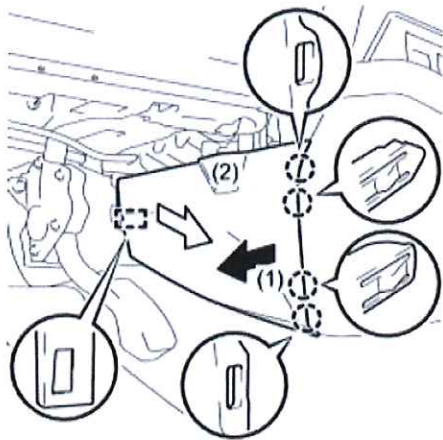

Figure 6a.

6. Carefully remove the Left Front center floor carpet cover panel and set it aside where it cannot be damaged.



Figure 6b.



**Gulf States Toyota, Inc.**  
**GST SSC - 14R1**  
**2012-2014 Prius V Seat Heater**  
**P/N 00012-J1448-21 Power Harness Update**  
**Technical Instructions**

**VEHICLE PREPARATION (continued):**

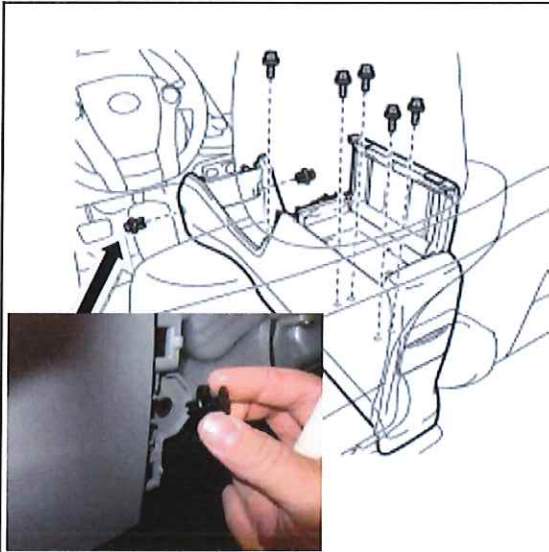

Figure 7a.

7. Remove the (5) 10mm bolts from the center console, then remove the clip from each front corner, and remove the console and set it aside where it cannot be damaged.



Figure 7b.



Figure 8a.

8. Disengage the (8) claws, disconnect the connectors, then remove the integration control panel and set it aside where it cannot be damaged.



Figure 8b.

Gulf States Toyota, Inc.  
GST SSC - 14R1  
2012-2014 Prius V Seat Heater  
P/N 00012-J1448-21 Power Harness Update  
Technical Instructions

**VEHICLE PREPARATION (continued):**

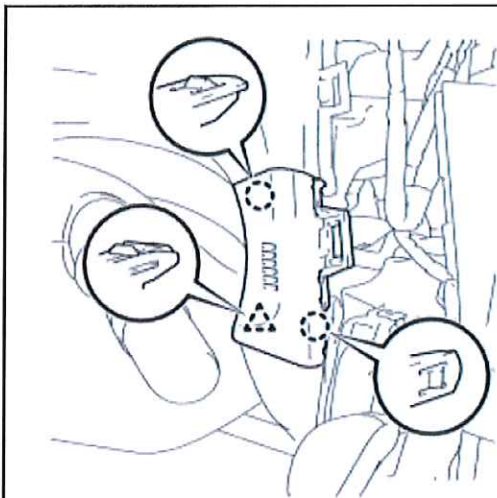

Figure 9a.

9. Disengage the (2) claws and the clip, then remove the upper instrument panel finish panel and set it aside where it cannot be damaged.



Figure 9b.

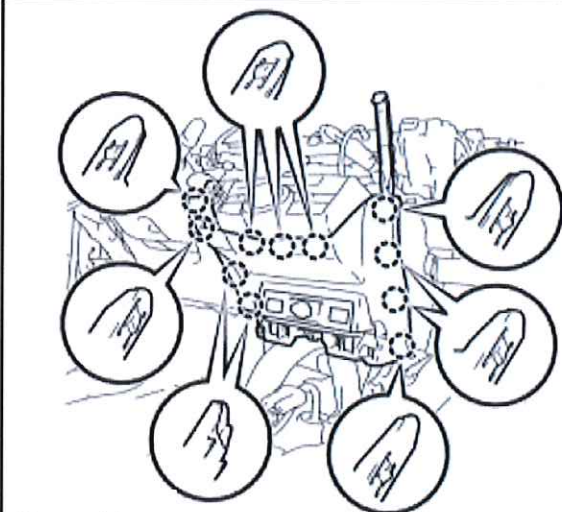

Figure 10a.

10. Disengage the (11) claws and a single clamp, disconnect the connectors, then remove the lower instrument finish panel sub-assembly and set it aside where it cannot be damaged.



Figure 10b.

Gulf States Toyota, Inc.  
GST SSC - 14R1  
2012-2014 Prius V Seat Heater  
P/N 00012-J1448-21 Power Harness Update  
Technical Instructions

**VEHICLE PREPARATION (continued):**

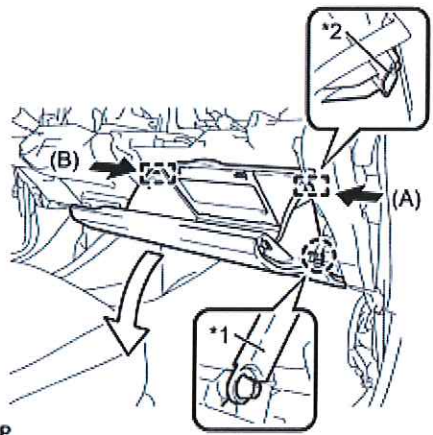

11. Open the glove compartment door, disengage the claw and release the glove compartment door stopper sub-assembly. Then slightly bend stoppers (A & B) in the direction of the arrows shown and pull the glove compartment door assembly until the stoppers are released.

Figure 11

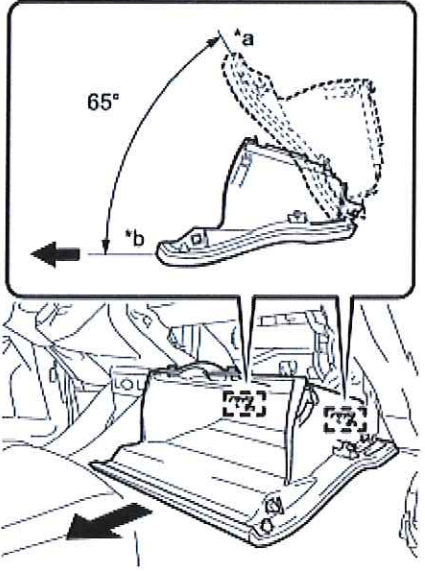

12. Open the glove compartment door assembly to approximately 65 degrees, then carefully pull it horizontally in the direction of the arrow to disengage the (2) hinges. Set it aside where it cannot be damaged.

NOTE: Use care and pull horizontally so the hinges will not be damaged.

Figure 12



Gulf States Toyota, Inc.  
 GST SSC - 14R1  
 2012-2014 Prius V Seat Heater  
 P/N 00012-J1448-21 Power Harness Update  
 Technical Instructions

**INSTALLING THE POWER HARNESS UPDATE (continued):**

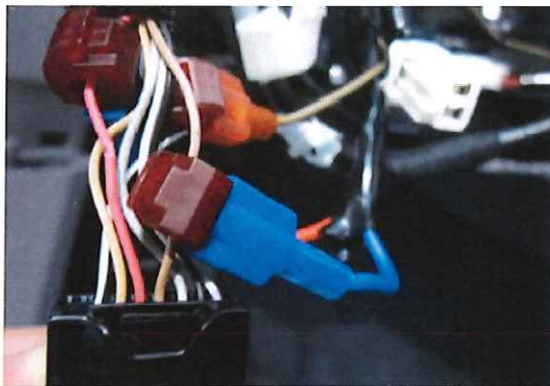

Figure 13

13. Locate connector L26 in the lower center console opening. This is an 8 pin black connector which will have (3) wires from the Seat Heater connected to it.

Seat Heater Wire Color	OEM Wire Color	Connector L26 Pin Number
BR	W-B	2
R	R	4
L	BR	5

L26 ( 8 Pin Black Connector)

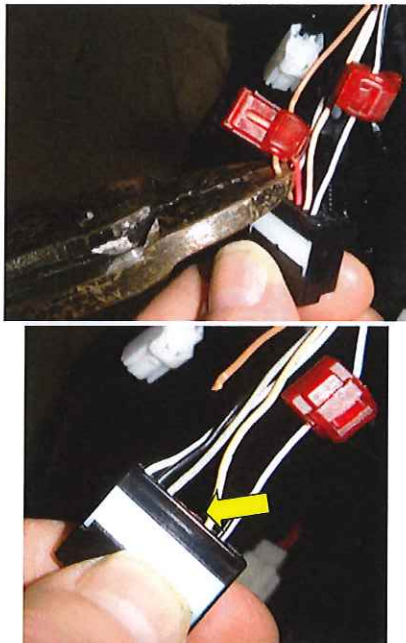
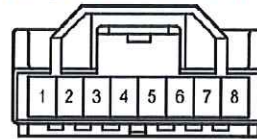

Figure 14

14. Unplug the (3) Seat Heater Wires from the T-Tap terminals at the back of connector L26. Then, cut the T-Tap terminals off the RED and the BROWN OEM wires, cutting the OE wire at both sides of the T-Tap. **BE SURE TO CUT THE RED AND BROWN WIRES AS CLOSE TO CONNECTOR L26 AS POSSIBLE, AS INDICATED BY THE YELLOW ARROW BELOW LEFT.**

NOTE: The 3rd T-Tap should remain connected to the OEM WHITE/BLACK striped wire.

**IMPORTANT !!!** Save the (2) T-Taps that were cut from the harness. These parts **MUST BE** returned to the PDC when the LIO Warranty claim is filed. Claims will not be paid and VINs will not be cleared until the (2) parts with wire are received at the Parts Distribution Center.

Gulf States Toyota, Inc.  
GST SSC - 14R1  
2012-2014 Prius V Seat Heater  
P/N 00012-J1448-21 Power Harness Update  
Technical Instructions

**INSTALLING THE POWER HARNESS UPDATE (continued):**

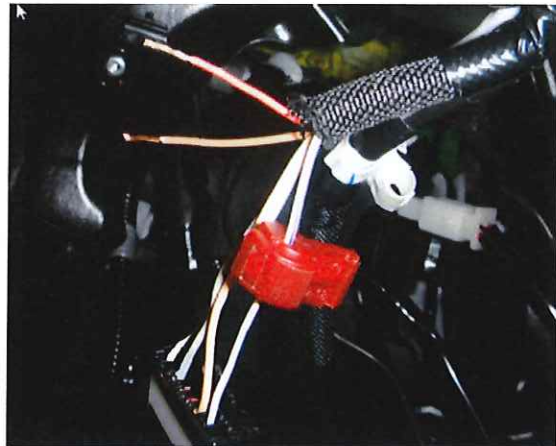

Figure 15

15. Carefully strip back 3/8" of insulation from the OEM Red and Brown wires, at the harness side of the wire.

**IMPORTANT !** This is a 22 AWG wire. Be sure to use the correct wire stripping tool, and be sure that no copper wire strands are removed from the wire during the stripping process.

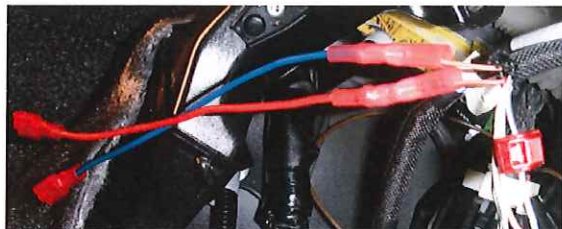
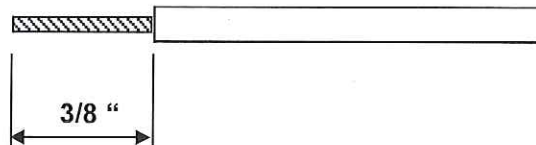

Figure 16

16. Using 3M crimp tool TH-440 or equivalent, crimp the Passenger Front Seat Power Extension (BLUE) Wire included in this kit to the OEM BROWN wire previously inserted into Connector L26, Pin 5.

Crimp the Driver's Seat Power Extension (RED) Wire included in this kit to the OEM RED wire previously inserted into Connector L26, Pin 4.

**IMPORTANT !** After crimping each wire, apply 11 lbs of pull force to ensure the crimp is secure.



Gulf States Toyota, Inc.  
GST SSC - 14R1  
2012-2014 Prius V Seat Heater  
P/N 00012-J1448-21 Power Harness Update  
Technical Instructions

**INSTALLING THE POWER HARNESS UPDATE (continued):**

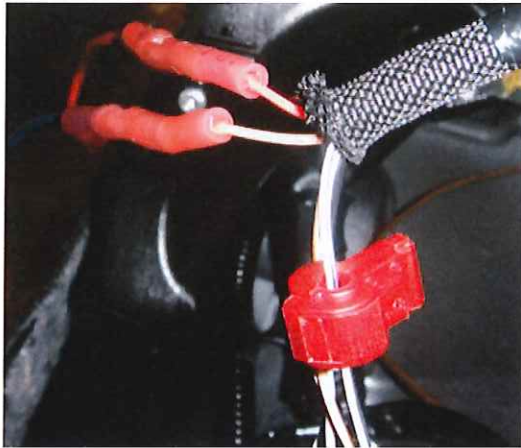

17. Using a concentrated heat source or heat gun at **MEDIUM** setting, shrink the insulation at the crimped end of the butt splice down over the OEM wire insulation.

**IMPORTANT !** Be sure to protect all finish panels and parts including OEM connectors from the heat source. Use extreme care and demonstrate patience when shrinking the tubing.

Figure 17



18. Locate the factory ground location L2 behind the upper left corner of the glove box opening. Using a 10mm socket, connect the ring terminal on the System Ground Extension (BROWN) Wire included in this kit to factory ground location L2 and torque to factory specification.

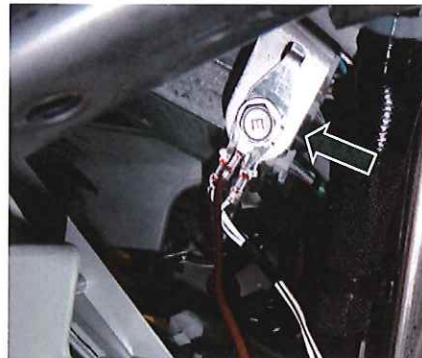

Figure 18



Gulf States Toyota, Inc.  
GST SSC - 14R1  
2012-2014 Prius V Seat Heater  
P/N 00012-J1448-21 Power Harness Update  
Technical Instructions

**INSTALLING THE POWER HARNESS UPDATE (continued):**

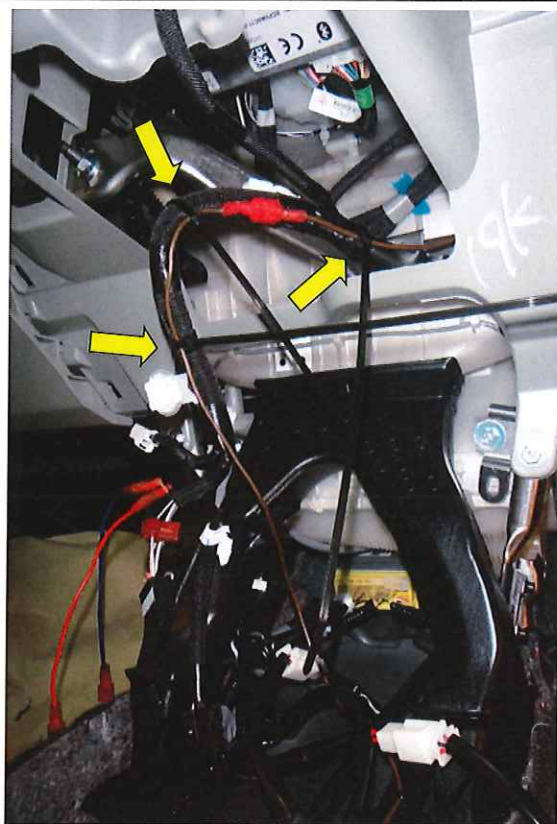

Figure 19

19. Route the insulated female terminal end of the BROWN extension wire into the center console area, and plug it into the male insulated terminal on the end of the BROWN wire from the seat heater harness.

Plug the insulated female terminal end of the RED extension wire into the male insulated terminal on the end of the RED wire from the seat heater harness.

Plug the insulated female terminal end of the BLUE extension wire into the male insulated terminal on the end of the BLUE wire from the seat heater harness.

Install the (3) wire ties as shown at the three yellow arrows. Be sure to trim the excess wire tie extension prior to re-assembly.

**Gulf States Toyota, Inc.**  
**GST SSC - 14R1**  
**2012-2014 Prius V Seat Heater**  
**P/N 00012-J1448-21 Power Harness Update**  
**Technical Instructions**

**20. Temporarily re-connect the negative battery terminal in accordance with the Repair Manual, and test the seat heater system. Be sure to test both seats.**

**21. Follow all procedures as outlined in the Repair Manual to properly disconnect the Negative Battery Terminal.**

**22. Re-assemble all removed parts and panels in accordance with the vehicle Repair Manual.**

**23. Permanently re-connect the Negative Battery Terminal and re-initialize any systems necessary per the vehicle Repair Manual.**

**24. Connect a Techstream unit to the vehicle and perform a Health Check to determine that all systems are fully functional, prior to delivering the vehicle to the customer.**

**NOTE: The Health Check MUST BE performed while the vehicle is inside the dealer service area and while the Techstream unit is connected to the network.**