	GROUP Service Campaign	MODEL 2005~2010MY Sportage (KM)
	NUMBER SC104	DATE April 2014
VOLUNTARY SERVICE CAMPAIGN		
SUBJECT: APPLICATION OF ADDITIONAL ANTI-CORROSION MATERIAL (SC104)		

To improve customer satisfaction, Kia is launching this bulletin to apply additional anti-corrosion protection to various vehicle underbody components on some Sportage (KM) vehicles, built from June 24, 2004 through January 26, 2010. The affected vehicles are mainly those currently registered in states where heavy amounts of road salt are used in the winter months. The 21 states which are known to use heavy amounts of road salt are: CT, DC, DE, IA, IL, IN, MA, MD, ME, MI, MN, MO, NH, NJ, NY, OH, PA, RI, VT, WI and WV. In addition, those Sportage (KM) vehicles later registered in those states shall also be entitled to the additional protection. Kia believes that such additional protection can be helpful, especially in very high mileage situations. Please remind all customers of the instructions in their Owner's Manual, as shown below, (2005-2008MY: Page 7-65 and 2009-2010MY: Page 7-64) to regularly have the underbody of their vehicles washed when road salt is being used in their area.

“Underbody maintenance

Corrosive materials used for ice and snow removal and dust control may collect on the underbody. If these materials are not removed, accelerated rusting can occur on underbody parts such as the fuel lines, frame, floor pan and exhaust system, even though they have been treated with rust protection. Thoroughly flush the vehicle underbody and wheel openings with lukewarm or cold water once a month, after off-road driving and at the end of each winter. Pay special attention to these areas because it is difficult to see all the mud and dirt. It will do more harm than good to wet down the road grime without removing it. The lower edges of doors, rocker panels, and frame members have drain holes that should not be allowed to clog with dirt; trapped water in these areas can cause rusting.”

*** NOTICE**

To assure complete customer satisfaction, always remember to refer to WebDCS Warranty Coverage (validation) Inquiry Screen (Service > Warranty Coverage >Warranty Coverage Inquiry) for a list of any additional campaigns that may need to be performed on the vehicle before returning it to the customer.

File Under: <Service Campaign>

- Circulate To:
 General Manager
 Service Manager
 Parts Manager
 Service Advisor(s)
 Technician(s)
 Body Shop Manager
 Fleet Repair

SUBJECT: APPLICATION OF ADDITIONAL ANTI-CORROSION MATERIAL (SC104)

Cleaning Procedure:

! WARNING

To prevent possible injury, make sure to wear eye and ear protection while performing the procedures described within. In addition, a dust mask should be worn to prevent inhaling any airborne rust particles or chemical vapors.

1. Use a metal bristle brush to clean and remove any rust scales or contaminants from all surfaces of each front lower control arm.

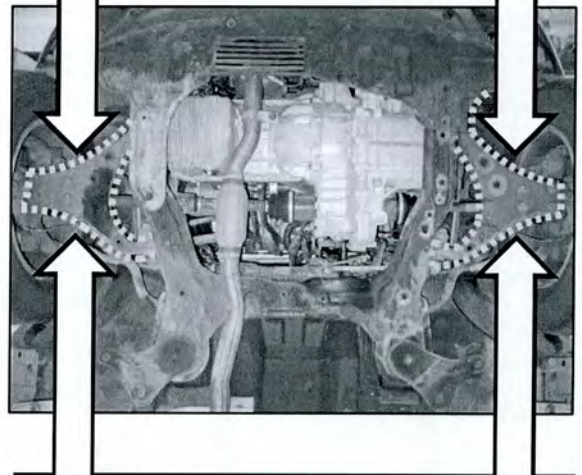
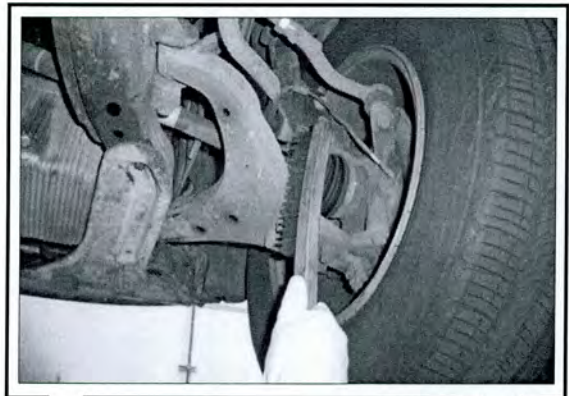

2. Remove any debris from the inside of each front lower control arm using an air gun. Make sure to insert the nozzle in multiple holes and rotate it in all directions to completely remove any foreign material or rust flakes.



SUBJECT:

APPLICATION OF ADDITIONAL ANTI-CORROSION
MATERIAL (SC104)

3. Use a metal bristle brush to clean and remove any rust scales or contaminants from all surfaces of the sub-frame.

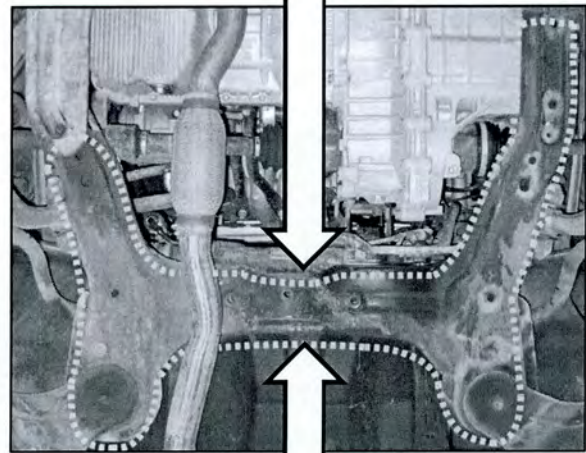
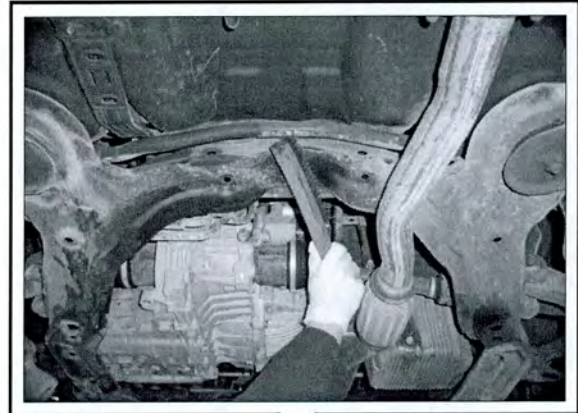

4. Remove any debris from the inside of the sub-frame using an air gun. Make sure to insert the nozzle in multiple holes and rotate it in all directions to completely remove any foreign material or rust flakes.

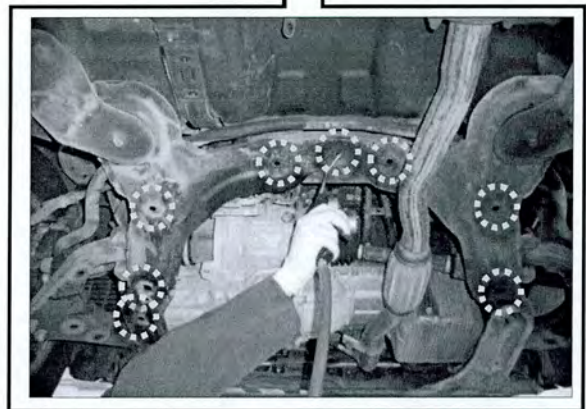

SUBJECT:

APPLICATION OF ADDITIONAL ANTI-CORROSION MATERIAL (SC104)

*** NOTICE**

This procedure is shown being performed on a 2WD Sportage. 4WD Sportage models feature a different rear cross member design. All steps illustrated below should be performed in a similar fashion on 4WD models.

5. Use a metal bristle brush to clean and remove any rust scales or contaminants from all surfaces on the rear lower control arms and trailing arms.

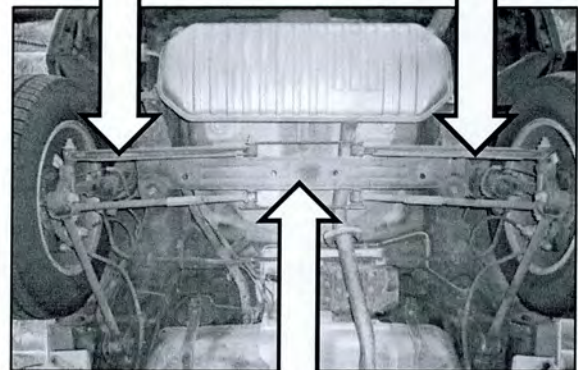
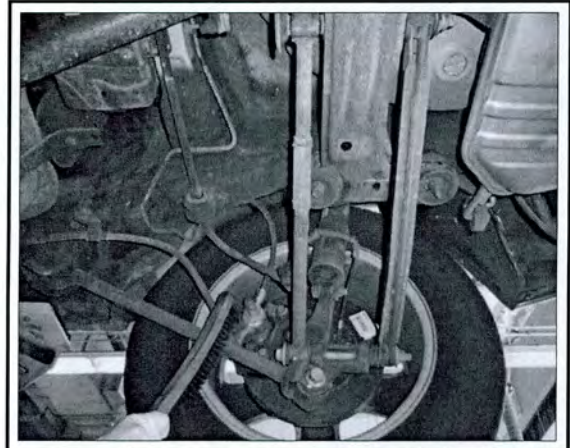

6. Use a metal bristle brush to clean and remove any rust scales or contaminants from all surfaces of the rear cross member.



SUBJECT:

APPLICATION OF ADDITIONAL ANTI-CORROSION
MATERIAL (SC104)

7. Remove any remaining contaminants from the rear control arms and trailing arms using an air gun.

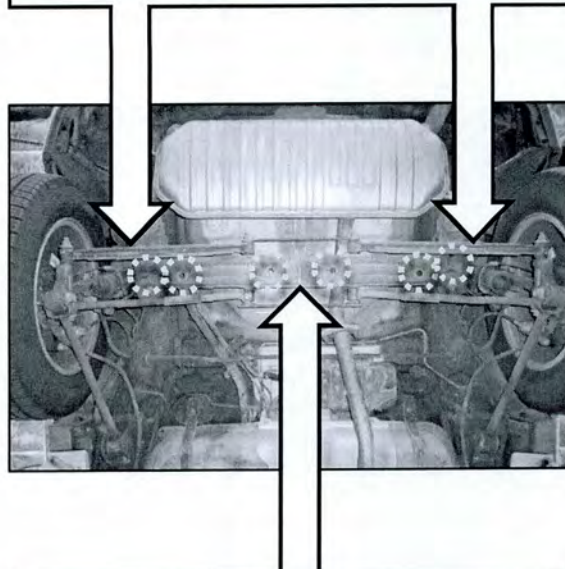
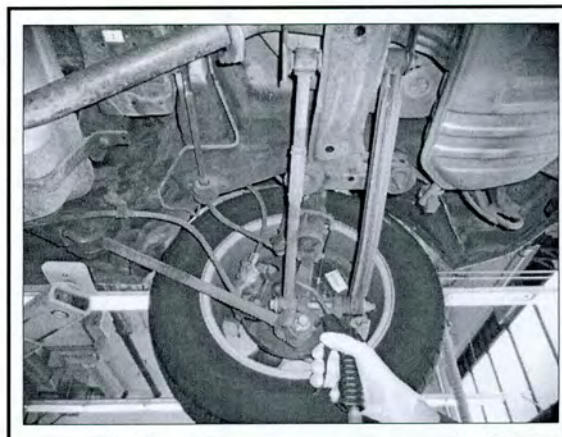

8. Remove any debris from the inside of the cross member using an air gun. Make sure to insert the nozzle in multiple holes and rotate it in all directions to completely remove any foreign material or rust flakes.



SUBJECT:

APPLICATION OF ADDITIONAL ANTI-CORROSION
MATERIAL (SC104)

9. Use an air gun to remove debris or foreign material from all exposed surfaces of the fuel tank.

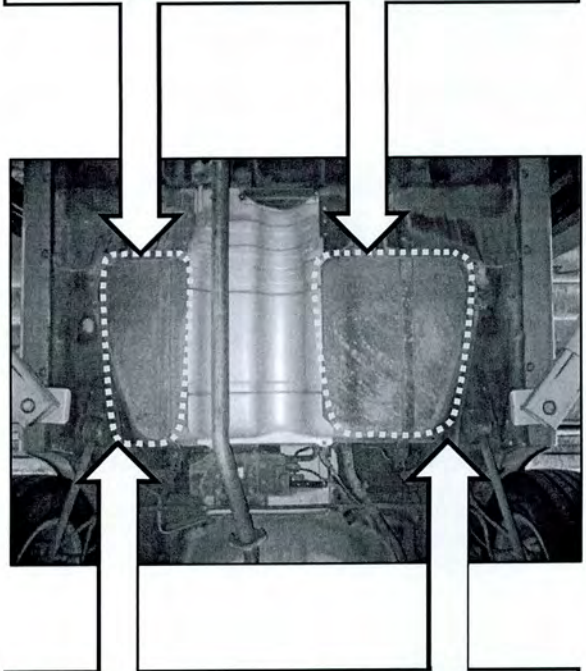
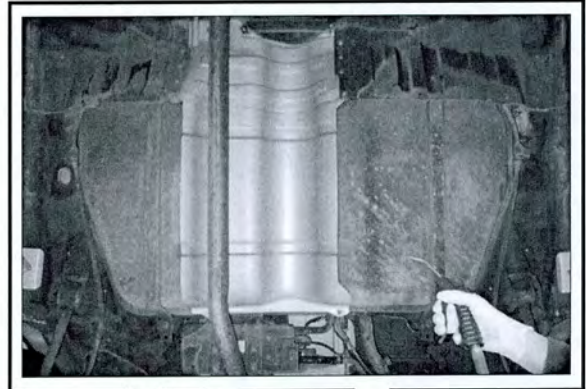

SUBJECT:

APPLICATION OF ADDITIONAL ANTI-CORROSION MATERIAL (SC104)

Application of Cavity Wax and Undercoating:

! WARNING

To avoid possible injury, this procedure must be performed in a well-ventilated area and safety glasses must be worn at all times. In addition, do **NOT** smoke and avoid open flames while applying cavity wax and undercoating, as they are highly flammable!

*** NOTICE**

- This procedure should **ONLY** be performed in temperatures above 32° F (0° C). Ensure that all surfaces are completely dry and free of moisture before applying cavity wax or undercoating.
- Older cavity wax inventory from previous campaigns is likely beyond use due to irregular consistency. Using old product may result in a poor spray pattern and insufficient cavity wax application. Discard any such product (following all applicable local/state/federal regulations) and use **ONLY** the newly supplied wax for this campaign (SC104). An expiration date will be added to the product so that in the future any expired wax can be easily identified and discarded. In case of questions, please contact the Kia Chemical Program through kdealer.net or by calling (800) 811-0502.”

1. Using the Wax Injection Gun, apply cavity wax into every hole in each of the front lower control arms, as shown. To evenly apply cavity wax, turn the nozzle in all directions while spraying.

! WARNING

Cavity wax is extremely flammable! Do **NOT** smoke and avoid any open flames during application, to avoid possible injury.

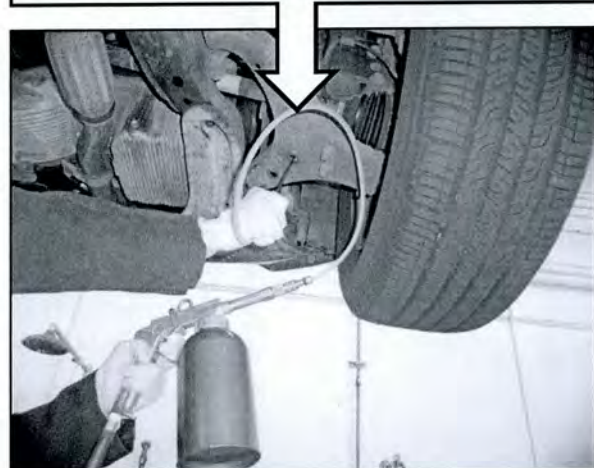
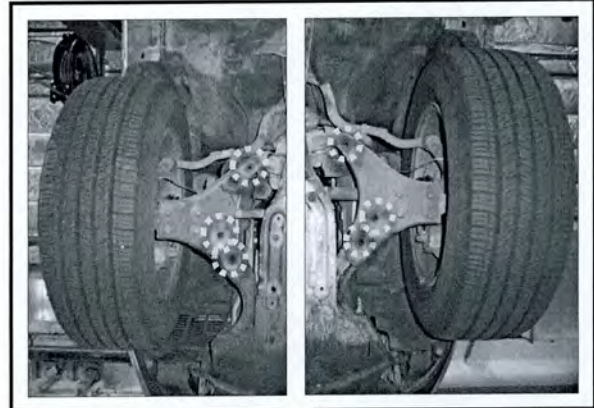

SUBJECT:

APPLICATION OF ADDITIONAL ANTI-CORROSION
MATERIAL (SC104)

2. Apply cavity wax into every hole in the sub-frame, as shown. To evenly apply cavity wax, turn the nozzle in all directions while spraying.



WARNING

Cavity wax is extremely flammable! Do NOT smoke and avoid any open flames during application, to avoid possible injury.

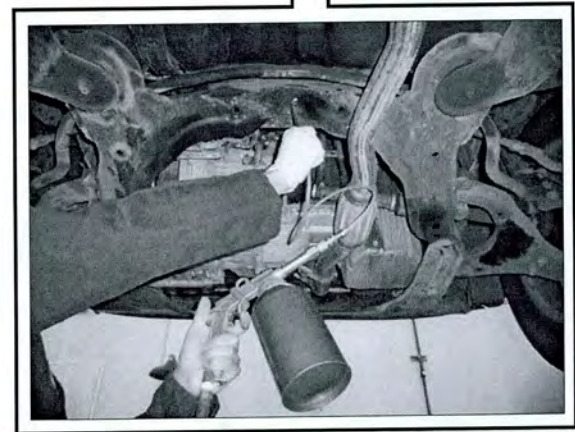
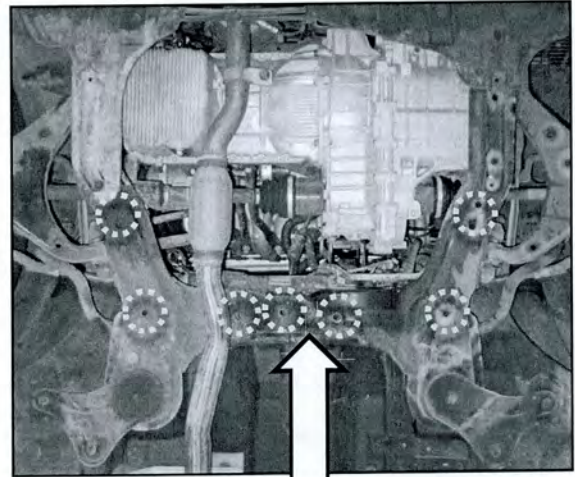

*** NOTICE**

This procedure is shown being performed on a 2WD Sportage. 4WD Sportage models feature a different rear cross member design. All steps illustrated below should be performed in a similar fashion on 4WD models.

SUBJECT:

APPLICATION OF ADDITIONAL ANTI-CORROSION
MATERIAL (SC104)

3. Apply cavity wax into every hole in the rear cross member, as shown. To evenly apply cavity wax, turn the nozzle in all directions while spraying.

**WARNING**

Cavity wax is extremely flammable! Do NOT smoke and avoid any open flames during application, to avoid possible injury.

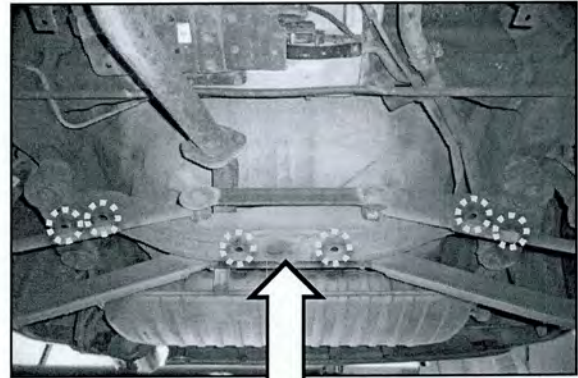

4. Apply undercoating onto the upper and lower surfaces of each front lower control arm. Avoid over-spraying other parts of the vehicle.

**WARNING**

Undercoating is extremely flammable! Do NOT smoke and avoid any open flames during application, to avoid possible injury. In addition, latex gloves and a dust mask should be worn to prevent skin contact with the undercoating or inhalation of any vapors.



SUBJECT: APPLICATION OF ADDITIONAL ANTI-CORROSION MATERIAL (SC104)

- 5. Apply undercoating onto the entire front sub-frame, as shown. Do **NOT** apply undercoating to the exhaust pipe or other unrelated parts of the vehicle.

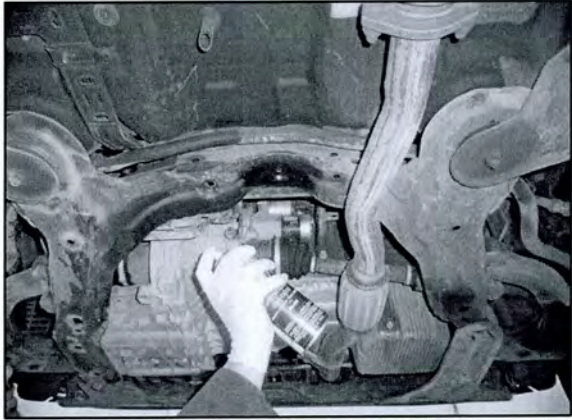

- 6. Apply undercoating onto each rear lower control arm and trailing arm. Avoid over-spraying other parts of the vehicle.

! WARNING

Undercoating is **extremely flammable!** Do **NOT** smoke and avoid any open flames during application to avoid possible injury. In addition, latex gloves and a dust mask should be worn to prevent skin contact with the undercoating or inhalation of any vapors.

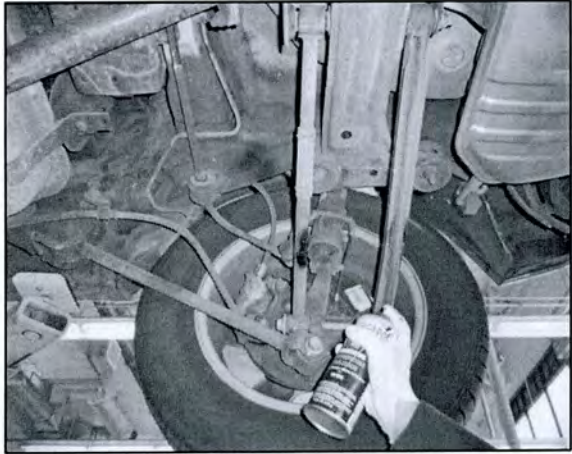

- 7. Apply undercoating onto the upper and lower surfaces of the cross member, as shown. Do **NOT** apply undercoating to the exhaust pipe or other unrelated parts of the vehicle.



SUBJECT:

APPLICATION OF ADDITIONAL ANTI-CORROSION
MATERIAL (SC104)

8. Apply undercoating onto all exposed surfaces of the fuel tank. Do NOT apply undercoating to the exhaust pipe or the fuel tank heat shield.

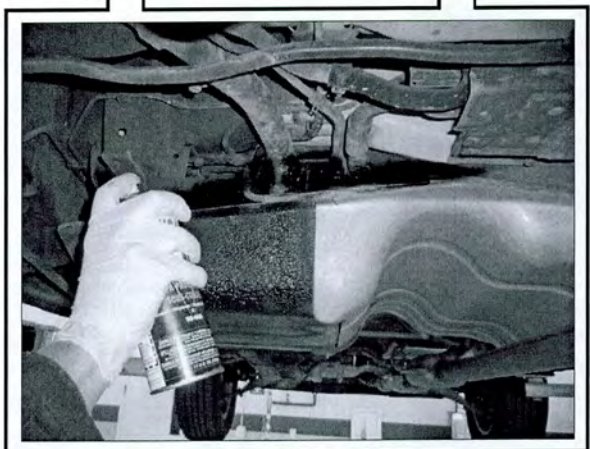
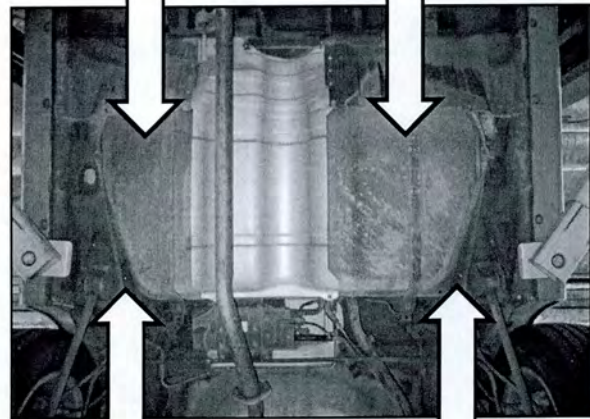
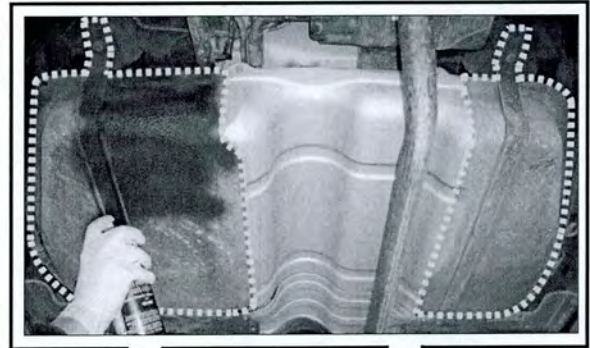



SUBJECT:

APPLICATION OF ADDITIONAL ANTI-CORROSION MATERIAL (SC104)

REQUIRED TOOLS:

Part Name	Part No.	Qty.	Figure	Comments
Wax Injection Gun	SC075 VGCRG	1		Used for applying cavity wax (order through Snap-on by calling (888) 542-1011)

REQUIRED PARTS:

Part Name	Part No.	Qty.	Figure	Comments
Cavity Wax	UM090 CH041	1		Limit one (1) can per vehicle (Order through Kia Chemicals)
Undercoating	UM010 CH044	3		Limit three (3) cans per vehicle (Order through Kia Chemicals)

AFFECTED VEHICLE PRODUCTION RANGE:

Model	Production Date Range
Sporage (KM)	From June 24, 2004 through January 26, 2010.

WARRANTY CLAIM INFORMATION:

Claim Type	Causal P/N	Qty.	N Code	C Code	Repair Description	Labor Op Code	Op Time	Replacement P/N	Qty.
R	54500 2E001	0	N56	C05	(SC104) Vehicle Underbody Wax & Undercoat Application	140013R1	0.7 M/H	UM090 CH041	1
								UM010 CH044	3

*** NOTICE**

To assure complete customer satisfaction, always remember to refer to WebDCS Warranty Coverage (validation) Inquiry Screen (Service > Warranty Coverage >Warranty Coverage Inquiry) for a list of any additional campaigns that may need to be performed on the vehicle before returning it to the customer.