

of 4.8.14

# SB-10055295-5974



Airbox Drainpipe Repair Kit  
Models: M.Y. '12-'13-'14 1199 and M.Y. '14 899 Panigale Panigale (all model versions)  
Service Bulletin SVC-14-010

Date: April 1, 2014  
To: Dealer Principal, General Manager, Service Manager, and Service Technician  
From: Austin Gray, Technical Director; Jonathan LaForte, Technical Manager

Dear Ducati Dealer,

### Situation

Regarding the above models, Ducati have received some isolated reports of minor oil leaks from the airbox bottom rubber drain tube near the clamp securing the tube to the union fitted on the crankcase. The leak is caused by damage to the tube.

For this reason, a repair kit has been created, part no.69927171A. This allows for repair of the leak without removing the airbox from the vehicle, making it no longer necessary to replace the airbox bottom for the repair operation.

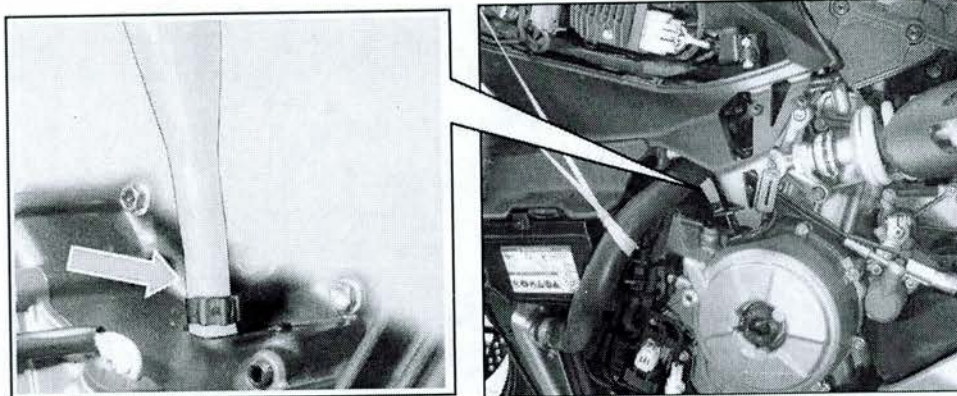

The airbox drain tube repair kit no. 69927171A is made of: a **spring clamp (1)**, a **cloth coated rubber pipe (2)**, a **male-male union (3)** and a **flat spring clamp (4)**.





Airbox Drainpipe Repair Kit  
Models: M.Y. '12-'13-'14 1199 and M.Y. '14 899 Panigale Panigale (all model versions)  
Service Bulletin SVC-14-010

### Service Solution

The procedure for kit no. 69927171A assembly is divided into the following sections:

- 1) Vehicle preparation;
- 2) Installation of airbox drain pipe repair kit no. 69927171A;
- 3) Restoring vehicle conditions.

#### 1) Vehicle preparation

- Remove the ignition switch cover - See section 05 of the Workshop Manual.
- Remove internal LH conveyor cover - See section 05 of the Workshop Manual.
- Remove side LH fairing - See section 05 of the Workshop Manual.
- Remove mono-shock cover assembly.
- Move radiator/thermostat **hose (A)**, towards motorbike front part, and keep it in its position by using **service rubber band (9)**.

Remove the **self-locking tie (5)** and slide **generator cable (B)** downwards for better access.

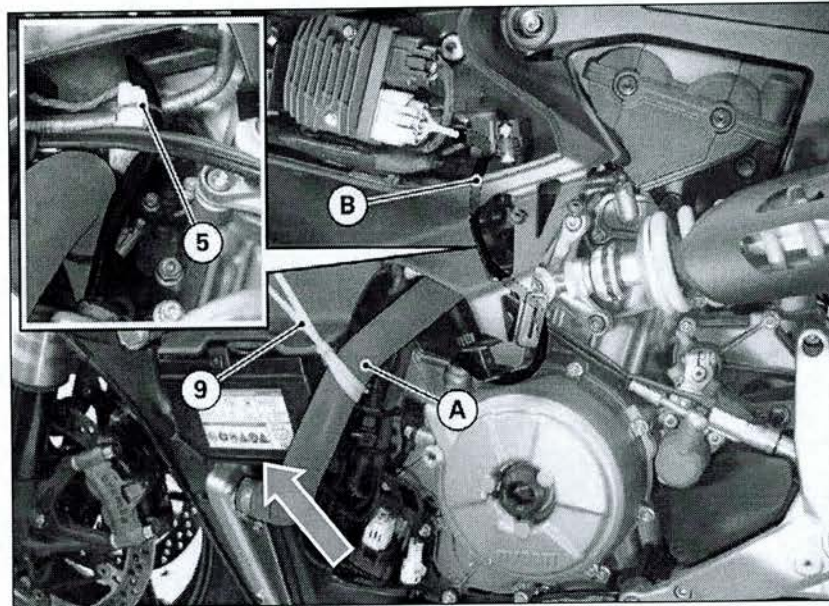



Airbox Drainpipe Repair Kit  
Models: M.Y. '12-'13-'14 1199 and M.Y. '14 899 Panigale Panigale (all model versions)  
Service Bulletin SVC-14-010

2) Airbox drain pipe repair kit no. 69927171A

- Fit **male-male union (3)** into **cloth covered rubber pipe (2)** from the smaller side.

Fit **spring clamp (1)** on **cloth covered rubber pipe (2)** up to pipe mid-height.

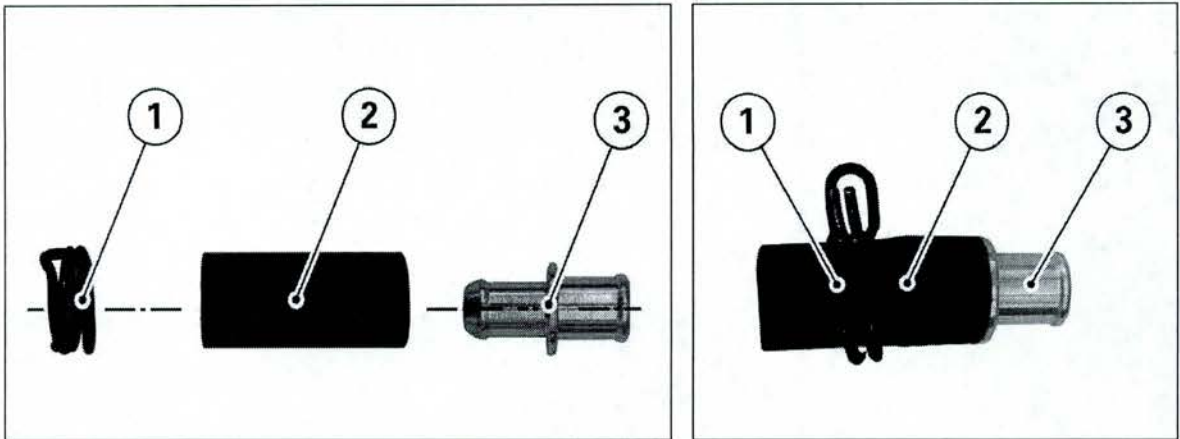

- Remove **clip (6)** and slide out **airbox bottom drain rubber pipe (7)** from the **union (10)** on crankcase.

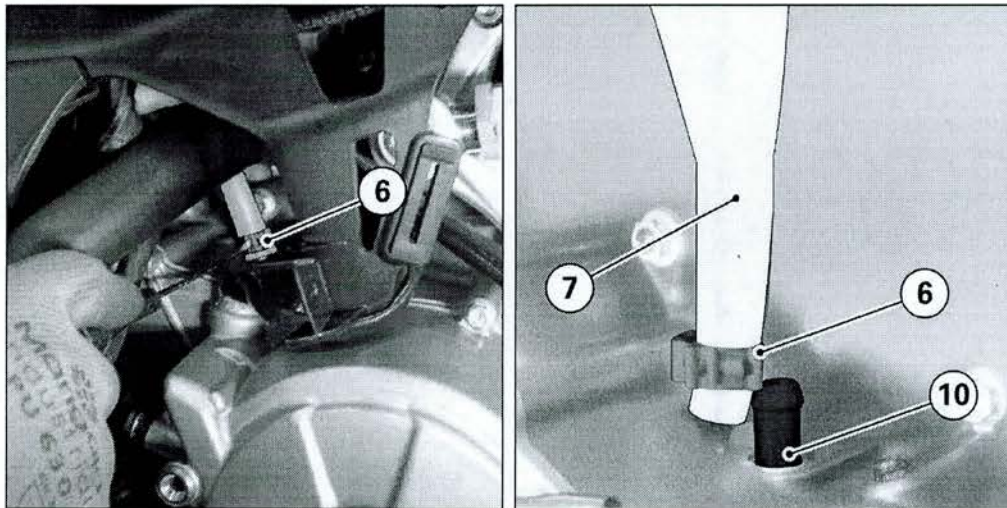



Airbox Drainpipe Repair Kit  
Models: M.Y. '12-'13-'14 1199 and M.Y. '14 899 Panigale Panigale (all model versions)  
Service Bulletin SVC-14-010

- Fit the **kit assembly (D)** (male-male union (3) + cloth covered rubber pipe (2) + black spring clamp (1)), into **union (10)** on crankcase, bringing it fully home on crankcase machined surface.

Secure the **cloth coated rubber pipe (2)** with **spring clamp (1)** with the end facing outwards.

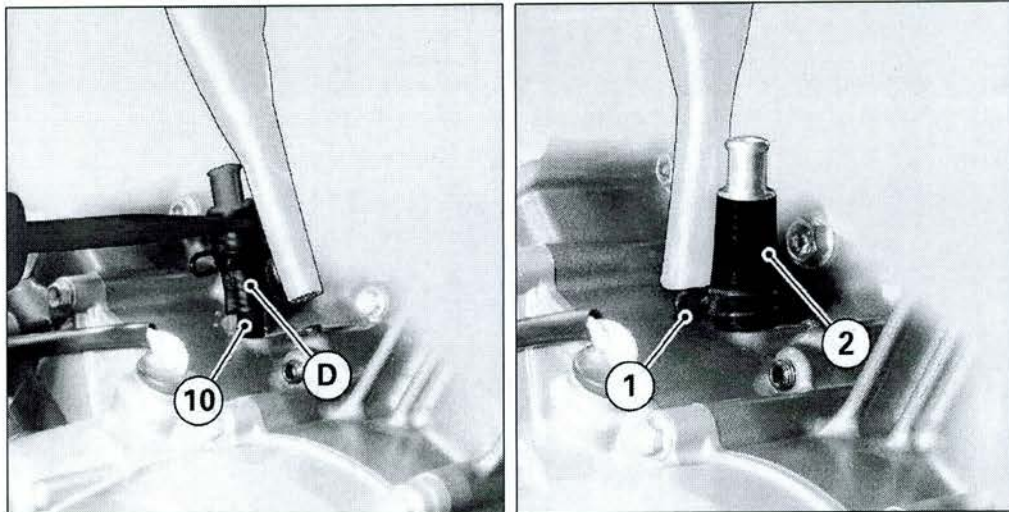

- Bring **airbox bottom drain rubber pipe (7)** close to **male-male union (3)**.

Cut **airbox bottom drain rubber pipe (7)** at the **male-male union (3)**, height so that it is possible to correctly fit it in the union.

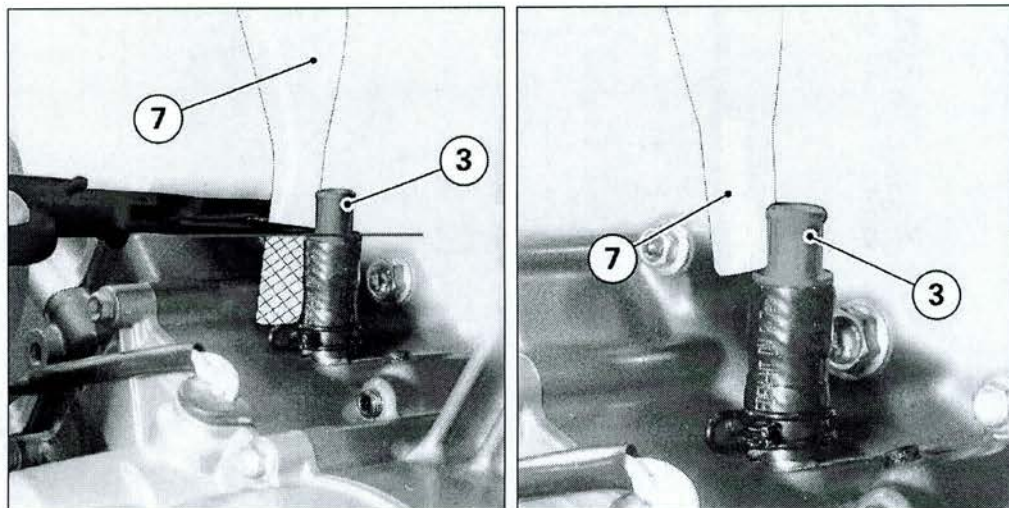



Airbox Drainpipe Repair Kit  
Models: M.Y. '12-'13-'14 1199 and M.Y. '14 899 Panigale Panigale (all model versions)  
Service Bulletin SVC-14-010

- Fit *flat spring clamp (4)* into *airbox bottom drain rubber tube (7)*.

Fit *CUT airbox bottom drain rubber pipe (7)* into *male-male union (3)*.

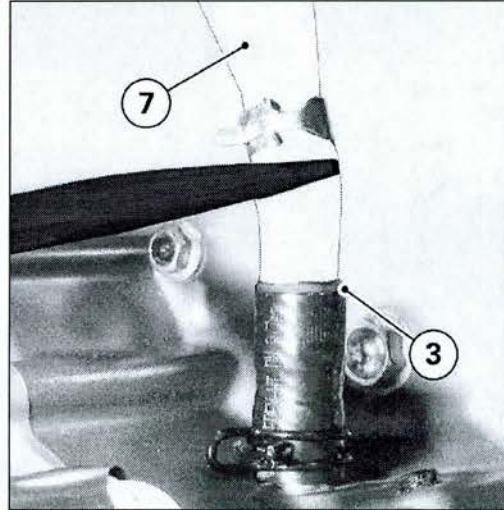
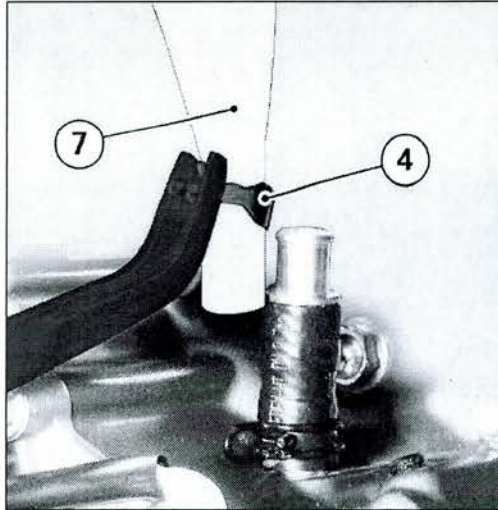

- Secure *CUT airbox bottom drain rubber pipe (7)* using *flat spring clamp (4)*; with the end facing outwards.

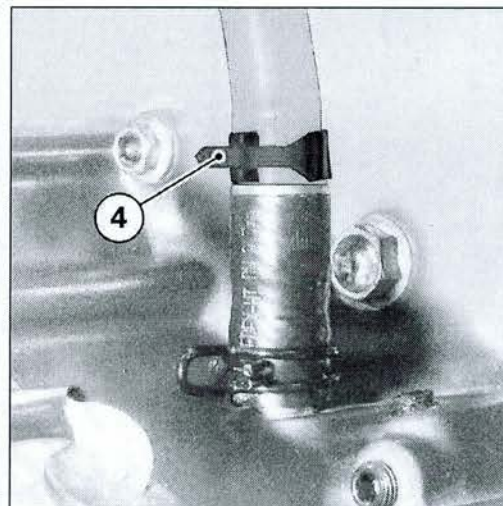
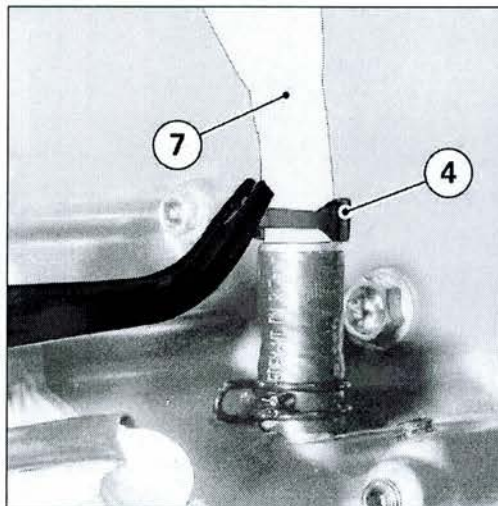



Airbox Drainpipe Repair Kit  
Models: M.Y. '12-'13-'14 1199 and M.Y. '14 899 Panigale Panigale (all model versions)  
Service Bulletin SVC-14-010

**3) Restoring vehicle condition**

- Reposition **generator cable (B)** and secure it with a **small self-locking tie (8)** in the position shown in the figure.

Remove the service rubber band and reposition **hose (A)**.

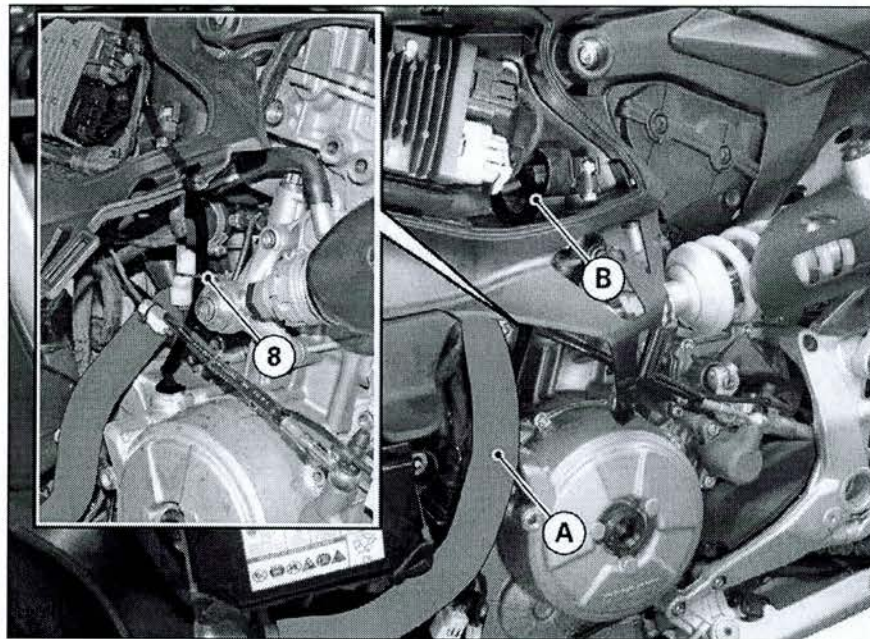

- Fit the **shock absorber (F) cover assembly**.

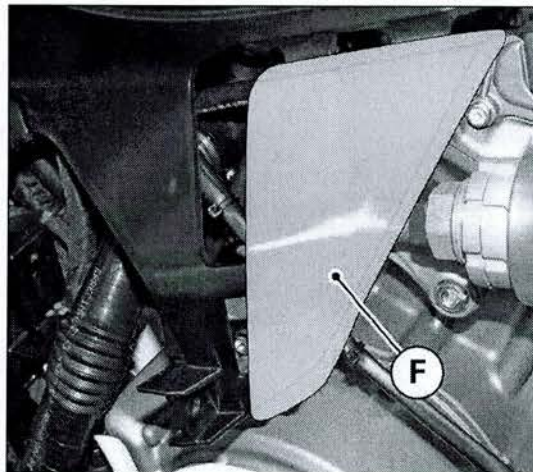



Airbox Drainpipe Repair Kit  
Models: M.Y. '12-'13-'14 1199 and M.Y. '14 899 Panigale Panigale (all model versions)  
Service Bulletin SVC-14-010

- Refit *side LH fairing (E)*, tightening the screws to the torque values shown in the figure.

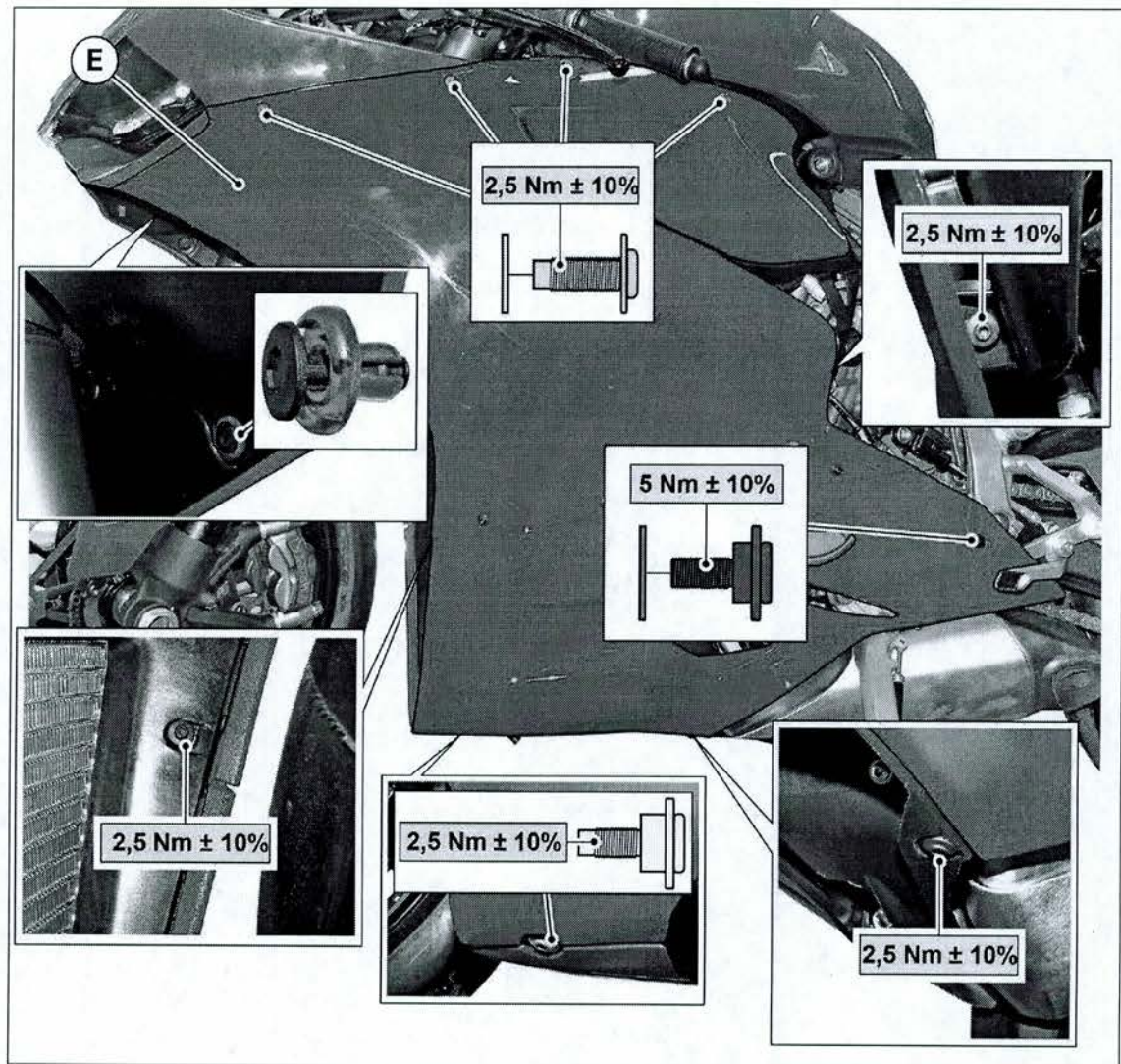

- Secure left conveyor cover - See section 05 of the Workshop Manual.
- Secure ignition switch cover - See section 05 of the Workshop Manual.



Airbox Drainpipe Repair Kit  
Models: M.Y. '12-'13-'14 1199 and M.Y. '14 899 Panigale Panigale (all model versions)  
Service Bulletin SVC-14-010

**Spare Parts**

The spare part KIT code for the update is **69927171A**.

**Warranty**

Labor time that will be reimbursed for the repair of the airbox drain pipe no. 69927171A is **60 minutes** (10LU); you can apply for a refund under warranty using following codes for labor:

Sub-group	2
Defect Code	2 - 051
Defect	G - OPERATION
Operation Code	2 - 999 - 096

We thank you in advance for your attention and cooperation.

Ducati North America  
Service Department