



SB-10054516-7501

SERVICE BULLETIN

Classification: AT13-009b	Reference: NTB14-002b	Date: August 15, 2014
------------------------------	--------------------------	--------------------------

2008-2012 ROGUE; REDUCED PERFORMANCE DUE TO CVT FLUID TEMPERATURE PROTECTION LOGIC

This bulletin has been amended to remove the pre-authorization check sheet and to add the procedure to check CVT temp count A/B. Please discard all previous versions.

APPLIED VEHICLE: 2008-2012 Rogue (S35) 2WD/4WD **without tow package kit**

IF YOU CONFIRM:

The vehicle speed is, or was, reduced by the CVT fail-safe (reduced vehicle speed) after continuous operation under the following conditions:

- High RPM and/or high speed driving (RPM of 4000+ or speeds of 65 mph [104.6 km/h] for 1.0 – 1.5 hrs. or more)
- Driving in ambient temperature of 96 degrees or higher
- Climbing steep or extended hills for 6 miles (9.6 km) or more
- Whine or rattle type noise occurring during reduced engine performance (vehicle speed decrease)

NOTE: Before applying this bulletin check and repair any DTCs first.

ACTION

1. Perform a self-diagnosis with CONSULT-III plus (C-III plus).
 - If DTCs are present, refer to the appropriate section of the Electronic Service Manual (ESM) and diagnose the DTCs first before proceeding to step 2 of **ACTION**.
2. Check the number of counts of "CVT-A" and "CVT-B" with C-III plus.
 - Refer to the Flow Chart on page 2 and the Service Procedure starting on page 3 to confirm if this bulletin applies.

IMPORTANT: The purpose of "ACTION" (above) is to give you a quick idea of the work you will be performing. You **MUST** closely follow the entire Service Procedure as it contains information that is essential to successfully completing the repair.

Nissan Bulletins are intended for use by qualified technicians, not 'do-it-yourselfers'. Qualified technicians are properly trained individuals who have the equipment, tools, safety instruction, and know-how to do a job properly and safely. **NOTE:** If you believe that a described condition may apply to a particular vehicle, **DO NOT** assume that it does. See your Nissan dealer to determine if this applies to your vehicle.

Flow Chart

Important

Before applying this bulletin:

- Confirm that the CVT fluid has not been overfilled and/or that a non-approved CVT fluid has been added.
- Confirm that the coolant concentration is not greater than 50%.
 - CVT fluid that is overfilled or non-approved, or coolant concentrations greater than 50% can cause the symptoms in the IF YOU CONFIRM section on page 1.

Refer to NTB12-057 to resolve these conditions first if they should occur.

NOTE: Refer to the ESM for the correct CVT fluid and coolant type for the model and year vehicle that is being worked on.

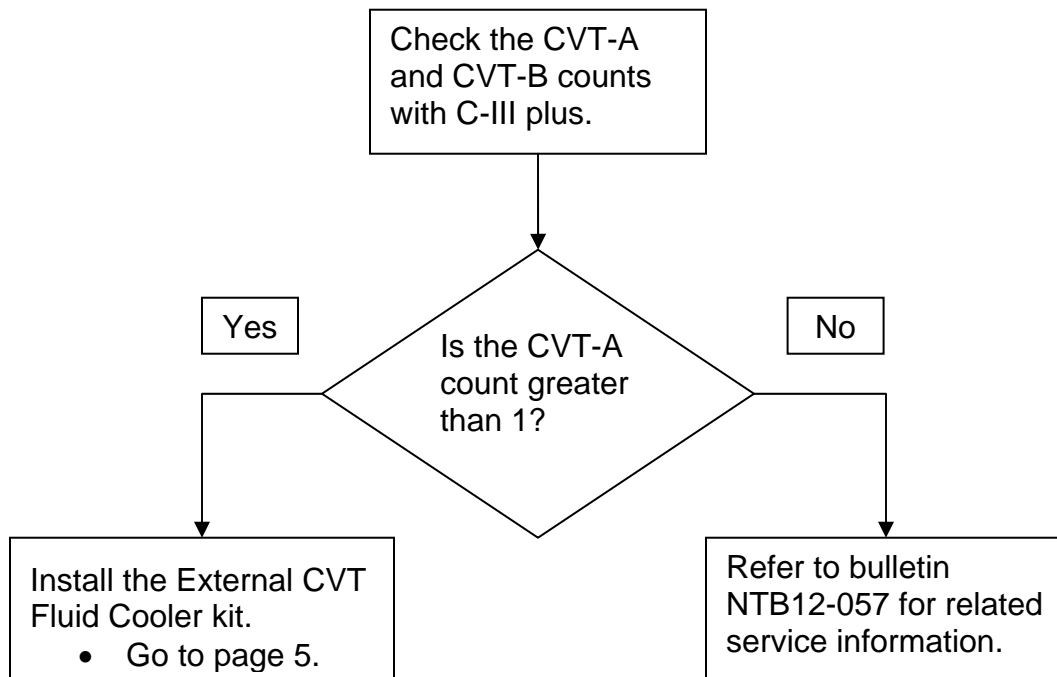

NOTE: If the CVT-A count is not greater than 1 and similar symptoms to those in IF YOU CONFIRM and/or a DTC are present, refer to the Electronic Service Manual (ESM) and NTB12-057 for further diagnosis.

SERVICE PROCEDURE

Check CVT-A and CVT-B count with C-III plus

1. Open C-III plus and select **Diagnosis (All Systems)**.

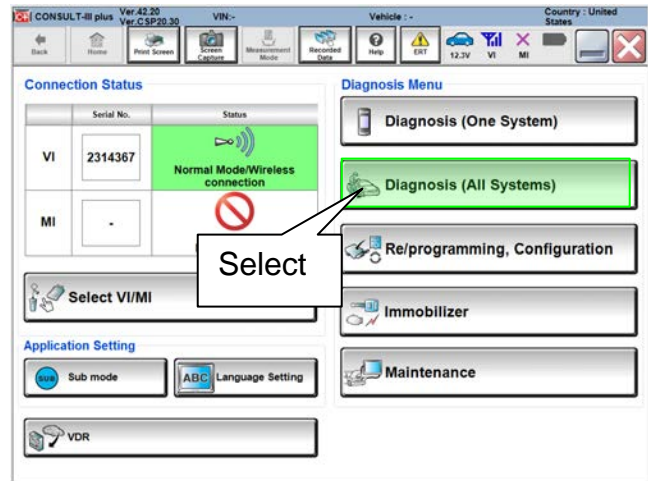

Figure 1

2. Select **TRANSMISSION**.

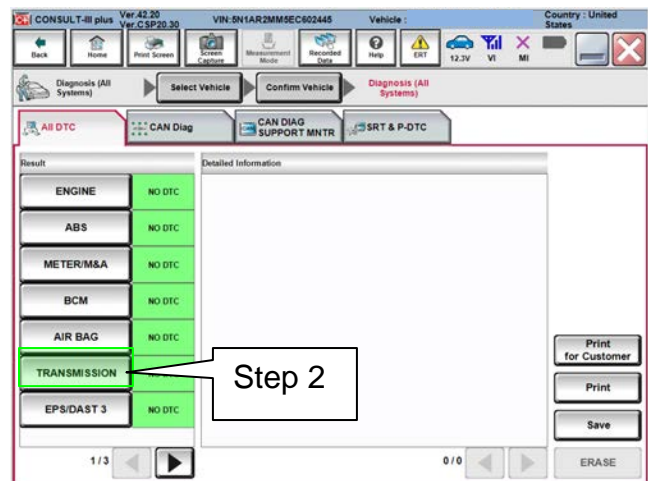

Figure 2

3. In **Data Monitor** select **TRANSMISSION** and then select **CVT-A** and **CVT-B**.

4. Select **START**.

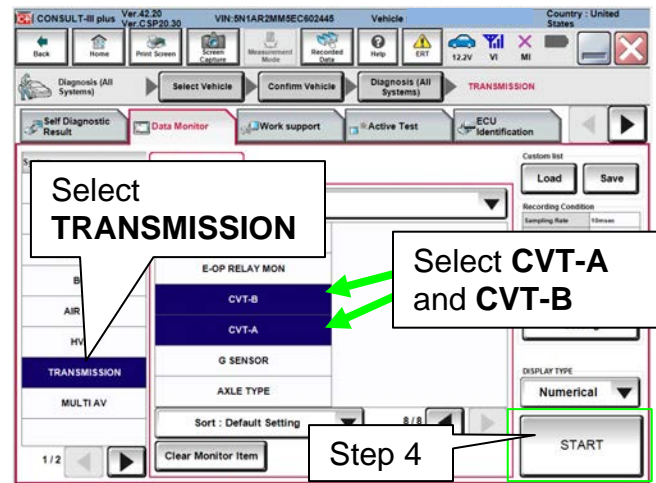

Figure 3

5. Check both **CVT-A** and **CVT-B** counts and refer to the Flow Chart on page 2 to confirm if this bulletin applies.

- Save this page to a file on the Consult PC for Step 6.

NOTE: If the CVT-A count is not greater than 1 and similar symptoms to those in IF YOU CONFIRM and/or a DTC are present, refer to the ESM and NTB12-057 for further diagnosis.

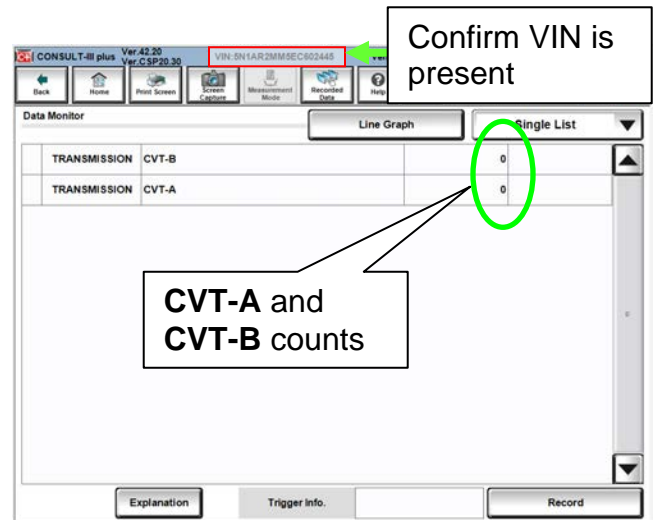

Figure 4

6. If it is confirmed that this bulletin applies, submit an order for the **SERVICE KIT** listed in the Parts Information table by sending an email with the screen print (Figure 4) from Step 5 to:

CVTOilCooler@nissan-usa.com

IMPORTANT: Please make sure the VIN number is clearly visible at the top of the screen print from Step 5 (Figure 4).

- Once DPIC has validated the order, a salesforce case will be generated for reference. You will receive a confirmation and the sales force case number to track the order status.
- Once the order is completed, you will receive a final confirmation of the order, including ETA of part arrival.

SERVICE PROCEDURE

Install Oil Cooler (CVT mounted heat exchanger with 4 ports)

1. Place the vehicle on a lift and raise it as needed to perform the following procedure.
2. Remove the front Bumper Fascia Assembly, front Under Cover, left front Fender Protector and left Air Guide.
 - Refer to the appropriate section of the FSM for the procedures to remove the items in step 2.

NOTE: The Air Guide is connected to the Radiator core support with a J-hook and must be lifted up before being pulled forward to remove.

3. Remove the Air Inlet Duct from the Air Cleaner Case.

WARNING: Never remove the radiator cap when the engine is hot. Serious burns may occur from high-pressure engine coolant escaping from the radiator.

4. Relieve any residual cooling system pressure.
 - a. Wrap a thick cloth around the radiator cap. Slowly turn it a quarter of a turn to release the pressure.
 - b. Then turn it all the way.
5. Clamp both of the coolant hoses attached to the CVT Fluid Cooler to prevent coolant loss.

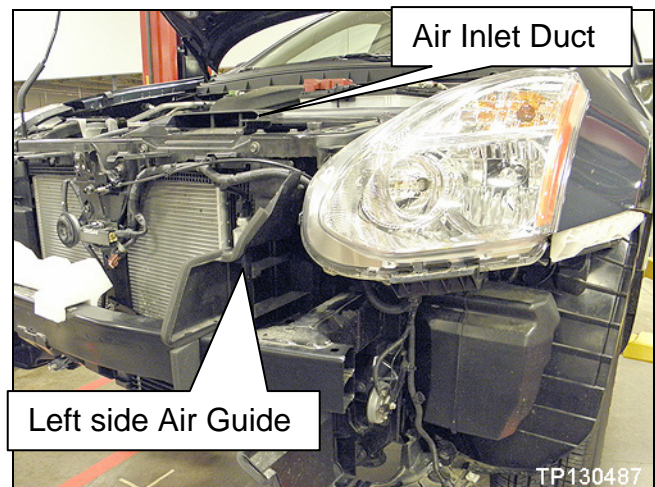

Figure 5

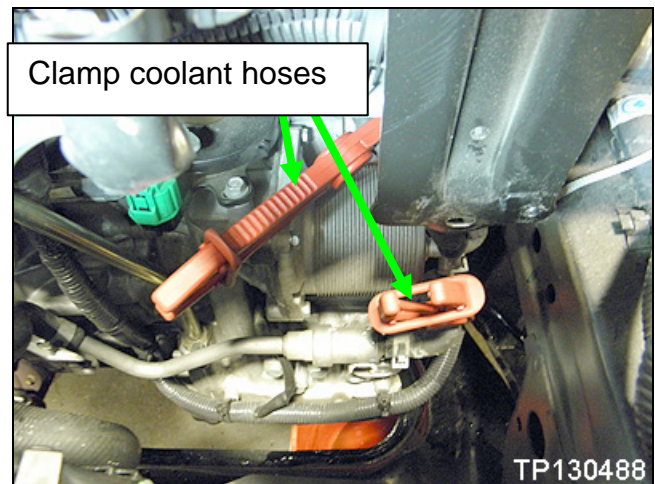

Figure 6

6. Remove "bolt A" and loosen "bolt B" for the Water Hose Bracket in Figure 7.

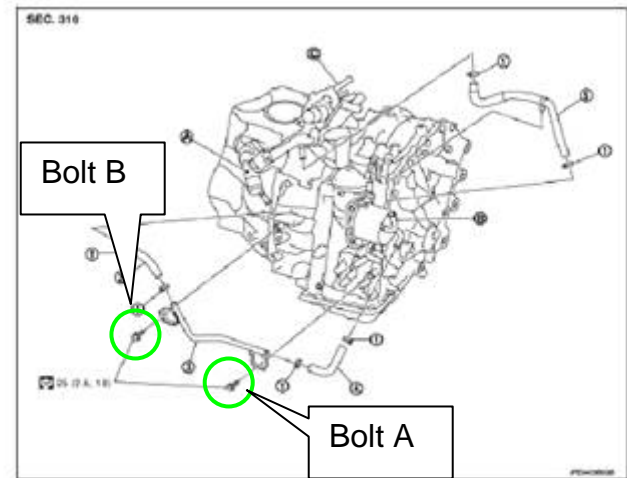

Figure 7

7. Remove the spring clamps from the CVT Fluid Cooler water hoses and then remove both hoses from the CVT Fluid Cooler.

NOTE: These spring clamps will be saved and reused for reassembly.

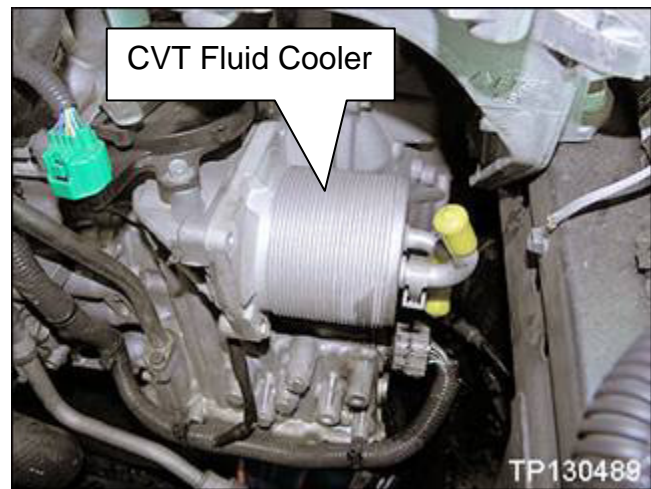

Figure 8

8. Remove the CVT Fluid Cooler mounting bolts and remove the CVT Fluid Cooler.
9. Clean any debris from the CVT Fluid Cooler mounting surface with brake cleaner and a lint free cloth.

NOTE: Use genuine Nissan Brake Cleaner or equivalent. Make sure the product that is used complies with local regulations.

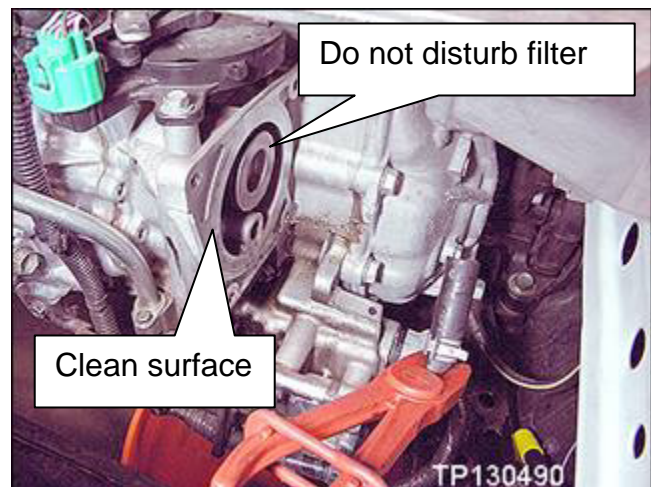

Figure 9

10. Coat the new O-ring on CVT Fluid Cooler using NS-2 CVT fluid before installing it onto the CVT Cooler mounting area.

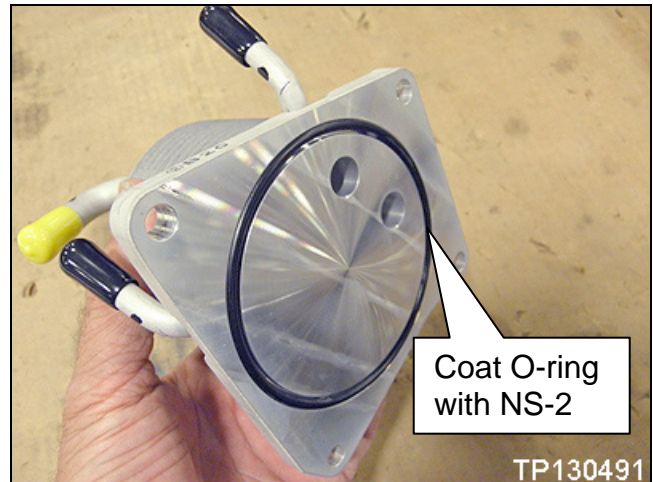

Figure 10

11. Install the new CVT Fluid Cooler from the kit onto the CVT and tighten the mounting bolts to 3.63 N•m (0.37 kg-m, **32 in-lb**).

12. Remove any residual coolant from the inside of both of the coolant hoses before re-assembly of the hoses to the CVT fluid cooler.

NOTE: Use genuine Nissan Brake Cleaner or equivalent. Make sure the product that is used complies with local regulations.

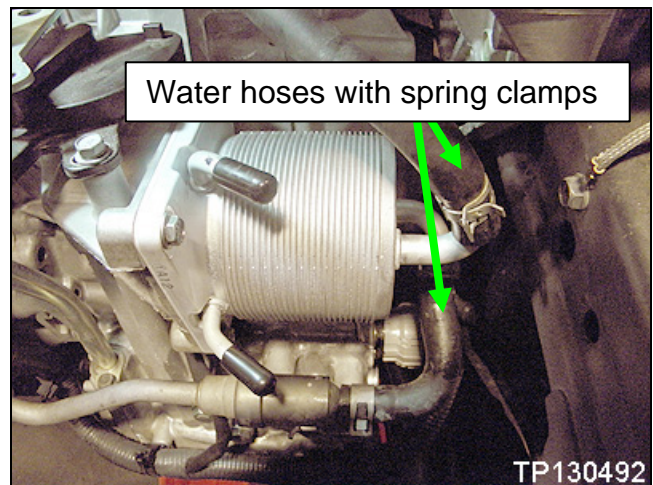

Figure 11

13. Re-install the water hoses onto the new CVT Fluid Cooler and then reinstall the spring clamps.

- Position the spring clamps as close to each fitting bulge as possible and then release them.

NOTE: Confirm that the clamps are not on top of each fitting bulge or on an angle.

14. Re-install the Water Hose Bracket and tighten bolt A and bolt B from step 6 to 4.2 N•m (0.43 kg-m, **37 in-lb**).

Install the COOLER ASSY-AUTO TRANS (external air-to-ATF CVT cooler)

1. Remove the SEAL-LOWER and create a notch to clear new BRKT ASSY-O/COOLER, LWR, and then re-install the SEAL-LOWER.
 - a. See Figure 14 for reference to locate the pre-existing weld nuts in the lower radiator support that the BRKT ASSY-O/COOLER, LWR (No. 3), shown in Figure 15 and Figure 16, will be attached to.
 - b. Place the BRKT ASSY-O/COOLER, LWR from the kit over the SEAL-LOWER and mark "bracket width" where the material will be removed as shown in Figure 12 and Figure 14.
 - c. Remove only enough material (Figure 13 and Figure 14) to allow the BRKT ASSY-O/COOLER, LWR to be installed to the lower radiator support (approximately 127mm x 50.8mm [5" x 2"]).
 - o Remove gently to avoid cracking the material.

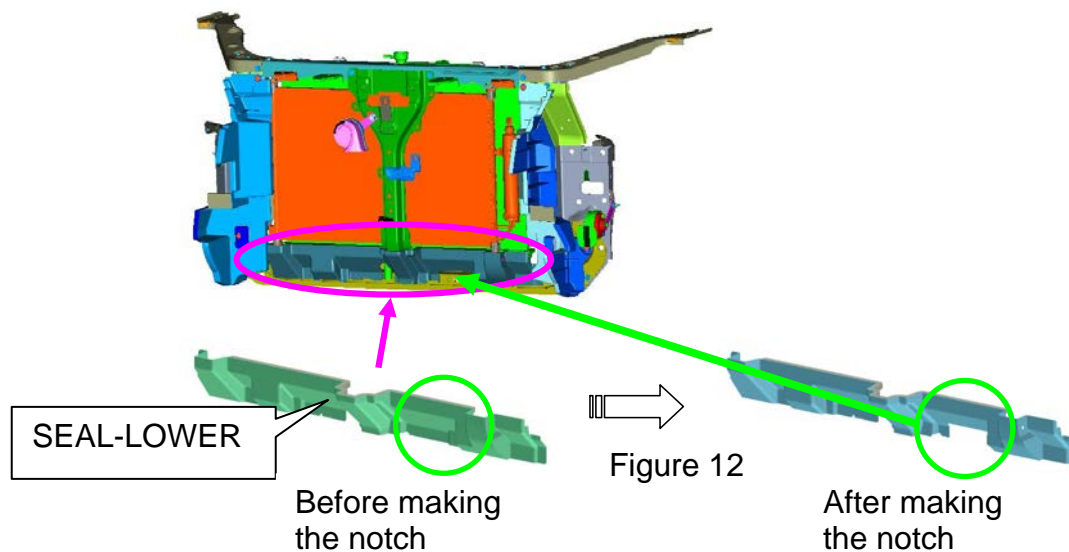

Figure 13

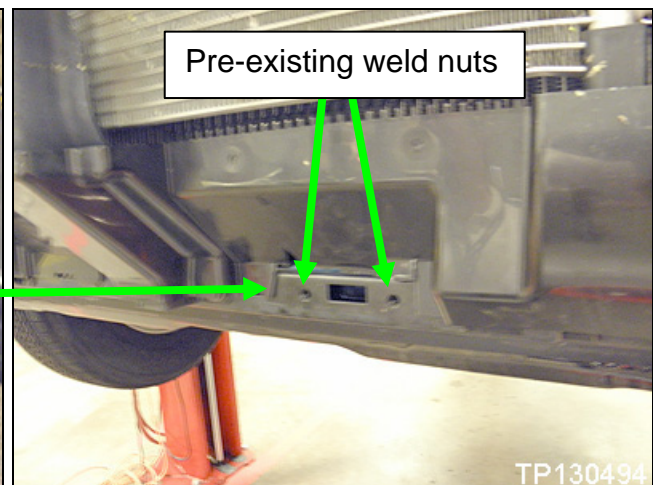

Figure 14

Figure 13 and Figure 14 illustrate the area to remove the material to allow clearance to install the BRKT ASSY-O/COOLER, LWR.

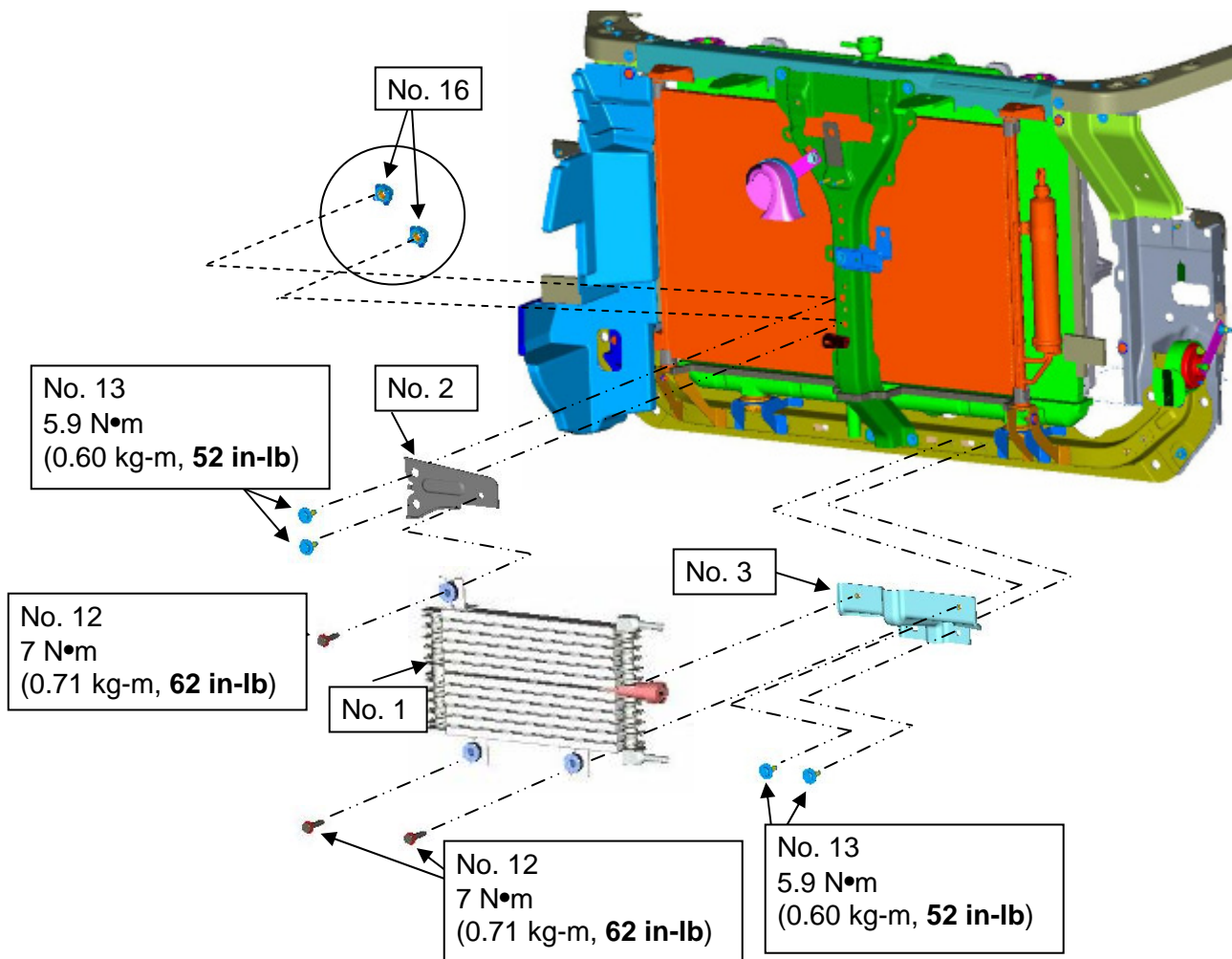

Figure 15

Figure 15 illustrates the COOLER ASSY-AUTO TRANS and attachment points to vehicle and is for reference when performing steps on page 10.

NOTE: Refer to Table A on page 16 for parts descriptions and quantities in the kit.

NOTE: Refer to Figure 15 on page 9 for steps 2-4 below.

2. Install BRKT ASSY-O/COOLER, LWR (No. 3) to the lower radiator support.

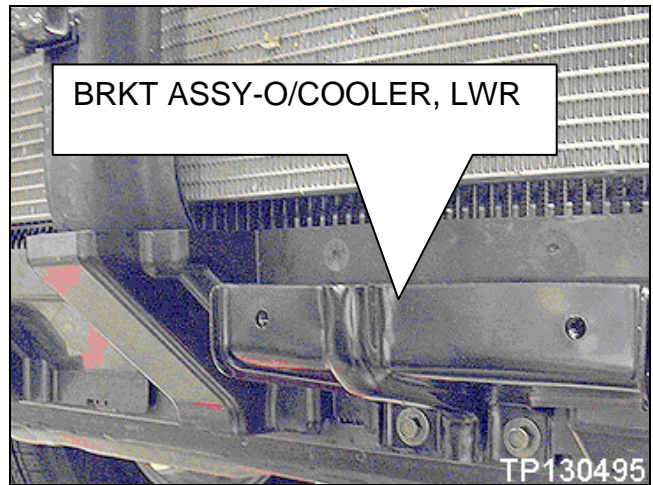

Figure 16

3. Install BRKT ASSY-O/COOLER, UPR (No. 2) to the center member.
 - Leave nuts loose at this time.

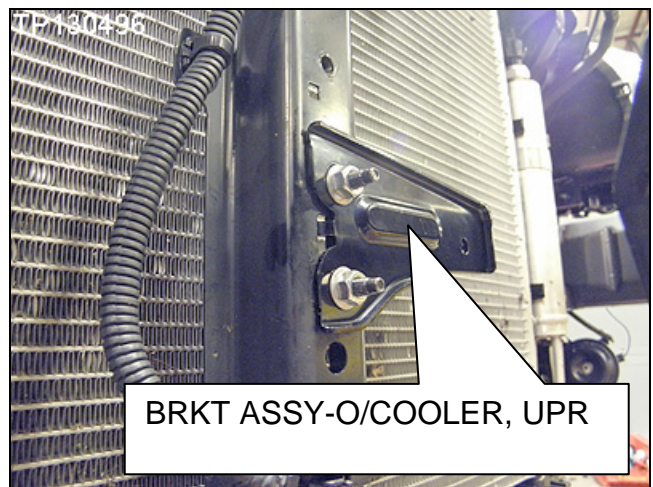

Figure 17

4. Install COOLER ASSY-AUTO TRANS, OIL (No. 1) and torque all bolts to specifications provided in Figure 15.

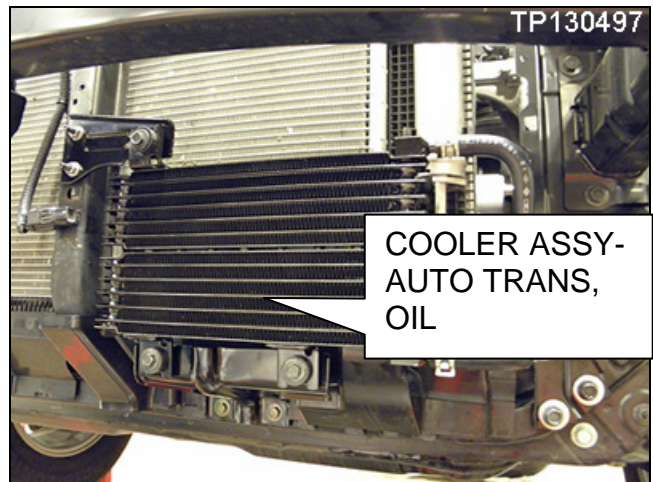

Figure 18

Assemble the Hoses and Side Bracket

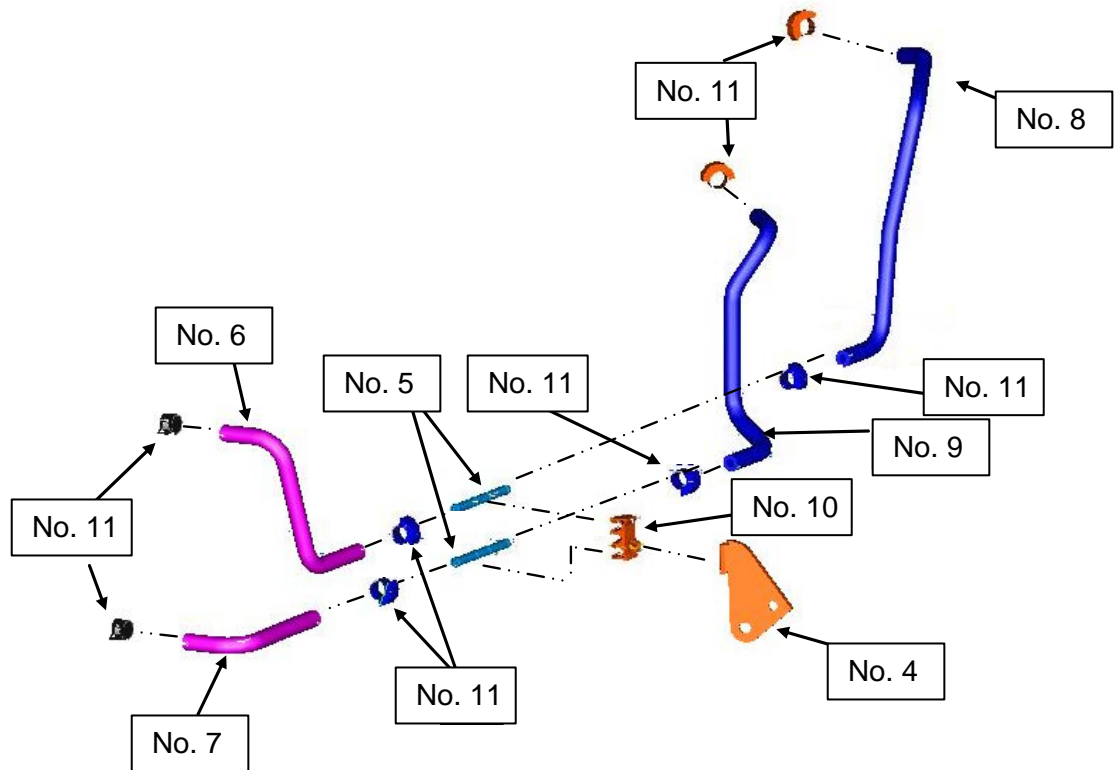

Figure 19

Figure 19 illustrates the COOLER ASSY-AUTO TRANS Hose Assembly referenced in steps 1-3 on page 12.

NOTE: Refer to Table A on page 16 for parts descriptions and quantities in the kit.

NOTE: Refer to Figure 19 on page 11 for steps 1-3 below.

1. Install hoses (No. 6/7/8/9) to TUBE-OIL COOLER (No. 5) with CLAMP-HOSE (spring clamp No. 11).

- Match the color marks on the hoses and rotate until the marks are aligned (Figure 20).
- Position the spring clamps as close to each fitting bulge as possible and then release them.

NOTE: Confirm that the clamps are not on top of a fitting bulge or on an angle.

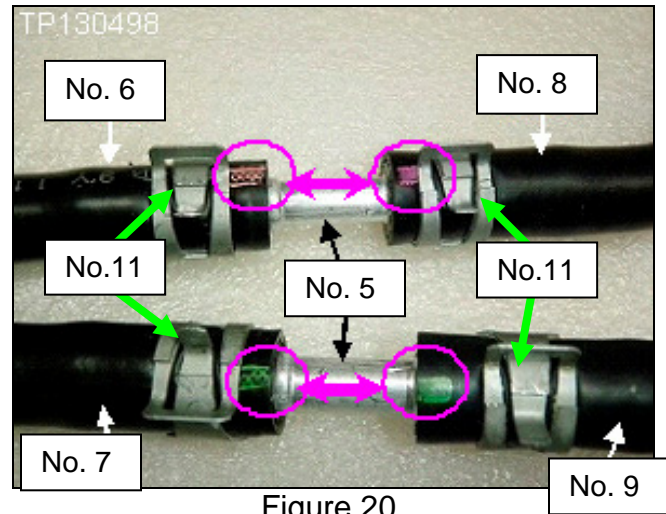

Figure 20

2. Install the CLIP-TUBE (No. 10) to the BRKT ASSY-O/COOLER, SIDE (No.4).

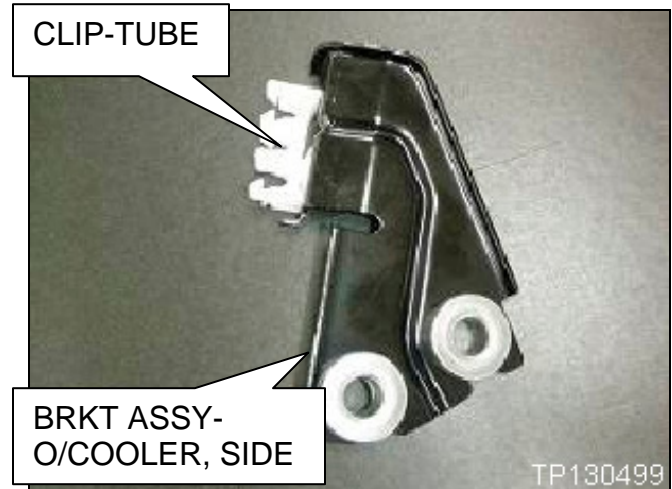

Figure 21

3. Assemble the Hoses to the Bracket.

- Install the pink color coded hose on the top and the green on the bottom of BRKT ASSY-O/COOLER, SIDE (No.4).

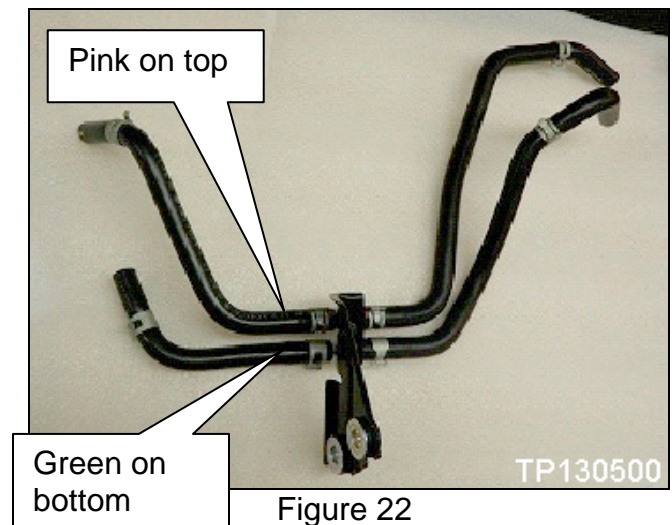

Figure 22

Install Hose and Bracket assemblies

NOTE: Refer to Figure 19 on page 11 and Figure 23 below for steps 1-3 below.

1. Install the assembled HOSE and BRKT onto the vehicle:
 - a. Pass the hoses shown in blue (Figure 23) between the radiator and the bulkhead.
 - b. Install BRKT ASSY-O/COOLER, SIDE (No. 4) with two bolts (No. 14) to the pre-existing weld nuts and torque with the specification provided in Figure 23.

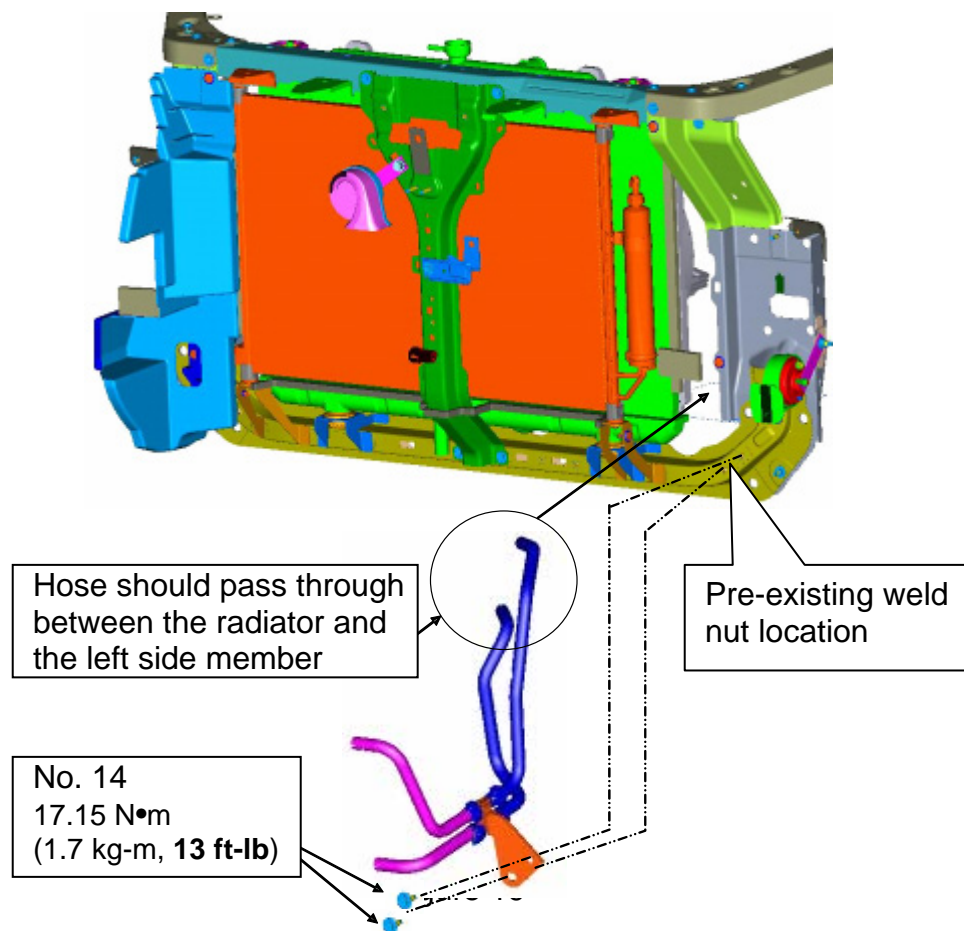

Figure 23

2. Place 2 new CLAMP-HOSE (spring clamp, No. 11) onto the hoses and install the HOSE (No. 6/7, Figure 19) onto COOLER ASSY-AUTO TRANS, OIL (No. 1) with the white paint marks facing toward front of the vehicle (Figure 24).

- Position the spring clamps as close to each fitting bulge as possible and then release them.

NOTE: Confirm that the clamps are not on top of a fitting bulge or on an angle.

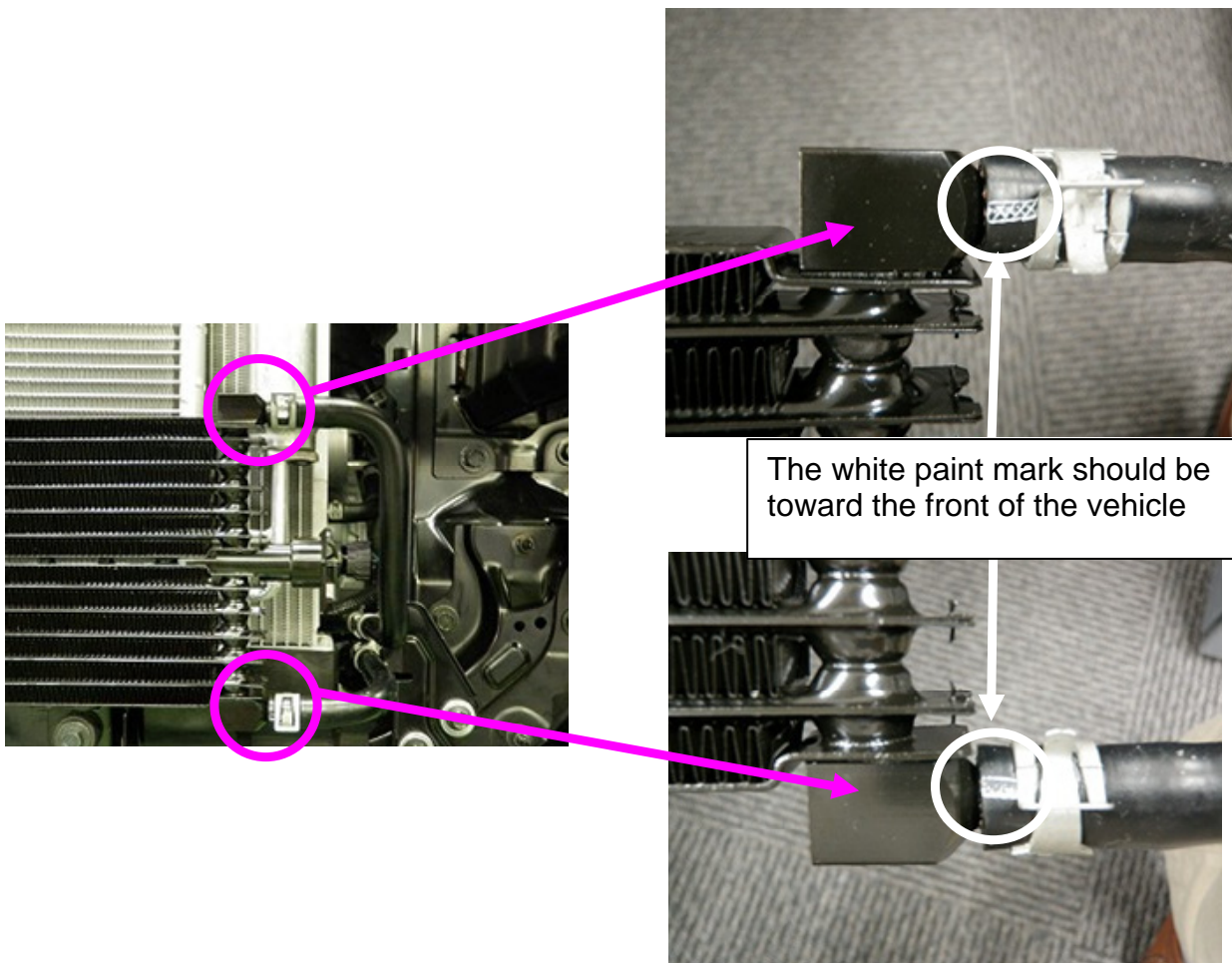

Figure 24

3. Place 2 new CLAMP-HOSE (spring clamp, No. 11) onto the hoses and install the cooler hoses (shown in blue, Figure 25) to the CVT Fluid Cooler.
 - Position the spring clamps as close to each fitting bulge as possible and then release them.

NOTE: Confirm that the clamps are not on top of a fitting bulge or on an angle.

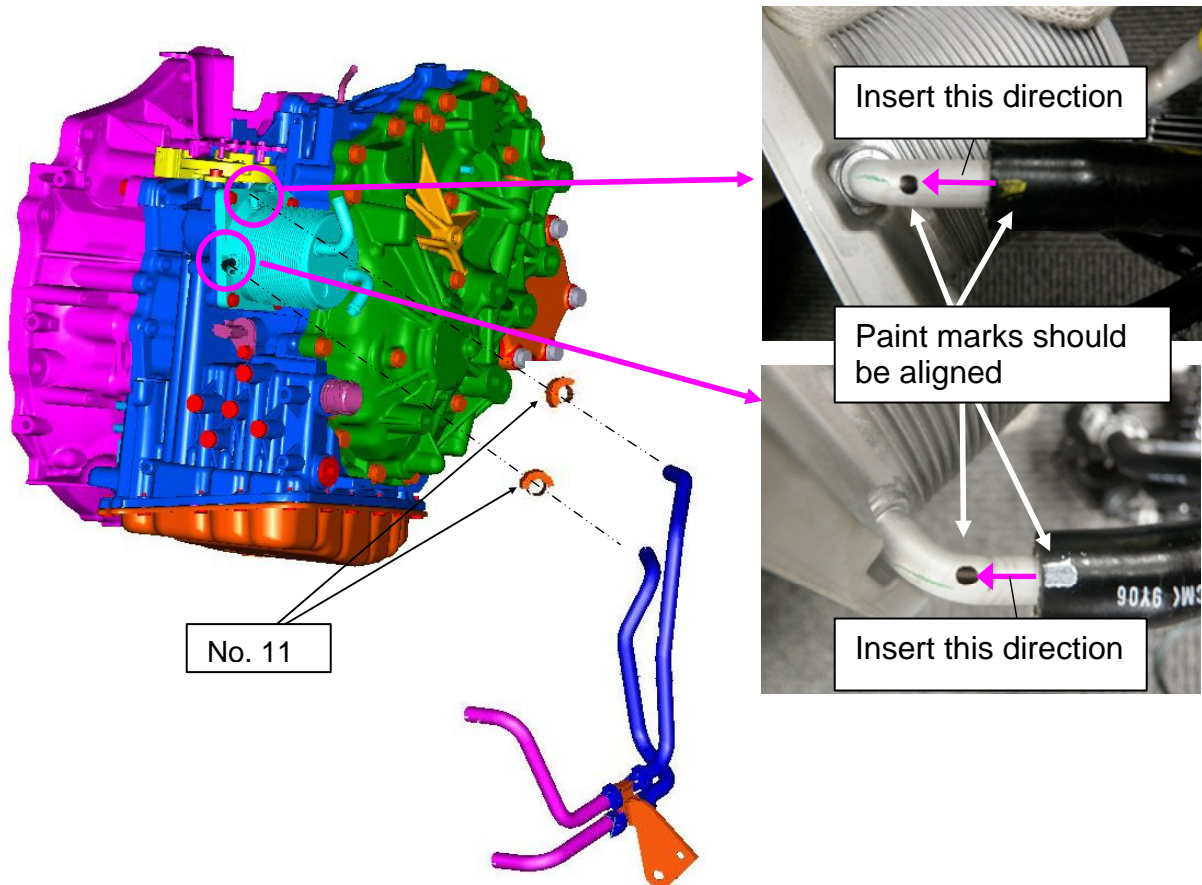

Figure 25

4. Re-install the front Bumper Fascia Assembly, front Under Cover, left front Fender Protector, left Air Guide, and the Air Inlet Duct in the reverse order.
5. Check the level of the coolant and add as needed.
 - Refer to ESM for correct coolant for the model year vehicle that is being worked on.
6. Check the level of the CVT NS-2 Fluid and add as needed.
 - Refer to ESM for correct method to check fluid level for the model year vehicle that is being worked on.

PARTS INFORMATION

DESCRIPTION	PART #	QUANTITY
SERVICE KIT-COOLER ASSY	B1606-JM01A	1
NS-2 CVT Fluid	999MP-NS200P*	As needed

* Order this item through the Nissan Maintenance Advantage program:
 Phone: 877-NIS-NMA1 (877-647-6621). Website order via link on dealer portal
www.NNAnet.com and click on the "Maintenance Advantage" link

Table A

INDEX	PART NAME	QTY PER KIT
1	COOLER ASSY-AUTO TRANS OIL (air-to-ATF cooler)	1
2	BRKT ASSY-O/COOLER, UPR	1
3	BRKT ASSY-O/COOLER, LWR	1
4	BRKT ASSY-O/COOLER, SIDE	1
5	TUBE-OIL COOLER	2
6	HOSE-AUTO TRANS, UPR	1
7	HOSE-AUTO TRANS, LWR	1
8	HOSE-AUTO TRANS, UPR (2)	1
9	HOSE-AUTO TRANS, LWR (2)	1
10	CLIP-TUBE (INSULATOR)	1
11	CLAMP-HOSE	8
12	BOLT-HEX,PP W/CON SPW	3
13	BOLT-HEX,PP W/CON SPW	4
14	BOLT-HEX,PP W/CON SPW	2
14a	NUT-HEX,PP W/CON SPW	2
16	NUT-HEX,PP W/CON SPW	2
18	OIL COOLER (CVT mounted heat exchanger with 4 ports)	1
19	OIL COOLER O-RING	1
20	Clip for lower seal	2

CLAIMS INFORMATION

Submit a Primary Part (PP) type line claim using the following claims coding:

DESCRIPTION	PFP	OP CODE	SYM	DIA	FRT
Oil cooler kit installation	(1)	JX15AA	AE	32	1.5

(1) Refer to the electronic parts catalog (FAST) and use the Oil Cooler assembly part number (21606 -*****) as the Primary Failed Part (PFP).