



Program Bulletin

CUSTOMER SATISFACTION PROGRAM

SUBJECT: Front Strut - Noise

MODELS: 2012-2013 Chevrolet Colorado
2013 Chevrolet Trailblazer

CONDITION

On some 2012-2013 model year Chevrolet Colorado/Trailblazer vehicles, squeaking or creaking noise may be heard from the front suspension during driving.

CORRECTION

Change the Spring Seat Isolator (Improved part – Part no 52057793) and BUMPER, FRT S/ABS UPR (LOWER) (Improved part – Part no 92272819) and other damaged part as necessary.

VEHICLES INVOLVED

All involved vehicles are identified by Vehicle Identification Number on the Investigate Vehicle History screen in GM Global Warranty Management system. Dealership service personnel should always check this site to confirm vehicle involvement prior to beginning any required inspections and/or repairs. It is important to routinely use this tool to verify eligibility because not all similar vehicles may be involved regardless of description or option content.

For dealers with involved vehicles, a listing with involved vehicles containing the complete vehicle identification number, customer name, and address information has been prepared and will be provided to dealers through the GM GlobalConnect Recall Reports, or sent directly to export dealers. Dealers will not have a report available if they have no involved vehicles currently assigned.

The listing may contain customer names and addresses obtained from Motor Vehicle Registration Records. The use of such motor vehicle registration data for any purpose other than follow-up necessary to complete this program is a violation of law in several states/provinces/countries. Accordingly, you are urged to limit the use of this report to the follow-up necessary to complete this program.

PART INFORMATION

Parts required to complete this program are to be obtained from General Motors Customer Care and Aftersales (GMCC&A). Please refer to your “involved vehicles listing” before ordering parts. Normal orders should be placed on a DRO = Daily Replenishment Order. In an emergency situation, parts should be ordered on a CSO = Customer Special Order.

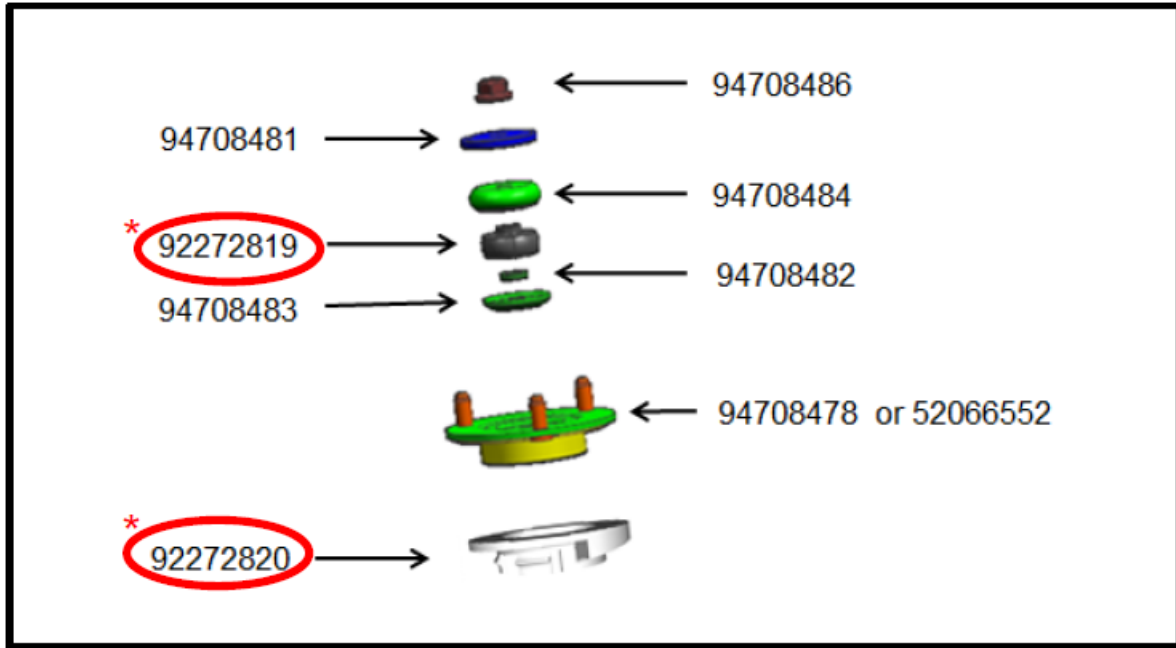

Improved part – Change all of the affected VINs

Item	Part No	Quantity	Remark
Spring Seat Isolator (Improved part)	52057793	2	Replace all VINs
BUMPER, FRT S/ABS UPR ((LOWER) (Improved part)	92272819	2	Replace all VINs

Part information – Change as necessary







Item	Part No	Quantity	Remark
MOUNT, FRT S/ABS UPR (W/O INSULATOR, FRT SPR UPR 92272820)	52066552	2	Replace if damaged
NUT, FRT S/ABS	94708486	2	Replace if damaged
BUMPER, FRT S/ABS UPR ((UPPER)	94708484	2	Replace if damaged
SHER, FRT S/ABS	94708483	2	Replace if worn more than 1mm
WASHER, FRT S/ABS (UPR)	94708482	2	Replace if worn more than 1mm
ABSORBER, FRT SHK	Based on vehicle options	2	Replace if worn more than 1mm
WASHER, FRT S/ABS UPR BRKT	94708481	2	Replace if damaged

Remark:

P/N 94708478: Top mount bracket with Spring Seat Isolator - Old part number

P/N 52066552: Top Mount Bracket without Spring Seat Isolator – New Part number

Service Parts Identification

<p>1. INSULATOR, FRT SPR UPR (Supplier: ZF BOGE) P/N 92272820</p> <p>Not required for this field action</p> 	<p>4. SPRING, FRT: P/N 9472400</p>  <p>Yellow Blue/Blue</p>	<p>Vehicle option AT/MT 4WD full</p>
<p>2. BUMPER, FRT S/ABS UPR (LOWER) P/N 92272819</p> 	<p>P/N 94751368 -</p>  <p>Yellow Blue/Yellow</p>	<p>T 2WD</p>
<p>3. INSULATOR, FRT SPR UPR (Supplier: BASF) P/N 52057793</p>  	<p>P/N 94751369 -</p>  <p>Yellow Blue/Green/</p>	<p>T 4WD full, 2.5D 2WD</p>

Not required for this field action

SERVICE PROCEDURE

1. Check the Customer VIN with the affected VIN list in order to replace parts based on the recommended instruction.
2. Identify and/or confirm that the complaint noise is a squeaking noise from the front suspension while driving.
3. Remove both front struts (even if there is only a noise from one side).

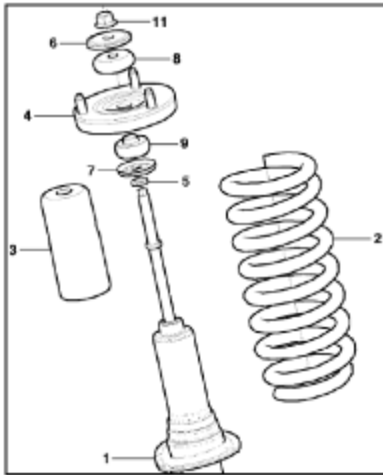

Figure 1

4. Before removing the top mount bracket (refer figure 1, item 4), place alignment marks on the top mount bracket and spring using the outboard mounting bolt on the strut top bracket as a reference. Mark the bottom of the spring to shock absorber as well. These marks should all be aligned as shown in figure 2 and 3.

Warning: Follow ALL procedures for Removal found in SI. Spring is under tension and could cause injury if not removed in accordance with all instructions.



Figure 2 – Top plate marking



Figure 3 – Shocker absorber assembly

5. Remove the top mount plate. Ensure SI procedures are followed as the spring is under tension and injury could occur if incorrectly disassembled.

6. Refer to figure 1 - the lower bush (9) will be replaced as well as the spring seat insulator (not shown in figure 1). In addition, inspect the top mount bracket (4), cup washer (7), upper bush (8), and shock absorber rod (1) for damage. Follow these guidelines to determine if these parts should be replaced:

- Place a straight edge along the shock absorber rod as shown in figure 4.
- Measure the depth of wear on the shaft. If the wear is greater than 1mm, replace the shock absorber.

- Inspect the steel washer (silver) that is pressed into the centre of the top mount bracket. If the washer has worn through to the black steel mount bracket, then replace the top mount bracket, refer figure 5.
- Inspect the upper bush (8), if the bush is out of shape or is damaged, replace the bush. In most cases it is expected that the upper bush can be reused. Do not replace it unless necessary.
- Inspect the cup washer (7) for distortion or other damage. Replace only if required.

Figure 4 — Measure Gap between Straight Edge and Shock Rod

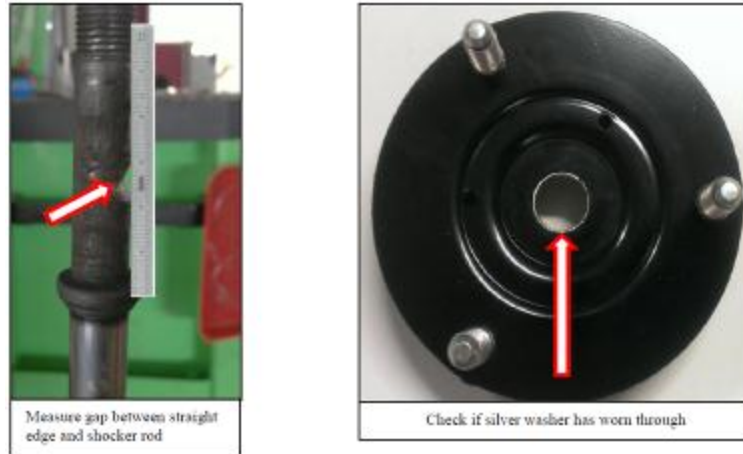

Figure 5 — Check if Silver Washer Has Worn Through

7. Install the revised spring seat insulator (52057793) to the top of the spring. The revised insulator has a step or recess in it for the end spring coil to sit in. Ensure the spring sits fully into the step/recess, refer figure 6 & 7.

Phase II :



Figure 6



Figure 7

8. Install the revised top mount lower bush part number 92272819 to the strut top bracket. Ensure the inner lip of the bush is not pinched or folded when installing. Refer figure 8.



Figure 8

9. In case of Trailblazer front spring doesn't have yellow dot mark must be change spring improvement (with yellow). Install the top mount assembly into the rubber insulator taking care to align the paint marks, refer figure 9 & 10.

Phase II: Please refer to the affected VIN list (Trailblazer Build range: SORP – 25 Apr 2013 / 8,475 Units)



Figure 9



Figure 10

Phase II:



Figure 9

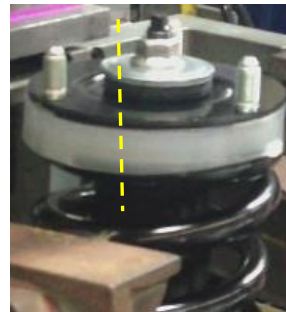

Figure 10

10. Reassemble the strut assemblies following SI procedures. Ensure the spring is aligned and fully seat at the bottom.

11. Test and confirm the noise is eliminated.

WARRANTY INFORMATION

Submit a transaction using the table below

Labour code	Description	Labour Time
9100379	A140040 GMI700&31UX C Front Strut Noise MY12-13_Inspection	0.1
9100378	A140040 GMI700&31UX C Front Strut Noise MY12-13 Replace Insulator (White Color), Lower Bushing and others (If damaged)	1.6

*In case of customer did the modification on a shock absorber or replace a new shock absorber, Labour operation code 9100379 will be applied for this case to close a job card.

DEALER PROGRAM RESPONSIBILITY

All unsold new vehicles in dealers possession and subject to this program must be held and inspected/repared per the service procedure of this program bulletin before customers take possession of these vehicles.

Dealers are to contact affected vehicle owners for them to bring their vehicles into service centers to have this issue corrected at no charge to customers, regardless of mileage, age of vehicle, or ownership.

Customers who have recently purchased vehicles sold from your vehicle inventory, and for which there is no customer information indicated on the involved vehicle listing, are to be contacted by the dealer. Arrangements are to be made to make the required correction according to the instructions contained in this bulletin.

In summary, whenever a vehicle subject to this program enters your vehicle inventory, or is in your facility for service, you must take the steps necessary to be sure the program correction has been made before selling or releasing the vehicle.

DD MM 2014

Dear Chevrolet Customer,

This notice is sent to inform you that Chevrolet is conducting a customer satisfaction program on certain MY 2012/2013 Chevrolet Colorado and Trailblazer vehicles.

We have learned that on some involved vehicles, a squeaking or creaking noise may be heard from the front suspension during driving.

Your satisfaction is very important to us. We therefore, would like to announce this program to prevent this condition or, if it has occurred, to fix it.

According to our records, you own a vehicle which is subjected to this customer satisfaction program. We hereby request you to visit your nearby authorized dealer and/or service center to have your vehicle immediately inspected for the Front shock absorber condition and correction.

Please contact your authorized dealer and/or service center to schedule an appointment for this program. Service instructions have already been sent to your authorized dealer and/or service center and this service can be completed in 2 hours under service appointment.

If you have any questions or concerns, please feel free to contact your Chevrolet Customer Relations Department at -----.

We apologize for inconvenience.

Sincerely,

bulletins are intended for use by professional technicians, NOT a "do-it-yourselfer". They are written to inform these technicians of conditions that may occur on some vehicles, or to provide information that could assist in the proper service of a vehicle. Properly trained technicians have the tools, equipment, safety instructions, and know-how to do a job properly and safely. If a condition is described, **DO NOT** assume that the bulletin applies to your vehicle, or that your vehicle will have that condition. See your dealer for information on whether your vehicle may benefit from the information.