

# Immobilizer and Smart Key Reset

Service  
Category Vehicle Interior

Section Theft Deterrent/Keyless Entry

Market USA

Scion Supports  
ASE Certification 

## Applicability

YEAR(S)	MODEL(S)	ADDITIONAL INFORMATION
2004 – 2015	FR-S, iQ, iQ EV, tC, xA, xB, xD	

### REVISION NOTICE

July 25, 2014 Rev1:

- Sections 1, 2, and 3 have been updated.

Any previous printed versions of this bulletin should be discarded.

## Introduction

The Immobilizer and Smart Key Reset is a feature that allows the registration of new keys when all master keys are lost. Once the system is reset, all previously registered keys will be erased. Follow the procedures in this bulletin to reset a vehicle Immobilizer or Smart Key system.

### NOTE

There are new security provisions required to obtain a Reset Pass-Code. It is critical that the instructions for this new process are reviewed BEFORE attempting to get a Pass-Code in the new system.

## Warranty Information

OP CODE	DESCRIPTION	TIME	OFF	T1	T2
N/A	Not Applicable to Warranty	-	-	-	-

## Immobilizer and Smart Key Reset

---

### Required Tools & Equipment

REQUIRED EQUIPMENT	SUPPLIER	PART NUMBER	QTY
Techstream 2.0*	ADE	TS2UNIT	1
Techstream Lite		TSLITEPDLR01	

\* Essential SST.

#### NOTE

- Only **ONE** of the Techstream units listed above is required.
- Software version 9.10.037 or later is required.
- Additional Techstream units may be ordered by calling Approved Dealer Equipment (ADE) at 1-800-368-6787.

### Service Bulletin Overview

1. Review the vehicle application chart in the Technical Information System (TIS) to verify the vehicle is capable of being reset.  
  
Refer to the *Toyota / Scion Vehicle Support* chart located on TIS, under *Diagnostics – Immobilizer Reset – Reference Documents*.
2. Review the new security authorization process and chose the option that best supports your dealer situation.
3. Follow the Techstream and TIS screenshots to obtain the Pass-Code needed to open registration for Immobilizer and Smart Key programming.

#### NOTE

Some early ECM based Immobilizers cannot be reset using Techstream. For these vehicles, do the following:

- Identify the vehicle using the *Toyota / Scion Vehicle Support* chart noted above.
- Refer to the most recent PANT bulletin for instructions.

# Immobilizer and Smart Key Reset

## Section 1: Security Authorization for the Reset Pass-Code

An improved security measure has been implemented in TIS that requires a secondary approval by dealer management each time an Immobilizer or Smart Key Reset request is submitted. Please review the following flow chart and become familiar with the options outlined prior to attempting a vehicle reset.

Figure 1. Immobilizer Reset Process

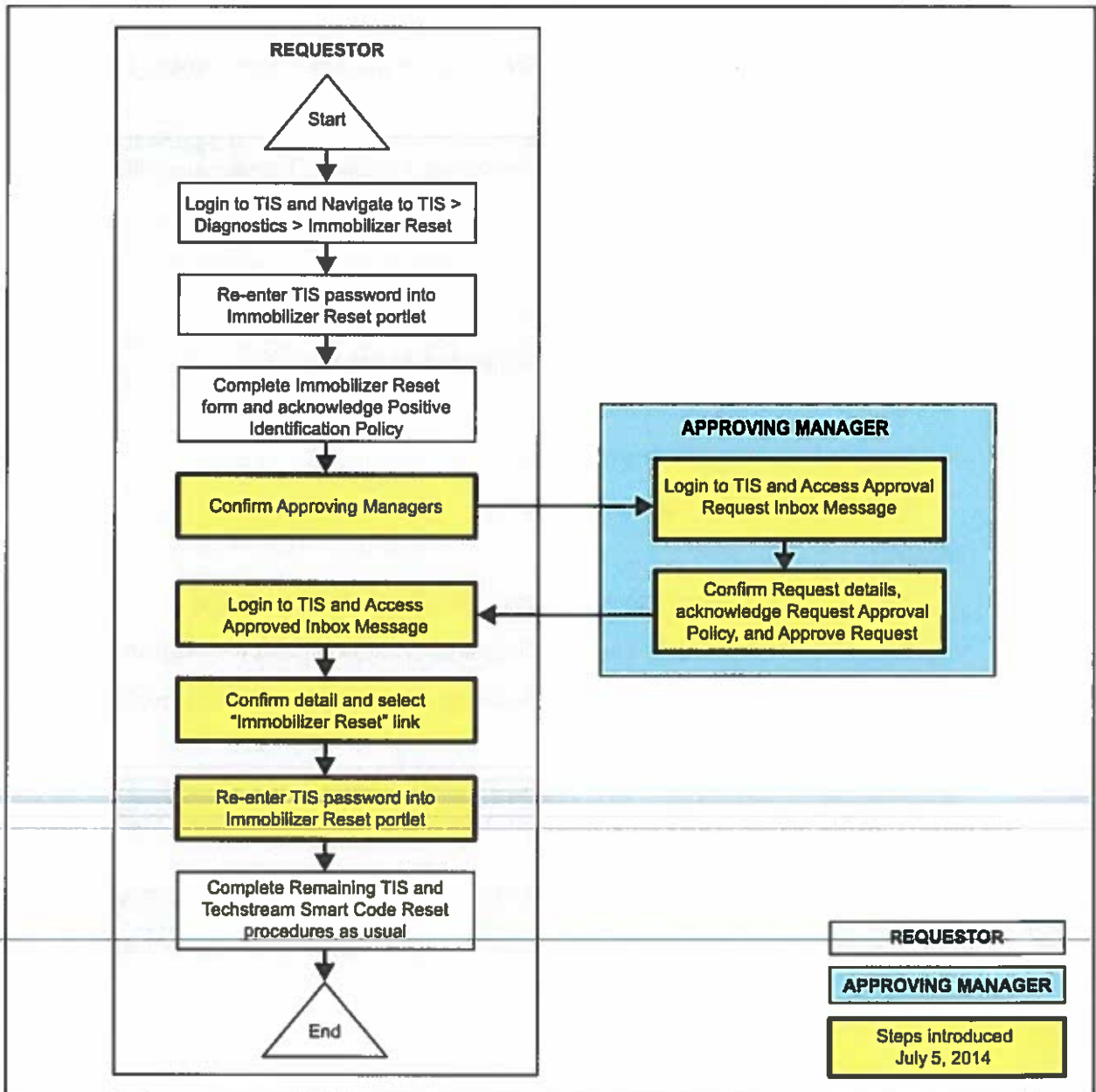

## Immobilizer and Smart Key Reset

---

### Section 1: Security Authorization for the Reset Pass-Code (Continued)

#### Key Points:

- The Reset request can be submitted from the Techstream in the vehicle, or on TIS before the vehicle is available.
- A single management approval can be used multiple times for the same VIN as needed until the vehicle repair is completed.
- Each Reset attempt for the same VIN will generate a new Seed Number and a unique Pass-Code.
- The request and approval hand-off between technician and management is done on the TIS home page inbox accessed at each individual's location (Techstream, office, etc.).

#### Main Steps:

1. Obtain Authorization
  - A. Technician Reset Approval Request
  - B. Manager Access TIS In-Box Message and Approve
2. Perform Reset with Techstream
  - A. Access Approval In-Box Message
  - B. Perform Reset at Vehicle

#### Variations:

1. Pre-approval before vehicle is accessed (as per above Main Steps)
2. Request and receive approval from Techstream after entering the reset utility
3. Repeated reset attempts with Techstream by accessing the single approval file

#### Approving Managers:

Once the Pass-Code Request form has been completed an approval request will be sent to all approving managers. Dealership personnel with the following job titles in "Staffmaster" are granted Pass-Code approval capability.

*Dealer Principal, General Manager, Service Manager, Service Director, Service/Parts Director, Parts Manager, Parts Director, Customer Relations Manager, Customer Satisfaction Manager, Shop Foreman, Diagnostic Specialist, Team Leader. Each dealer must have at least 2 enrolled managers in order to access any Pass-Codes.*

## Immobilizer and Smart Key Reset

### Section 1: Security Authorization for the Reset Pass-Code (Continued)

**NOTE**

Once a Reset is completed, it may be necessary to enter an "Immobilizer Key Registration" or a "Smart Key Code Registration" utility to program the new keys. Early Immobilizer systems may be ready to accept keys immediately after the Reset if the security light flashes a 2-digit code (such as 21 or 22). Refer to the applicable Repair Manual for details.

Please review the Techstream and TIS screenshots in this bulletin to become familiar with the new management authorization process flow.

### Section 2: Reset Approval Request (TIS Pre-Approval)

1. Open TIS and enter the *Diagnostics* and *Immobilizer Reset* tabs. Login using your password.

Figure 2.

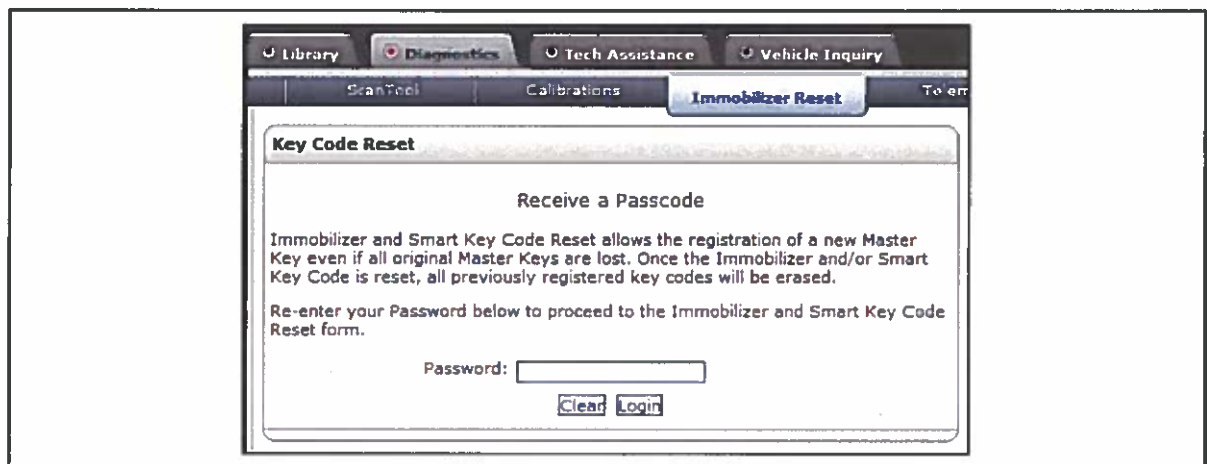

## Immobilizer and Smart Key Reset

### Section 2: Reset Approval Request (TIS Pre-Approval) (Continued)

2. Enter the information requested, check all 4 boxes below *Positive Identification Policy*, then click *Next*.

Figure 3.

Library | Diagnostics | Tech Assistance | Vehicle Inquiry

ScanTool | Calibrations | **Immobilizer Reset** | Key Code | Telematics

**Key Code Reset**

Please complete the following fields to receive a passcode.

Dealer Code:  
 Dealer Name:  
 Technician Name:

\* Vehicle VIN:    (17 digit VIN)

\* Repair Order/Parts Invoice Number:

\* Customer Last Name:

**Positive Identification Policy**

- I have verified the customer's authority to obtain vehicle security information for this vehicle.
- I have verified the customer's full legal name and confirmed their identity with a valid picture ID.
- I have or will visually confirm the vehicle's registration document and ownership.
- I agree to the TIS Terms and Conditions.

(\*) - Indicates Required Field(s)

**Note:** Details of this transaction will be included in the Monthly Vehicle Security Transaction Report sent to the Dealer GM. Also, a log of each transaction is sent to the National Insurance Crime Bureau.

Back Clear Next

3. A minimum of two managers are required to be selected. Once two or more managers are selected, click *Submit* to continue. Each request is required to be approved by one manager. Once manager approval is received, continue to Section 5, "Receipt of Pass-Code."

Figure 4.

Select a minimum of two managers from the list below and click Submit to continue. Each request requires approval from one manager.

Example Manager 1	<input type="checkbox"/>
Example Manager 2	<input type="checkbox"/>
Example Manager 3	<input type="checkbox"/>
Example Manager 4	<input checked="" type="checkbox"/>
Example Manager 5	<input checked="" type="checkbox"/>

Submit Cancel

## Immobilizer and Smart Key Reset

### Section 3: Techstream Reset Utility (With Request)

1. Connect Techstream to the vehicle.

Figure 5.

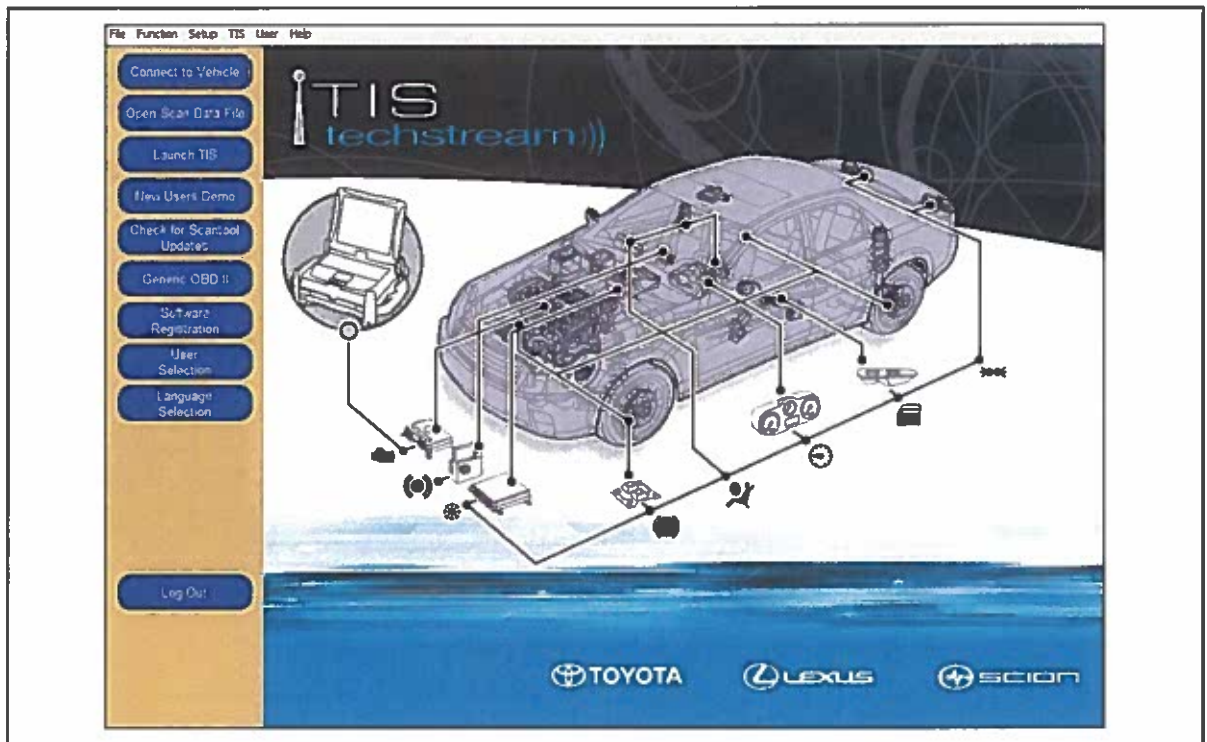

## Immobilizer and Smart Key Reset

### Section 3: Techstream Reset Utility (With Request) (Continued)

2. Choose the appropriate vehicle model and year if the ignition cannot be turned on and the information does not automatically populate.

Figure 6.

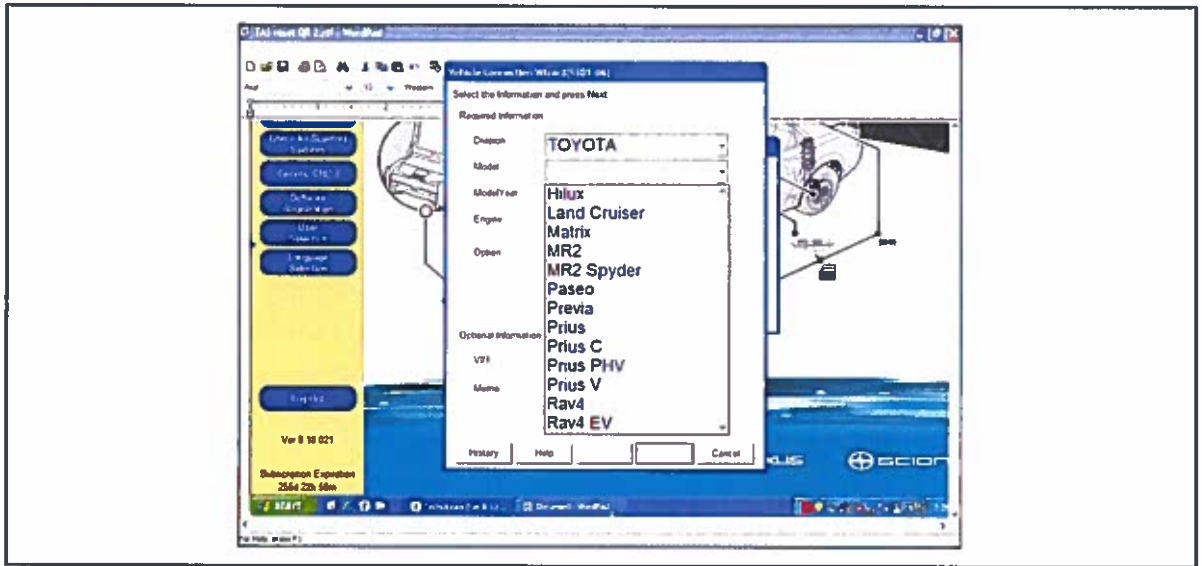

3. Choose the Immobilizer or Smart Key system as needed.

Figure 7.

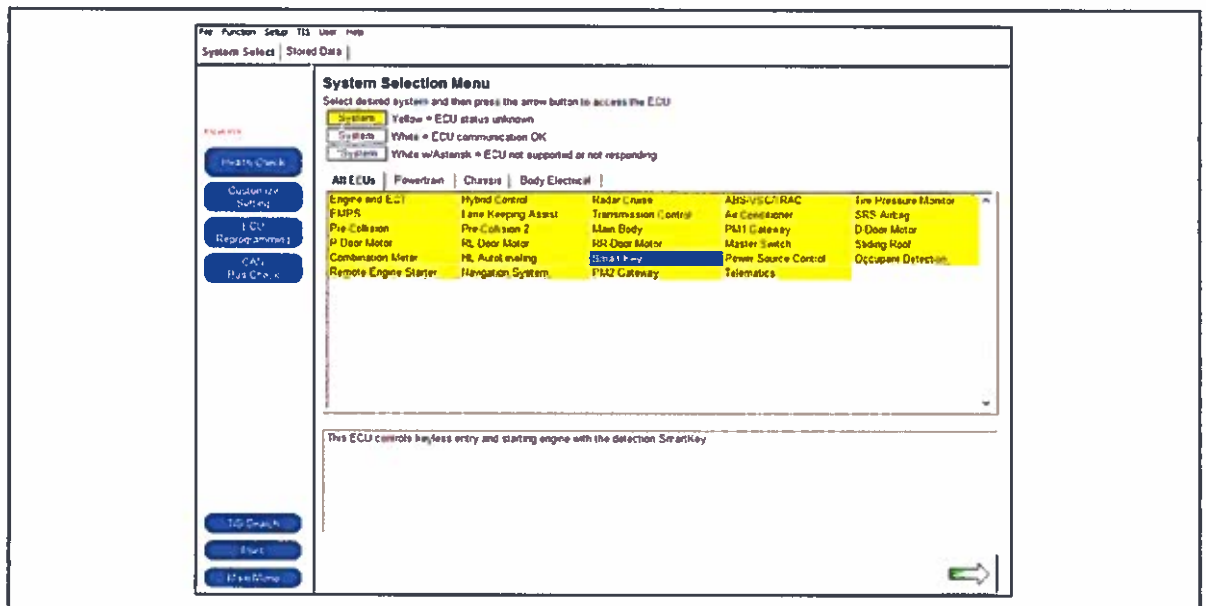



## Immobilizer and Smart Key Reset

### Section 3: Techstream Reset Utility (With Request) (Continued)

4. Choose the Immobilizer or Smart Code Reset utility.

Figure 8.

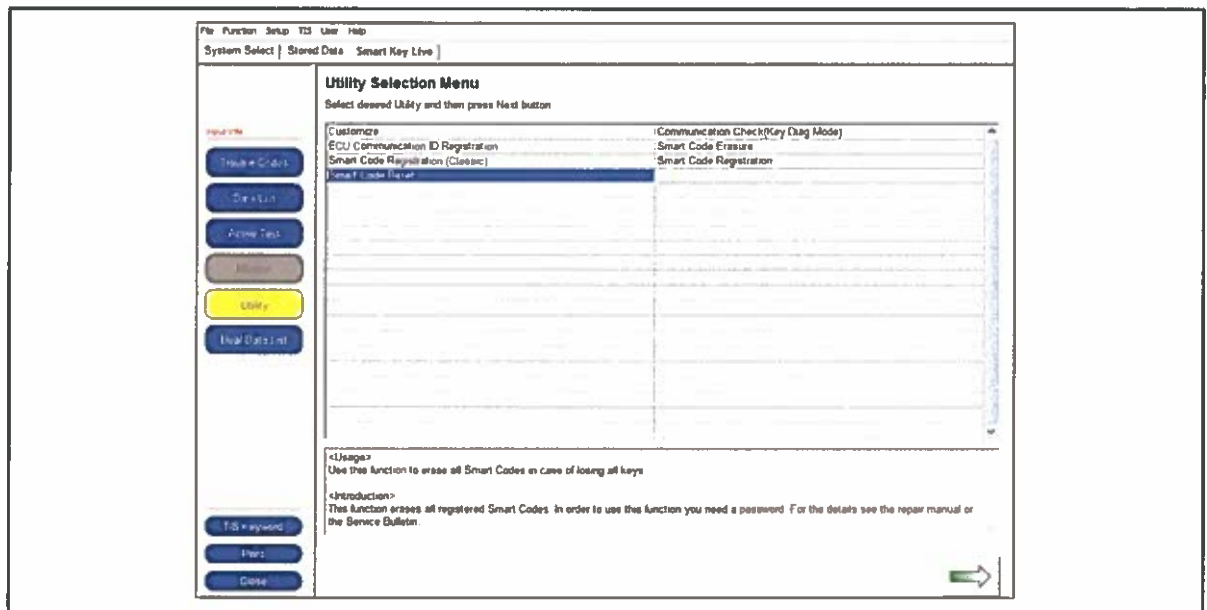

5. Enter the VIN if prompted.

Figure 9.

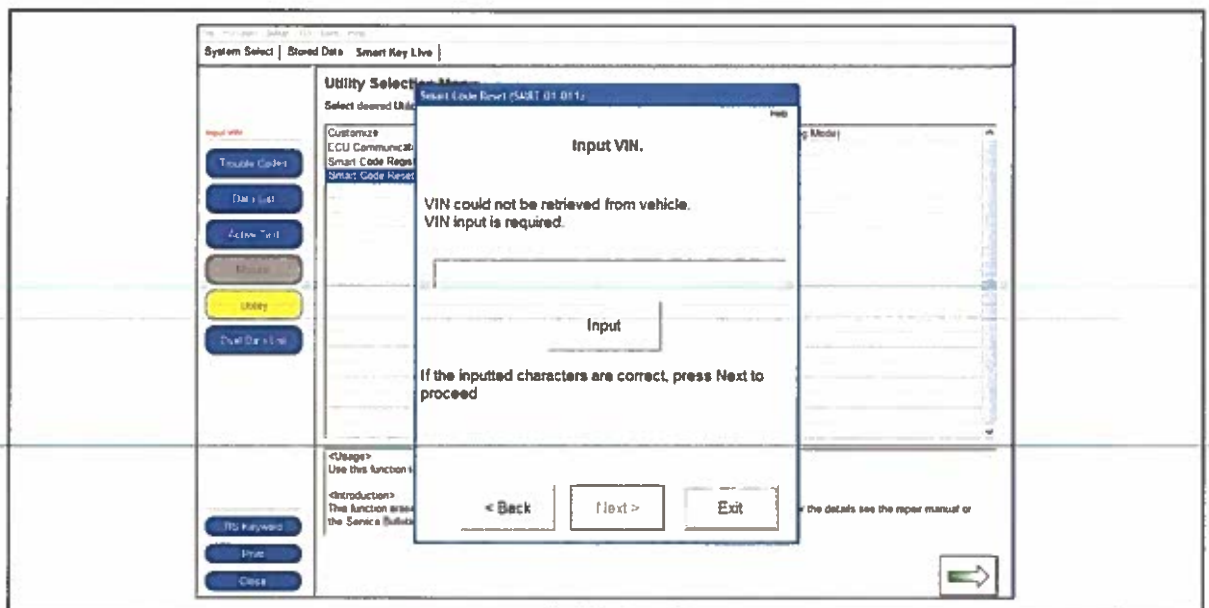

# Immobilizer and Smart Key Reset

## Section 3: Techstream Reset Utility (With Request) (Continued)

6. Techstream will generate a Seed Number. Click *Get Pass-Code*.

Figure 10.

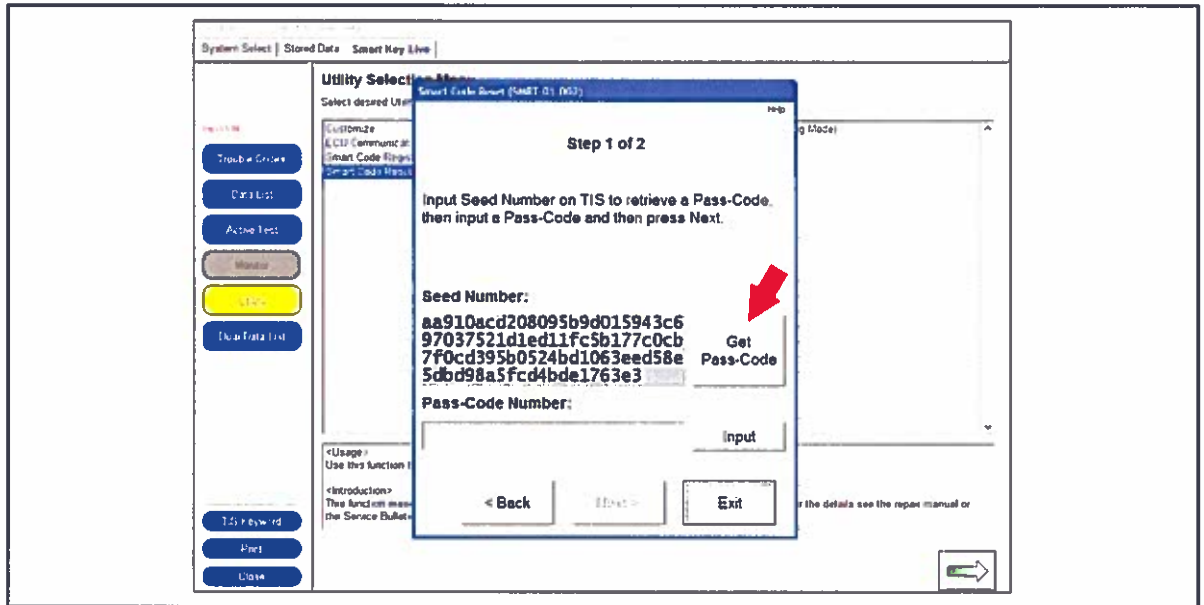

7. Click *Send* to connect to TIS.

Figure 11.

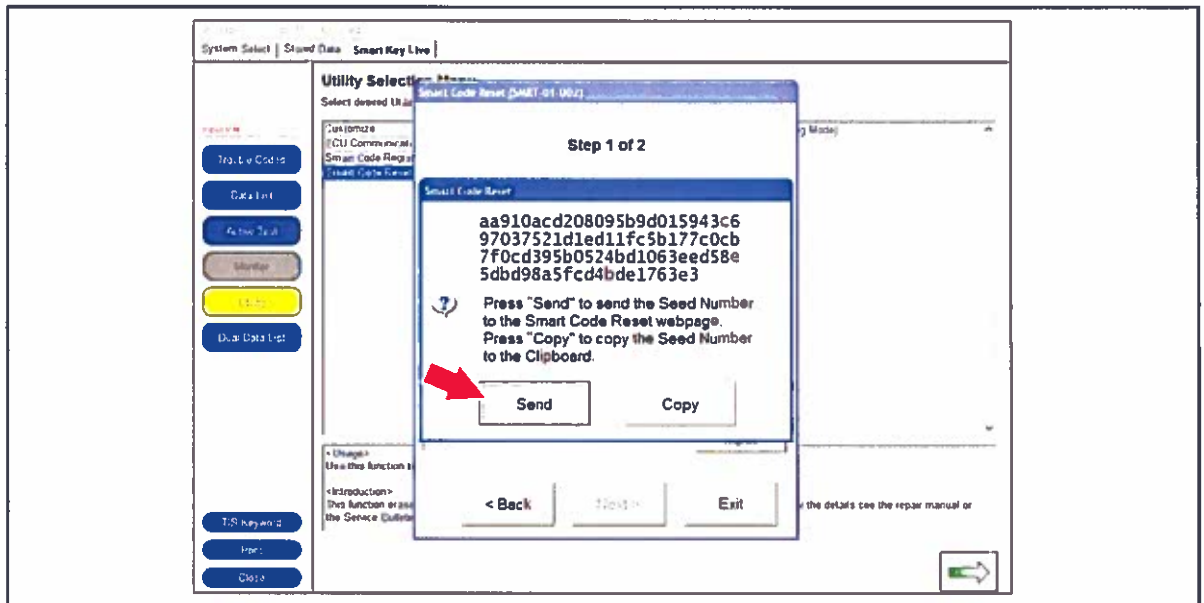

## Immobilizer and Smart Key Reset

### Section 3: Techstream Reset Utility (With Request) (Continued)

**NOTE**

- If there is already a management approval file for this VIN, DO NOT follow the next 3 steps to resubmit a request. Open the approval file in your TIS inbox and enter the most recent Seed Number to get the Pass-Code (as outlined in Section 5, "Receipt of Pass-Code"). Then go to Section 6, "Techstream Reset Utility (Reset Initiated)."
- For repeated Reset attempts after the approval is completed, follow Section 3, "Techstream Reset Utility (With Request)," and Section 6, "Techstream Reset Utility (Reset Initiated)," using the same management approval file.

8. When the TIS window opens, enter your password to login.

Figure 12.

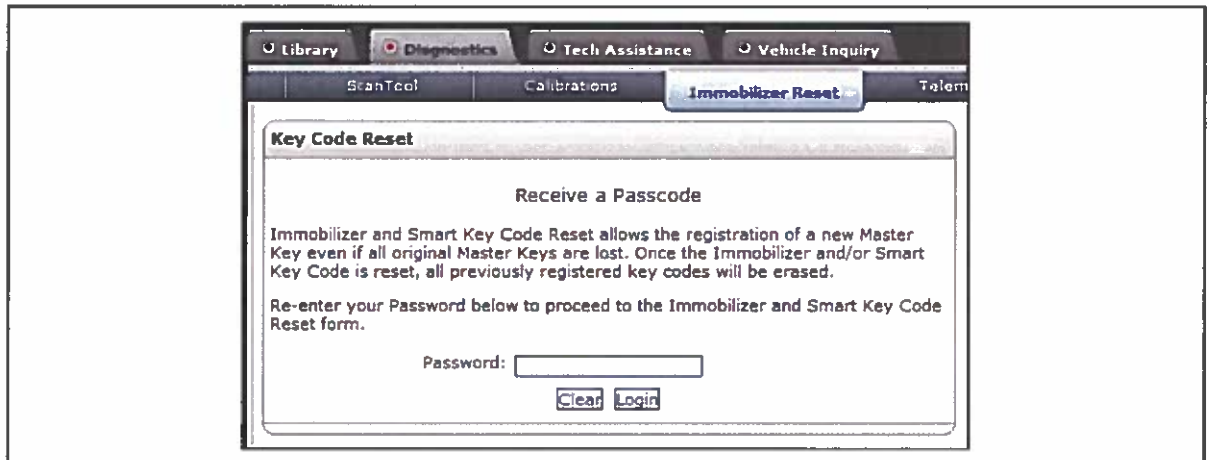

## Immobilizer and Smart Key Reset

### Section 3: Techstream Reset Utility (With Request) (Continued)

9. Fill in the required information and select *Next*.

Figure 13.

Library Diagnostic Tech Assistance Vehicle Inquiry

Scan Tool Calibrations **Immobilizer Reset** Key Code Telematics Navigation

**Key Code Reset**

Please complete the following fields to receive a passcode.

Dealer Code:  
 Dealer Name:  
 Technician Name:

\*Vehicle VIN:    (17 digit VIN)

\*Repair Order/Parts Invoice Number:

\*Customer Last Name:

**Positive Identification Policy**

- I have verified the customer's authority to obtain vehicle security information for this vehicle.
- I have verified the customer's full legal name and confirmed their identity with a valid picture ID.
- I have or will visually confirm the vehicle's registration document and ownership.
- I agree to the Terms and Conditions.

(\*) - Indicates Required Field(s)

**Note:** Details of this transaction will be included in the Monthly Vehicle Security Transaction Report sent to the Dealer GM. Also, a log of each transaction is sent to the National Insurance Crime Bureau.

Back Clear **Next**

10. A minimum of two managers are required to be selected. Once two or more managers are selected, click *Submit* to continue. Each request is required to be approved by one manager. Once manager approval is received, continue to Section 5, "Receipt of Pass-Code."

Figure 14.

Select a minimum of two managers from the list below and click **Submit** to continue. Each request requires approval from one manager.

Example Manager 1	<input type="checkbox"/>
Example Manager 2	<input type="checkbox"/>
Example Manager 3	<input type="checkbox"/>
Example Manager 4	<input checked="" type="checkbox"/>
Example Manager 5	<input checked="" type="checkbox"/>

Submit Cancel

# Immobilizer and Smart Key Reset

## Section 4: Manager Approval (TIS)

1. Once the request has been submitted, one of the authorized dealer managers will locate the technician's request in their TIS home page inbox.

The manager clicks the title to open the Request.

Figure 15.

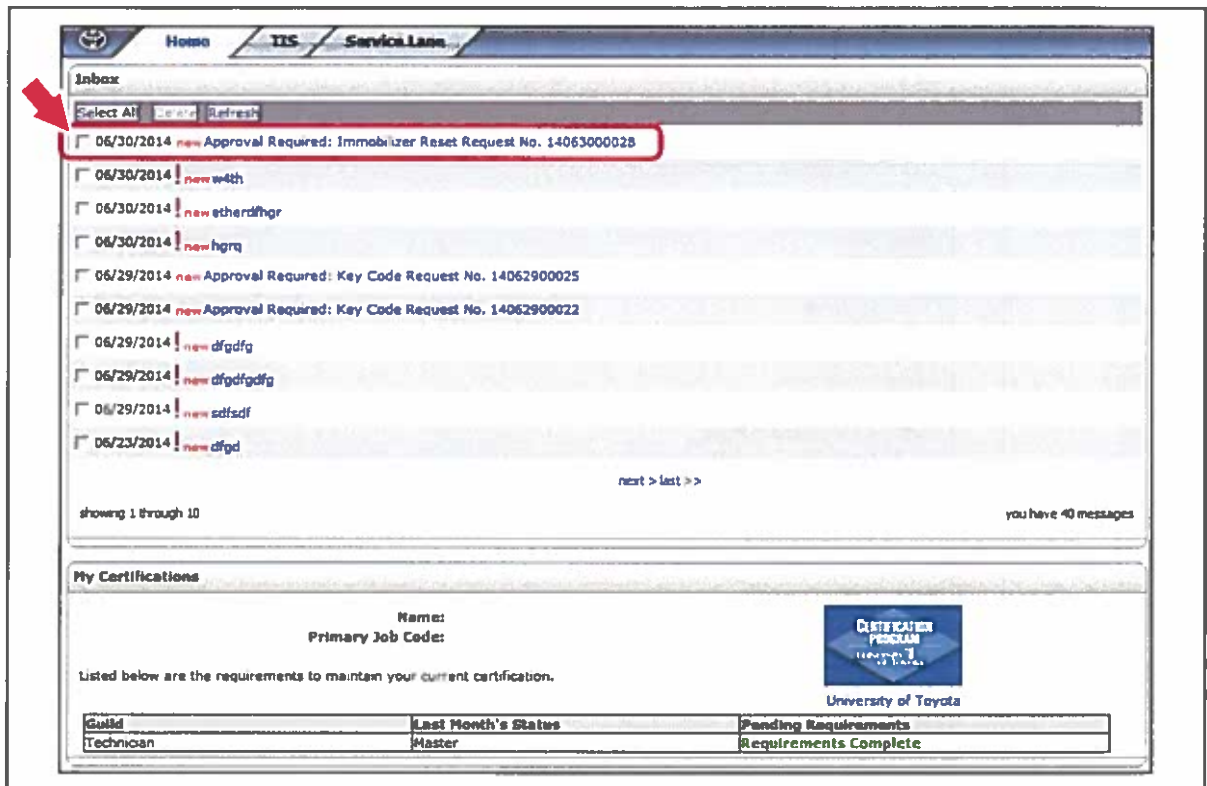

## Immobilizer and Smart Key Reset

### Section 4: Manager Approval (TIS) (Continued)

- The manager checks the 3 boxes under *Request Approval Policy*, then selects *Approve* to send the approval to the technician.

Figure 16.

**Inbox**

**Subject:** Approval Required: Immobilizer Reset Request No. 14070100021

Hello

The user [redacted] has requested to perform an Immobilizer Reset on 07/01/2014 01:27 PM PDT. The details of the request are as follows,

**Request Details:**  
 Request No:  
 Dealer Code:  
 Dealer Name:  
 Technician Name:  
 Vehicle VIN:  
 Repair Order/Parts Invoice Number:  
 Customer Last Name:

**Positive Identification Policy**

I have verified the customer's authority to obtain vehicle security information for this vehicle.  
 I have verified the customer's full legal name and confirmed their identity with a valid picture ID.  
 I have or will visually confirm the vehicle's registration document and ownership.  
 I agree to the TIS Terms and Conditions.

**Request Approval Policy**

\*  I have verified the details entered for this request and confirmed the authority of the customer was verified.  
 \*  I realize that upon retrieval, a transaction log will be posted to the National Insurance Crime Bureau.  
 \*  I agree to the TIS Terms and Conditions.

(\*) - Indicates Required Field(s)

This request will expire in 72 hours from the time of receipt of this message at 07/04/2014 01:27 PM PDT.  
 For assistance, please contact the Dealer Daily Helpdesk.  
**Note:** Details of this transaction will be included in the Monthly Vehicle Security Transaction Report sent to the Dealer GM. Also, a log of each transaction is sent to the National Insurance Crime Bureau.

[Inbox Home](#)

## Immobilizer and Smart Key Reset

### Section 5: Receipt of Pass-Code (TIS)

- Once approved by management, the technician opens his TIS inbox and locates the Reset request. The technician clicks the title to open the Approval.

Figure 17.

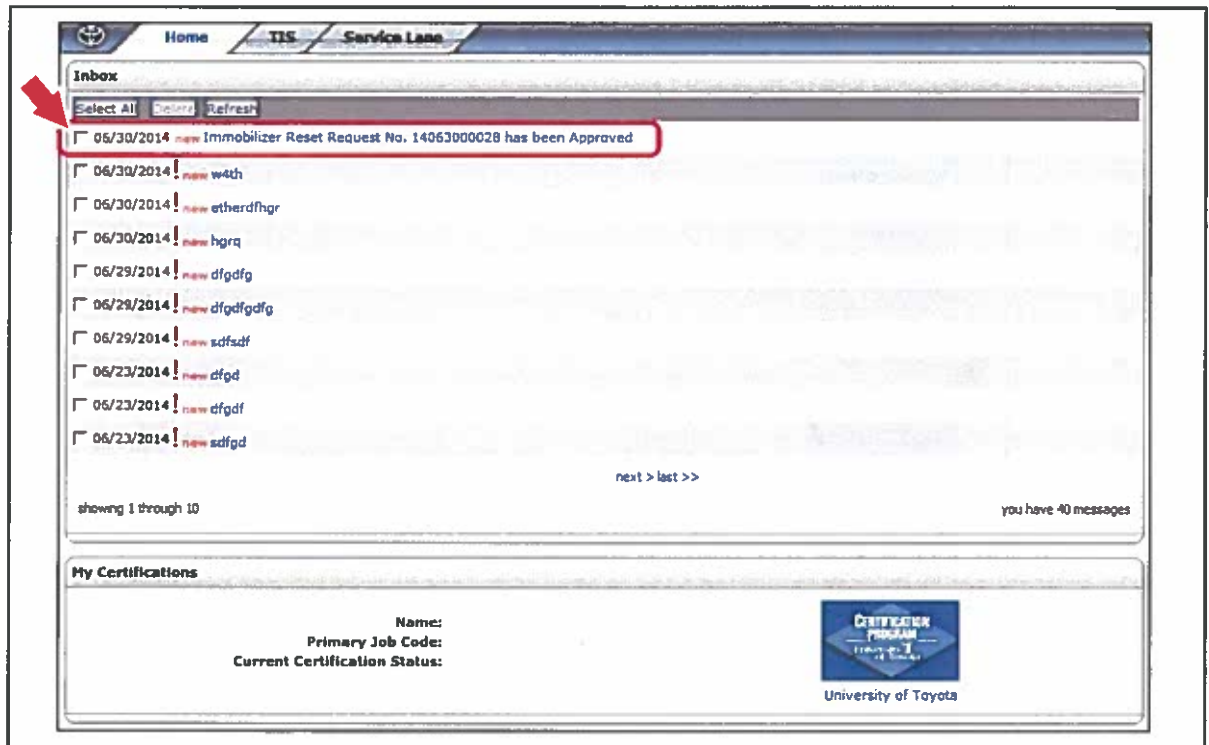

#### NOTE

- It is recommended to retrieve the Pass-Code from the Techstream connected to the vehicle as the Seed Number and Pass-Code work together.
- Once approved by management, multiple resets can be performed for a single VIN. Each attempt will create a new Seed Number and resultant Pass-Code.

## Immobilizer and Smart Key Reset

### Section 5: Receipt of Pass-Code (TIS) (Continued)

2. Once opened, the technician clicks the *Immobilizer Reset* link to continue.

Figure 18.

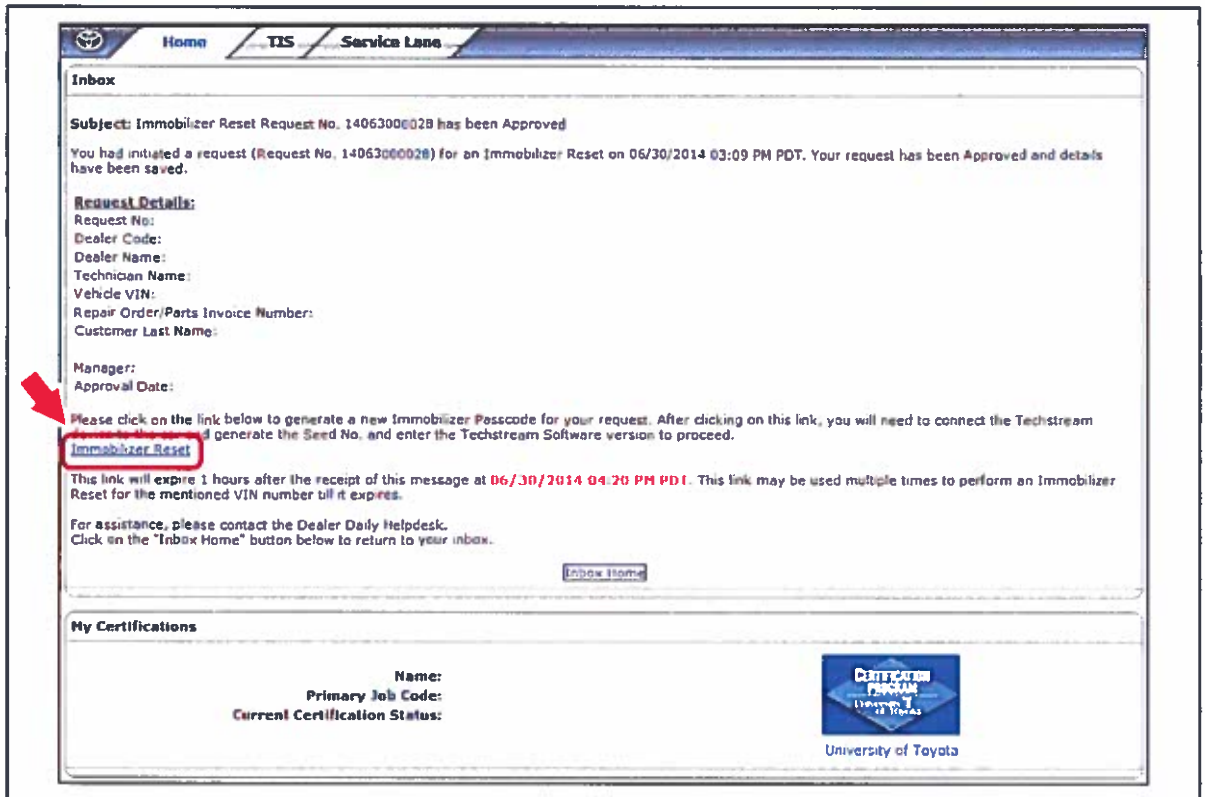

3. At this point, it is necessary for the technician to re-enter their password to login again.

Figure 19.

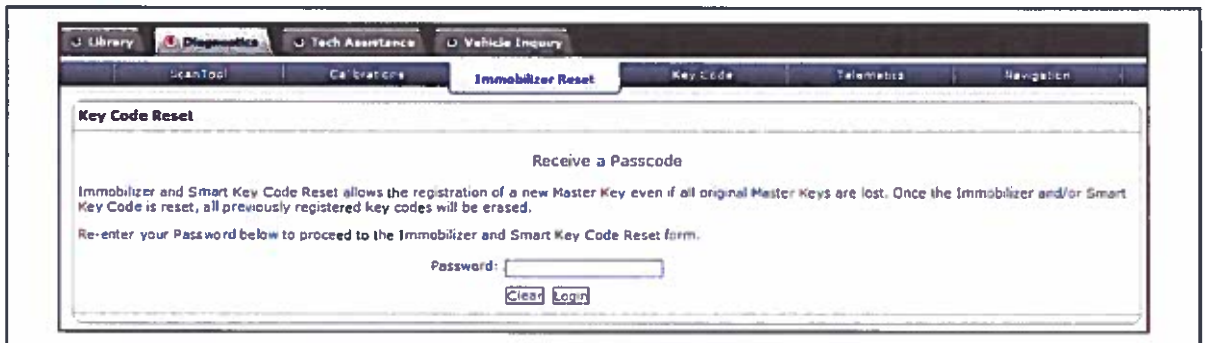



## Immobilizer and Smart Key Reset

### Section 5: Receipt of Pass-Code (TIS) (Continued)

- The technician must enter the Techstream software version and paste in the Seed Number from Techstream, then click *Next*.

Figure 20.

Library | **Diagnosics** | Tech Assistance | Vehicle Inquiry

ScanTool | Calibration | **Immobilizer Reset** | Key Code | Telematics | Navigation

### Key Code Reset

Please complete the following fields to receive a passcode.

Request No:  
 Dealer Code:  
 Dealer Name:  
 Technician Name:

Vehicle VIN:  
 Repair Order/Parts Invoice Number:  
 Customer Last Name:  
 \*Techstream Software Version   
 \*Seed Number (from scantool):

**Positive Identification Policy**

I have verified the customer's authority to obtain vehicle security information for this vehicle.  
 I have verified the customer's full legal name and confirmed their identity with a valid picture ID.  
 I have or will visually confirm the vehicle's registration document and ownership.  
 I agree to the Terms and Conditions.

**Note:** Details of this transaction will be included in the Monthly Vehicle Security Transaction Report sent to the Dealer GM. Also, a log of each transaction is sent to the National Insurance Crime Bureau.

(\* - Indicates Required Field(s))

**Request Status for Request No: 14063000028**

Request Status: Approved  
 Manager:  
 Request Time:  
 Approval Valid Till:

## Immobilizer and Smart Key Reset

### Section 5: Receipt of Pass-Code (TIS) (Continued)

- The Pass-Code will then be provided as shown. Continue to Section 6, "Techstream Reset Utility (Reset Initiated)," for instructions on entering the Pass-Code to initiate the Reset.

Figure 21.

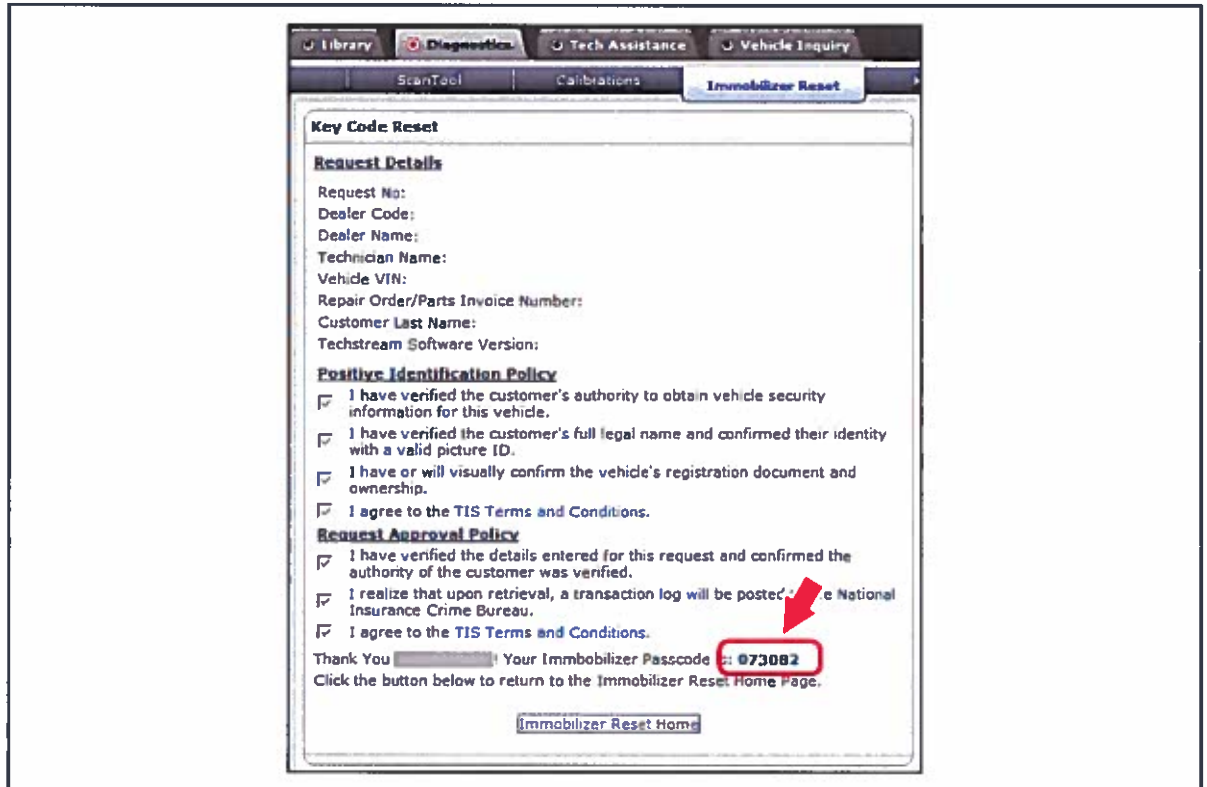

## Immobilizer and Smart Key Reset

### Section 6: Techstream Reset Utility (Reset Initiated)

The Reset can be initiated once the management approval reply is available in the TIS home page inbox. With this approval file, multiple Seed Numbers can be used for as many attempts as needed to repair the vehicle.

**NOTE**

If you have received the file from management in your TIS inbox that shows the approval status for the given VIN, do NOT resubmit for another approval for this vehicle. It will not be necessary. Continue to open the approval file and enter a new Seed Number to get the unique Pass-Code for each attempt.

1. After retrieving the Pass-Code from the manager approval process in Section 4 (“*Manager Approval*”) and Section 5 (“*Receipt of Pass-Code*”), enter the Pass-Code in Techstream and click *Next*.

Figure 22.

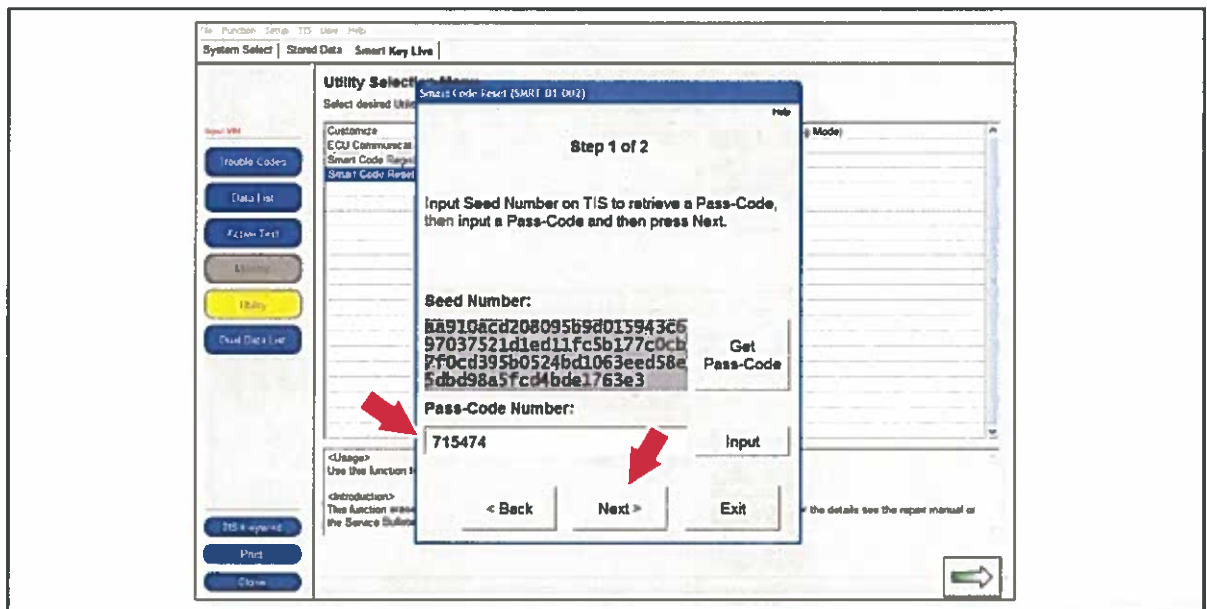

## Immobilizer and Smart Key Reset

### Section 6: Techstream Reset Utility (Reset Initiated) (Continued)

2. Click Yes to start the process.

Figure 23.

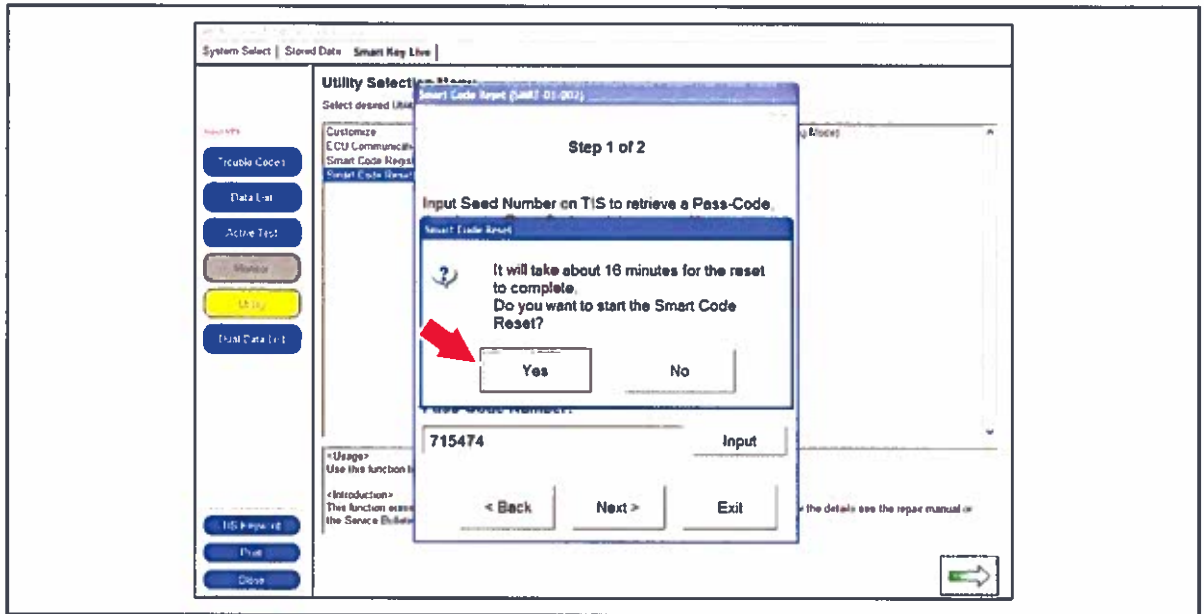
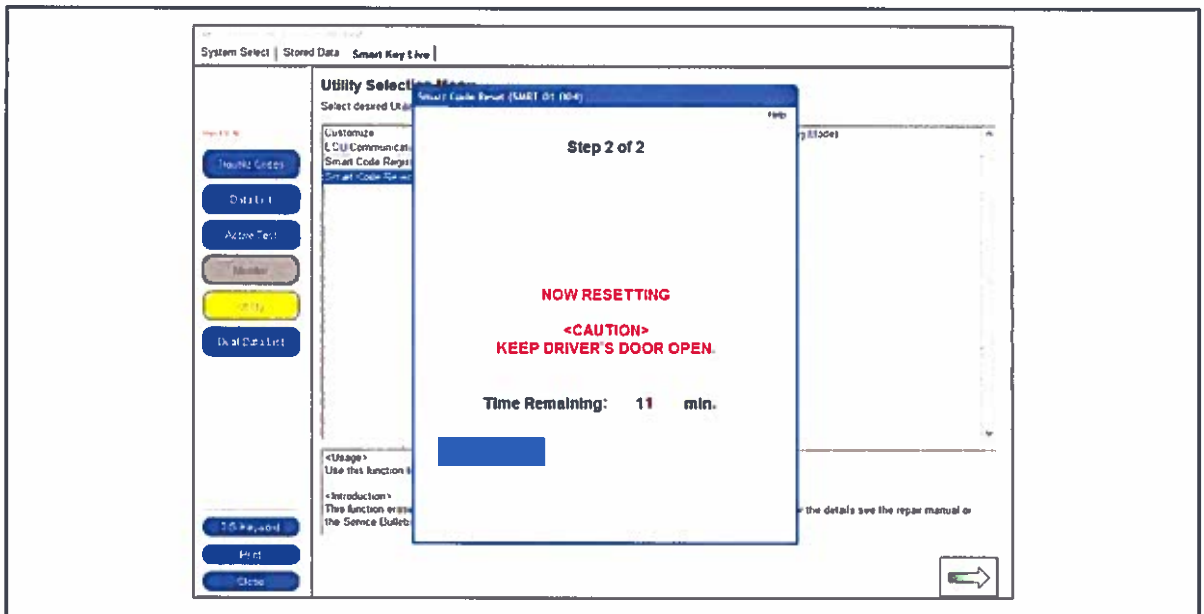

Figure 24.



## Immobilizer and Smart Key Reset

### Section 6: Techstream Reset Utility (Reset Initiated) (Continued)

- Once completed, it may be necessary to enter either the Immobilizer Key Registration or Smart Code Registration utility to program keys.

Figure 25.

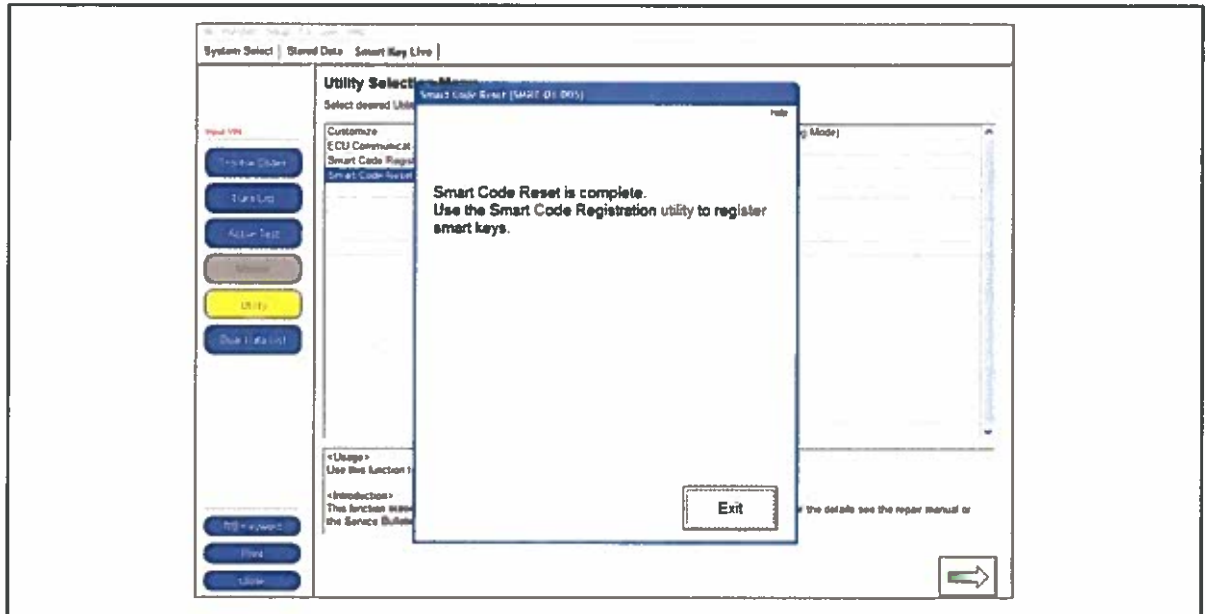

**NOTE**  
 Some early Immobilizer systems go directly into programming mode. This can be confirmed by the security light blinking a 2-digit code. Refer to the applicable Repair Manual for details.

