

Front License Plate & Mounting Bracket Installation

Service Category General

Section Pre-Delivery Service

Market USA

Lexus Supports
ASE Certification 

Applicability

YEAR(S)	MODEL(S)	ADDITIONAL INFORMATION
2015	LS460, LS600H	

Introduction

The front license plate mounting bracket and 2 self-tapping screws for the 2015 model year LS 460 and LS 600h are placed in the luggage compartment of the vehicle at the assembly plant. For states that require a front license plate, install the bracket during Pre-Delivery Service (PDS) according to the following procedures.

Warranty Information

OP CODE	DESCRIPTION	TIME	OFD	T1	T2
N/A	Not Applicable to Warranty	–	–	–	–

Front License Plate & Mounting Bracket Installation

Installation Procedure

1. Align holes "A" of the mounting bracket with the LOWER set of dimples on the front bumper cover. Mark the location of holes "B" on the front bumper cover.

NOTE

- There are 2 sets of dimples on the front bumper cover. Use the LOWER set of dimples.
- Holes "A" are used to install the mounting bracket to the bumper cover.
- Holes "B" are used for installation of the front license plate to the mounting bracket.

Figure 1.

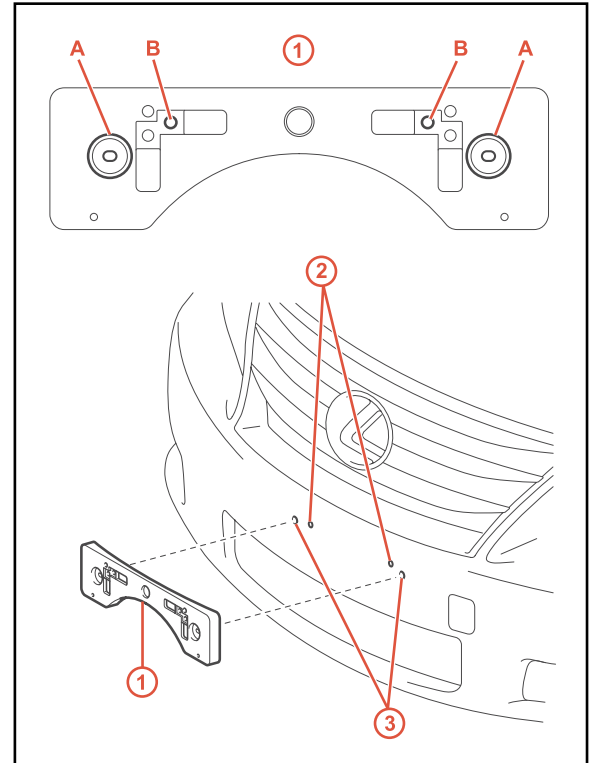

1	Mounting Bracket
2	Mark and Drill Holes
3	Dimples

2. Drill 2 relief holes with a diameter of 11 mm (0.43 in.) at the marks on the front bumper cover (holes "B" location) to prevent the license plate retaining bolt ends from contacting the cover.

NOTE

Do NOT drill into the dimples on the front bumper cover.

3. Install the mounting bracket to the front bumper cover at holes "A" using the 2 supplied self-tapping screws.

Front License Plate & Mounting Bracket Installation

Installation Procedure (Continued)

4. Install the front license plate to the mounting bracket at holes "B" using 2 non-corroding bolts with the following dimensions:

Nominal Length: 15.0 mm (0.59 in.)

Diameter: 6.0 mm (0.24 in.)

Figure 2. License Plate

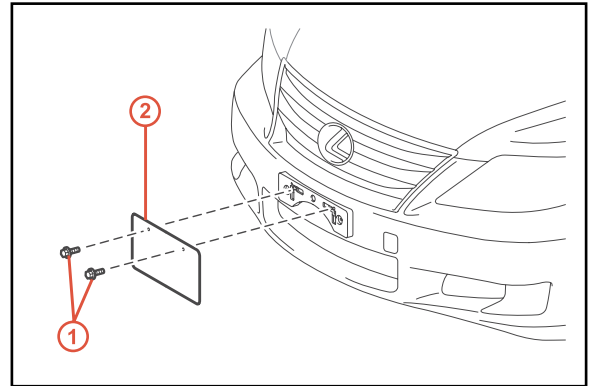

1	Bolts
2	Front License Plate

Figure 3.

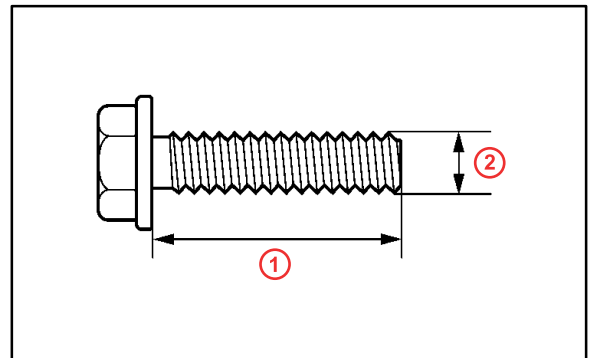

1	Nominal Length
2	Diameter