

SB-10053937-8591

TECHNICAL BULLETIN

Q255NAS1

18 SEP 2013



© Jaguar Land Rover North America, LLC

NOTE: The information in Technical Bulletins is intended for use by trained, professional Technicians with the knowledge, tools, and equipment required to do the job properly and safely. It informs these Technicians of conditions that may occur on some vehicles, or provides information that could assist in proper vehicle service. The procedures should not be performed by 'do-it-yourselfers'. If you are not a Retailer, do not assume that a condition described affects your vehicle. Contact an authorized Land Rover service facility to determine whether this bulletin applies to a specific vehicle.

SECTION: 100-00

Service Action: Water Induced Misfire / Restricted Performance

AFFECTED VEHICLE RANGE:**Range Rover Evoque (LV)**

Model Year: 2012-2013
VIN: CH000447-DH769903

MARKETS:

NAS

CONDITION SUMMARY:

Situation: While driving in wet weather conditions, condensation may build up within the engine Charge Air Cooler. Following a rapid increase in engine speed, this condensation could be drawn in to one of the engine's cylinders, causing the engine management system to sense a misfire. The engine is programmed to react to this misfire by initiating a restricted performance mode to protect the exhaust catalyst. In this mode, the driver noticeably experiences reduced power to accelerate until the engine is switched off and then restarted. Furthermore, an engine warning message will display in the instrument cluster message center and the Engine Malfunction Indicator Lamp may illuminate.

New components have been designed to limit condensation from building in the engine's Charge Air Cooler to prevent the restricted performance mode from initiating. Additionally, updated Engine Control Module (ECM) software has been developed which changes the thresholds necessary to initiate the restricted performance mode for this issue.



NOTE: If Program Code 'Q203' is open in DDW, update the Engine Control Module (ECM) software as directed below and close campaign Q203; do not submit a second ECM software update claim under Program Code Q255. If Program Code Q203 is not open in DDW, complete the ECM software update and submit claim as per the details as shown below.

Action: Retailers are required to **HOLD** all affected vehicles in the above VIN range that are in their control and refrain from releasing the vehicles for new or used vehicle sale pending completion of the rework action detailed in this Technical Bulletin. Unsold vehicles should have this performed as part of the Pre-Delivery Inspection (PDI) process. Affected vehicles already in the hands of customers should be updated at the next available opportunity.

PARTS:

Description	Part No.	Qty.	VIN Range	Expected % of vehicles requiring this part*
Charge Air Cooler venturi tube	LR048122	1	CAN: CH000494-DH769825 USA: CH000447-DH706531	100 100
Charge Air Cooler grille kit	LR048135	1	All	100

Pop rivet	LR049458	8	All	100
-----------	----------	---	-----	-----



NOTE: * when ordering parts, order the expected percentage demand of parts identified only

SPECIAL TOOLS:



NOTE: This document is an 'Active Bulletin' that will display a functional programming shortcut if accessed within a diagnostic session using SDD.

IDS with latest IDS-DVD and Calibration File; first available on DVD133.03 V.129

Jaguar Land Rover-approved Midtronics battery power supply

Refer to Workshop Manual / Service Instruction for any required tools

WARRANTY:



NOTE: Check DDW to ensure that the vehicle is affected by this program prior to undertaking any rework action. Repair procedures are under constant review, and therefore times / prices are subject to change; those quoted here must be taken as guidance only. Refer to the Repair Times Searcher (RTS) on TOPIx to obtain the latest repair time. At the time of confirming a booking for vehicle repair, ensure that all outstanding Service Actions are identified to ensure the correct parts are available and adequate workshop time is allocated for repairs to be completed at one visit.



NOTE: If Program Code 'Q203' is open in DDW, update the Engine Control Module (ECM) software as directed below and close campaign Q203; do not submit a second ECM software update claim under Program Code Q255. If Program Code Q203 is not open in DDW, complete the ECM software update and submit claim as per the details as shown below.

Warranty claims must be submitted quoting Program Code **Q255** together with the relevant Option Code from the table. The SRO and part information listed have been included for information only. The Option Code(s) that allows for the drive in / drive out allowance can only be claimed if the vehicle is brought into the workshop for this action alone to be undertaken.





This program is valid for a limited time only. Warranty claims with a repair date prior to the **30 June 2015** closure date must be submitted for payment within 30 calendar days of completion of the repair.

CANADA ONLY

PROGRAM CODE	OPTION CODE	DESCRIPTION	SRO	TIME (HOURS)	PARTS	QTY. / VALUE
Q255	B	Install venturi tube and grille to Charge Air Cooler Update Engine Control Module software	19.42.89/46 12.90.13	1.70 0.20	LR048122 LR048135 LR049458	1 1 8
Q255	C	Install venturi tube and grille to Charge Air Cooler Update Engine Control Module software Drive in/drive out	19.42.89/46 12.90.13 02.02.02	1.70 0.20 0.20	LR048122 LR048135 LR049458	1 1 8
Q255	L	Install venturi tube and grille to Charge Air Cooler	19.42.89/46	1.70	LR048122 LR048135	1 1

					LR049458	8
Q255	M	Install venturi tube and grille to Charge Air Cooler Drive in/drive out	19.42.89/46 02.02.02	1.70 0.20	LR048122 LR048135 LR049458	1 1 8

USA ONLY

PROGRAM CODE	OPTION CODE	DESCRIPTION	SRO	TIME (HOURS)	PARTS	QTY. / VALUE
Q255	B	 NOTE: VIN CH000447-DH706531 ONLY Install venturi tube and grille to Charge Air Cooler Update Engine Control Module software	19.42.89/46 12.90.13	1.70 0.20	LR048122 LR048135 LR049458	1 1 8
Q255	C	 NOTE: VIN CH000447-DH706531 ONLY Install venturi tube and grille to Charge Air Cooler Update Engine Control Module software Drive in/drive out	19.42.89/46 12.90.13 02.02.02	1.70 0.20 0.20	LR048122 LR048135 LR049458	1 1 8
Q255	F	 NOTE: VIN DH706533-DH769909 ONLY Install grille to Charge Air Cooler Update Engine Control Module software	19.42.89/47 12.90.13	1.70 0.20	LR048135 LR049458	1 8
Q255	G	 NOTE: VIN DH706533-DH769909 ONLY Install grille to Charge Air Cooler Update Engine Control Module software Drive in/drive out	19.42.89/47 12.90.13 02.02.02	1.70 0.20 0.20	LR048135 LR049458	1 8
Q255	L	Install venturi tube and grille to Charge Air Cooler	19.42.89/46	1.70	LR048122 LR048135 LR049458	1 1 8
Q255	M	Install venturi tube and grille to Charge Air Cooler Drive in/drive out	19.42.89/46 02.02.02	1.70 0.20	LR048122 LR048135 LR049458	1 1 8

**NOTE: Normal Warranty policies and procedures apply****SERVICE INSTRUCTION:****NOTE: Some variation in the illustrations may occur, but the essential information is always correct.**

Step 1: all vehicles

1.  **NOTE: It is not necessary to remove the front wheel and tire during the fender splash shield removal procedure.**

-  **NOTE: Note the orientation of the Charge Air Cooler (CAC) prior to removal.**

Remove the engine Charge Air Cooler (CAC) (see TOPIx Workshop Manual, Section 303-12B).

Steps 2-8: all Canada vehicles and USA vehicles only up to VIN DH706531

2.  **NOTE: Charge Air Cooler (CAC) shown removed from the vehicle for clarity.**

Note the required orientation of the venturi prior to installation.

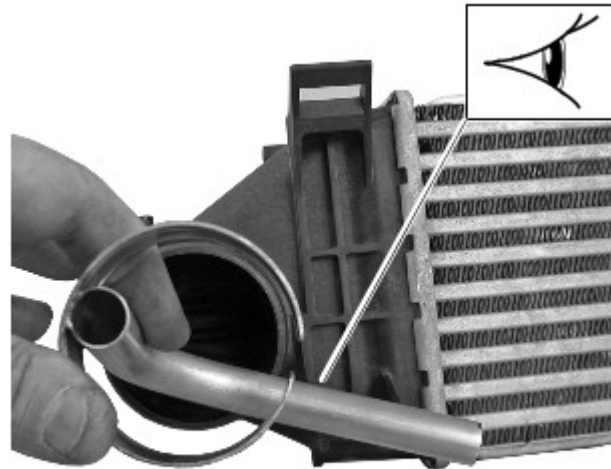

E149136

3.  **CAUTION: The venturi ring will need to be slightly compressed during installation. Make sure that the ring is not compressed so that the ends of the ring overlap. Failure to follow this instruction may result in damage to the vehicle.**

Note the acceptable deformation of the venturi ring prior to installation.

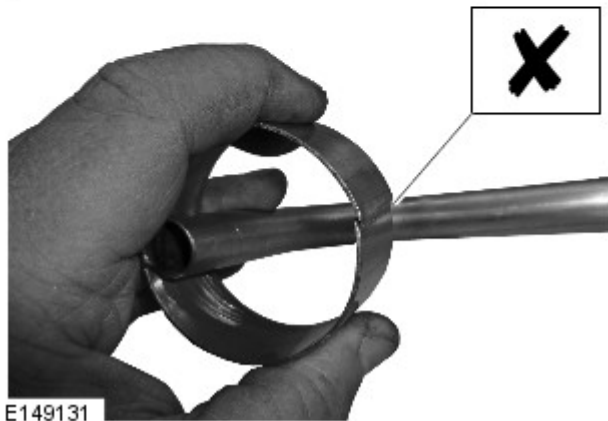
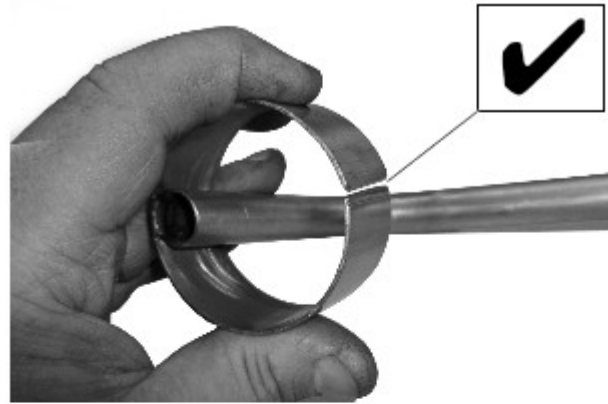

E149131

- 4.  **CAUTION: Make sure that the sensor is not damaged during the installation of the venturi.**

Note the position of the sensor.

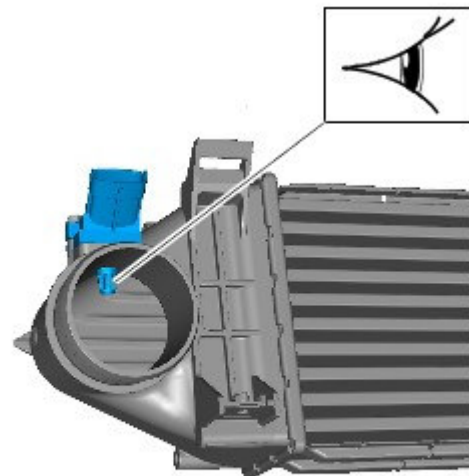

E149137

5. Insert the venturi in to the Charge Air Cooler.

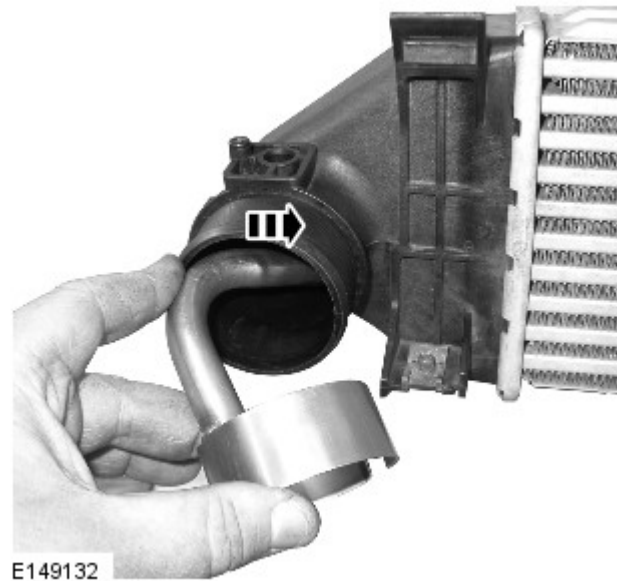

6. Make sure that the venturi is correctly aligned.

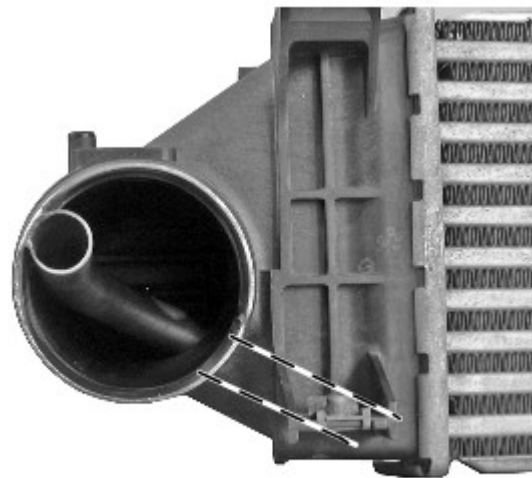

7. Carefully slide the venturi forwards until it is flush inside the Charge Air Cooler.

- Carefully compress the venturi ring.
- Slide the venturi in to the flush position.

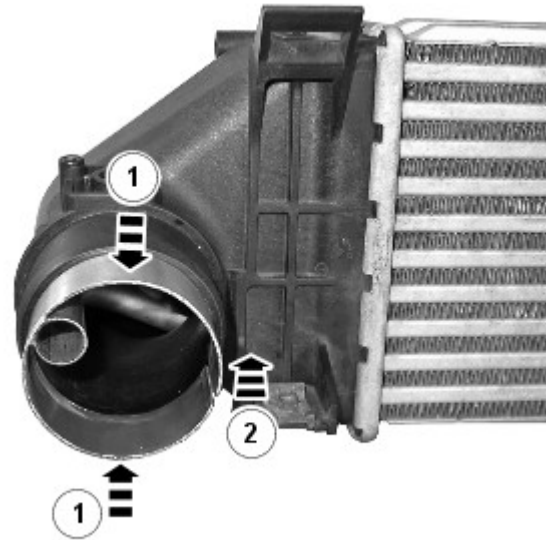

E149134

8. Rotate the venturi clockwise until you feel it touch the bottom of the Charge Air Cooler.

- Rotate the venturi counter-clockwise.
- Rotate the venturi clockwise.





E149135

Steps 9-23: all vehicles

9.  **NOTE: Upper section of Charge Air Cooler shown; lower section similar.**

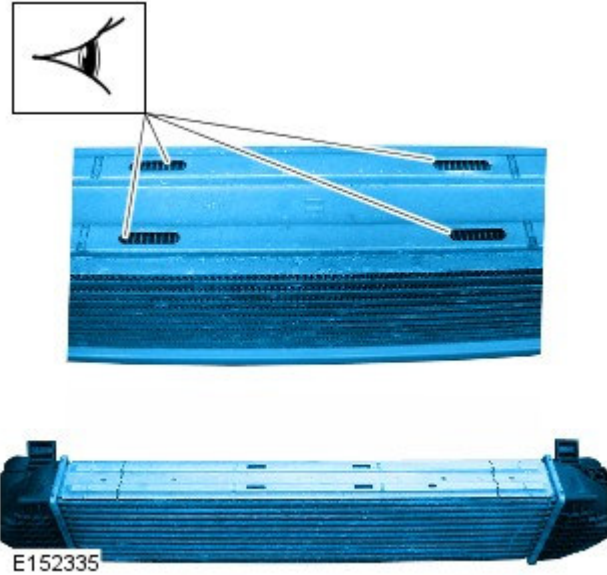
Identify the eight (8) slots on the Charge Air Cooler.



10.  **CAUTION:** Make sure that upper section of the Charge Air Cooler grille is secured with all four (4) rivets before attempting to rotate the assembly. Failure to follow this instruction may result in the dislodging of the rivet(s), resulting in damage to the component.

 **NOTE:** Upper section of Charge Air Cooler shown; lower section similar.

Secure the Charge Air Cooler grille.

- Install the Charge Air Cooler grille to the Charge Air Cooler with the wider section at the top of the Charge Air Cooler.
- Install four (4) rivets to the upper section of the Charge Air Cooler grille.
- Rotate the assembly and install four (4) rivets to the lower section of the Charge Air Cooler grille.

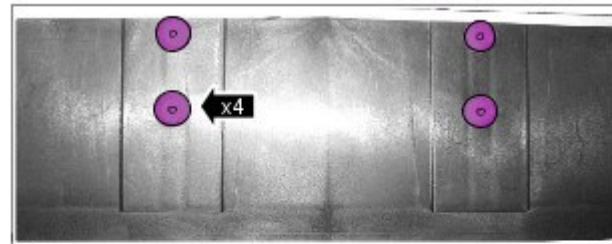

11. Install the Charge Air Cooler (see TOPIx Workshop Manual, Section 303-12B).

12.  **CAUTION:** Ensure all ignition 'ON' / ignition 'OFF' requests are carried out; failure to perform these steps may cause damage to control modules in the vehicle.

 **CAUTION:** A Jaguar Land Rover-approved Midtronics battery power supply must be connected

to the vehicle battery during IDS / SDD diagnosis / module programming.



NOTE: IDS must be loaded with DVD133.03 v.129 or later.

Connect the Jaguar Land Rover-approved Midtronics battery power supply to the vehicle battery.



NOTE: The Engine Control Module (ECM) may also be known as Powertrain Control Module (PCM).

13. Turn ignition 'ON' (engine not running).
14. Connect SDD to the vehicle and begin a new diagnostic session, by reading the VIN for the current vehicle and initiating the data collect sequence.
15. Follow the SDD prompts.
16. Select 'Diagnosis' from the Session Type screen.
17. Select the 'Selected Symptoms' tab, and then select the following:
 - Powertrain > Engine system > Engine performance
18. Select 'continue'.
19. Select the 'Extras' tab.



20. **NOTE: The Engine Control Module (ECM) may also be known as Powertrain Control Module (PCM).**

Select **Run** to perform the 'Configure existing module – Powertrain control module' option.

21. Follow all on-screen instructions to complete this task.
22. Exit the current session.
23. Disconnect the IDS and the battery power supply from the vehicle.