



# SERVICE CAMPAIGN BULLETIN

Reference:

NTB11-066

Date:

August 10, 2011

## VOLUNTARY SERVICE CAMPAIGN 1996-2004 PATHFINDER IN NON SALT STATES LEFT FRONT STRUT HOUSING CORROSION

**CAMPAIGN ID #:** R1108  
**NHTSA #:** 11V-244  
**APPLIED VEHICLES:** 1996 – 2004 Pathfinder (R50)

**Check Service COMM to confirm campaign eligibility.**

### INTRODUCTION

Nissan is conducting a voluntary safety recall campaign on certain model year 1996 – 2004 Pathfinder vehicles that are currently registered in Salt States to inspect for corrosion, and if necessary repair the front strut housing panels. The Salt States are listed below. For vehicles currently registered in these States, please refer to NTB11-064.

**Non-Salt States** (This bulletin applies.)

**Salt States** (Refer to NTB11-064.)

Maine, New Hampshire, Vermont, Massachusetts, Rhode Island, Connecticut, New York, New Jersey, Pennsylvania, Delaware, Maryland, West Virginia, Ohio, Indiana, Michigan, Illinois, Wisconsin, Minnesota, Iowa, and Missouri and the District of Columbia.

In addition to the recall campaign, in the interest of customer satisfaction, owners of similar vehicles that are not subject to the recall because they were originally sold in and are registered in States where corrosion is unlikely to occur will receive a courtesy notification and will be offered an opportunity to have their vehicles inspected at no charge. If necessary, the vehicles will also be remedied free of charge.

### IDENTIFICATION NUMBER

Nissan has assigned identification number R1108 to this campaign. This number must appear on all communications and documentation of any nature dealing with this campaign.

### DEALER RESPONSIBILITY

Dealers are to repair vehicles falling within range of this campaign that enter the service department. This includes vehicles purchased from private parties, vehicles presented by transient (tourists) owners, and vehicles in a dealer's inventory.

## TABLE OF CONTENTS

	Page
REPAIR OVERVIEW .....	3
SERVICE PROCEDURE .....	4
Inspect for Corrosion in the Driver Side Front Wheel House Area .....	4
Determine if Vehicle is Repairable .....	6
Determine Repair Level for Passenger Side .....	10
Driver Side Repair .....	12
Strut Removal .....	12
Repair Bracket Installation .....	15
Patching Perforated Areas .....	31
Passenger Side - Level 1 Repair .....	38
Passenger Side - Level 2 Repair .....	40
STEERING SHAFT REPLACEMENT .....	43
EXAMPLE PHOTOS (perforation and scab corrosion).....	47
REQUIRED SPECIAL TOOLS .....	49
PARTS INFORMATION .....	50
CLAIMS INFORMATION .....	51
OWNER LETTER .....	54
NON REPAIRABLE REPORT .....	55

## REPAIR OVERVIEW

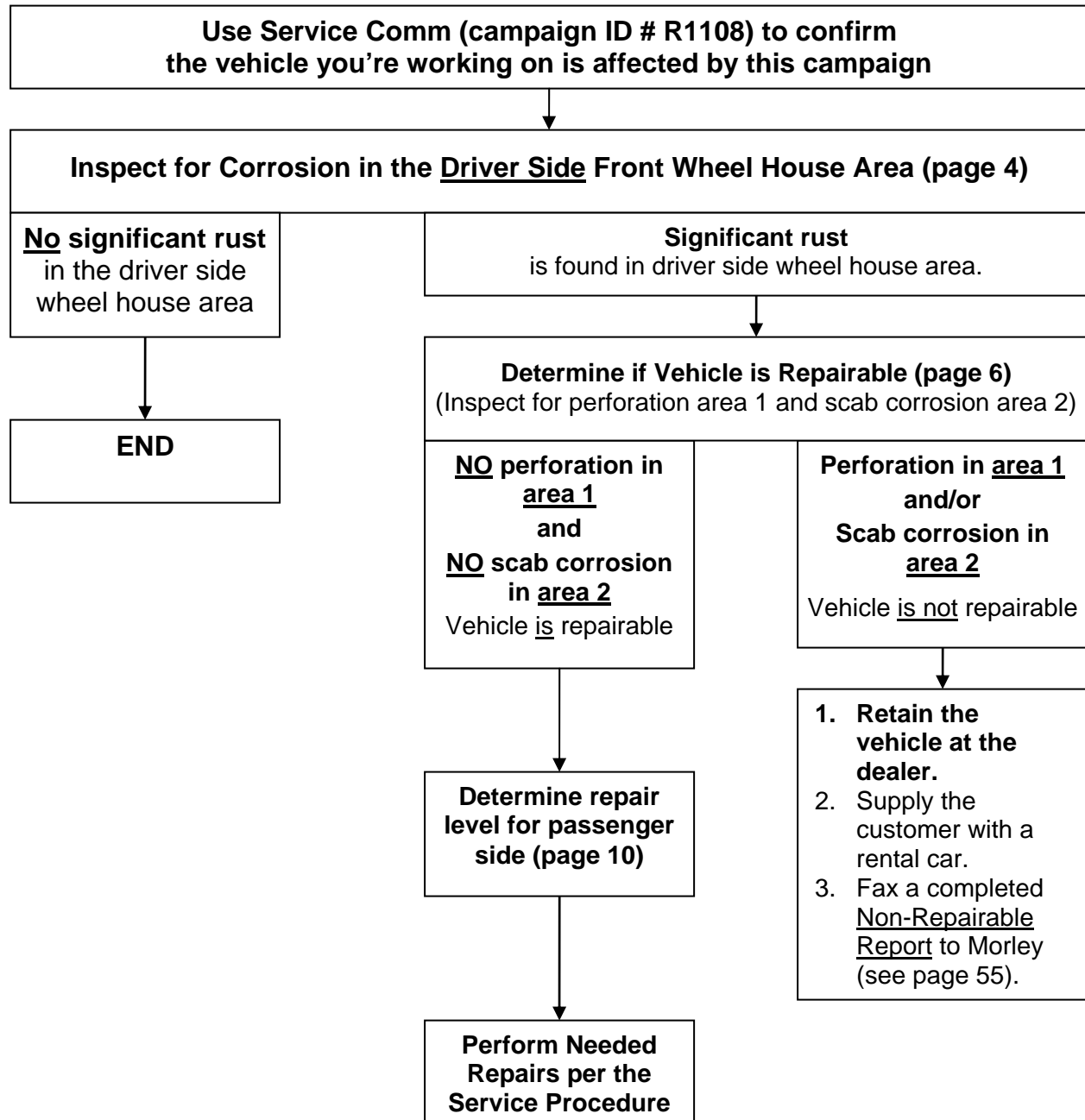

### Possible Repair Levels for Passenger Side

	Use Level 1 Repair If:	Use Level 2 Repair If:
Passenger Side	No perforation (page 38)	Perforation (page 40)

## SERVICE PROCEDURE

**NOTE:** This campaign does not cover any repairs beyond those specifically mentioned in this Service Procedure.

### Inspect for Corrosion in the Driver Side Front Wheel House Area

1. Turn the ignition OFF.
2. Set the parking brake.
3. Look behind the front driver side tire (see Figure A).

**NOTE:** Turning the tire left and then right will allow a better view.



Figure A

4. Visually inspect for corrosion and rust on the wheel housing panel and the strut housing panel.
  - Inspect for corrosion and rust on the **panels only**.

**NOTE:** Corrosion or Rust on the strut or other suspension components is not covered by this campaign.



Figure B

**No significant rust found on the panels.**

- Inspection end.
- Return the vehicle to the customer.

**Significant rust is found on the panels:**

- Go to Determine if Vehicle is Repairable on the next page.

## Determine if Vehicle is Repairable (driver side inspection)

1. Lift the vehicle on a hoist.
2. Remove the left front wheel.
3. Inspect for corrosion on the driver side in the strut housing **Area 1** and wheel house **Area 2** (see Figures 1 through 4).

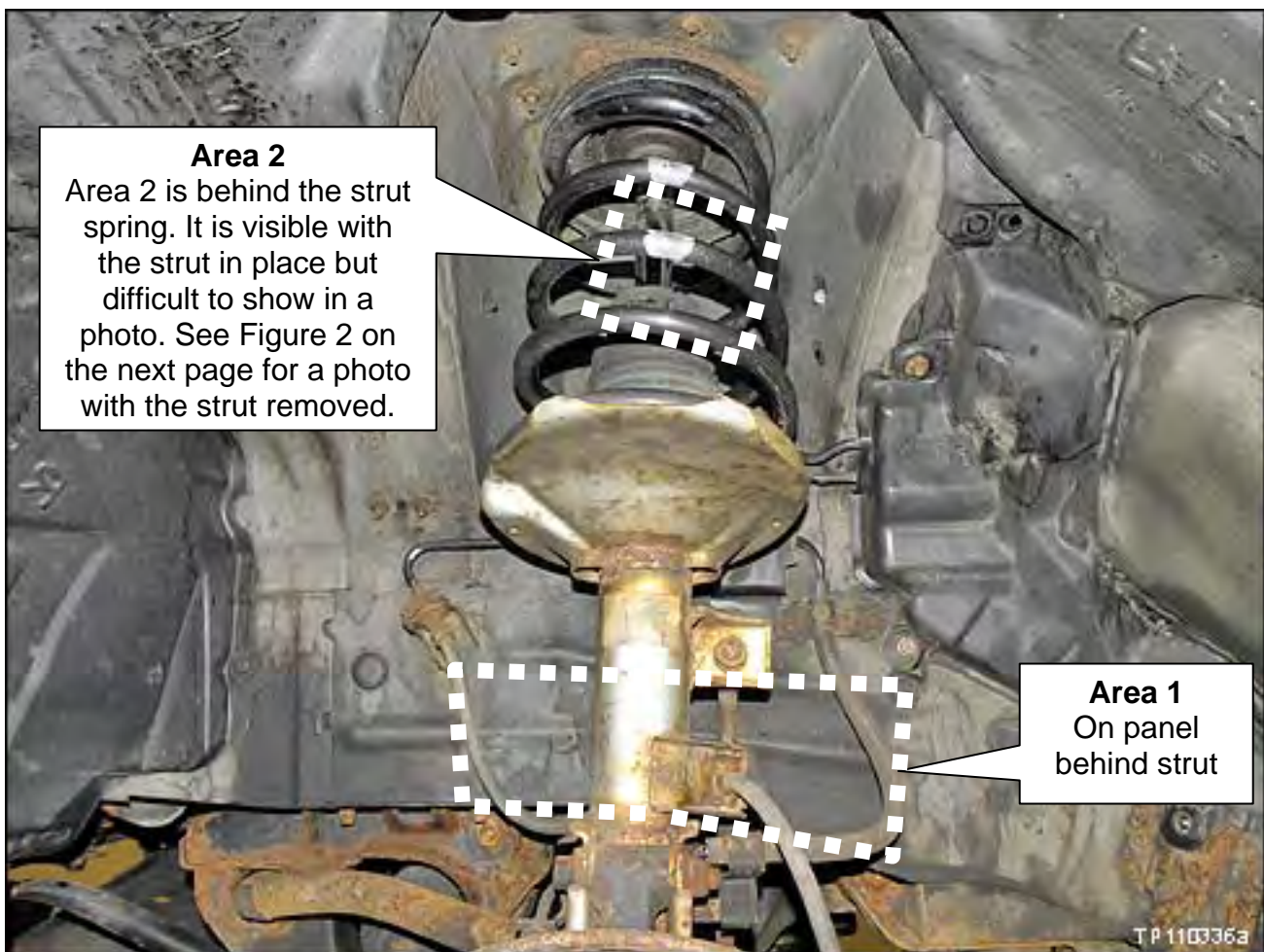

Figure 1

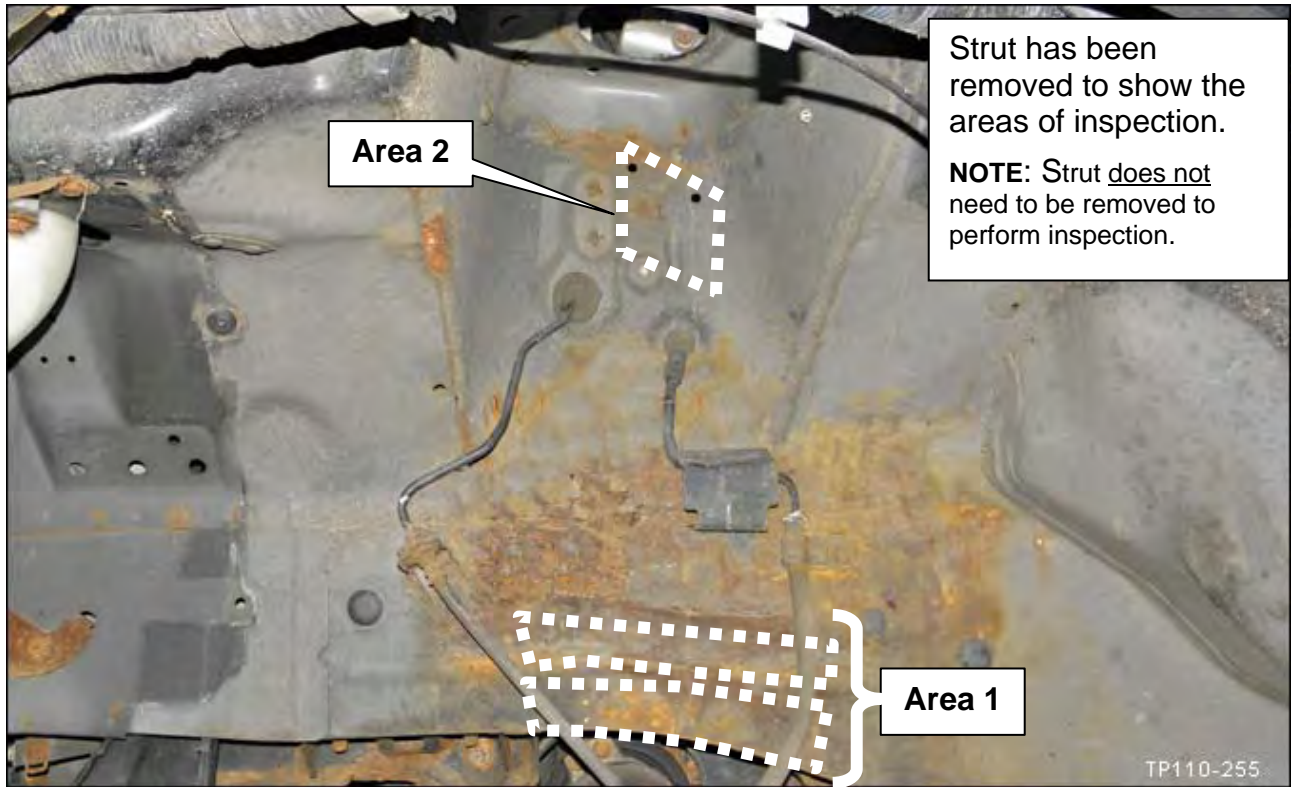

Figure 2

This photo shows the inspection areas in relation to the repair bracket installation.

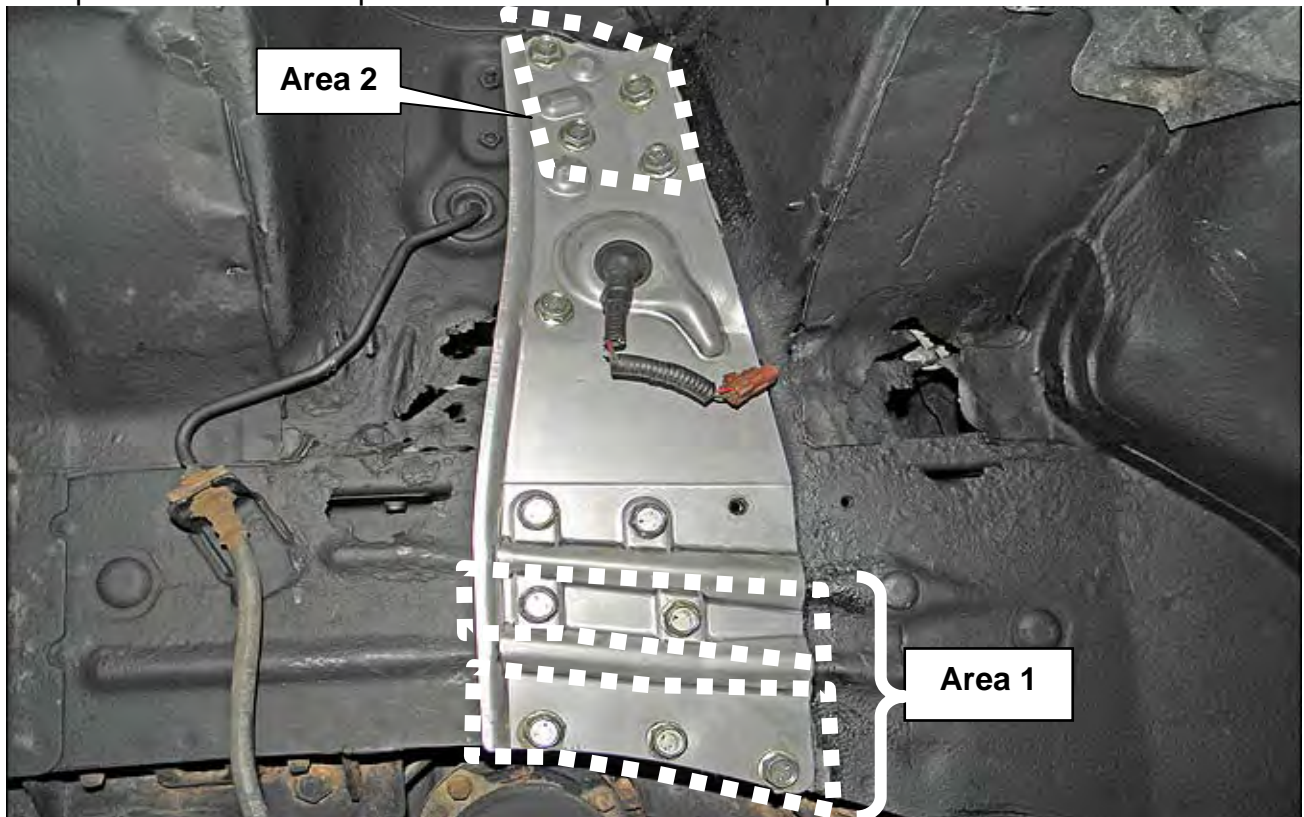

Figure 2A

## Area 1

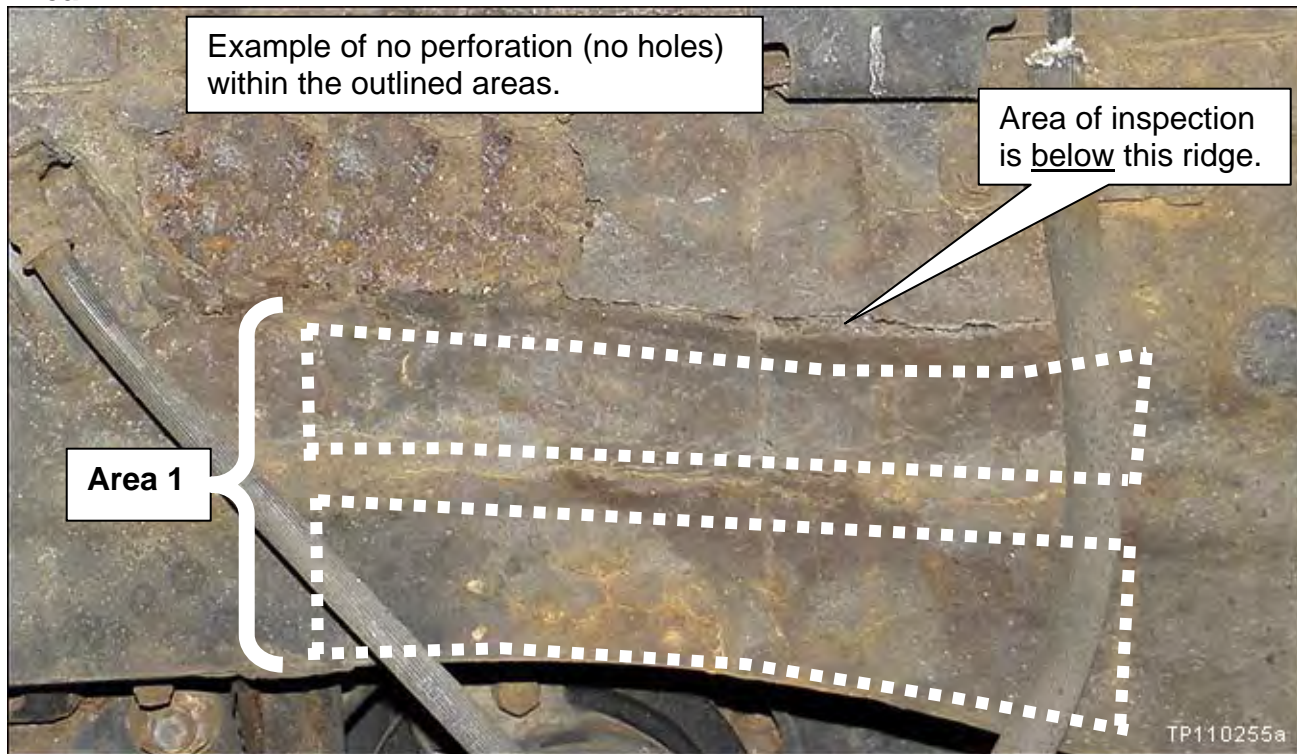

Figure 3

**Area 1:** Look for perforation (holes) in the metal only in the areas outlined above.

**NOTE:** If needed, refer to examples (additional photos) of area 1 perforation inspection on pages 47 and 48.

If there is **perforation** (holes) in the metal in area 1:

- a. Retain the vehicle at the dealer. (The vehicle is not repairable.)
- b. Supply the customer with a rental car.
- c. Fax a completed Non-Repairable Report to Morley (see page 55).

If there is **no perforation** (no holes) in the metal in area 1:

- Go to Area 2 on the next page.



## Area 2:

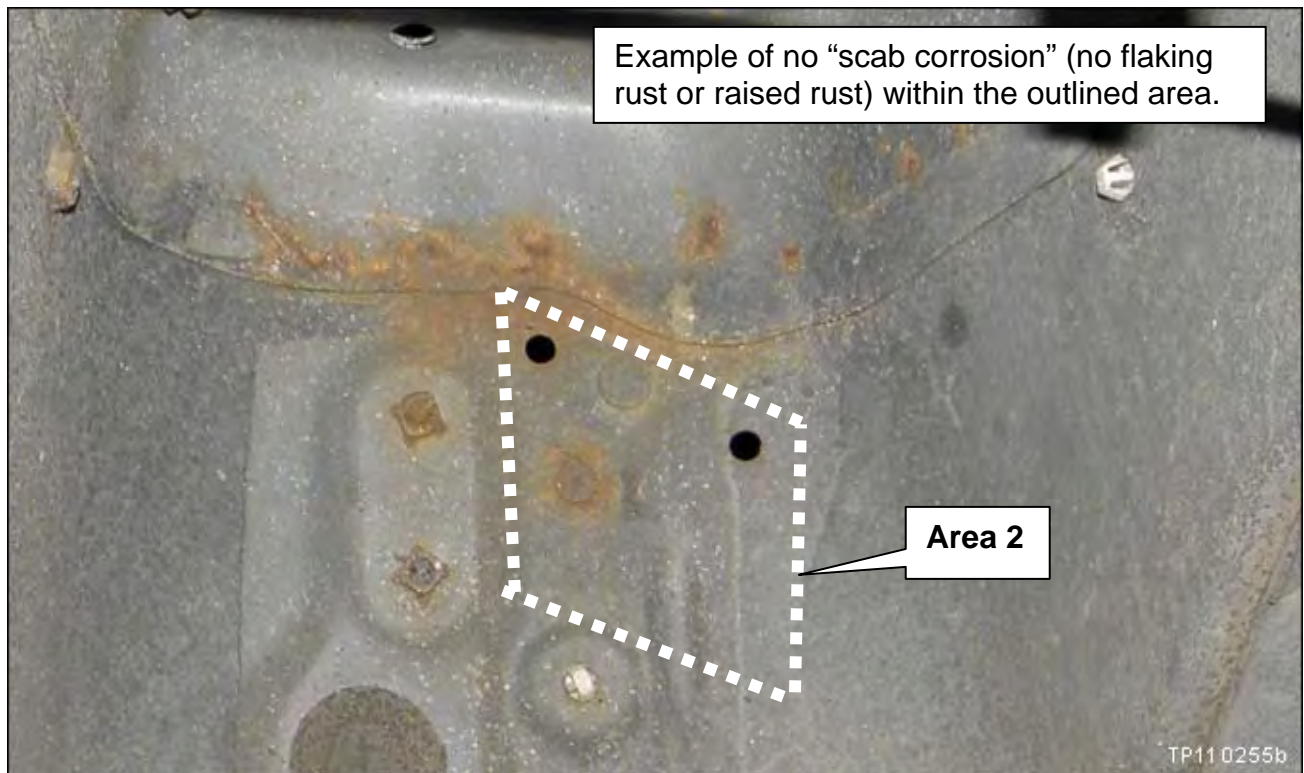

Figure 4

**Area 2:** Look for “scab corrosion” (flaking rust or raised rust) only in the area outlined above.

**NOTE:** If needed, refer to example (additional photo) of area 2 scab corrosion inspection on page 48.

Figure 5 is an example of “scab corrosion” (flaking and raised rust).



Figure 5

If there is **scab corrosion** (flaking or raised rust) in area 2:

- a. Retain the vehicle at the dealer. (The vehicle is not repairable.)
- b. Supply the customer with a rental car.
- c. Fax a completed Non-Repairable Report to Morley (see page 55).

If there is **no scab corrosion** (no flaking or raised rust) in area 2:

- Go to Determine Repair Level For Passenger Side on the next page.

**NOTE:** If there is no perforation in Area 1 and no scab corrosion in Area 2, the vehicle is “repairable”.

### Determine Repair Level for Passenger Side

**NOTE:** At this point in the procedure the vehicle should have been deemed “repairable”. If needed, refer to Determine if Vehicle is Repairable on page 6.

1. Remove the front passenger side wheel.
2. Use mild soap, water, and a brush to **thoroughly wash** the strut housing and the wheel housing in the area shown in Figure 6.



Figure 6

3. Visually inspect for corrosion and rust on the wheel housing panel and the strut housing panel.
  - Inspect for corrosion and rust on the panels only.

**NOTE:** Corrosion or rust on the strut or other suspension components is not covered by this campaign.

### Possible Repair Levels for Passenger Side

	Use Level 1 Repair If:	Use Level 2 Repair If:
Passenger Side *	No perforation (page 38)	Perforation (page 40)

\* Refer to a summary of each repair level on the next page.

## Summary of Repair Levels

### Driver Side

Significant rust on strut housing or wheel house panels (vehicle was deemed repairable)

- Remove the strut.
- Use an abrasive tool to remove loose corrosion and rust.
- Apply self etching primer.
- Install the repair bracket.
- Patch perforated areas – if needed.
- Apply rubberized undercoating.

Page 12

### Passenger Side

#### Level 1 – No perforation

- Use an abrasive tool or scraper to remove rust.
- Clean wheel housing and strut housing area.
- Apply self etching primer.
- Apply rubberized undercoating.

Page 38

#### Level 2 – Perforation

- Use an abrasive tool to remove loose corrosion and rust.  
(Only if needed, remove the strut to access perforated area.)
- Apply self etching primer.
- Patch perforated areas.
- Apply rubberized undercoating.

Page 40

## DRIVER SIDE REPAIR

### Front Strut Removal

#### NOTE:

- Use care during strut removal to prevent stress on electrical, hydraulic, and mechanical components.
- If needed; spray the strut mounting bolts/nuts with Nissan Rust Penetrant (P/N 999MP-A3020P) or equivalent.

1. Support the transverse link (lower control arm) with a jack stand as shown.
  - a. Position the jack stand under the lower control arm.
  - b. Lower the vehicle until the lower control arm touches the jack stand.

**NOTE:** Do not lower the vehicle beyond just touching the jack stand. Do not put tension on the coil spring.



Figure SR1

2. Disconnect the following items:
  - Remove clip and take brake hydraulic line loose from support.
    - Discard clip, use new clip for reassembly.
  - Remove bolt for ABS sensor harness support.
  - Take ABS sensor harness loose from support on the other side of strut (not shown).
  - Remove lower strut bolts.
    - Discard the nuts, use new ones for reassembly.

**NOTE:** Do not remove the nuts from the stabilizer connecting rod.

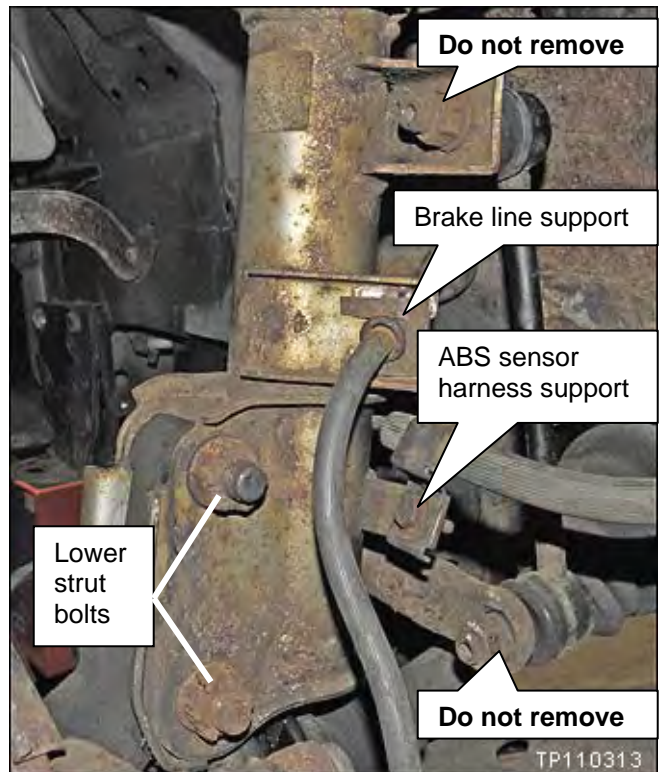

Figure SR2

3. **Carefully** separate the knuckle from the strut.

**NOTE:** Do not let the knuckle fall away from the strut. This will cause the weight of the knuckle assembly to pull on the brake line and the driveshaft boot (if equipped).

4. Use an elastic strap or other suitable tool to secure the knuckle to the stabilizer bar as shown.

**NOTE:** Make sure the knuckle assembly is secure. Its weight must be supported during the entire repair process.



Figure SR3

5. Remove the 2 bolts for the ABS sensor connector cover.

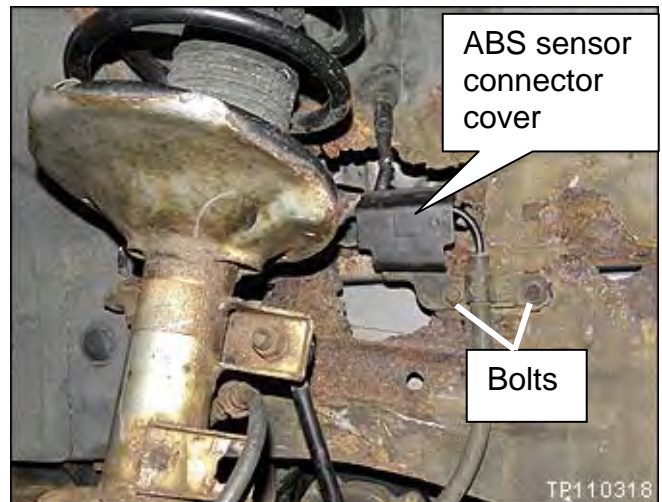

Figure SR4

6. Disconnect the ABS sensor connector.

- ABS sensor connector is on the back side of the cover.

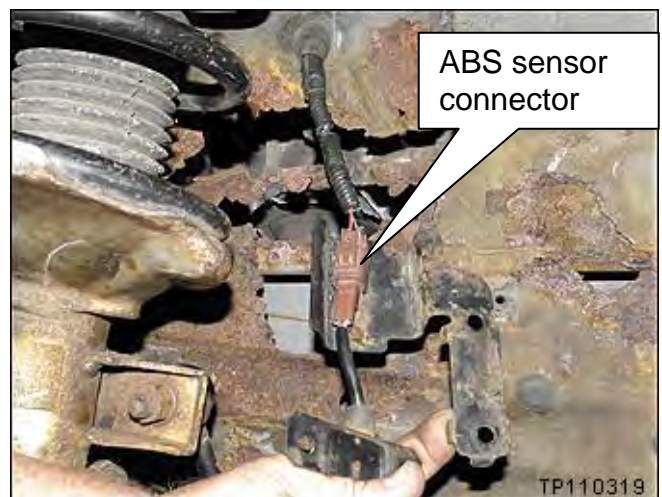

Figure SR5

7. Pull the ABS sensor harness from behind the strut.

8. Let the ABS sensor harness hang out of the way as shown.



Figure SR6

9. Raise the vehicle enough so the lower control arm is not touching the jack stand.

10. Remove the 3 upper strut mounting nuts.

- Discard the nuts, use new ones for reassembly.

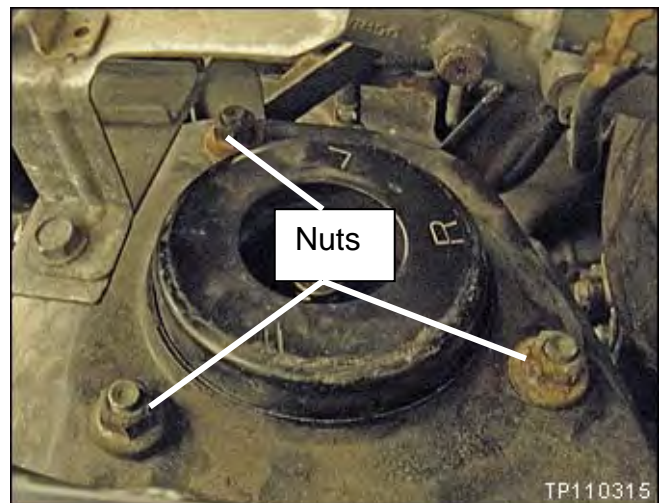

Figure SR7

11. Maneuver the strut so it is hanging upside down as shown.

**NOTE:** The weight of strut is supported by the stabilizer connecting rod.



Figure SR8

## Repair Bracket Installation for Driver Side Strut Housing

(Driver side repair continued)

**WARNING:** Perform repairs in a well ventilated area.

**NOTE:**

- Plastic covers (fender protectors) in the wheel house area do not need to be removed.
- For 4WD vehicles: If the driveshaft boot is ripped, it should be covered to prevent debris from entering the driveshaft joint.

1. Inspect the ABS sensor harness for damage. If damaged, repair as necessary.
2. Push the ABS harness and connector through the panel.
  - The harness/connector will now be out of the working area.

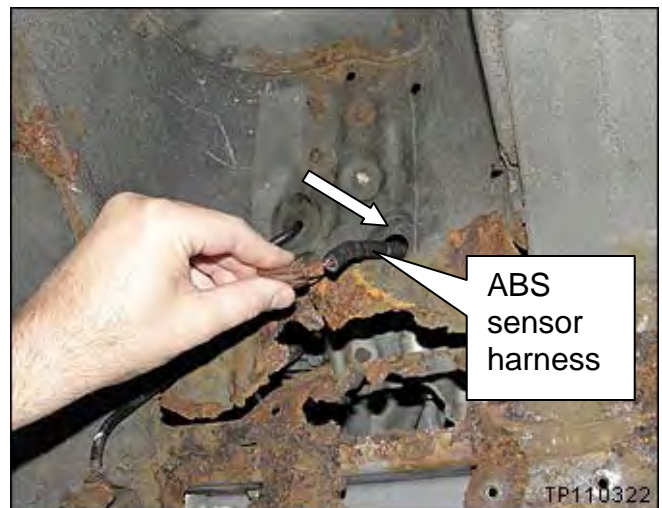

Figure RB1

3. Use a scraper bar to scrape off loose flaking rust and corrosion.



Figure RB2

4. Clean all the loose rust from the strut housing and wheel house areas (see Figure RB3).
  - Use an abrasive pad or other suitable tool.

**NOTE:** If the brake line is in the way of the area that needs to be cleaned, remove it from the mount and move it out of the way.



Figure RB3

5. **From under the hood**, remove the air filter box and the air intake duct from the filter box to the engine.



6. Inspect the steering column upper joint (steering shaft) in the area circled in Figure RB4.

Check for rubbing/contact with the strut housing panel.

Contact may have occurred if the strut housing separated from the wheel house.

- **ONLY if the E-coat has been rubbed through to bare metal**, the steering shaft will need to be replaced.
- If the steering shaft needs replacement, you will be instructed to replace it later in this procedure.

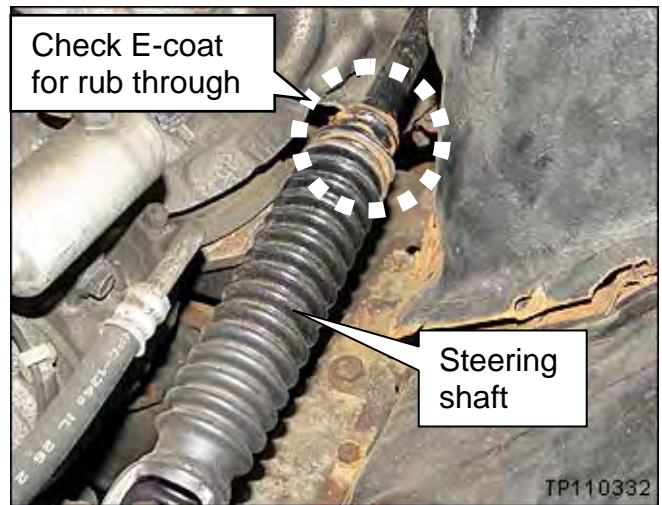

Figure RB4

7. Only if the strut housing panel is separated as show in Figure RB5:

Use a wire brush to clean any loose rust, paint, or other debris from the area shown with dashed line.



Figure RB5

8. Use low pressure compressed air to blow off dust and debris:

- From the under hood side of the strut housing panel and the surrounding area, and
- From the wheel house area.

9. Use isopropyl alcohol to clean/wipe down the area:

- If the strut housing panel was separated, clean/wipe down the under hood side of the strut housing panel and the surrounding area.
- Clean/wipe down the wheel house area.

10. Only if the strut housing panel is separated:

Completely and liberally coat the strut housing panel (in the area shown with dashed line) with self etching primer.

- Use Dupont Etch Primer (P/N A-4119S™) or equivalent.
- Follow all product instructions.
- A second coat may be needed for heavy rust spots.
- Let each coat dry for 5 minutes.

**NOTE:** Refer to the Parts Information for additional product details.

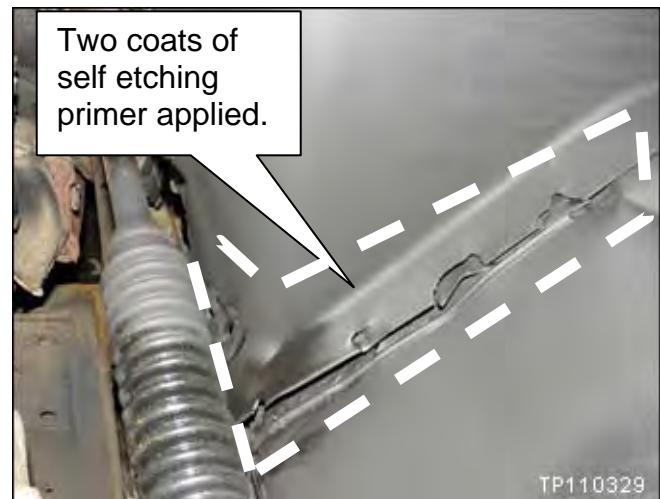

Figure RB6

11. Completely and liberally coat the strut housing and wheel house area with self etching primer (see Figure RB7).

- Use Dupont Etch Primer (P/N A-4119S™) or equivalent
- Follow all product instructions.
- Coat all of the exposed metal areas on the strut housing and wheel house panels.
- A second coat may be needed for heavy rust spots.
- Let each coat dry for 5 minutes.

**NOTE:** Refer to the Parts Information for additional product details.

12. Locate the two existing holes at the upper area of the strut housing panel (see Figure RB7).

13. With a drill bit, enlarge these two existing holes to 10 mm (3/8 in).

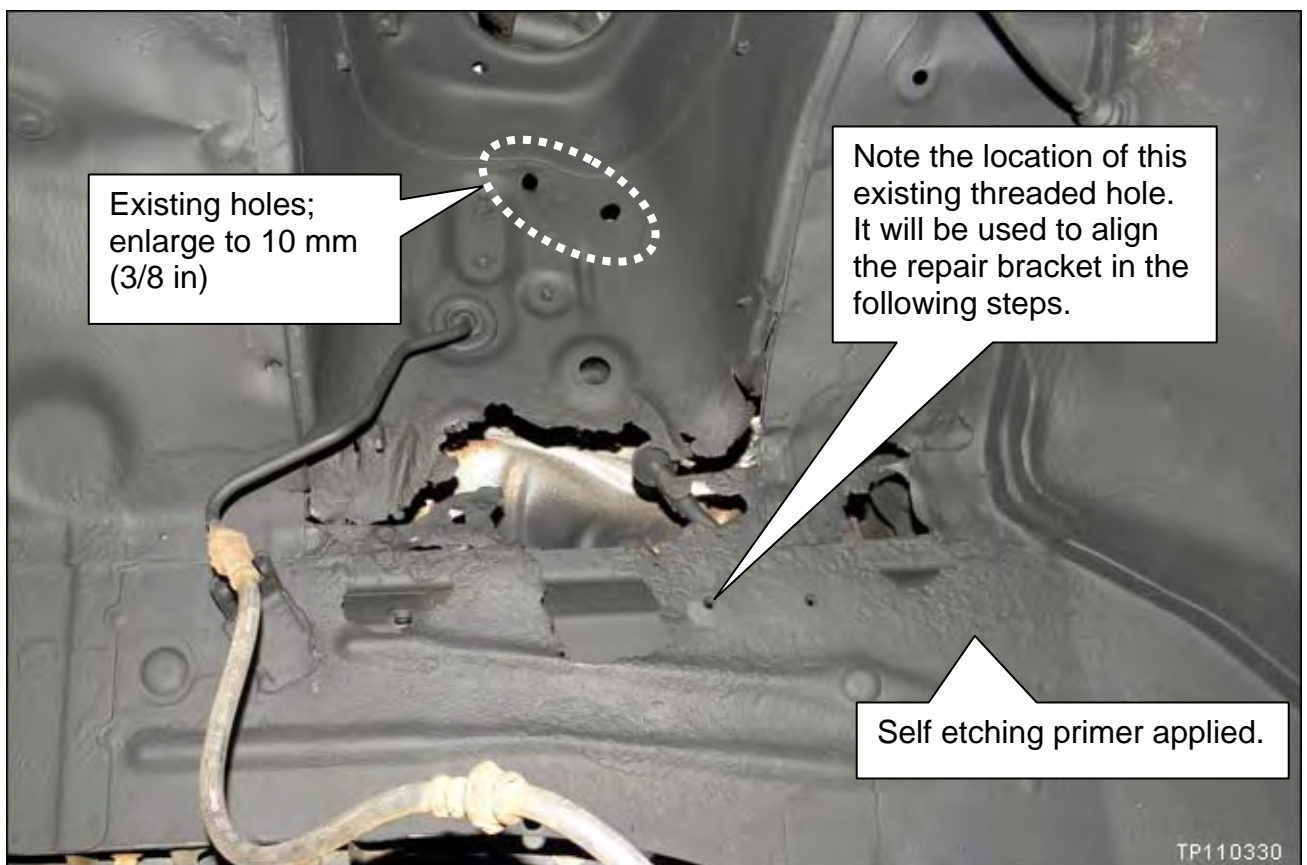

Figure RB7

14. Attach the repair bracket to the existing holes that you enlarged (see Figure RB8).

- Repair bracket is part of the Repair Kit listed in the Parts Information.
- Use bolts and hex nuts from the Repair Kit.
- Tighten the bolts/nuts finger tight.

15. **Only if the strut housing panel is separated:**

- a. Attach the ratchet strap as shown in Figure RB8.
- b. Use the ratchet strap to pull the strut housing panel until the existing threaded hole is aligned with the matching hole in the repair bracket (see Figure RB8).

16. Install a bolt in the existing threaded hole and make it finger tight.

17. Align the bottom edge of the repair bracket with the edge of the body frame.

- The bracket will have some movement in all directions. Move it (align it) the best possible.

18. Once the bottom edge is aligned, securely tighten the 3 bolts.

- Bolts need to be tight enough to hold the bracket in place while you center punch and drill holes in the next step.

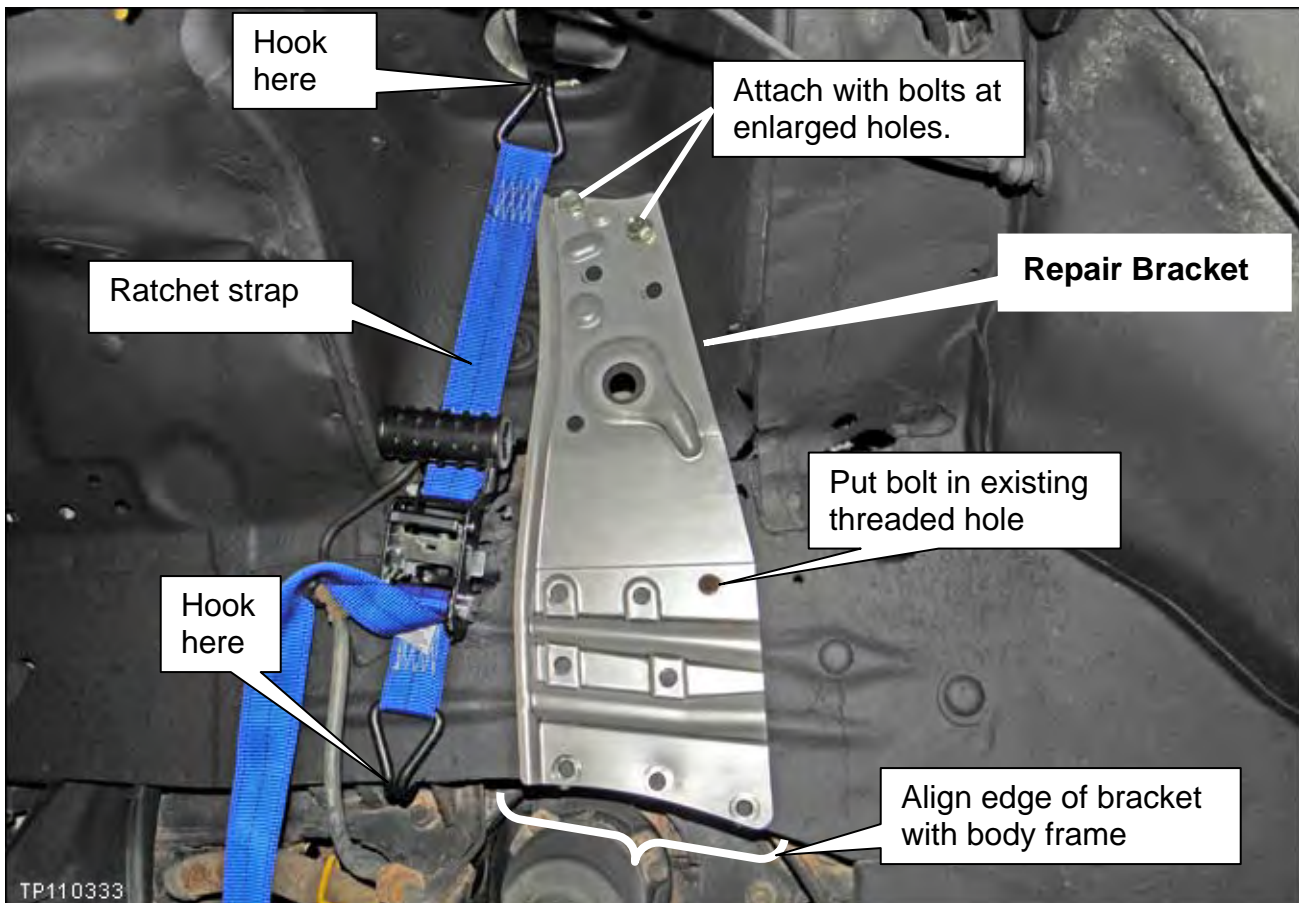

Figure RB8

**NOTE:** Photos for installation of the repair bracket show the ratchet strap being used. In most cases the strut housing panel will not be separated and the ratchet strap will not be needed.

19. Drill the 10 holes marked in Figure RB9 to **10 mm (3/8 in)**.

- a. Center punch the holes.
- b. Pilot drill with a 1/8 drill bit.
- c. Drill holes to **10 mm (3/8 in)**.

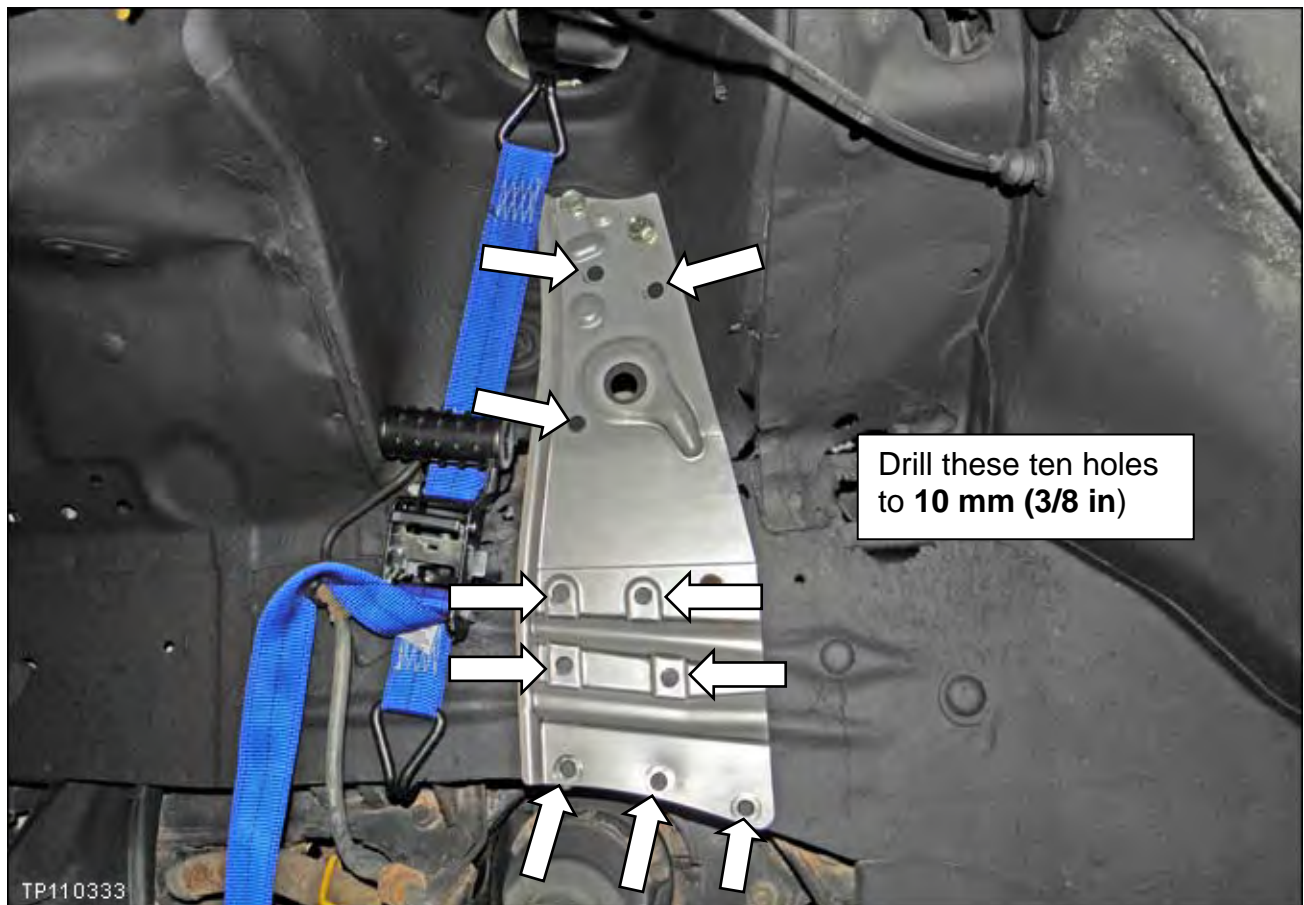

Figure RB9

20. Remove the repair bracket.

21. For the 4 holes that will have Rivet Nuts installed, drill final hole size to **13.1 mm (33/64 in)**. See Figure RB10.

**NOTE:** Each dealer was shipped, at no charge, one 33/64 drill bit (J-50878).

22. Install Rivet Nuts in the 13.1 mm (33/64 in) holes (see Figure RB10).

- Refer to Rivet Nut Installation Instructions on the next page.

**IMPORTANT:**

- **Lower holes - Required:** Rivet Nuts are required in the lower holes (indicated with dashed line in Figure RB10).

If the metal in the area of the lower holes will not support the Rivet Nuts, then the vehicle is “not repairable”: Retain the vehicle at the dealer, supply the customer with a rental car, and Fax a completed Non-Repairable Report to Morley (see page 55).

**NOTE:** Upper holes – not required: If the metal in the area of the upper holes will not support Rivet Nuts, continue with the repair. Rivet Nuts are preferred but not required in the upper holes.

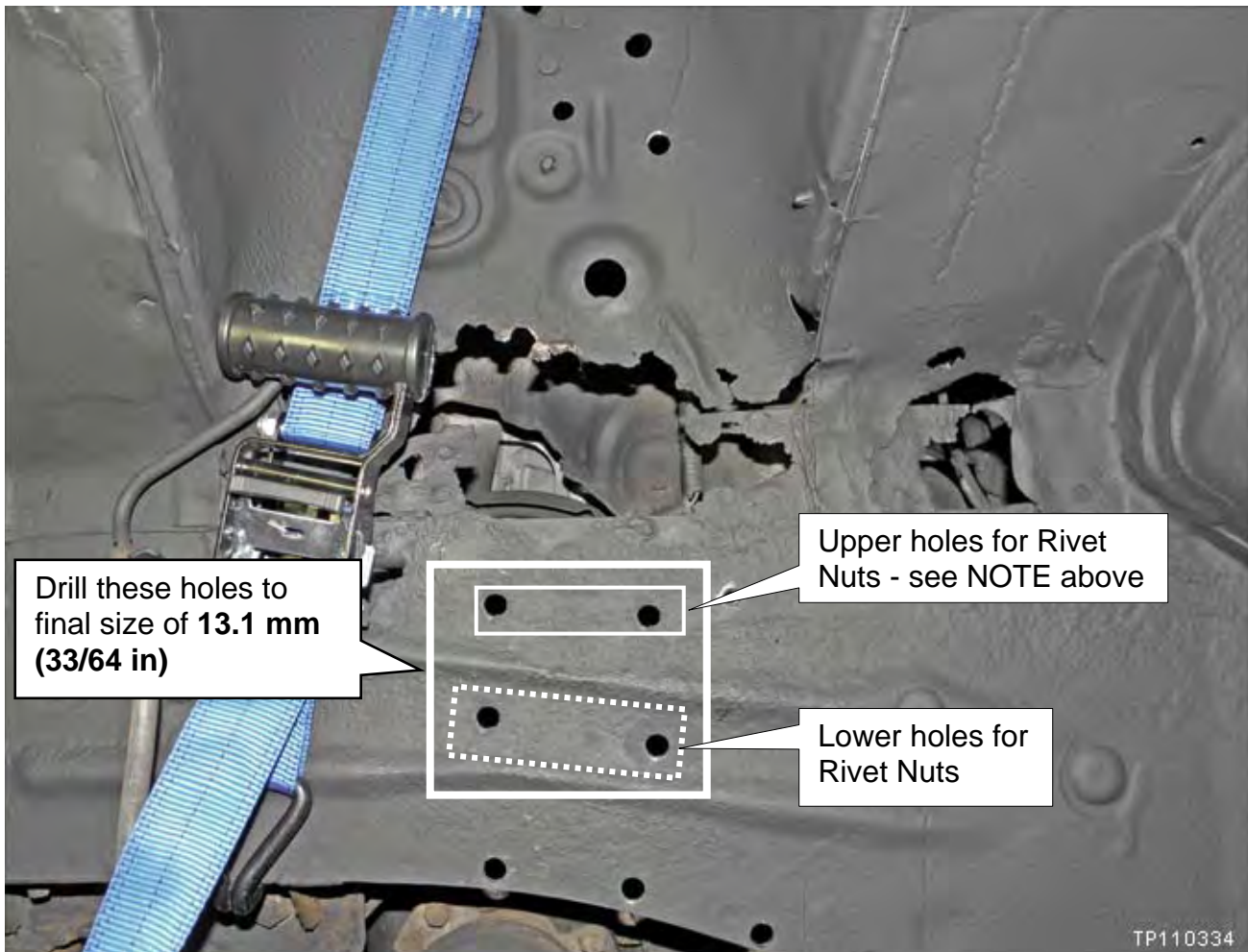

Figure RB10

## Rivet Nut Installation Instructions

**NOTE:** First time use:

- The rivet gun is shipped with a collapsed Rivet Nut installed on the mandrel.
- Remove the collapsed Rivet Nut and discard.

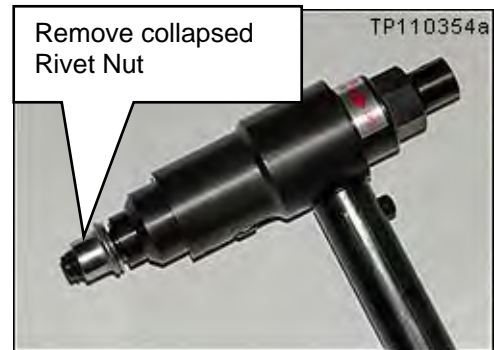

Figure RB11

- A. Turn the hex nut on the rivet gun counterclockwise until it stops (turn to “Set” position).

**NOTE:** See label on tool.

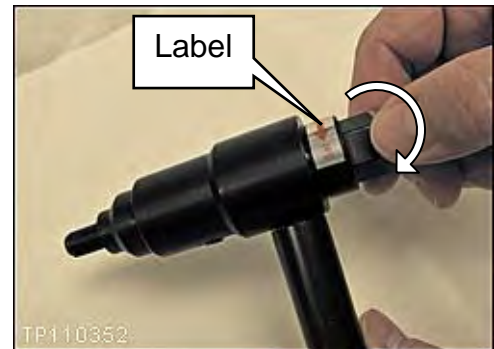

Figure RB12

- B. Screw a new Rivet Nut onto the mandrel.



Figure RB13

C. Turn the rear knob clockwise until it stops.

**NOTE:** Turning the rear knob sets (screws) the Rivet Nut all the way onto the mandrel.



Figure RB14

D. Turn the hex nut clockwise until it stops, about ½ turn (turn to “Fasten” position).

**NOTE:** See label on tool.

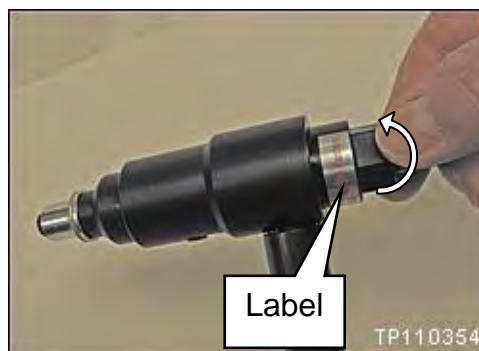

Figure RB15

E. Place the Rivet Nut into the 13.1 mm (33/64 in) hole.



Figure RB16



F. Hold the tool at a right angle to the hole.

G. Use a 19 mm wrench to turn the hex nut clockwise  $2\frac{1}{2}$  to  $2\frac{3}{4}$  turns.

- Use the mark (white dot) on top of the hex nut to keep track of the number of turns.



Figure RB17

H. Turn the hex nut about  $\frac{1}{2}$  turn counterclockwise to release the mandrel tension.



Figure RB18

I. Turn the rear knob counterclockwise to remove (unscrew) the mandrel from the Rivet Nut.



Figure RB19

23. Reinstall the ABS sensor harness in its hole.

- Make sure the rubber grommet is in place.

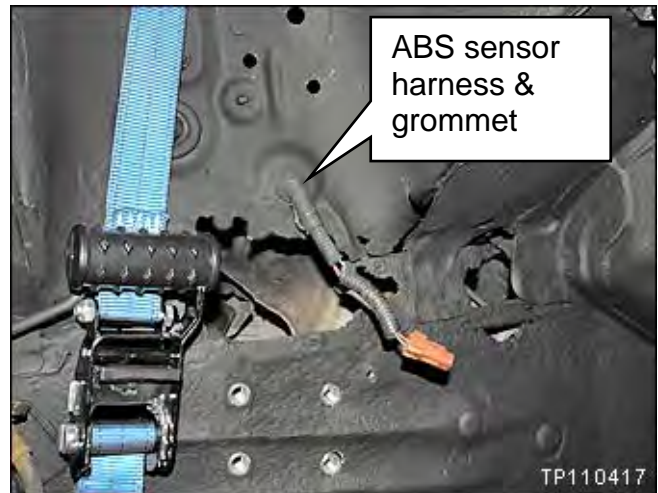

Figure RB20

24. Prepare for application of LORD Fusor® 108B (P/N 999MP – 108BP) structural adhesive (see Figures RB21 and RB22).

- a. Load cartridge of Fusor® 108B into the 2:1 dispensing gun.
  - b. Remove the cartridge cap and plugs (if this is the second use, remove the old nozzle).
  - c. Dispense/expel some material to make sure any hardened material is removed.
  - d. Install a **new** mixing nozzle onto the cartridge.
- Make sure the nozzle retainer is installed (see Figure RB21).

**NOTE:**

- Mixing nozzles are one-time use only. Do not reuse mixing nozzles.
- Two mixing nozzles are included with each cartridge of Fusor® 108B.
- Refer to the Parts Information for additional product details.
- For cleanliness, using rubber gloves is recommended.

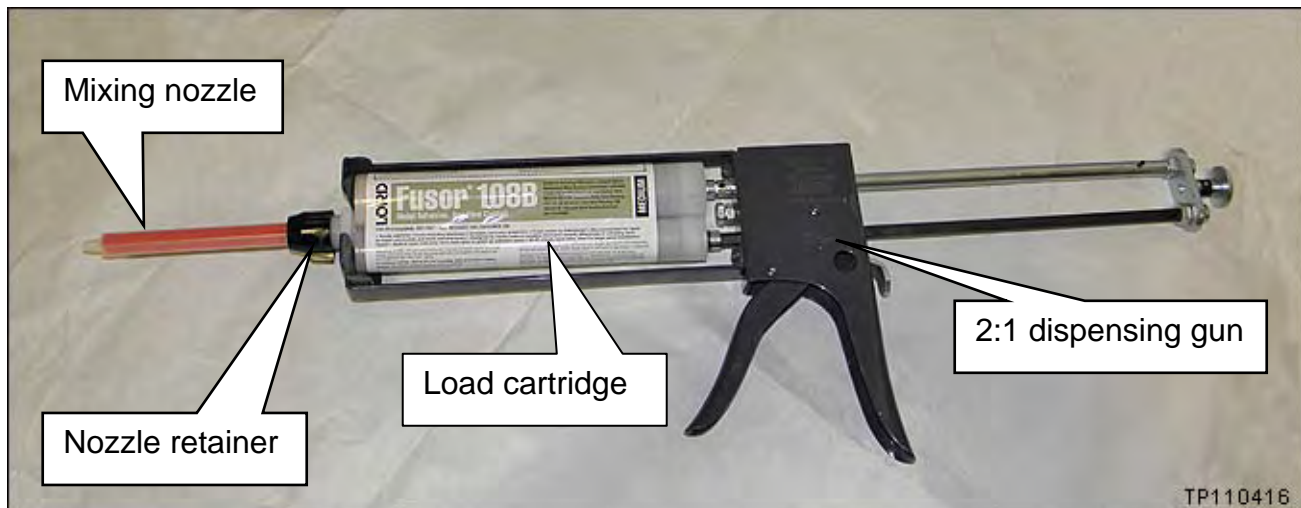
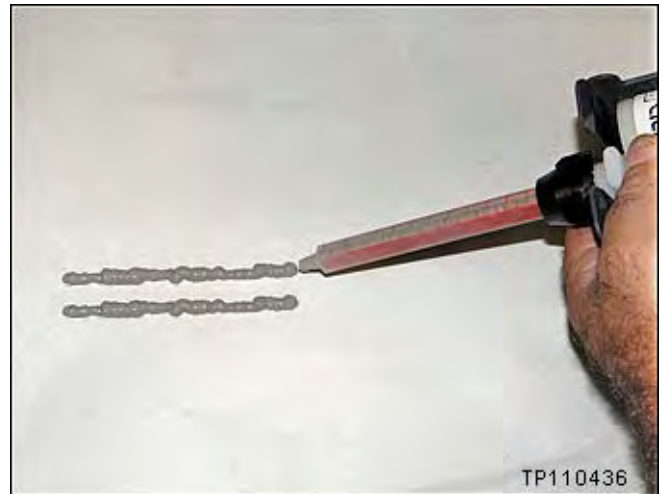

Figure RB21

c. Dispense 2 beads of Fusor® 108B onto a paper that will be discarded.

- Each bead should be about ¼ inch diameter and about 6 inches long (length of the nozzle).

**NOTE:** Performing this action will ensure the dispenser plungers have leveled, air bubbles have been expelled, and adhesive is mixed correctly.



RB22

25. Liberally apply Fusor® 108B to the back side of the repair bracket as shown.

- The adhesive bead should be about ¼ diameter in all the areas shown.

**NOTE:** Filling the two channels with 3 beads will ensure good adhesion in the channel area.

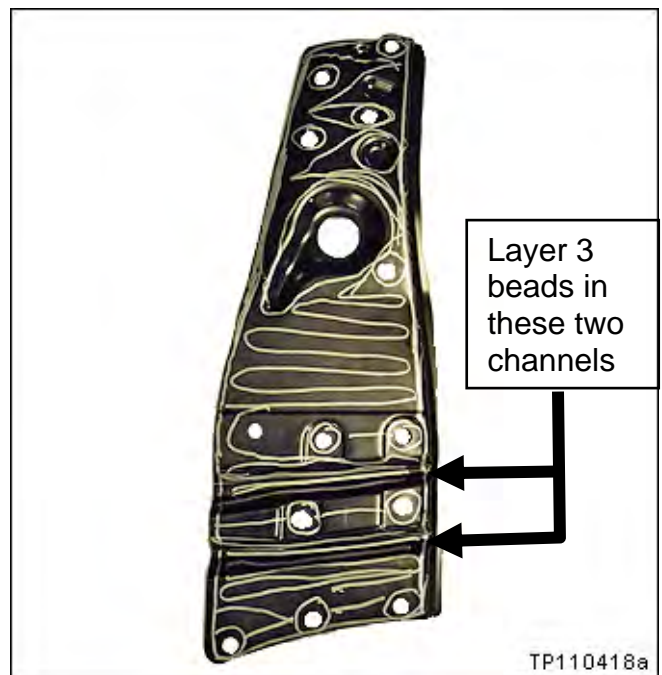

Figure RB23

**NOTE:**

- Each cartridge of Fusor® 108B has enough material to install two repair brackets.
- Leave the nozzle attached to the cartridge between applications. The nozzle will keep the cartridge sealed until the next use.

26. Bolt the repair bracket into place.

- Make sure the ABS harness is pulled through its hole (see Figure RB24).
- Use the correct nuts (see Figure RB24).
- **Do not use air tools to tighten the bolts.**
- Torque all bolt/nuts to 50 N•m (5.1 kg-m, **37 ft-lb**).

27. Make sure adhesive is cleaned from the existing threaded hole (see Figure RB24).

**NOTE:** This hole is used to mount the ABS sensor connector cover.

28. If the ratchet strap was used, carefully remove it.

29. Clean excess adhesive from around the edges of the repair bracket.

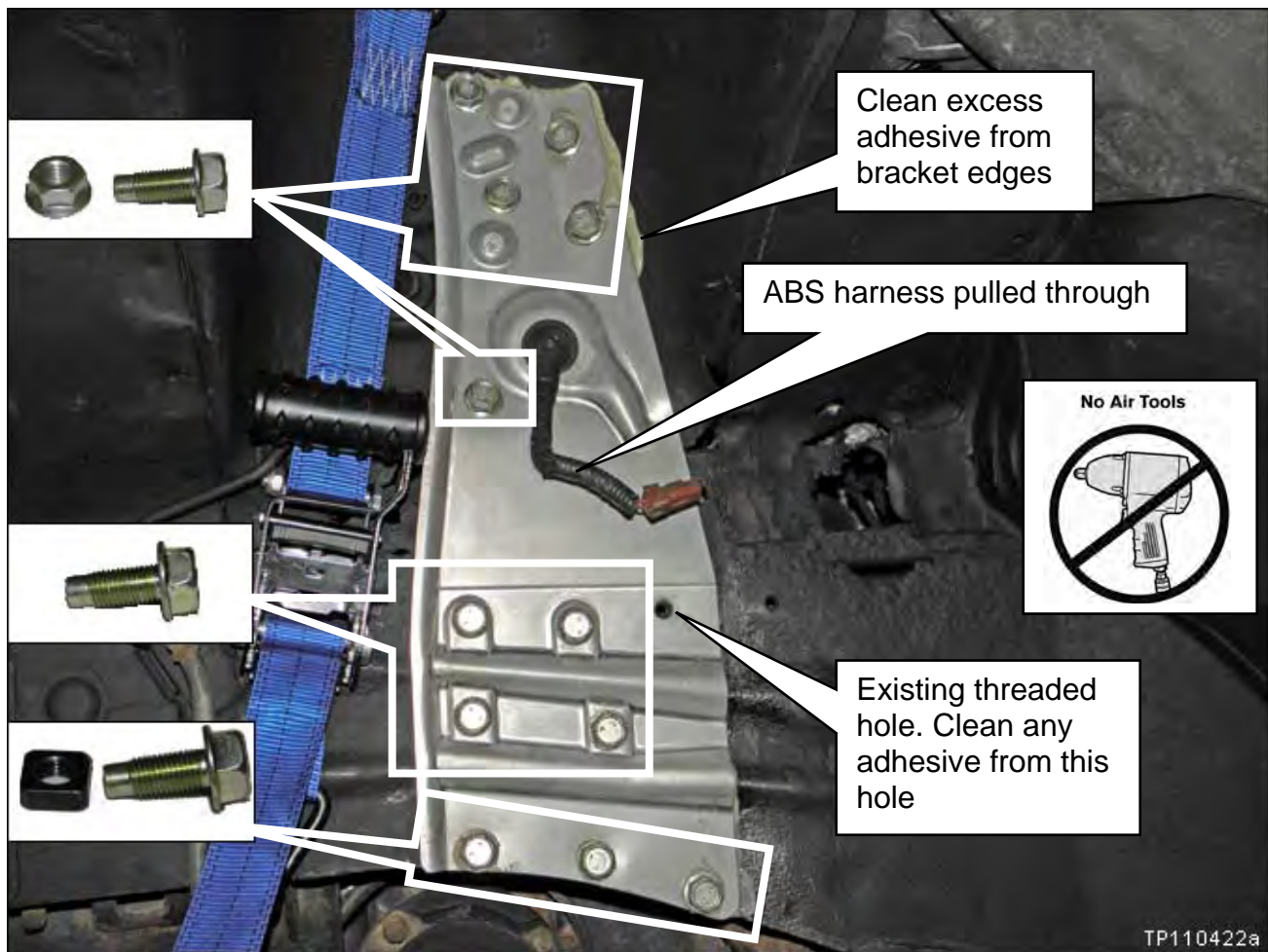

Figure RB24

**NOTE:** See additional repair bracket **bolt installation information** on the next page.

## Additional Bolt Installation Information

### Bolts that are preferred but not required (see Figure RB25):

- If these bolts do not have enough metal to support them (make them tight), use Lord Fusor® 108B to glue the bolts in the holes. **Do not leave open holes.** These bolts are preferred for bracket support, but not required.

### Bolts with Rivet Nuts that Must accept the torque (see Figure RB25):

- These bolts are required and must accept the torque value of 50 N•m (5.1 kg-m, **37 ft-lb**).
- If these bolts will not accept the specified torque value, the vehicle is not repairable:
  - a. Retain the vehicle at the dealer.
  - b. Supply the customer with a rental car.
  - c. Fax a completed Non-Repairable Report to Morley (see page 55).

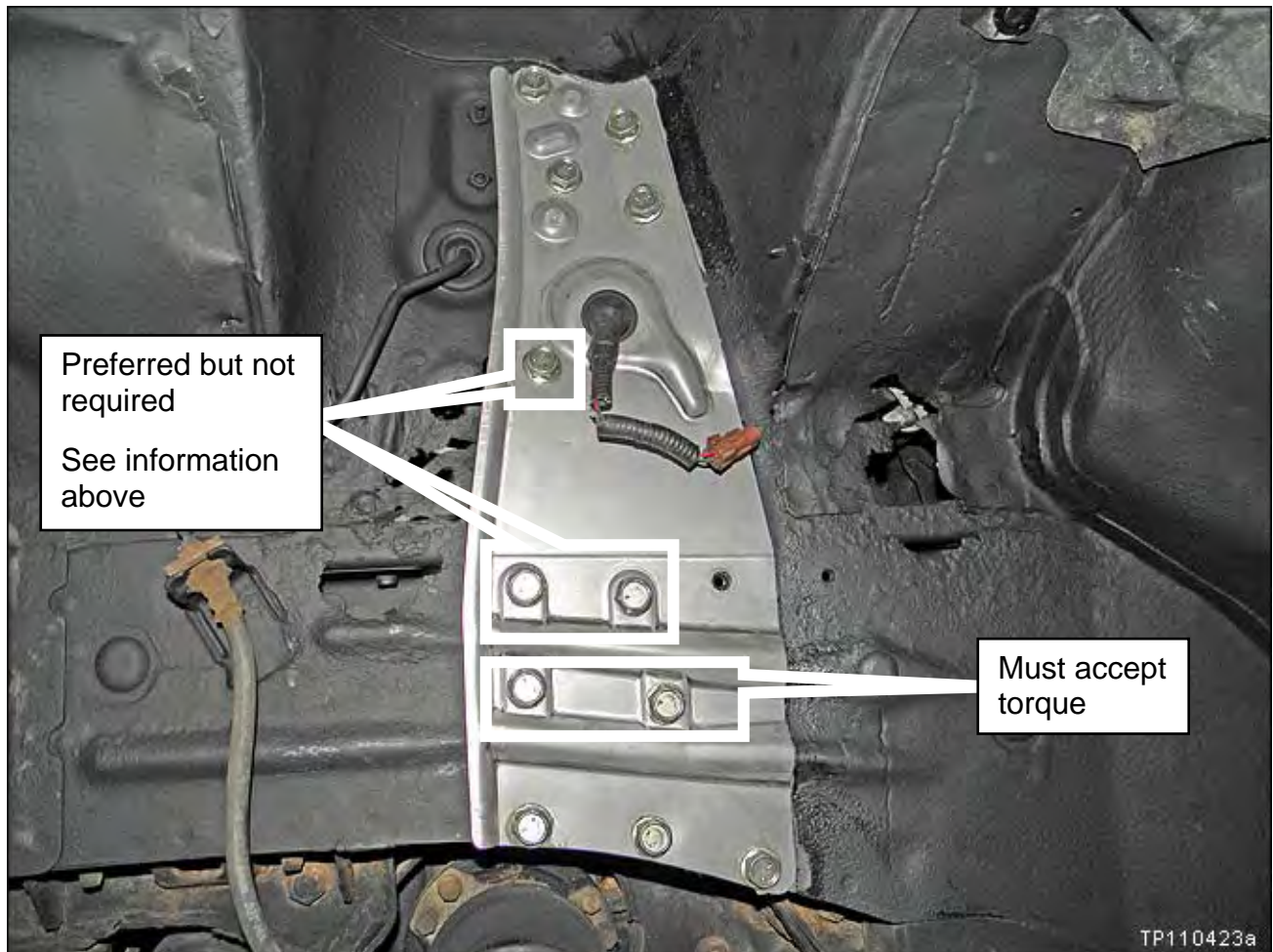

Figure RB25

30. Inspect the metal brake line for damage. If there is damage, replace the line.

- Inspect the line in the wheel house area (see Figure RB26).



Figure RB26

- Inspect the line under the hood (see Figure RB27)
- Scratches or nicks of the E-coat are not considered damage that requires brake line replacement.
- Refer to the appropriate Service Manual for brake line replacement information.

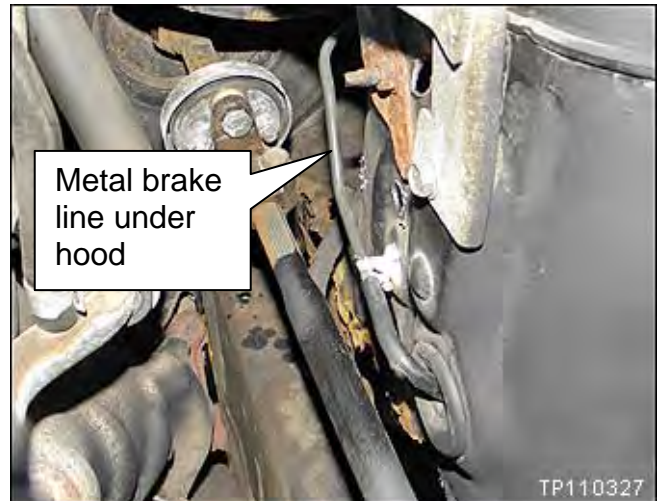

Figure RB27

31. If the strut housing was separated, inspect the brake master cylinder for damage.

Contact with the strut housing may have occurred if the strut housing separated from the wheel house.

- If there is damage, replace the master cylinder.
- Refer the appropriate Service Manual for brake master cylinder replacement information.



Figure RB28

## Patching Perforated Areas – driver side

**NOTE:** The Photo in Figure RB29 is an example of possible perforation. The vehicle you are working on may have perforation in additional areas, areas different than these, or may not have any perforation.

**If the vehicle you are working on does not have perforation, skip to step 35.**

32. Cut fiberglass cloth to cover perforated areas (see example in Figure RB29).

- Cut cloth to cover at least 1 inch beyond the perforation on all sides, except when the perforation is next to the repair bracket.
- Where perforation is next to the repair bracket, cut cloth to fit along the edge of the repair bracket.
- If there is more than one perforation, cut fiberglass cloth for each perforated area.
- Use 3M™ Bondo Fiberglass Repair Kit (P/N 422) or equivalent.
- Use protective gloves (such as rubber gloves or disposable gloves) while working with fiberglass and resin.
- Do not install fiberglass patch on or over the repair bracket.

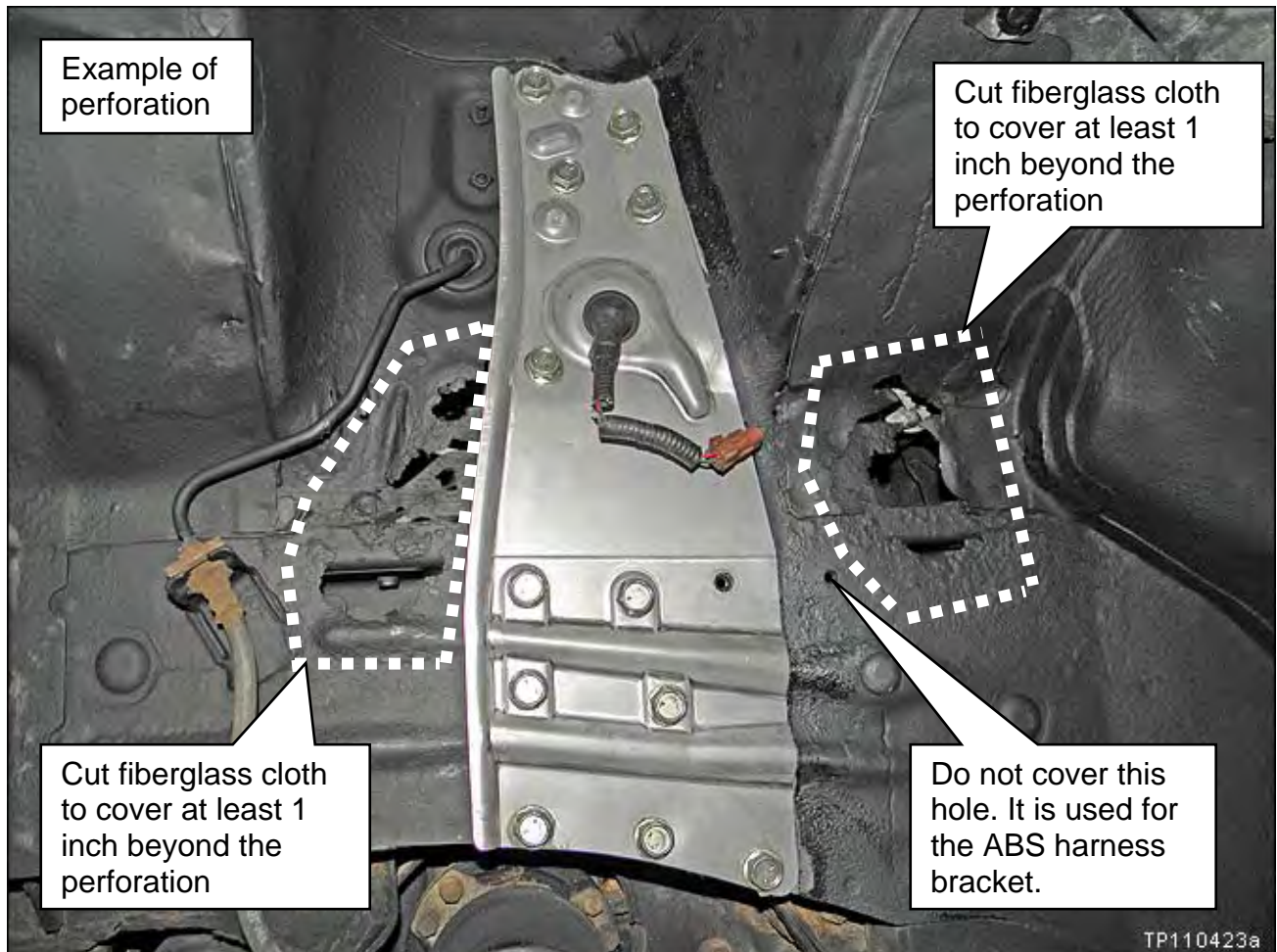

Figure RB29

33. Apply fiberglass patch to perforated areas.

- No additional surface preparation is needed.
  - Apply patch over the self etching primer.
  - Cleaning/grinding to bare metal **is not** needed.
- Use protective gloves (such as rubber gloves or disposable gloves) while working with fiberglass and resin.
- Follow all warnings and cautions for the fiberglass product being used.
- Follow the product instructions for applying the fiberglass patch.

**WARNING:** Perform repairs in a well ventilated area.

34. Allow the fiberglass patch and resin to harden before continuing (about 30 minutes).

35. Prepare for application of LORD Fusor® 800EZ (P/N 999MP – 9G000P) seam sealer.

- a. Load the cartridge into a 1:1 dispensing gun (see Figure RB30).
- b. Cut the tip at about ¼ inch diameter opening.

**NOTE:** Refer to the Parts Information for additional product detail.

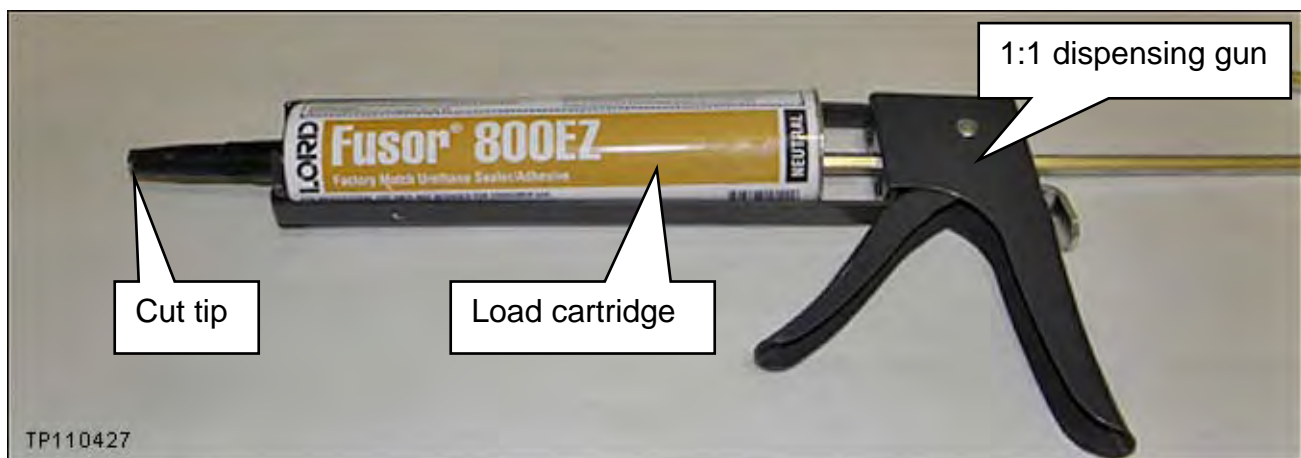

Figure RB30



36. Apply Fusor® 800EZ (seam sealer) as shown in Figure RB31.

- Apply around the outer edges of the repair bracket. Make sure all gaps are filled.
- Apply along the seams between the strut housing panel and the wheel house.
- Use a brush or other suitable tool to smooth the sealer for good seam coverage.
- Allow seam sealer to dry for 10-15 minutes.

37. Apply Butyl Sealer (P/N B6553 – 89915) around the opening for the ABS sensor harness (see Figure RB31).

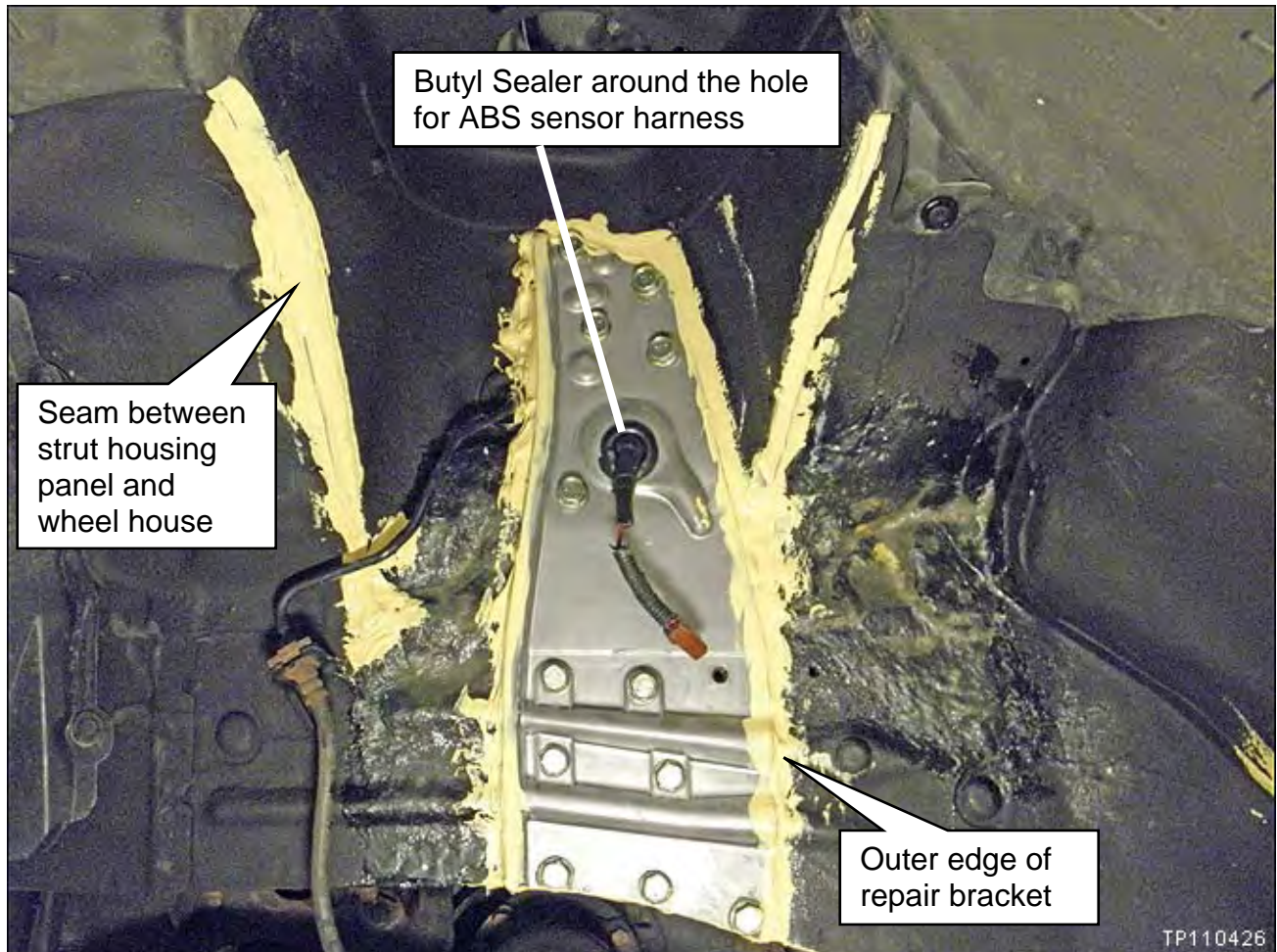

Figure RB31

38. Only if strut housing panel is separated:

Apply Fusor® 800EZ (seam sealer) as shown in Figure RB32.

- Apply along the front seam between the strut housing panel and the wheel house.
- Use a brush or other suitable tool to smooth the sealer for good seam coverage.
- Allow seam sealer to dry for 10-15 minutes.



Figure RB32

39. Completely and liberally coat the area shown in Figure RB33 (strut housing and wheel house area) with rubberized undercoat.

- Use 3M Rubberized Undercoating (P/N 051135 – 08883) or equivalent.
- Follow all product instructions.
- Coat all of the exposed metal areas on the strut housing and wheel house panels.

**NOTE:** Refer to the Parts Information for additional product details.

40. Inspect the ABS sensor harness covering – if needed use electrical tape to wrap the harness.

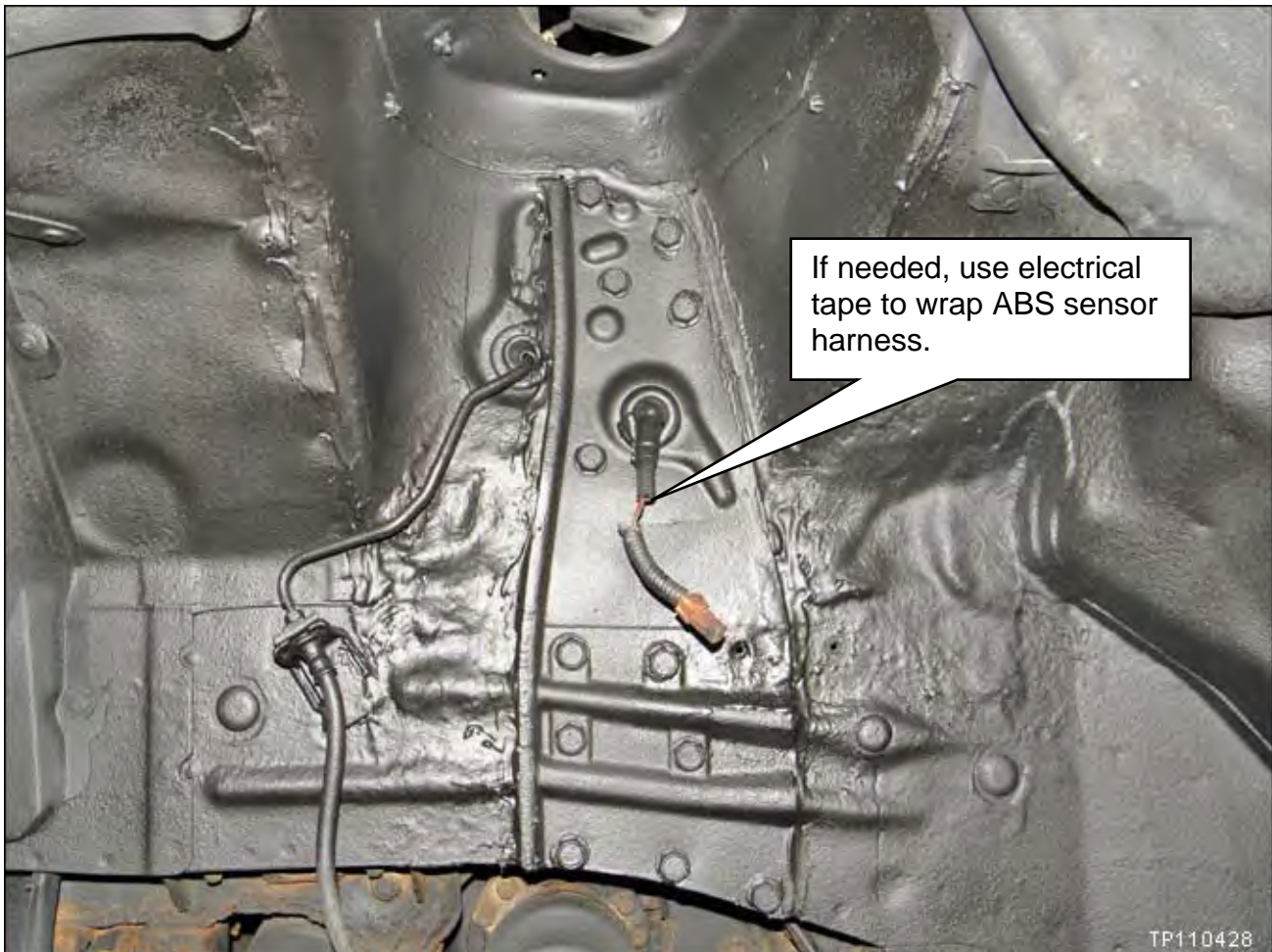

Figure RB33

41. Only if strut housing panel was separated:

Completely and liberally coat the area shown with dashed line in Figure RB34 with self etching primer.

- This is the under hood front of strut housing panel.
- Use Dupont Etch Primer (P/N A-4119S™) or equivalent.
- Follow all product instructions.



Figure RB34

**NOTE:** Refer to the Parts Information for additional product details.

42. If the steering shaft needs replacement, replace it at this time.

- Replace steering shaft **ONLY if the E-coat has been rubbed through to bare metal.**
- If needed, refer to steering shaft inspection, step 6 on page 17.
- Refer to Steering Shaft Replacement on page 43.

43. Reinstall the air intake duct and the air filter box.

44. Reinstall the strut in reverse order of removal.

- Use **new** nuts for the upper strut mount (P/N 01225 – 00231).
- Nut torque is:  
39-54 N•m (4.0 - 5.5 kg-m, **(29-40 ft-lb)**)



Figure RB35

- Use **new** nuts for the lower strut mount (P/N 54588 – ED00A).

**NOTE:** Reuse the original bolts.

- Torque is:  
151 – 165 N•m  
(15.4 – 16.8 kg-m, **111 – 122 ft-lb**)

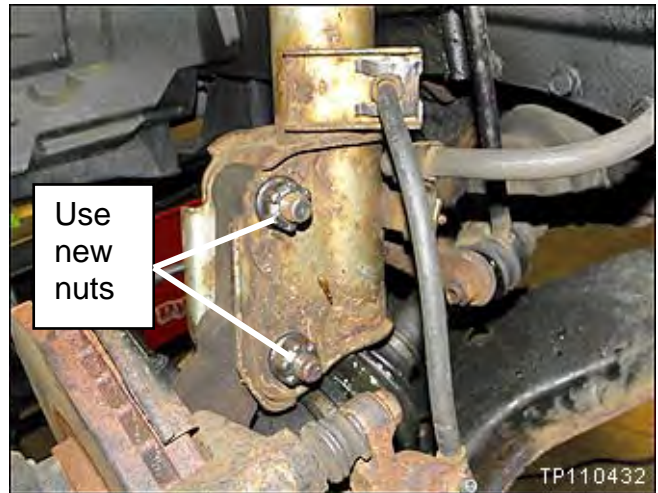

Figure RB36

- Use a new clip for the brake line mount (P/N 46206 – 2J00A).
- Confirm the ABS sensor harness is mounted correctly as shown in Figure RB37.
- Make sure the brake line is not twisted.

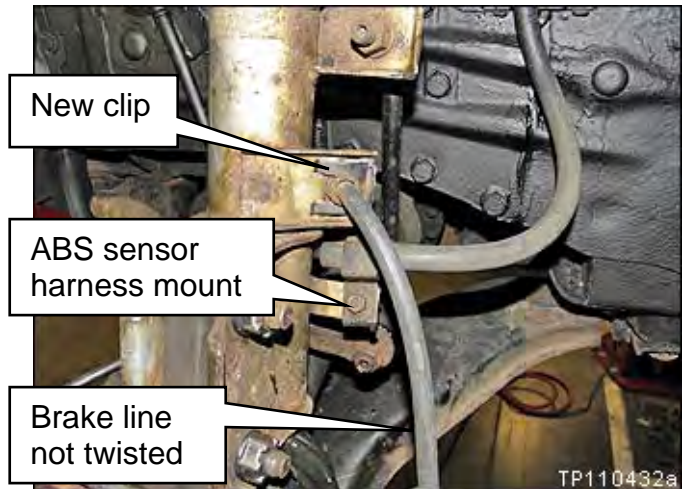

Figure RB37

- Use a new clip for the brake line mount (P/N 46206 – 2J00A).
- Make sure the brake line is not twisted.
- Confirm the ABS sensor harness is routed correctly behind the strut.
- Make sure the ABS sensor harness is mounted correctly as shown in Figure RB38.

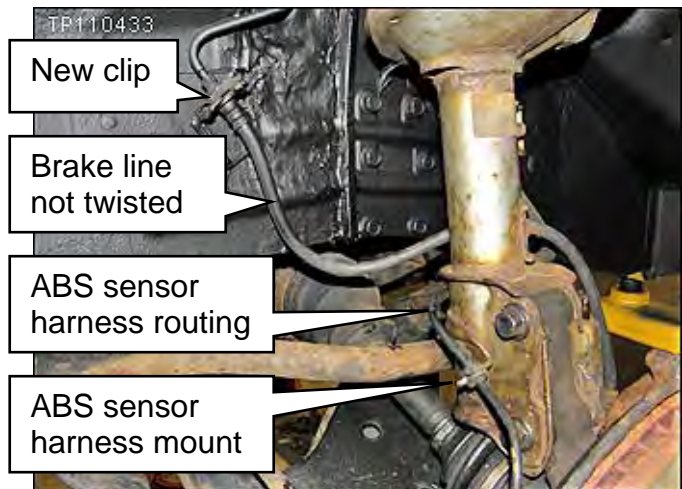

Figure RB38

- Make sure the ABS sensor harness connector cover is installed as shown.
  - If the cover is missing, install a new one.
  - Coat the cover with 3M Rubberized Undercoating (P/N 051135 – 08883) or equivalent, don't get any undercoat on the strut rod.

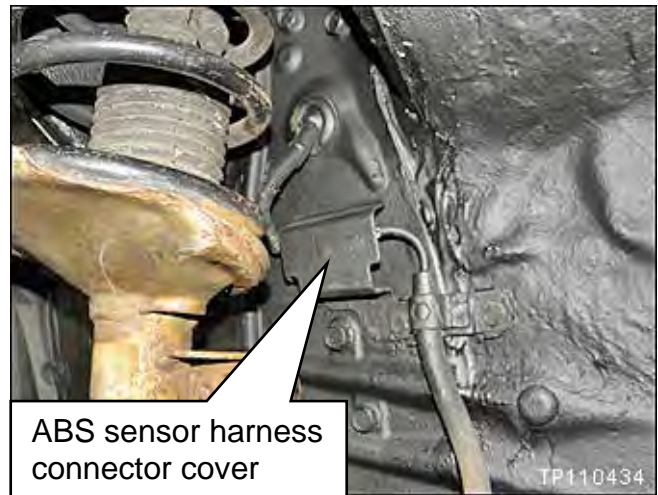

Figure RB39

#### 45. Reinstall the wheel.

- Torque for wheel nuts is 118 – 147 N•m (12 – 15 kg-m, **87 – 108 ft-lb**).

#### 46. Check and adjust the front wheel toe.

**NOTE:** Do not wash for 24 hours. This will allow time for the undercoat to completely cure before exposure to water.

## PASSENGER SIDE – LEVEL 1 REPAIR

No perforation in the strut or wheel house panels.

**WARNING:** Perform repairs in a well ventilated area.

### NOTE:

- Plastic covers (fender protectors) in the wheel house area do not need to be removed.
- For 4WD vehicles: If the drive shaft boot is ripped, it should be covered to prevent debris from entering the drive shaft joint.

1. Use a wire brush to remove loose rust in the area shown with dashed line.



Figure PS1

2. Clean dust, dirt, or other debris from the wheel house and strut housing area.

3. Cover the strut so it is protected from overspray.

4. Completely and liberally coat the strut housing and wheel house area with self etching primer.

- Use Dupont Etch Primer (P/N A-4119S™) or equivalent.
- Follow all product instructions.
- Coat all of the exposed metal areas on the strut housing and wheel house panels.



Figure PS2

- A second coat may be needed for heavy rust spots.
- Let each coat dry for 5 minutes.

**NOTE:** Refer to the Parts Information for additional product details.

5. Completely and liberally coat the wheel house, and strut housing area with rubberized undercoat.
  - Use 3M Rubberized Undercoating (P/N 051135 – 08883) or equivalent.
  - Follow all product instructions.
  - Coat all of the exposed metal areas on the strut housing and wheel house panels.
  - Use a spray nozzle to spray the areas behind the strut and other hard to reach areas.



Figure PS3

**NOTE:** Refer to the Parts Information for additional product details.

6. Let the undercoat dry for about 1 hour before removing the strut cover.
7. Reinstall the wheel.
  - Torque wheel nuts to 118 – 147 N•m (12 – 15 kg-m, **87 – 108 ft-lb**).

**NOTE:** Do not wash the vehicle for 24 hours. This will allow the undercoat to cure completely before exposure to water.

## PASSENGER SIDE – LEVEL 2 REPAIR

**WARNING:** Perform repairs in a well ventilated area.

### NOTE:

- This repair is used **only** if there is metal perforation on the passenger side in the area show in Figure PS4.
- If there is no perforation, go to Level 1 repair on page 38.
- Plastic covers (fender protectors) in the wheel house area do not need to be removed.
- For 4WD vehicles: If the drive shaft boot is ripped, it should be covered to prevent debris from entering the drive shaft joint.



Figure PS4

1. Clean all loose rust from the perforated area and other areas in the wheel house, and strut housing.
  - Use an abrasive pad or other suitable tool.
  - **Only if necessary** to access the perforated area, remove the right front strut. Refer to Strut Removal on page 12.
2. Use low pressure compressed air to blow off dust and debris from the cleaned area.
3. Use isopropyl alcohol to clean/wipe down the area.



4. Completely and liberally coat the strut housing and wheel house area with self etching primer (see Figure PS5).
  - Use Dupont Etch Primer (P/N A-4119S™) or equivalent.
  - Follow all product instructions.
  - Coat all of the exposed metal areas on the strut housing and wheel house panels.
  - A second coat may be needed for heavy rust spots.
  - Let each coat dry for 5 minutes.

**NOTE:**

- If the strut has not been removed, cover the strut so it is protected from overspray.



Figure PS5

5. Cut a piece of fiberglass cloth to cover at least 1 inch beyond the perforation on all sides.
  - If there is more than one perforation, cut fiberglass cloth for each perforated area.
  - Use 3M™ Bondo Fiberglass Repair Kit (P/N 422) or equivalent.
  - Use protective gloves (such as rubber gloves or disposable gloves) while working with fiberglass and resin.
6. Apply fiberglass patch to the perforated area.
  - No additional surface preparation is needed.
    - Apply patch over the self etching primer.
    - Cleaning/grinding to bare metal **is not** needed.
  - Use protective gloves (such as rubber gloves or disposable gloves) while working with fiberglass and resin.
  - Follow all warnings and cautions for the fiberglass product being used.
  - Follow the product instructions for applying the fiberglass patch.

**WARNING:** Perform repairs in a well ventilated area.

7. Allow the fiberglass patch and resin to harden before continuing (about 30 minutes).
8. Completely and liberally coat the wheel house, and strut housing area with rubberized undercoat (see Figure PS6).
  - Use 3M Rubberized Undercoating (P/N 051135 – 08883) or equivalent.
  - Follow all product instructions.
  - Coat all of the exposed metal areas on the strut housing and wheel house panels.

**NOTE:**

- If the strut has not been removed, cover the strut so it is protected from overspray.
- Use a spray nozzle to spray the areas behind the strut and other hard to reach areas.



Figure PS6

9. Let the undercoat dry for about 1 hour before removing the strut cover (if used).
10. If the strut was removed, reinstall it in reverse order.
  - Use new nuts for the upper strut mounting (P/N 01225 – 00231).
  - Use new nuts for the lower strut mounting (54588 – ED00A).
  - Use new clips (lock springs) for the brake line mounting points (P/N 46206 – 2J00A).
  - Make sure the brake lines are not twisted.
  - Confirm the ABS sensor harness is mounted and routed correctly.
  - Make sure the ABS sensor connector cover is in place.
11. Reinstall the wheel.
  - Torque for wheel nuts is 118 – 147 N•m (12 – 15 kg-m, **87 – 108 ft-lb**).

**NOTE:** Do not wash for 24 hours. This will allow time for the undercoat to completely cure before exposure to water.

## STEERING SHAFT REPLACEMENT

**NOTE:** Replace the steering column upper joint (steering shaft) **only if needed**. Refer to steering shaft inspection, step 6 on page 17.

1. Make sure the front wheels are positioned straight ahead.

2. Remove the clamp bolts at each end of the steering column upper joint (steering shaft).

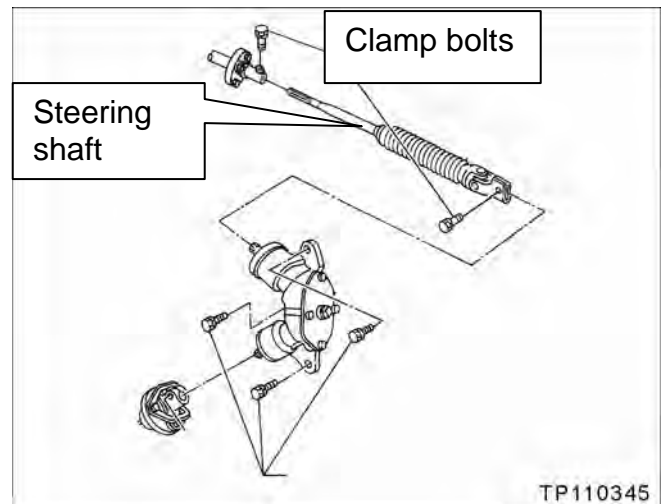

Figure SS1

3. Use a flat blade driver or other suitable tool to loosen **both** clamp ends of the steering shaft.

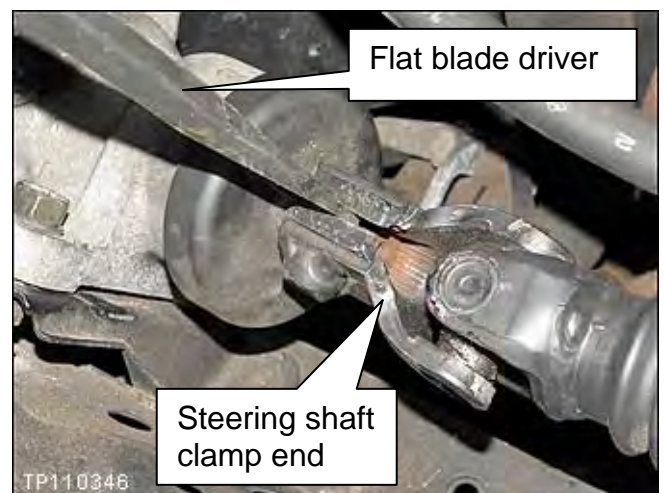

Figure SS2

4. Loosen the clamp ends enough so the steering shaft is loose at both ends.
  - Steering shaft will move back and forth a small amount.

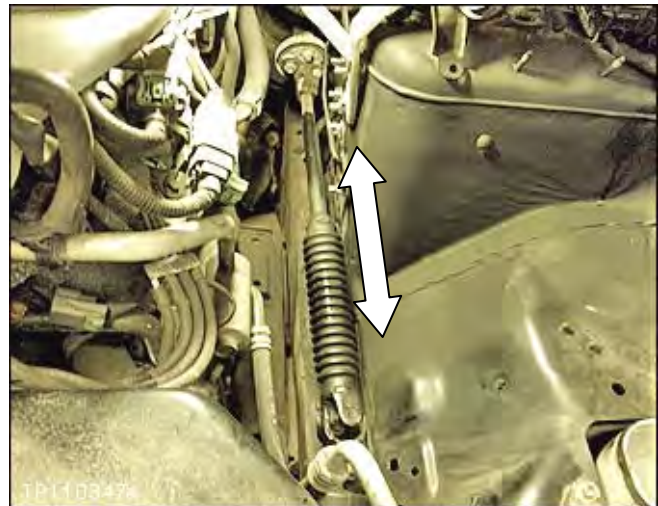

Figure SS3

5. Set the steering wheel in the straight ahead position.
6. Position a steering wheel holding tool as shown.
  - This will keep the steering wheel stationary while replacing the steering shaft.



Figure SS4

**NOTE:** The marks shown in Figure SS5 should be aligned.

- Tab on transfer gear assembly
- Raised area on rubber cover
- Gap on steering shaft clamp

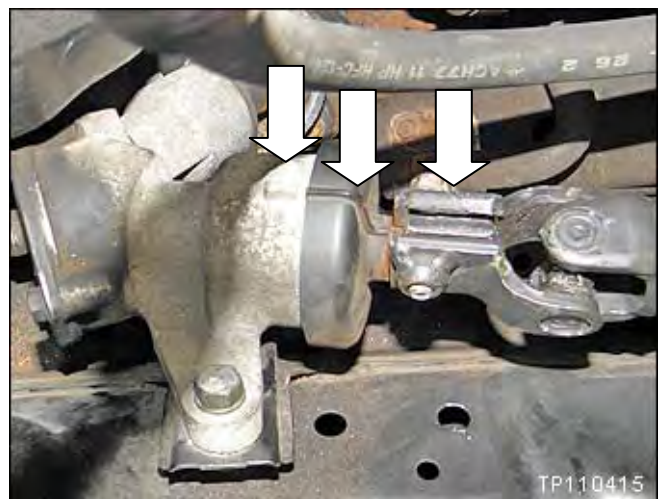

Figure SS5

7. Remove the 3 transfer gear assembly mounting bolts.

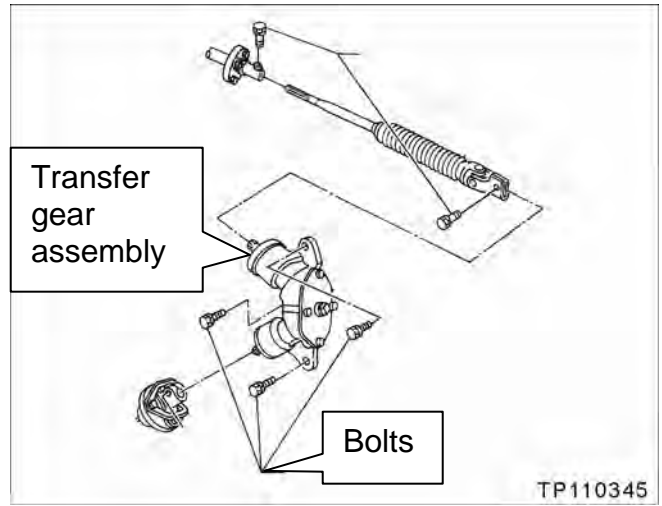

Figure SS6

8. Push the transfer gear assembly forward and remove the steering shaft.



Figure SS7

9. Pull the steering shaft to remove it from the other end.



Figure SS8

10. Install the new steering shaft in reverse order.

- The shaft end that goes towards the steering wheel is notched; it will go in only one way.
  - Make sure shaft end at the steering gear assembly is aligned correctly (see Figure SS5 on page 44).
  - Torque for steering gear assembly mounting bolts is:  
20 – 29 N•m (2.0 – 3.0 kg-m, **14 – 22 ft-lb**)
  - Torque for steering shaft clamp bolts (both ends) is:  
24 – 29 N•m (2.4 – 3.0 kg-m, **17 – 22 ft-lb**)
- 
- 
-

## EXAMPLE PHOTOS

### Examples (Additional Photos) of Area 1 Perforation Inspection

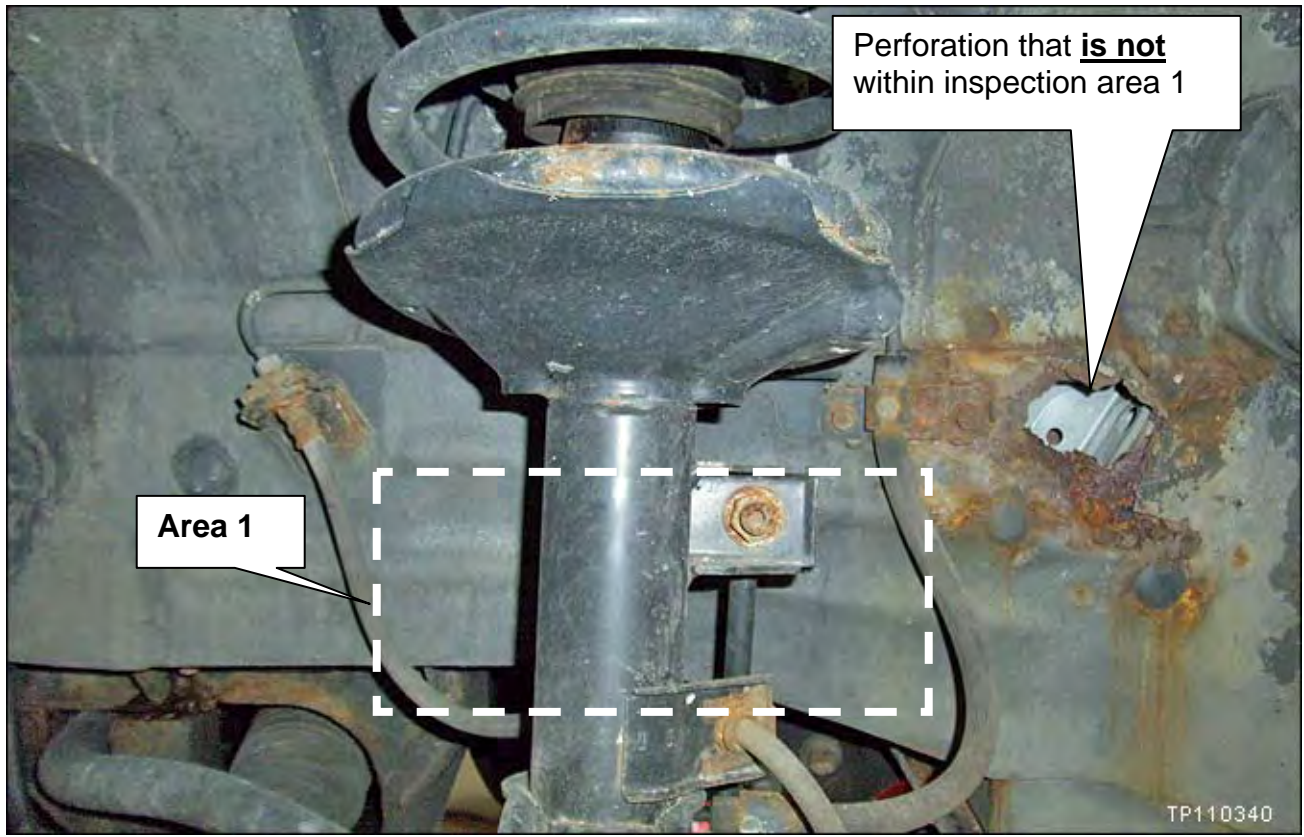

### Example (Additional Photo) of Area 1 Perforation Inspection

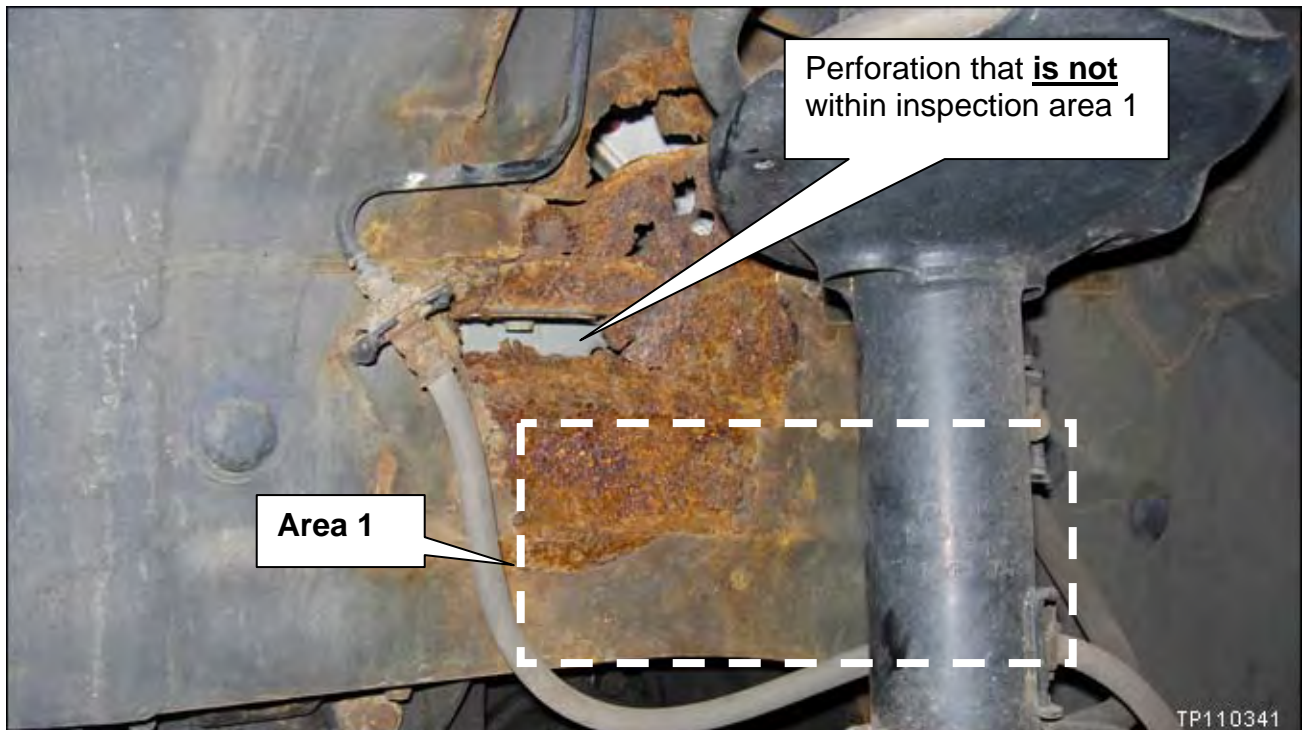

**Example (Additional Photo) of Area 1 Perforation Inspection**

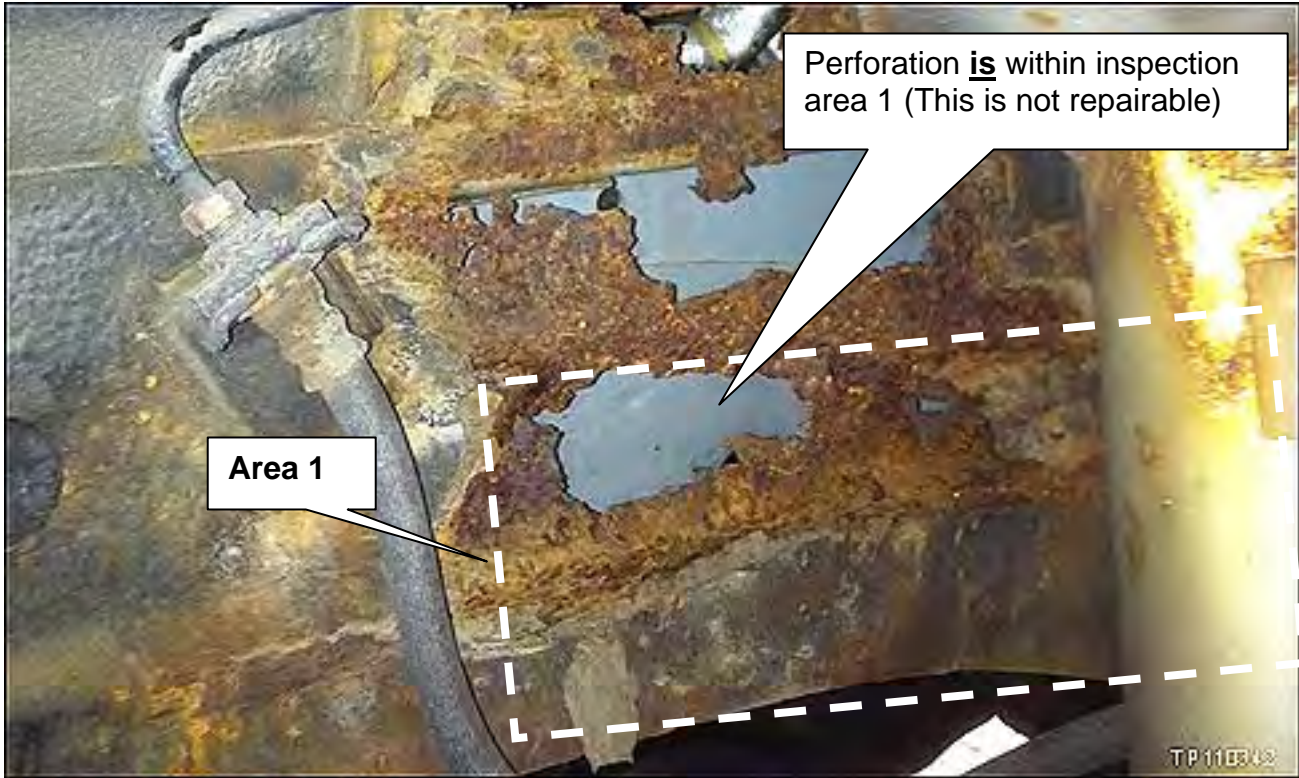

**Example (Additional Photo) of Area 2 Scab Corrosion Inspection**

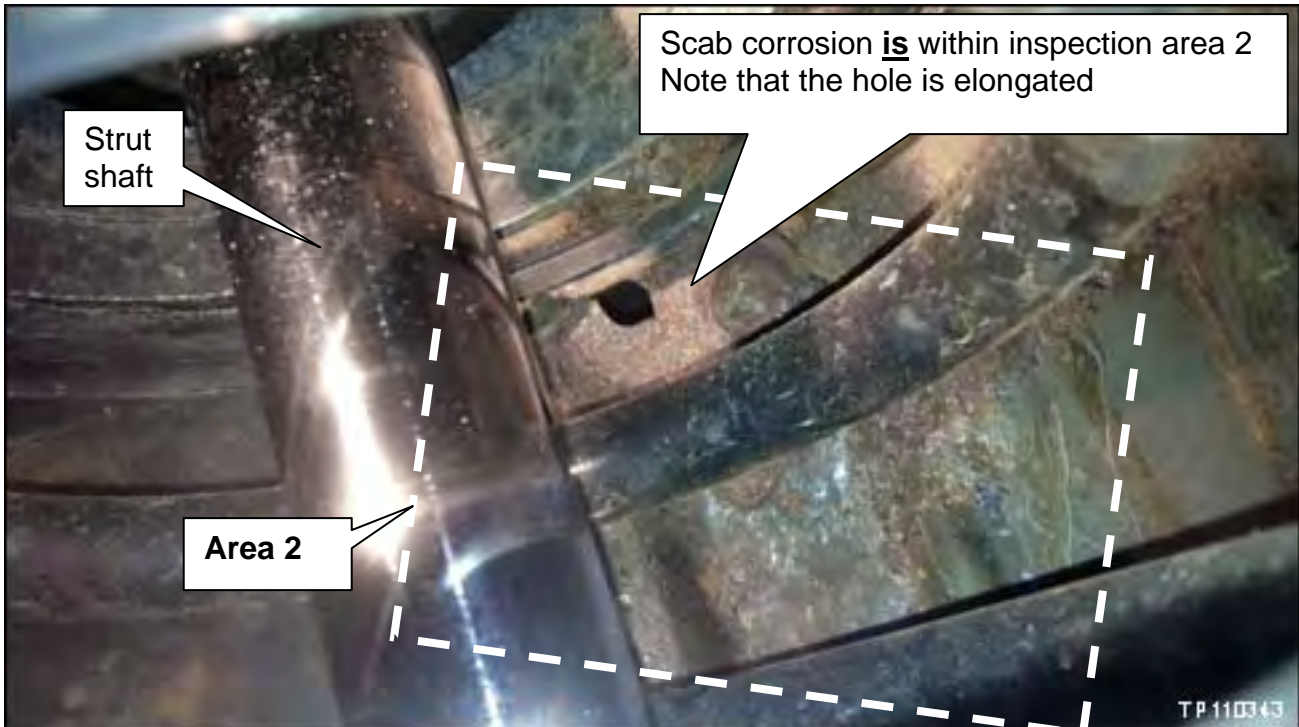



## REQUIRED SPECIAL TOOLS

### Ratchet Strap (J-50836)

- Each dealer will be shipped, at no charge, one Ratchet Strap.
- Additional tools can be ordered from TechMate at 1-800-662-2001.



### Rivet Gun (J-50827)

- Each dealer will be shipped, at no charge, one Rivet Gun.
- First time use; tool is shipped with collapsed rivet nut, remove and discard.
- Additional tools can be ordered from TechMate at 1-800-662-2001.

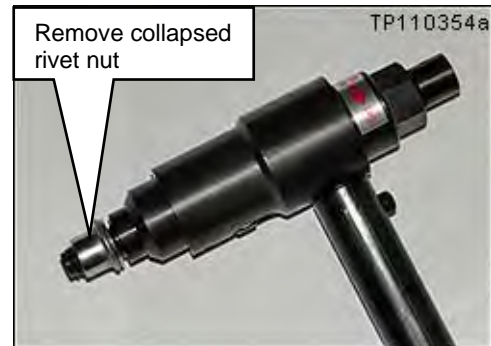

### 2:1 Dispensing Gun (J-50816)

- This tool is used to dispense LORD Fusor® 108B (structural adhesive).
- Each dealer will be shipped, at no charge, one 2:1 Dispensing Gun.
- Additional tools can be ordered from TechMate at 1-800-662-2001.



### 1:1 Dispensing Gun (Caulking Gun)

- This tool is used to dispense LORD Fusor® 800EZ (seam sealer).
- Caulking guns are commonly used for application of other automotive products. Each dealer should already have a caulking gun as a shop tool.



### 33/64 Drill Bit (J-50878)

- Each dealer will be shipped, at no charge, one 33/64 Drill Bit.
- Additional tools can be ordered from TechMate at 1-800-662-2001.

## PARTS INFORMATION

### Nissan Parts (Local PDC)

DESCRIPTION	PART #	QUANTITY
Repair Kit (Hood Ledge LH Kit A - Includes 1 repair bracket, 12 bolts, 8 nuts and 4 rivet nuts)	F4195 – 0W00C	1, if needed
Joint Assy-STR (column upper joint – (steering shaft))	48070 – 0W00A	1, if needed
Butyl Sealer (200 cm roll)	B6553 – 89915	1 roll will service approximately 20 vehicles
Clip (spring lock) (for brake line mounts)	46206 – 2J00A	2, for each strut removed
Nut (for lower strut mount)	54588 – ED00A	2, for each strut removed
Nut (for upper strut mount)	01225 – 00231	3, for each strut removed
Nut (for sway bar link)	08918 – 3421A	As needed if strut is removed

### Other Products

DESCRIPTION	PRODUCT #	SOURCE	QUANTITY
Self Etching Primer (DuPont Etch Primer)	A-4119S™ (or equivalent)	Local DuPont supplier	1 per vehicle (12 oz can)
3M Rubberized Undercoating	051135 – 08883 (or equivalent)	Local 3M™ supplier	1 per vehicle (24 oz can)
3M Bondo Fiberglass Repair Kit	422 (or equivalent)	Local 3M™ supplier	1 kit will service perforations for 8 strut/wheel housings
LORD Fusor® 108B (structural adhesive – includes 2 mixing nozzles)	999MP – 108BP	Nissan Chemicals	1 cartridge will service 2 repair bracket installations
LORD Fusor® 800EZ (seam sealer)	999MP – 9G000P	Nissan Chemicals	1 cartridge for each repair bracket installation
Nissan Rust Penetrant	999MP-A3020P (or equivalent)	Nissan chemical	Shop Supply
Disposable mixing container for fiberglass resin (one time use)	N/A	Local source	1 container per level 2 repair.
Disposable bush for application of fiberglass resin (one time use)	N/A	Local source	1 bush per level 2 repair.
Isopropyl Alcohol		Local source	Shop Supply

**Local DuPont Supplier:** For help finding a local source for the DuPont product listed above or obtaining an MSDS, contact DuPont at 1-800-438-3876.

**Local 3M™ Supplier:** For help finding a local source for the 3M™ products listed above or obtaining an MSDS, contact 3M™ Automotive Aftermarket Division at 1-877-MMM-CARS.

**Nissan Chemicals:** Order this item through the Nissan Maintenance Advantage program: Phone: 877-NIS-NMA1 (877-647-6621), Fax 216.881.7923, Website order via link on dealer portal [www.NNAnet.com](http://www.NNAnet.com) and click on “Tire Advantage” link or order direct at [www.nissantire.com](http://www.nissantire.com). The MSDS for these chemicals will also be found on this site.

## CLAIMS INFORMATION

Submit a Campaign (CM) line claim using the following claims coding:

“CM” I.D.: R1108

CAMPAIGN ID	DESCRIPTION	OP CODE	FRT
R1108	Inspect Only – No Significant Rust – No Repair Needed	R11080	0.2 hrs.

OR

CAMPAIGN ID	DESCRIPTION	OP CODE	FRT	EXPENSE CODE
R1108	Driver Side Repair w/o Fiberglass and Level 1 RH side	R11081	4.3 hrs.	*100,101
<b>Combination</b>	<b>Description</b>	<b>Op code</b>	<b>FRT</b>	
Only if needed	Replace Steering Column Upper Joint (Steering Shaft)	R1108A	0.3 hrs.	
<b>Combination</b>	<b>Description</b>	<b>Op code</b>	<b>FRT</b>	<b>Expense code</b>
Only if needed	Replace Brake Line Front LH Side	R1108B	0.3 hrs.	*006
<b>Combination</b>	<b>Description</b>	<b>Op code</b>	<b>FRT</b>	<b>Expense code</b>
Only if needed	Replace Brake Master Cylinder	R1108C	0.6 hrs.	*006
*Each Expense Code can only be claimed once.				

OR

CAMPAIGN ID	DESCRIPTION	OP CODE	FRT	EXPENSE CODE
R1108	Driver Side Repair with Fiberglass and Level 1 RH side	R11082	4.6 hrs.	*100, 101,102
<b>Combination</b>	<b>Description</b>	<b>Op code</b>	<b>FRT</b>	
Only if needed	Replace Steering Column Upper Joint (Steering Shaft)	R1108A	0.3 hrs.	
<b>Combination</b>	<b>Description</b>	<b>Op code</b>	<b>FRT</b>	<b>Expense code</b>
Only if needed	Replace Brake Line Front LH Side	R1108B	0.3 hrs.	*006
<b>Combination</b>	<b>Description</b>	<b>Op code</b>	<b>FRT</b>	<b>Expense code</b>
Only if needed	Replace Brake Master Cylinder	R1108C	0.6 hrs.	*006
*Each Expense Code can only be claimed once.				

**CLAIMS INFORMATION continued**

<b>CAMPAIGN ID</b>	<b>DESCRIPTION</b>	<b>OP CODE</b>	<b>FRT</b>	<b>EXPENSE CODE</b>
R1108	Driver Side Repair w/o Fiberglass and Level 2 RH with Fiberglass Repair	R11083	4.8 hrs.	*100, 101,102
<b>Combination</b>	<b>Description</b>	<b>Op code</b>	<b>FRT</b>	
Only if needed	Replace Steering Column Upper Joint (Steering Shaft)	R1108A	0.3 hrs.	
<b>Combination</b>	<b>Description</b>	<b>Op code</b>	<b>FRT</b>	
Only if needed	Remove and Install Front RH Strut	R1108D	0.4 hrs.	
<b>Combination</b>	<b>Description</b>	<b>Op code</b>	<b>FRT</b>	<b>Expense code</b>
Only if needed	Replace Brake Line Front LH Side	R1108B	0.3 hrs.	*006
<b>Combination</b>	<b>Description</b>	<b>Op code</b>	<b>FRT</b>	<b>Expense code</b>
Only if needed	Replace Brake Master Cylinder	R1108C	0.6 hrs.	*006
*Each Expense Code can only be claimed once.				

**OR**

<b>CAMPAIGN ID</b>	<b>DESCRIPTION</b>	<b>OP CODE</b>	<b>FRT</b>	<b>EXPENSE CODE</b>
R1108	Driver Side Repair with Fiberglass and Level 2 RH with Fiberglass Repair	R11084	5.1 hrs.	*100, 101,102
<b>Combination</b>	<b>Description</b>	<b>Op code</b>	<b>FRT</b>	
Only if needed	Replace Steering Column Upper Joint (Steering Shaft)	R1108A	0.3 hrs.	
<b>Combination</b>	<b>Description</b>	<b>Op code</b>	<b>FRT</b>	
Only if needed	Remove and install Front RH Strut	R1108D	0.4 hrs.	
<b>Combination</b>	<b>Description</b>	<b>Op code</b>	<b>FRT</b>	<b>Expense code</b>
Only if needed	Replace Brake Line Front LH Side	R1108B	0.3 hrs.	*006
<b>Combination</b>	<b>Description</b>	<b>Op code</b>	<b>FRT</b>	<b>Expense code</b>
Only if needed	Replace Brake Master Cylinder	R1108C	0.6 hrs.	*006
*Each Expense Code can only be claimed once.				

**CLAIMS INFORMATION continued**

**OR**

<b>CAMPAIGN ID</b>	<b>DESCRIPTION</b>	<b>OP CODE</b>	<b>FRT</b>
R1108	Inspect only – vehicle is not repairable	R11085	0.3 hrs.

**OR**

<b>CAMPAIGN ID</b>	<b>DESCRIPTION</b>	<b>OP CODE</b>	<b>FRT</b>	<b>EXPENSE CODE</b>
R1108	Driver Side Repair; 1 or both bolts will not torque (As explained on page 29 and shown in Figure RB25.)	R11086	3.4 hrs.	*103
*Each Expense Code can only be claimed once.				

**EXPENSE CODES**

<b>EXPENSE CODE</b>	<b>DESCRIPTION</b>	<b>MAX AMOUNT</b>
100	Primer and Undercoat	\$47.88
101	Adhesive, Seam Sealer, and Butyl	\$68.37
102	Fiberglass Patch, mixing container, and brush	\$2.70
103	Primer and Adhesive	\$74.18
006	Brake Fluid	\$7.98
502	Rental Car	\$240.00

- Each expense code can be claimed only once per repair order.
- Corresponding op-code must be claimed with each expense code.

## OWNER LETTER

Dear Nissan owner:

This notice is sent to you in accordance with the requirements of the National Traffic and Motor Vehicle Safety Act. Nissan has decided that a defect that relates to motor vehicle safety exists in some 1996-2004 model year Nissan Pathfinder vehicles. Our records indicate that you own or lease the Nissan vehicle identified by the VIN on the cover of this notice.

### Reason for Recall

Nissan recently discovered that, in certain instances, in states where heavy concentrations of road salt are used in the winter, the front driver's side strut tower housing can develop corrosion that may cause strut tower housing damage. In certain cases this may allow the strut tower housing to contact the steering column. This would create noise and a noticeable difference in steering effort. If not addressed, this may lead to steering system damage, and possibly brake line damage, which could increase the risk of a crash.

Below are States that regularly use road salt in winter:

Connecticut	Maine	New Hampshire	Vermont
Delaware	Maryland	New Jersey	West Virginia
District of Columbia	Massachusetts	New York	Wisconsin
Illinois	Michigan	Ohio	
Indiana	Minnesota	Pennsylvania	
Iowa	Missouri	Rhode Island	

According to our records, your Pathfinder is not registered in one of these States and does not have to be repaired.

However, if your Pathfinder was previously registered in one of the above States or it is driven there often during winter months, you may bring your vehicle into the dealer for inspection. Please leave this notice in your Pathfinder for any future owners who may wish to have this repair performed.

### What Nissan Will Do

Because your Pathfinder is not registered in one of the above States, it does not have to be repaired. However, at your request your Nissan dealer will inspect, and if necessary, repair the strut tower housing. In the meantime, if you have concerns about corrosion in the front driver's side strut tower housing in the front wheel well area of your vehicle or you have noticed an unusual noise coming from that area of the vehicle, or a change in the steering effort, we urge you to bring your vehicle into the nearest Nissan dealer for an immediate inspection.

### What You Should Do

If your vehicle is operating normally and there is no noticeable corrosion in the driver's side strut tower housing in the front wheel well area, you do not need to take any immediate action.

If you have concerns about corrosion in the front driver's side strut tower housing in the front wheel well area of your vehicle or you have noticed unusual noise coming from that area of the vehicle, or a change in the steering effort, please contact your Nissan dealer for an immediate inspection.

Please bring this notice with you when you keep your service appointment. Instructions have been sent to your Nissan dealer.

If you have paid to have your strut housing sheet metal repaired due to corrosion prior to this campaign, you may be eligible for reimbursement of the related expense. If you have additional questions you may contact the National Consumer Affairs Department, Nissan North America, Inc., P.O. Box 685003, Franklin, TN 37068-5003. The toll free number is 1-800-NISSAN1 (1-800-647-7261). You may also submit a complaint to the Administrator, National Highway Traffic Safety Administration, 1200 New Jersey Avenue, SE., Washington, DC 20590; or call the toll-free Vehicle Safety Hotline at 1-888-327-4236 (TTY: 1-800-424-9153); or go to <http://www.safercar.gov>.

**Federal law requires that any vehicle lessor receiving this recall notice must forward a copy of this notice to the lessee within ten days.**

Thank you for your cooperation. We are indeed sorry for any inconvenience this may cause you.

## NON REPAIRABLE REPORT

If it is determined that the vehicle is **not repairable based on the presence of perforation or scab corrosion**, complete the form below and Fax it to Morley (see Fax # below).

- Dealer faxes inspection form to Morley.
- Morley contacts the customer within 24 hours to explain the next steps.
- Morley schedules and performs an inspection to confirm the dealer's findings.
- Morley will negotiate with the customer.
- Morley will schedule a surrender date and provide the dealer with instructions and a package of documents.
- After surrender Morley will arrange the vehicle pickup and scrap.

		<b>NISSAN NORTH AMERICA, INC.</b>			
<b>Pathfinder Strut Corrosion Campaign - Vehicle Not Repairable</b>					
<b>CUSTOMER / VEHICLE INFORMATION</b>					
<b>LAST NAME:</b>		<b>FIRST NAME:</b>			
<b>ADDRESS:</b>					<b>APT #:</b>
<b>CITY:</b>		<b>DEALER NAME:</b>			
<b>STATE:</b>		<b>DEALER CODE:</b>		<b>REGION:</b>	
<b>ZIP CODE:</b>		<b>CONTACT:</b>			
<b>DAY TIME#:</b>		<b>TELEPHONE:</b>			
<b>CELL #:</b>		<b>VIN:</b>			
<b>ALT#:</b>		<b>MAKE/MODEL:</b>	Nissan Pathfinder	<b>MILEAGE:</b>	
<b>EMAIL:</b>		<b>MODEL YEAR:</b>		<b>SEC+ #:</b>	
<b>NNA Internal Use:</b>					
<b>ORIGINATOR CODE = DI</b>	<b>TREAD =VEHICLE CONCERNS / SUSPENSION FRONT STRUT(S) / FINANCIAL ASSISTANCE REQUEST (CAMPAIGN/RECALL)</b>				
<b>PLEASE REMEMBER TO DOCUMENT ALL FIELDS</b>					
<b>COMMENTS:</b>					

<b>Morley</b>	
Fax #	Helpdesk #
877-276-2445	877-477-2292