

# Technical Service Bulletin



## 19J1 UPDATE – 4.0 I Quality Package (NVLW)

July 23, 2013

Model(s)	Year	VIN Range	Vehicle-Specific Equipment
S6, S7, A8, and S8	2013	See Campaign/Action screen in ElsaWeb	None

## Condition

A quality package has been defined for Audi vehicles with 4.0L TFSI engine manufactured within a specific period. This Update is in effect until removed.

Vehicle must meet all of the following criteria:

- Procedure is valid only for vehicles that show the **19J1** code in the ElsaWeb Campaign/Action Information screen on the day of repair.
- Vehicle must be within the New Vehicle Limited Warranty.
- Procedure must be performed within the allotted time frame stated in this Technical Service Bulletin.
- Procedure must be performed on applicable vehicles in dealer inventory prior to sale.

## Technical Background

A quality package has been defined for Audi vehicles with 4.0L TFSI engine manufactured within a specific period.

# Technical Service Bulletin



## Service

### Criteria 01 and 02: SVM Software Update

#### SVM Update Instructions

1. Follow all instructions in TSB 2011732: 00 Software Version Management (SVM), operating instructions.
2. Update the engine control module (ECM), J623 (address word 01) and the transmission control module (TCM), J217 (address word 02) using the SVM action code listed in the table below.

Model	Engine and/or Transmission	Old Software Part Number	Old Software Version	New Software Part Number	New Software Version	SVM Action Code
S6 / S7	4.0T CEUC	4G0906014B	0005	4G0906014B	0006	19J1A001
S6 / S7	S tronic	4G1927156S	0008	4G1927156S	0009	
A8	4.0T CEUA	4H0906014B	0002	4H0906014B	0003	
A8	8 speed transmission	4H1927158BK	1004	4H1927158BK	1005	
A8	8 speed transmission and Sport Diff.	4H1927158CA	1004	4H1927158CA	1005	
S8	4.0T CGTA	4H0907557B	0003	4H0907557B	0004	
S8	8 speed transmission	4H1927158BL	1004	4H1927158BL	1005	

## Criteria 03 and 04: Replacing Coolant Thermostat and Quick Release Coupling

1. Replace the coolant thermostat and the quick release coupling by following the instructions in *ElsaWeb >> Repair Manual >> Engine >> Engine Mechanical >> 19 Cooling System >> Removal and Installation >> Map Controlled Engine Cooling Thermostat -F265-* (Figure 1 and Figure 2).

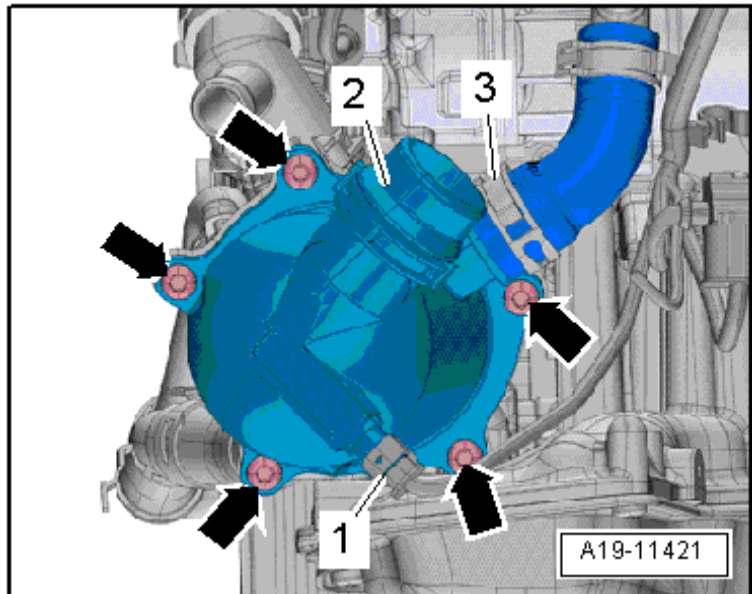


Figure 1. Coolant thermostat (2).



**Tip:** The quick release coupling is located directly on the coolant thermostat. It is removed together with the coolant thermostat when the coolant thermostat is replaced. However, the coolant thermostat does not have to be removed when the quick release coupling is replaced (Figure 1 and Figure 2).

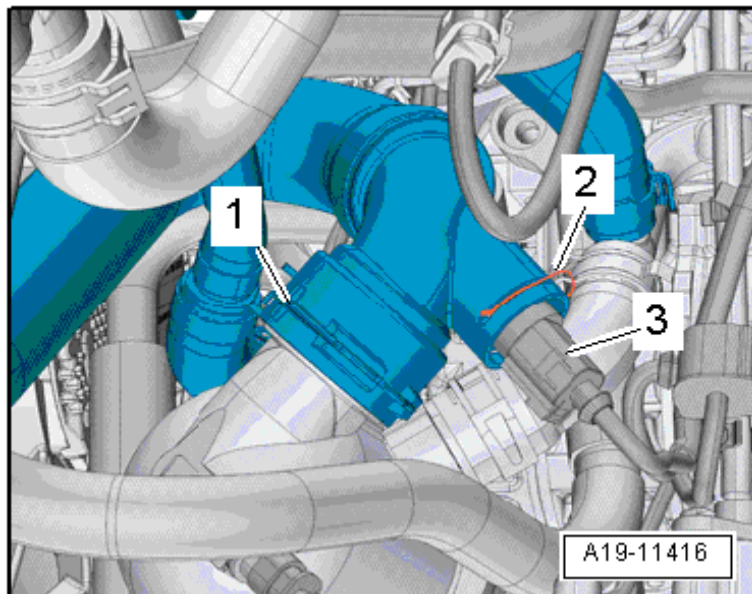
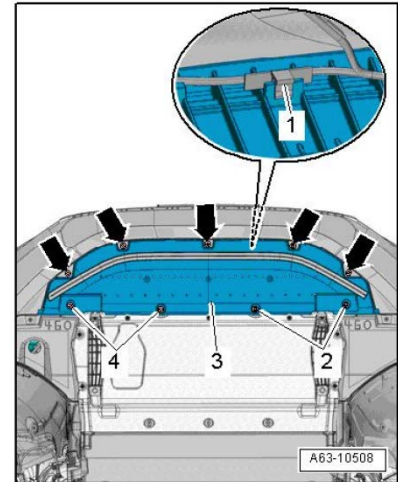


Figure 2. Quick release coupling (1).

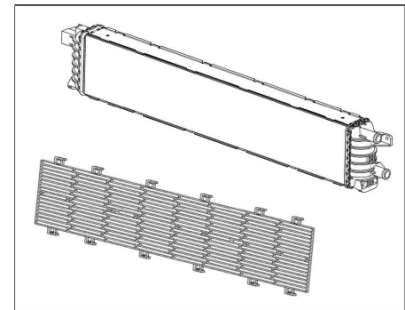
## Criteria 05: Install Protective Grille

1. Remove closure plate for bumper cover (Figure 3)

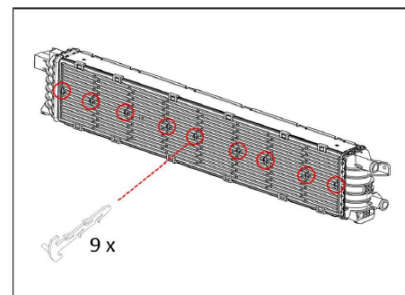


**Figure 3.** Closure plate for bumper cover (3).

2. Fit protective grille onto radiator (Figure 4) and secure with nine retaining clips (Figure 5).



**Figure 4.** Fit protective grille onto radiator.



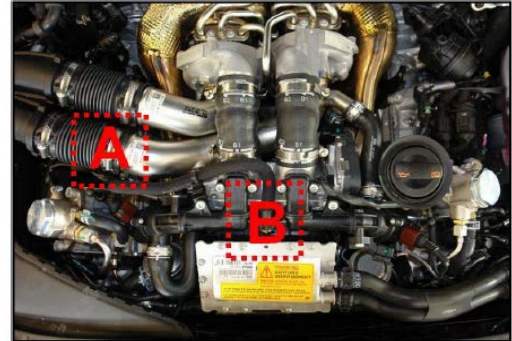
**Figure 5.** Secure grille with nine retaining clips.

# Technical Service Bulletin

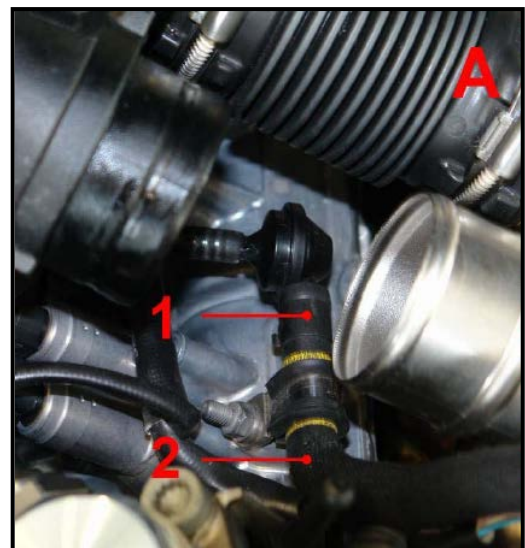


## Criteria 06: Replace ACF Hose

1. Replace ACF hose (Figure 6 and Figure 7). The hose clip can be re-used.

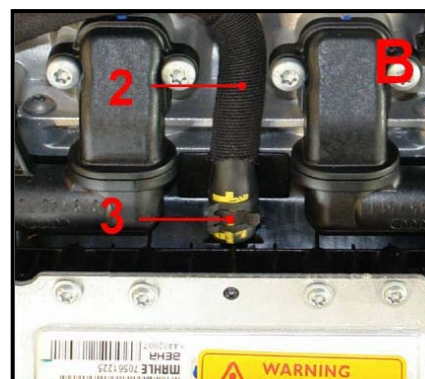


*Figure 6. Location of ACF hose (A).*



*Figure 7. ACF hose (2) and hose clip (1).*

2. Replace hose clip (Figure 8).



*Figure 8. Hose clip (3).*

## Criteria 07: Replace Oil Filler Neck

Replace oil filler neck (Figure 9).



**Figure 9.** Oil filler neck.

Torque bolt to 9 Nm (Figure 10).



**Figure 10.** Torque bolt to 9 Nm.



# Technical Service Bulletin



## Warranty

<b>Update Time Requirements/ Reimbursement</b>	To ensure prompt and proper payment, be sure to immediately enter the applicable reimbursement code listed below upon completion of the repair work. Claims will be paid only for vehicles that show the <b>19J1</b> code in the ElsaWeb Campaign/Action Information screen on the day of repair.
--	---

### 19J1 Saga Claim Entry Procedure

Check ElsaWeb to determine whether Update **19J1** is open.

**Service No.:** 19J1

**Damage Code:** 0099

**Parts Manufacturer -** Removed part: 002

#### Claim Type

Sold vehicle = 7 10

Unsold vehicle = 7 90

**Vehicles may have more than one criteria. Complete and claim all applicable criteria on one claim.**

### Saga Accounting Instructions

Criteria ID	Repair operation	Labor Operation Number	TU
01	Connect battery charger and vehicle diagnostic tester, update engine control unit	2470 2599	40
and/or			
02	Additionally update gearbox control unit	3730 2599	10
and/or			
03 (without 04)	Replace coolant thermostat	1958 5599	210
and/or			
03 and 04	Replace coolant thermostat and quick-release coupling	1958 5599	210
and/or			
04 (without 03)	Replace quick-release coupling	1962 5599	180
and/or			
05	Install protective grille	1980 3399	30

# Technical Service Bulletin



and/or			
06	Replace ACF hose	2022 5599	20
and/or			
07	Replace oil filler neck	1582 4199	10
Criteria ID	Part Number	Part Description	Quantity
03	079121115AQ	Coolant thermostat	1
04	4G0122293BF	Quick-release coupling	1
03, 04 (claim only once)	G 013A8J1G	Coolant additive	1.5
05	8K0820746C	Protective grille	1
	8K0867646	Clip	9
06	079133394CF	ACF Hose	1
	N 90770201	Hose clip	1
	N 0209022	Cable tie	1
07	079103499AE	Oil filler neck	1
<p>There is no reimbursement for vehicle wash or loaner vehicle.</p> <p><b>If the vehicle is outside of the specified warranty period, the customer has the option to pay for the repair.</b></p> <p><i>If the customer agrees to pay for the repair:</i></p> <p>Fax the information to (248) 754-5093 and provide VIN, applicable Service Number, Customer Info, Dealer Number and Date.</p>			



# Technical Service Bulletin

---



- Additional Actions** Some of the affected vehicles may be involved in additional Actions. Please check your ElsaWeb Campaign/Action Information screen so that any *additional required work can be done simultaneously*.
- Update Verification** For verification, *always* check the ElsaWeb Campaign/Action Information screen. The ElsaWeb system is the *only* binding inquiry and verification system; other systems are not valid and *may result in non-payment* of a claim.
- Help for Claim Input** For questions regarding claim input, contact the Warranty Helpline.
- Required Customer Notification** Inform your customer in writing by recording on the Repair Order any and all work that was conducted on the vehicle, including any and all updates completed under this Update.

# Technical Service Bulletin



## Required Parts and Tools

Criteria ID	Part Number	Part Description	Quantity
03	079121115AQ	Coolant thermostat	1
04	4G0122293BF	Quick-release coupling	1
03, 04 (claim only once)	G 013A8J1G	Coolant additive	1.5
05	8K0820746C	Protective grille	1
	8K0867646	Clip	9
06	079133394CF	ACF Hose	1
	N 90770201	Hose clip	1
	N 0209022	Cable tie	1
07	079103499AE	Oil filler neck	1

- Properly destroy and dispose of removed parts in accordance with all state and local requirements, unless otherwise indicated and/or requested through SAGA.
- If you have exhausted your allocated parts and you require additional parts for vehicles affected by this Update but have exceeded your Upper Order Limit, please submit your requests for additional parts via email to [upperorderlimits@audi.com](mailto:upperorderlimits@audi.com). Be sure to include the affected VINs with your order. Prior to submitting your request, ensure that each vehicle has the **19J1** code open in ElsaWeb. Your order will be reviewed and processed accordingly.

## Additional Information

All parts and service references provided in this Update are subject to change and/or removal. Always check with your Parts Department and service manuals for the latest information.