

GR8 Battery Tester Information

TO: SDC EST CEN WST
FROM: Subaru of America, Inc.
DEPARTMENT: Service
DATE: 12/13/2013
CATEGORY: Parts/Service

Good news, everyone! The majority of dealers have successfully set up their Midtronics GR8 battery testers and have them connected to the cloud. We hope that all users have been able to make use of the new features of these devices. For those dealers still requiring additional technical support, please [click here](#) to download the instruction manual. If further support is required, please contact Midtronics at 800 776 1995, option 1.

Until further notice, we will continue to accept GR1 battery test codes for warranty claim submission.

Questions? Contact Garrick Goh at ggoh@subaru.com.



SUBARU®

GR8-1100 EST

***Battery Diagnostic Station
with Alternator/Starter Test Module***



INSTRUCTION MANUAL

This page intentionally blank.

Contents

Safety Guidelines	5	Chapter 4: System Test	21
General Safety Precautions	5	System Test Results	22
Personal Precautions	5	Battery Test Results	22
Preparing To Charge The Battery	6	Starter Test Results	23
Grounding And AC Power Cord Connection	6	Alternator Test Results	23
Charger Location	7		
DC Connection Precautions	7	Chapter 5: Info	25
Installing The Battery	7	Totals	25
Connecting To The Battery	8	Version	25
Chapter 1: Introduction & Overview	9	Chapter 6: Print/View	26
Front View	9	View Test	26
Back View	9	Send Data	26
Display and Keypad	10		
Data Entry Methods	11	Chapter 7: Utility	27
Menu Icons	11	Clock	27
Option Buttons	11	Time Zone	27
Scrolling Lists	11	DST Mode	27
Alphanumeric Entry	11	Mode	27
Value Boxes	11	Time	27
Menu Structure	12	Format	27
Main Menu	12	Date	27
Charging Menu	12	Users	27
Info Menu	12	Entering a New User ID	27
Print/View Menu	12	Deleting a User ID	28
Utility Menu	12	On/Off	28
Conventions Used In This Manual	13	Shop	28
Initial Start-up	13	Display	28
Preparing to Charge	14	Coupon	29
Inspecting the Battery	14	Edit Coupon	29
Connecting the Clamps	14	Temp	29
Connecting to AC Power	14	Language	29
Setting User Preferences	14	Format	29
Chapter 2: Charging	15	Update	29
Diagnostic	15	Printer (Optional)	30
Diagnostic Charging	16	Buzzer	30
Aborting a Charge Session	16	Dealer Number	30
Completing a Charge Session	17	WiFi Disable	30
Top-Off Mode	17	WiFi Setup	30
Diagnostic Charging Results	17	Scan	30
State-of-Health (SOH)	18	WiFiConfig File	31
Jump Start	18	Manual	31
Manual Charging	18	IP Setup	31
Chapter 3: Power Supply Mode	20	CVG	31

Chapter 8: Maintenance & Troubleshooting	32
Help	32
Terms/Definitions	32
Troubleshooting	32
Service Info	32
Test Cable Maintenance	32
Attaching the Charger Cables	33
Test Messages	33
Error Messages	34
Appendix	35
Shop Header And Coupon Templates	35

Safety Guidelines

1. General Safety Precautions

1. **IT IS OF UTMOST IMPORTANCE THAT YOU READ THIS MANUAL AND FOLLOW THE SAFETY AND OPERATING INSTRUCTIONS EXACTLY BEFORE USING YOUR CHARGER.** SAVE THESE INSTRUCTIONS.

 WARNING
Risk of explosive gases Batteries generate explosive gases during normal operation, and when discharged or charged.

- 1.1 To reduce risk of battery explosion, follow these safety instructions and those published by the battery manufacturer and the manufacturer of any equipment you intend to use in the vicinity of a battery. Review cautionary marking on these products and on the engine, and on the vehicle or equipment containing the battery.

 WARNING
Charging a non-rechargeable battery may cause the battery to burst. To reduce the risk of injury, only charge rechargeable lead-acid type batteries including maintenance-free, low-maintenance, or deep-cycle batteries.

If you are uncertain as to the type of battery you are attempting to charge, or the correct procedure for checking the battery's state of charge, contact the seller or battery manufacturer.

- 1.2 Use of an attachment not recommended or sold by the battery charger manufacturer may result in a risk of fire, electric shock, or injury to persons.
- 1.3 To reduce risk of damage to the electric plug and cord, pull by the plug rather than by the cord when disconnecting the charger.
- 1.4 Position the AC and DC leads to avoid tripping over them and to prevent damage by hood, doors, or moving engine parts; protect from heat, oil, and sharp edges.
- 1.5 Do not operate the charger if it has received a sharp blow, been dropped or otherwise damaged in any way; take it to a qualified service center.
- 1.6 Do not disassemble charger; take it to a qualified service center when repair is required. Incorrect reassembly may result in a risk of electric shock or fire.
- 1.7 To reduce risk of electric shock, unplug the charger from the AC outlet before attempting any maintenance or cleaning. Turning off the controls will not reduce this risk.
- 1.8 Connect and disconnect the battery leads only when the AC supply cord is disconnected.
- 1.9 Do not overcharge the battery. (See sections 3 and 10 in the safety instructions)
- 1.10 Charge the battery in a dry, well-ventilated area.

- 1.11 Never place articles on or around the charger, or locate the charger in a way that will restrict the flow of cooling air through the cabinet.
- 1.12 An extension cord should not be used unless absolutely necessary. (See paragraph 4.3.)
- 1.13 Have a damaged cord or plug replaced immediately.
- 1.14 Do not expose the charger to rain or snow.

2. Personal Precautions

 WARNING
Non-rechargeable batteries may burst when charging causing personal injury and damage. To avoid electrical shock or burn, never alter the charger's original AC cord and plug. Disconnect plug from outlet when charger is idle.

 WARNING	
	Wash hands after handling. Battery posts, terminals, and related accessories contain lead and lead compounds, chemicals known to the state of California to cause cancer and birth defects or other reproductive harm..

- 2.1 Always have someone within range of your voice, or close enough to come to your aid, when working around flooded batteries.
- 2.2 Have plenty of fresh water and soap nearby in case battery acid contacts skin, clothing or eyes.
- 2.3 Wear complete eye protection, clothing protection, and wear rubber soled shoes. Place damp cloth over battery to protect against acid spray. When ground is very wet or covered with snow, wear rubber boots. Avoid touching eyes while working near battery.
- 2.4 If battery acid contacts skin or clothing, wash immediately with soap and water. If acid enters the eye, immediately flush with cold running water for at least 10 minutes, and seek medical attention.
- 2.5 NEVER smoke or allow a spark or flame in vicinity of a battery or engine.
- 2.6 Be extra cautious to reduce risk of dropping a metal tool onto the battery. It might spark or short circuit the battery or other electrical part that may cause an explosion.
- 2.7 Before working with a flooded battery, remove personal metal items such as rings, bracelets, necklaces, watches, etc. A flooded battery can produce a short circuit current high enough to weld such items causing a severe burn.

2.8 The charger is not intended to supply power to a low-voltage electrical system other than applications using rechargeable, flooded type batteries. Do not use the battery charger for charging dry-cell batteries commonly used with home appliances. These batteries may burst and cause personal injury and property damage.

2.9 **NEVER** charge a frozen battery; thaw it out first.

3. Preparing To Charge The Battery

3.1 If it is necessary to remove the battery from vehicle to charge it, always remove the grounded terminal from the battery first. Make sure all accessories in the vehicle are off, so as not to cause an arc.

3.2 Be sure the area around the battery is well ventilated while the battery is being charged. Gas can be forcefully blown away by using a piece of cardboard or other non-metallic material as a fan.

3.3 Clean the battery terminals. Be careful to keep corrosion from coming into contact with your eyes.

3.4 Add distilled water in each cell until the battery acid reaches the level specified by the manufacturer. This helps purge excessive gas from the cells. Do not overfill. For a battery without caps, carefully follow the manufacturer's recharging instructions

3.5 Study all battery manufacturer's specific precautions such as removing or not removing cell caps while charging and recommended rates of charge.

3.6 Determine the voltage of the battery by referring to the car owner's manual and make sure that the output voltage selector switch is set at the correct voltage. If the charger has an adjustable charge rate, charge the battery initially at lowest rate. If the charger has only one voltage, verify that the battery voltage matches the voltage of charger.

For a charger not having an output voltage selector switch, determine the voltage of the battery by referring to car owner's manual and make sure it matches the output rating of the battery charger.

4. Grounding And AC Power Cord Connection



NOTE: When you start a new test, the last test results in memory are overwritten. Remember to record or print the results if you need to retain them.

4.1 The charger must be grounded to reduce risk of electric shock. The charger is equipped with an electric cord having an equipment grounding conductor and a grounding plug. The plug must be plugged into an outlet that is properly installed and grounded in accordance with all local codes and ordinances.

⚠ DANGER

Hazardous voltage.
An improper connection can result in electric shock

To avoid electrical shock or burn, never alter the charger's original AC cord and plug. Disconnect plug from outlet when charger is idle.

IF THE PLUG DOES NOT FIT THE OUTLET, HAVE A PROPER OUTLET INSTALLED BY A QUALIFIED ELECTRICIAN.

4.2 This battery charger is for use on a nominal 120-volt circuit and has a grounding plug that looks like the plug illustrated in *Figure A*. A temporary adapter, which looks like the adapter illustrated in *Figures B* and *C*, may be used to connect this plug to a two-pole receptacle as shown in *Figure B*, if a properly grounded outlet is not available. The temporary adapter should be used only until a properly grounded outlet can be installed by a qualified electrician.

⚠ DANGER

Hazardous voltage.
An improper connection can result in electric shock

Before using an adapter be certain the center screw of the outlet plate is grounded. The rigid ear or lug extending from the adapter must be connected to a properly grounded outlet. Make certain it is grounded. If necessary, replace the original screw that secures the adapter ear or lug to the cover plate and make the ground connection to the grounded outlet.

USE OF AN ADAPTER IS NOT ALLOWED IN CANADA. IF A GROUNDING-TYPE RECEPTACLE IS NOT AVAILABLE, DO NOT USE THIS APPLIANCE UNTIL THE PROPER OUTLET IS INSTALLED BY A QUALIFIED ELECTRICIAN.

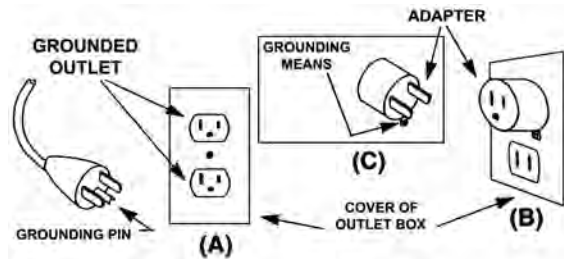

4.3 An extension cord should not be used unless absolutely necessary. Use of an improper extension cord could result in a risk of fire and electric shock. If an extension cord must be used, make sure:

- a. that the pins on plugs of the extension cord are the same number, size, and shape as those of the plug on the charger;
- b. that the extension cord is properly wired and in good electrical condition;
- c. that the wire size is large enough for the AC ampere rating of charger as specified in the following table.

Recommended minimum AWG* size for extension cords for battery chargers					
AC input rating amperes		AWG* size of cord			
Equal or greater than:	But less than:	Length of cord, feet (m)			
		25 (7.6)	50 (15.2)	100 (30.5)	150 (45.6)
8	10	18	14	12	10
10	12	16	14	10	8
12	14	16	12	10	8
14	16	16	12	10	8
16	18	14	12	8	8

*American Wire Gauge

5. Charger Location

- 5.1 Locate the charger as far away from the battery as the charger cables permit.
- 5.2 Never place the charger directly above the battery being charged; gases from the battery will corrode and damage the charger.
- 5.3 Never allow battery acid to drip on the charger when taking gravity readings or filling a battery.
- 5.4 Operate the charger only in a well-ventilated area that is free of dangerous vapors.
- 5.5 Store the charger in safe, dry location and maintain it in perfect condition.
- 5.6 Do not set the battery on top of the charger or where its acid might drip onto the charger.

6. DC Connection Precautions

- 6.1 All switches should be set in the OFF position and AC cord should be DISCONNECTED from electrical outlet before you connect and disconnect the charger clamps. Never allow the clamps to touch each other.
- 6.2 When attaching the charger clamps, be certain to make the best possible mechanical as well as electrical connection. This will tend to prevent the clamps from slipping off the connections, avoid dangerous sparking, and assure safer and more efficient charging. The clamps should be kept clean.

DANGER

Hazardous voltage.
Can cause death or serious personal injury.

Setting the switches to "OFF" does not always disconnect the charger electrical circuit from the AC power cord or the DC charger clamps.

7. Installing The Battery

CAUTION

Risk of explosive gases.
 A spark near the battery may cause a battery explosion. Follow these steps when the battery is installed in the vehicle to reduce the risk of explosion.

- 7.1 Before working on the vehicle, firmly apply the emergency brake and place the gearshift to NEUTRAL—shift an automatic transmission to PARK.
- 7.2 Locate the charger as far away from the battery as the charger cords permit and position the AC and DC cords to avoid stepping on or tripping over them and to prevent damage by hood, doors, or moving engine parts.
- 7.3 Stay clear of fan blades, belts, pulleys, and any other parts that can cause physical injury.
- 7.4 Turn **OFF** all vehicle loads, including door lights, and correct any defects in the vehicle's electrical system that may have caused low battery.
- 7.5 Check the polarity of the battery posts. The **POSITIVE (POS., P, +)** post usually has a larger diameter than the **NEGATIVE (NEG., N,-)** post.
- 7.6 Determine which post of the battery is grounded (connected) to the chassis. If the negative post is grounded (as in most vehicles), see paragraph 7.7. If the positive post is grounded, see paragraph 7.8.
- 7.7 For a negative-grounded vehicle, first connect the **POSITIVE (RED)** clamp from the charger to the **POSITIVE (POS., P, +)** ungrounded post of the battery. Then connect the **NEGATIVE (BLACK)** clamp to the **NEGATIVE (NEG., N, -)** post of the battery. Do not connect the clamp to the carburetor, fuel lines, or sheet-metal body parts. When disconnecting the charger, always do so in reverse sequence of the connecting procedure; break the first connection while staying as far away from the battery as practical.

- 7.8 For positive-grounded vehicle, connect the **NEGATIVE (BLACK)** clamp from the charger to the **NEGATIVE (NEG., N, -)** ungrounded post of battery. Then connect the **POSITIVE (RED)** clamp to the **POSITIVE (POS., P, +)** post of the battery. Do not connect clamp to carburetor, fuel lines, or sheet-metal body parts. When disconnecting the charger, always do so in reverse sequence of the connecting procedure; break the first connection while staying as far away from the battery as practical.

CAUTION: WHEN POSITIVE (+) POST OF VEHICLE BATTERY IS GROUNDED, DOUBLE CHECK POLARITY.

8. Connecting To The Battery

8. If it is necessary to remove the battery from the vehicle or equipment, always remove the grounded terminal from the battery first.
- 8.1 Check the polarity of battery posts. **POSITIVE (POS., P, +)** post usually has larger diameter than **NEGATIVE (NEG., N, -)** post.
- 8.2 Connect the **POSITIVE (RED)** charger clamp to the **POSITIVE (POS., P, +)** post of battery.
- 8.3 Position yourself as far away from the battery as possible—do not face the battery when making the final connection—then connect the **NEGATIVE (BLACK)** charger clamp to the **NEGATIVE (NEG., N,-)** post.
- 8.4 When disconnecting the charger, always do so in the reverse sequence of the connecting procedure; break the first connection while staying as far away from the battery as practical.
- 8.5 **MARINE "BOAT" BATTERIES MUST BE REMOVED AND CHARGED ON SHORE. TO SAFELY CHARGE THEM ON BOARD REQUIRES EQUIPMENT SPECIFICALLY DESIGNED FOR MARINE USE.**

⚠ DANGER	
	<p>Risk of explosive gases. Can cause death or serious personal injury.</p> <p>Always work in a well-ventilated area. Never smoke or allow a spark or flame in the vicinity of a battery. Batteries can produce a highly explosive mix of hydrogen gas and oxygen, even when the battery is not in operation.</p>

⚠ WARNING	
<p>Risk of explosive gases.</p> <p>Make sure all vehicle loads are OFF to prevent a possible arc..</p>	

Chapter 1: Introduction & Overview

Front View



Back View



- ① **Control Module**
Backlit graphical display and keypad for data entry.
- ② **STATUS light**
Lights in conjunction with beeping alarm to indicate transitions and warnings.
- ③ **Data Card slot**
For data storage and future software updates.
- ④ **ON/OFF Switch**
Turns GR8 power on and off.

- ① **Control Module Serial Number label**
- ② **Cable wrap**
- ③ **Amp Clamp cable**
- ④ **Load Module**
- ⑤ **Wi-fi Antenna**
- ⑥ **Charger Cable connectors**
- ⑦ **AC Power Cord**
- ⑧ **Amp Clamp connection**
- ⑨ **Charge Engine Serial Number label**

Display and Keypad

The charger display and keypad work together to help you quickly find and use the right tools at the right time. The display also keeps you on track with onscreen navigation aids, directions and messages. The illustration shows how the elements on the screen relate to the keypad.

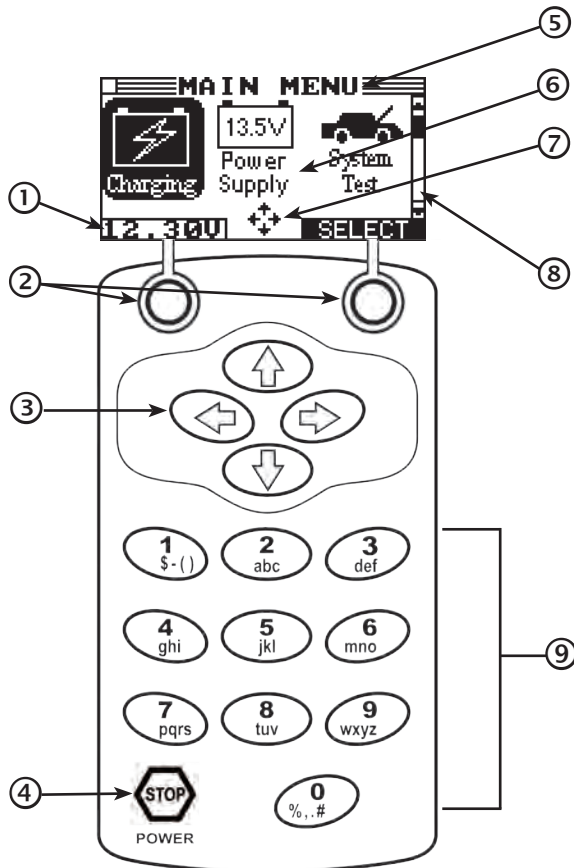

① Voltmeter

When you first connect the charger to a battery it functions as a voltmeter. The voltage reading appears above the left soft key until you move to other menus or functions.

② Soft Keys

Press the two soft keys linked to the bottom of the screen to perform the functions displayed above them. The functions change depending on the menu or test process. So it may be helpful to think of the words appearing above them as part of the keys.

③ Arrow (▲▼◀▶) keys

Press the **ARROW** keys to scroll to numerical values and move to menus and icons

④ Stop Key

Press the **STOP** to stop (abort) a charging session.

⑤ Title Bar

The title bar shows you the name of the current menu, test tool, utility, or function.

⑥ Selection Area

The selection area below the **Title Bar** contains selectable items or dialog boxes that display information or require a response.

⑦ Menu Screen Arrows

When displayed in menu screens, the menu screen arrows show you which **Arrow** key on the keypad to press to display other icons or screens. The Up and Down Menu Screen Arrows, for example, indicate when to press the ▲ or ▼ keys to display the screens above and below the current screen.

The directional Menu Screen Arrows tell you when to use the ◀ or ▶ keys to select an icon.

When displayed under a list of options, the menu screen arrows show you which keypad arrow to press to highlight a character or item in a list.

⑧ Scroll Bar

Another navigational aid is the scroll bar on the right side of the screen. The position of its scroll box shows you whether the screen is the top (or only screen), middle, or last in a series.

Some screens also indicate the page order with a notation such as P1/3 (page 1 of 3).

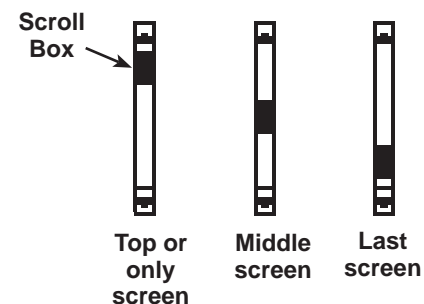

⑨ Alphanumeric Keypad

In some cases, you can use the alphanumeric keypad to enter numerical test parameters instead of scrolling to them with the **ARROW** keys.

You can also use the alphanumeric keys to create and edit customer coupons and your shop contact information on printed test results, and manage User IDs.

To add a space, press ▶. To erase a space and insert a character, press ◀.

Refer to the table below for the characters associated with each alphanumeric key.

Alphanumeric Keys and Associated Characters

Key	Character
①	\$ - () ! " & ' : ; ? 1
②	a b c 2
③	d e f 3
④	g h i 4
⑤	j k l 5
⑥	m n o 6
⑦	p q r s 7
⑧	t u v 8
⑨	w x y z 9
⑩	% , . # < = > / * + @ 0

Data Entry Methods

To perform a particular test or function, the charger requires different types of information. This means that the methods you use to enter information will change depending on the type of information requested.

Typically, the soft key below the right half of the screen confirms your choice, although the command above it may vary. (Examples: **SELECT**, **NEXT**, and **SAVE**.) In a similar fashion, the soft key below the left half of the screen cancels your choice or returns you to the previous screen, although the word above it may also vary. (Examples: **BACK** and **CLEAR**.)

Menu Icons

A menu icon is a graphical representation of a function you can select, such as the DC Amp Meter Test Icon in the DMM Menu. To select an icon, use ◀ or ▶ to highlight it. Highlighting changes the icon to a white picture on a black background. To confirm your selection, press the appropriate soft key.

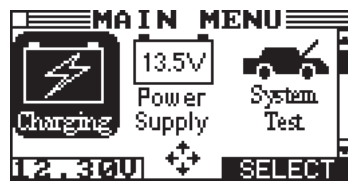

Option Buttons

Some lists have option buttons before each item. To select an item, use ▲ or ▼ to move the dot to the button next to the item. To confirm your selection, press the appropriate soft key.

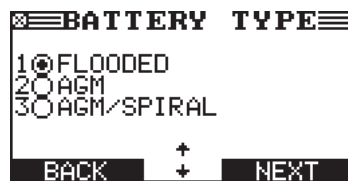

You can also use the alphanumeric keypad to enter the number preceding the option button of your choice. No additional keypress is needed to proceed.

Scrolling Lists

Scrolling lists contain items that extend above and below the screen. The first number above the right soft key indicates the position in the list of the highlighted item.

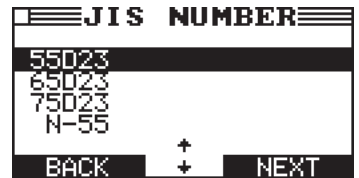

The second number above the right soft key indicates the number of items in the list.

To select an item, use ▲ or ▼ to highlight the item, and press the appropriate soft key.

To move the highlight bar up five lines at a time, press ◀. To move the highlight bar down five lines at a time, press ▶.

Alphanumeric Entry

Some selections require you to use the alphanumeric keypad. These “user-defined” selections have a blinking horizontal line (cursor) to the right of the last character.



Use the keypad to enter the alphanumeric characters. To enter letters, repeatedly tap the alphanumeric key to cycle through its associated characters.

Value Boxes

Value boxes contain items that extend above and below the selection box that contain them. To indicate that there are more values, the symbols ⬆ appear to the right of the box.









To select, use ▲ or ▼ to scroll to the value, or use the keypad to enter the value directly, and press the appropriate soft key. In the illustration the left directional arrow indicates that you can press ◀ to clear all or part of the entry.

Menu Structure

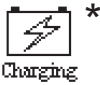
This section contains a graphical representation of the menu structure with brief descriptions of the utilities in each menu.



Main Menu

The Main Menu is the starting point for all tools and utilities, which are depicted as icons. Some icons lead directly to the function they represent, while others are menu icons that lead to two or more options. Menu icons marked with an asterisk (*) are mapped on the following pages.

Icon	Description
 * Charging	Automatically tests, charges, and makes a decision on a battery using the information inputted by the user in a series of screens. Generates a test code for all decisions.
 13.5V Power Supply	Power Supply Mode: Tests and maintains battery voltage at 13.5 volts to allow for uninterrupted reflashing of vehicle's computers or to retain vehicle system settings.
 System Test	Perform a test on a vehicle including Battery and determine Starter Cranking voltage. Generates a test code for all decisions.
 Print/View	Displays the last battery test results. Sends the results to the printer.
 * Info	Includes a utility to view and print test results, a total test counter, a data transfer utility, and the software version and date, and charger serial number for the Control Module.
 * Utility	Setup utilities lets the user customize the charger interface. Includes administrative functions.

Charging Menu



 The Charging Menu provides several charging options: Diagnostic Charging, Jump Start, and Manual Charging.

Icon	Description
 Diagnostic	Select for optimum battery testing and SOH in the shortest possible time to ensure battery performance for customer vehicles or vehicles on the lot. Generates a test code for all decisions.
 Jump Start	Makes high output current available to boost charge an in-vehicle battery and assist in starting the engine.
 Manual	Provides a timed charge that ranges from 5 to 120 minutes or a continuous charge that ends when the STOP button on the Control Module is pressed.

Info Menu





The Info Menu has utilities to help manage test data, view and print test results, track the usage and history of the charger.

Icon	Description
 Totals	Reports menu that includes the following type of test totals: LIFETIME, USER TOTALS, LAST 100 LOG, and TOTALS BY DECISION.
 Version	Displays the software version and release date, and the serial number of the Control Module.

Print/View Menu









The tester stores the last battery, system, and cable test results in its memory until another test is performed. This function can also be used to send test data through a connected WiFi network.













Icon	Description
 View Test	Displays the last Battery and System Test results. Sends the results to an optional IR printer.
 * Send Data	Transmit test data via the charger's WiFi network connection.

Utility Menu





The Utility Menu lets users customize charger default options. Before using the charger for the first time, check the default values to see what options may need to be changed, added, or deleted.

Icon	Description
 Clock	Settings to adjust date and time.
 Users	Add, edit, or delete User IDs.
 Skip	Allows users to add a custom header to printed test results.
 Display	Settings to adjust the screen contrast and backlight time.
 Coupon	Enable or disable the inclusion of a coupon(s) created using the Edit Coupon function to be printed on test results.
 Edit Coupon	Create and store up to three separate coupons to be printed on test results.

Icon	Description
	Sets the language of the display and printouts.
	Select degrees in Fahrenheit or Celsius as the default temperature measurement units.
	Updates the charger software via files on a data card.
	Formats the data card to receive data. Also erases all data on the card.
	Updates the charger software using files on an data card.
	Select between an internal printer or an IR external printer. (Internal printer optional)
	Turns buzzers alert on or off.
	Use the Dealer Number function to enter the number of the dealership where the charger is registered.
	Use the WiFi Disable function to enable or disable data communications over the selected WiFi network.
	Use this function to find and configure the tester's connection to a local WiFi network.
	The IP Setup function allows the IP configuration of the tester WiFi radio to be configured manually.
	Use the CVG function to connect and synchronize the CVG module with the WiFi equipped GR8-1100 diagnostic charger.

Conventions Used In This Manual

To help learn how to use the GR8-1100 EST, this manual uses these symbols and typographical conventions:

Convention	Description
	The safety symbol indicates instructions for avoiding hazardous conditions and personal injury.
	The safety symbol with the words CAUTION , WARNING , or DANGER indicates instructions for avoiding hazardous conditions and personal injury.
CAUTION	The word CAUTION indicates instructions for avoiding equipment damage.
	The wrench symbol indicates procedural notes and helpful information.
CAPITAL LETTERS	The text for screen options are in regular capital letters.
BACK ARROW	The text for soft keys are in Bold capital letters.

Initial Start-up

When the charger is plugged in and turned on for the first time, it will prompt the user to enter the six-digit Dealer Number and adjust the charger's internal clock. The charger's WiFi network settings can also be enabled and configured. See Chapter 7: Utility for more information.

After the initial settings have been entered into the charger, the Main Menu is displayed on the Control Module screen.

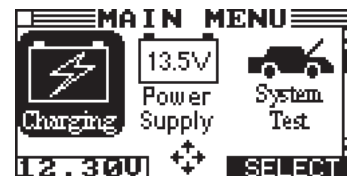

Preparing to Charge

Inspecting the Battery

Before starting the test, visually inspect the battery for:

- Cracked, buckled, or leaking case. If any of these defects are visible, replace the battery.
- Corroded, loose, or damaged cables and connections. Repair or replace as needed.
- Corrosion on the battery terminals, dirt, or acid on the case top. Clean the case and terminals using a wire brush and a mixture of water and baking soda.
- Low electrolyte level. If the electrolyte level is too low, add distilled water to the level indicated by the battery manufacturer, and fully charge the battery. Do not overfill.
- Corroded or loose battery terminals, tray and hold-down fixture. Tighten or replace as needed.

Connecting the Clamps

Connect the charging clamps to the battery in accordance with all precautions and safety instructions. **Do not connect either clamp to the vehicle's chassis.**

Connecting to AC Power

Plug the charger into a dedicated, grounded nominal 15-amp or higher AC outlet. Press the power switch to the **ON** position.

If the clamps are not making good contact with the battery posts, the Control Module displays CHECK CLAMP CONNECTIONS. Make sure that both jaws of each charging clamp come in good contact with the battery posts.

The charger will sound an alarm and display "Charger Clamps Reversed" if the clamps are reversed on the battery terminals.

Setting User Preferences

Before starting a test with the charger, by setting preferences in the Setup Menu. The setup utilities are described in Chapter 7: Utilities.

Go to Chapter 8: Maintenance & Troubleshooting in this manual for more information about the default settings and user preferences built into the GR8-1100 EST.

Chapter 2: Charging



Charging

The Charging menu has three options for charging a battery: Diagnostic mode, Jump Start mode, and Manual mode.



IMPORTANT: When you start a new charge session, the last test results in memory will be overwritten. Remember to record or print the results if you need to retain them.

Diagnostic



Diagnostic

Diagnostic Charging has four modes that the charger may use to determine the State-of-Health of the battery while bringing it to a full State-of-Charge.



IMPORTANT: When you start a new charge session, the last test results in memory will be overwritten. Remember to record or print the results if you need to retain them.

- ① **Initial Analysis:** The charger first analyzes the battery and makes a decision: REPLACE BATTERY (or REPLACE-BAD CELL) or GOOD BATTERY. A test code appears for all decisions.
- ② **Diagnostic Mode:** Once the charger determines that the battery is good, needs charging, and is safe to charge, it proceeds to Diagnostic Charge Mode. During the charging session, the charger provides updates of the charging voltage, charging current, remaining time to charge, charging mode, and the amount of charge replenished into the battery in amp-hours. The charger continues to test the battery throughout Diagnostic Mode and may determine at some point that the battery needs to be replaced.

Following the Diagnostic Charge Mode process the charger will prompt you to stop the process or continue on in Top-Off Mode. After two minutes the charger will automatically enter Top-Off mode if there is no user input.
- ③ **Top-Off Mode:** This mode occurs automatically at the end of the charge cycle to allow the charger to fill a good battery to capacity. Top-Off Mode ends when the battery's acceptance of the charge current goes below 2 amps, or when you press the **STOP** button.
- ④ **Recovery Mode:** In some cases, the charger automatically switches to Recovery Mode in an attempt to recover a hard-to-charge battery.

A test code is generated for all final decisions.

Make sure all vehicle accessory loads are off, the key is not in the ignition, and the doors are closed.

1. At the Main Menu highlight the Charging icon and press the **SELECT** key.
2. At the Charge Menu highlight the Diagnostic icon and press the **SELECT** key.
3. If prompted, use ▲ or ▼ to select a User ID and press **NEXT** or press the corresponding number key.
4. Use ▲ or ▼ to select the LOCATION and press **NEXT** or press the corresponding number key.
 - 1 OUT OF VEHICLE
 - 2 IN VEHICLE
5. Use ▲ or ▼ to select the BATTERY TYPE and press **NEXT** or press the corresponding number key.
 - 1 FLOODED
 - 2 AGM
 - 3 AGM SPIRAL
6. Use ▲ or ▼ to select the UNITS and press **NEXT** or press the corresponding number key.
 - 1 CCA
 - 2 JIS

Rating	Description	Range
CCA	Cold Cranking Amps (specified by SAE): The amount of current a battery can provide at 0 °F (-17.8 °C).	100 to 3000
JIS	Japanese Industrial Standard: (shown on a battery as a combination of numbers and letters.	55D23 65D23 75D23 N-55

7. Press ▲ or ▼ to select the BATTERY RATING or use the numeric keys and press **NEXT** to continue.

If CCA, use the keypad or scroll to the rating and press **SELECT**. The entry range is 100 to 3000, except for DIN and IEC, which have a range of 100 to 1000.



If JIS, scroll to the JIS number.

When you select the last charge parameter the charger begins the initial battery analysis.



If additional testing is required, progress is shown by a clockwise-filling pie graph.



8. If IN VEHICLE was selected in step 4, use ▲ or ▼ to select the VIN ENTRY method for the vehicle being tested and press **NEXT** or press the corresponding number key.
 - 1 USE CVG
 - 2 MANUAL ENTRY

For USE CVG: Turn the vehicle ignition to the "On" position, but do not start the vehicle and insert the CVG into the OBD port. The port is usually located on the driver's side under the dashboard.

Press **NEXT** when the blue LED on CVG illuminates. If the VIN is found in the database, the number is displayed on the Control Module screen. If still not found after cycling the CVG power, select MANUAL ENTRY to enter the VIN.

NOTE: Automatic VIN retrieval is only available on 2008 and newer Subaru vehicles.

For MANUAL ENTRY: Use the keypad to enter the full VIN of the vehicle using the battery being tested. To enter letters, repeatedly tap the alphanumeric key to cycle through its associated characters.



Alternatively, use the **ARROW** keys to highlight individual characters and numbers of the VIN and press **SELECT** to add them to your line of text. Press **BACK** to return to the Main Menu.

Once the complete VIN has been entered, the **BACK** option is replaced by **NEXT**. Delete one of the VIN digits and then press **BACK** to return to the Main Menu.

Diagnostic Charging

If the charger determines that the battery has an insufficient State-of-Charge, it automatically begins Diagnostic Charge Mode. During the charge session the charger controls the charging voltage, current and duration based on its continual analysis of testing and charging data, and the selected battery parameters.

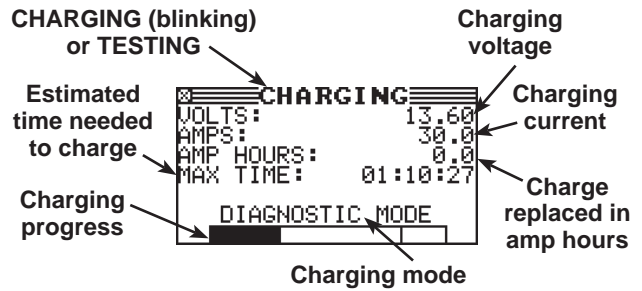

NOTE: The actual time needed to charge the battery may be less than the estimated time depending on the battery's charge acceptance.

When the battery requires testing, the display alternates between the CHARGING and TESTING screens. The TESTING screens represent a two-step process:

Step 1: The charger applies an electrical load and tests the battery's response.



Step 2: The charger measures the battery's CCA.



Aborting a Charge Session

If you need to abort the charging session, press and hold the **STOP** key until the charging session is aborted. You will not be able to obtain a test code for an uncompleted charge. After aborting, select **NEXT** to return to the Main Menu.

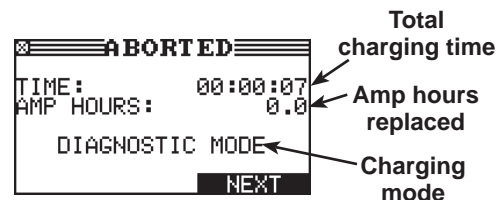

Completing a Charge Session

The charge session is complete when the proper amount of charge is put back into the battery or the remaining estimated time to charge counts down to zero.

If the charger finds that the battery is bad before the end of the estimated time to charge, it displays the decision REPLACE BATTERY or REPLACE-BAD CELL and the results.

When the decision is GOOD BATTERY, the charger gives you the option of topping off the battery's charge level before it displays the results.

Top-Off Mode

Top-off charging fills a good battery to capacity after a completed charge session. The charger gives you the option of selecting **YES** to proceed to Top-Off at any time or **NO** to display the results.

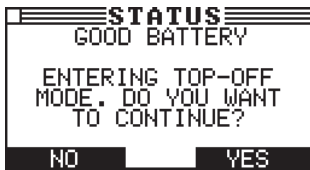

If you make no selection within two minutes, the charger automatically begins Top-Off Mode.

You have the option of stopping Top-Off Mode at any time by pressing the **STOP** key or allowing the charger to complete the charging. When Top-Off Mode is complete, the alarm sounds every 30 seconds until you press **STOP**.



Press **NEXT** to display the diagnostic charging results.

Diagnostic Charging Results

Test results are displayed across multiple screens. Use ▲ or ▼ to scroll to each screen. To return to the Main Menu, press **EXIT**. To print, press **PRINT**.

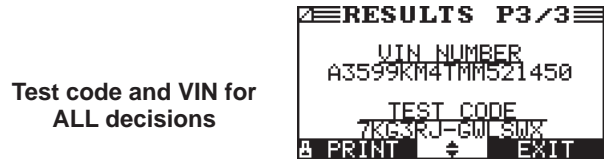
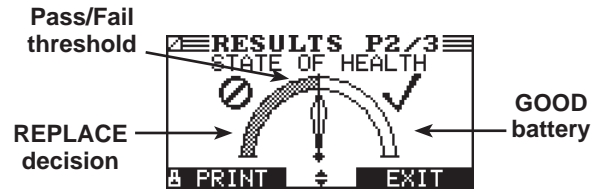
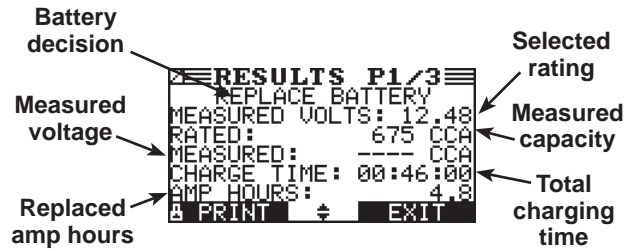

Use ▲ or ▼ to scroll to each screen. To return to the Main Menu, press **EXIT**. To print, press **PRINT**.



IMPORTANT!: When you start a new test, the last battery test in memory will be overwritten. Remember to record or print the results if you need to retain them.

Battery Decisions: Diagnostic Charge

Decision	Recommended Action
GOOD BATTERY	Return the battery to service.
REPLACE BATTERY	Before replacing the battery make sure battery cables and connections are clean and solid. If they are loose or corroded, clean and tighten, then retest.
BAD CELL-REPLACE	Replace the battery. This decision indicates a bad cell within the battery.

⚠ DANGER

Risk of explosive gases. Can cause death or serious personal injury.

Never attempt to charge a battery with a bad cell. The battery must be replaced.

State-of-Health (SOH)

Another factor affecting a battery's ability to crank an engine is its actual condition or State-of-Health (SOH). It is a measure of the battery's condition relative to a fresh battery. Based on cranking rating, open-circuit voltage, conductance (ability to deliver current) and battery temperature, the charger will qualify a battery as "good" or "bad" (should be replaced).

Although a State-of-Health problem can be the result of defects in construction, it is most often the result of normal wear-out mechanisms, which are dependant on vehicle needs, climate, and operating conditions. This results in irreversible physical and chemical changes until eventually the battery can no longer hold a charge and supply the power necessary to start the car and provide auxiliary power to the electrical system.

As the battery approaches end of life, its deterioration accelerates, until it finally fails to start the vehicle. Before failing, the battery may start the vehicle under normal conditions but may not be able to operate in more extreme conditions. Extreme heat or cold could expose a weak battery and cause it to fail.

Jump Start



This charging mode makes high output current available to boost charge an in-vehicle battery as well as assist in starting the engine. If you need to abort at any time, press **STOP**.

- In the Charging Menu use ◀ or ▶ to highlight the JUMP START icon and press **SELECT** to continue.
- Use ▲ or ▼ to select a User ID and press **NEXT** or press the corresponding number key.
- Use ▲ or ▼ to select the BATTERY TYPE, or press the corresponding number key.
 - FLOODED
 - AGM
 - AGM SPIRAL
- The charger will perform a series of tests to determine if the battery is safe to charge. After the tests have been successfully completed and the battery has passed, press **NEXT** to begin the boost charge.
- The charger begins boost-charging. Do not crank the engine at this time.
- Following a successful boost charge, the charger displays CRANK ENGINE NOW, sounds a warning tone, and flashes the status light. You can now crank the engine for up to five seconds.
- When the charger displays "JUMP START COMPLETE," press **STOP** key. (The warning tone sounds every second until you press **STOP**.)

Manual Charging



The charger charges the battery based on the current limit or voltage limit, and charge duration that you select. Because the charger makes no battery test decisions in this mode, it does **not** produce a test code.

⚠ CAUTION

You must monitor the battery's State-of-Charge (SOC) and temperature to avoid overcharging.

Any charging after the battery is fully charged can result in excessive battery temperature, which will "gas" the battery and boil off electrolyte, shortening battery life.

- In the Charging Menu use ◀ or ▶ to highlight the MANUAL icon and press **SELECT**.
- Use ▲ or ▼ to select a User ID and press **NEXT** or press the corresponding number key.
- Use ▲ or ▼ to select the LOCATION and press **NEXT** or press the corresponding number key.
 - OUT OF VEHICLE
 - IN VEHICLE
- Use ▲ or ▼ to select a BATTERY TYPE and press **NEXT** or press the corresponding number key.
 - FLOODED
 - AGM
 - AGM SPIRAL
- Use ▲ or ▼ to select the LIMIT TYPE and press **NEXT** or press the corresponding number key.
 - LIMIT CURRENT
 - LIMIT VOLTAGE
- Use ▲ or ▼ to set the limits for VOLTAGE or CURRENT and press **NEXT**.

If your limit type is CURRENT, select the maximum amperage (1 to 60 amps). When in doubt, start with a low charging current.

10  AMPS

If your limit-type is VOLTAGE, select the maximum voltage. The range for flooded is 12.7 to 15.3 V; AGM is 12.7 to 14.4 V.

12.40  VOLTAGE

- 7. Select a charge duration from 5 to 120 minutes, or select a duration greater than 120 minutes for Continuous charging. To select a timed charge when "CONTINUOUS" is displayed, use the key pad to enter a duration 5 and 120 minutes.

Continuous charging stops when you press **STOP**.

Timed Charge

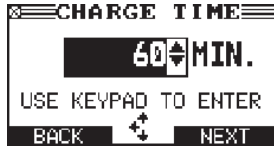

Continuous Charge



NOTE: The charger tests the battery to determine if it is safe to charge. If it detects that the battery is defective, it displays a warning that the battery is unsafe to charge. Press **EXIT** to return to the Main Menu.

- 8. If the battery is safe to charge, the charger will begin charging at the selected levels. The illustration shows an example of the information displayed during timed charging.

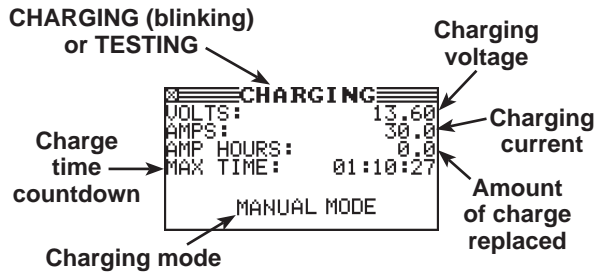

NOTE: If Continuous charge is selected, charging time is not displayed.

- 9. When Manual Mode ends, the charger displays the total charging time for Continuous and Timed Charging, the amp hours replaced, and the charging mode.

The alarm sounds every 30 seconds until you disconnect the clamps, or press **NEXT**.



Chapter 3: Power Supply Mode



Power Supply Mode tests and maintains battery voltage in the vehicle at 13.5 volts to allow for uninterrupted reflashing of vehicle computers, retain vehicle system settings, or maintain battery voltage.



IMPORTANT! Before starting Power Supply Mode, verify that all vehicle loads are off and the key is not in the ignition.



NOTE: Start the Power Supply Mode before beginning the Control Module reflashing process.

- Use ▲ or ▼ to highlight the Power Supply Mode icon and press **NEXT** to continue, or press the corresponding number key.
- Connect the clamps to the battery terminals.
- In the Options Menu use ◀ or ▶ to highlight the POWER SUPPLY icon and press the **SELECT**.
- Use ▲ or ▼ to highlight the correct USER ID and press **NEXT**.
- Use ▲ or ▼ to select the BATTERY TYPE and press **NEXT** to continue, or press the corresponding number key.
 - FLOODED
 - AGM
 - AGM SPIRAL
- Press ▲ or ▼ to select the BATTERY RATING and press **NEXT** to continue, or press the corresponding number key.

500  CCA

- Before entering the Power Supply Mode, the charger will test the battery to determine if it needs to be charged. A Warning message is displayed if the battery does not have a sufficient charge.

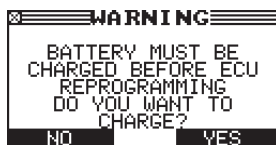

NOTE: If you choose to charge the battery, you will need to restart the Power Supply Mode once the battery has been successfully charged.



NOTE: The charger tests the battery to determine if it is safe to charge. If it detects that the battery is defective, it beeps, flashes the status light, and displays a warning that the battery is unsafe to charge. Press **EXIT** to return to the Main Menu.

- If the battery is safe to charge, the charger begins maintaining the battery voltage at 13.5 volts.

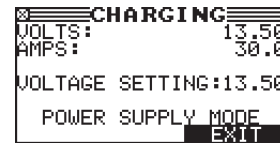

NOTE: Amperage fluctuates in response to the vehicle's demands.

If the voltage drops below the 12.8, the charger displays a warning and raises the voltage to the set point.

- When finished servicing the vehicle, press the **STOP** button or the OFF switch, unplug the power cord and disconnect the clamps.

Chapter 4: System Test



The System Test requires the use of the Amp Clamp function. In this mode, a System Test provides a diagnosis of the vehicle's electrical system.



IMPORTANT: Battery test code, starter code and alternator code are only provided at the end of a complete system test.



NOTE: Make sure the vehicle being tested has been warmed up to normal operating temperature prior to performing a System Test.

1. In the Main Menu, highlight the SYSTEM icon and press the **SELECT** key.
2. If enabled, use ▲ or ▼ to select a User ID and press **NEXT** or press the corresponding number key.
3. Verify that the vehicle cables are in good condition and are clean, then press **NEXT** to continue.
4. Use ▲ or ▼ to select the BATTERY TYPE and press **NEXT** or press the corresponding number key.
 - 1 FLOODED
 - 2 AGM
 - 3 AGM SPIRAL
5. Use ▲ or ▼ to select the UNITS and press **NEXT** or press the corresponding number key.
 - 1 CCA
 - 2 JIS

Rating	Description	Range
CCA	Cold Cranking Amps: The amount of current a battery can provide at 0 °F (-17.8 °C).	100 to 3000
JIS	Japanese Industrial Standard.	55D23 65D23 75D23 N-55

6. Press ▲ or ▼ to select the BATTERY RATING or use the numeric keys and press **NEXT** to begin the System Test.

If CCA, use the keypad or scroll to the rating and press **SELECT**. The entry range is 100 to 3000, except for DIN and IEC, which have a range of 100 to 1000.



If JIS, scroll to the JIS number.

7. The initial battery analysis is displayed on the screen.



The charger may determine the battery being tested requires charging.

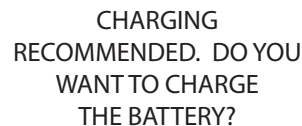

Press **NO** to skip charging the battery and continue with the System Test. Press **YES** to charge the battery before proceeding with the System Test.

8. Use ▲ or ▼ to select the VIN ENTRY type of vehicle being tested and press **NEXT** or press the corresponding number key.

- 1 USE CVG
- 2 MANUAL ENTRY

9. For **USE CVG**: Turn the vehicle ignition to the "On" position, but do not start the vehicle and insert the CVG into the OBD port. The port is usually located on the driver's side under the dashboard.

Press **NEXT** when the blue LED on CVG illuminates. If the VIN is found in the database, the number is displayed on the Control Module screen. If still not found after cycling the CVG power, select MANUAL ENTRY to enter the VIN.

For **MANUAL ENTRY**: Use the keypad to enter the full VIN of the vehicle using the battery being tested. To enter letters, repeatedly tap the alphanumeric key to cycle through its associated characters.

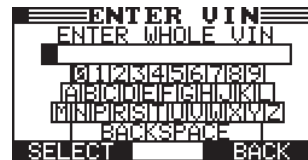

Alternatively, use the **ARROW** keys to highlight individual characters and numbers of the VIN and press **SELECT** to add them to your line of text. Press **BACK** to return to the Main Menu.

Once the complete VIN has been entered, the **BACK** option is replaced by **NEXT**. Delete one of the VIN digits and then press **BACK** to return to the Main Menu.

- If the entered VIN is not in the database, use ▲ or ▼ to enter the alternator amp rating (10 to 300A) and press **NEXT** to continue or press the corresponding keys on the keypad.



- If prompted, connect the Amp Clamp to the rear port of the Load Module.
- Zero the Amp Clamp following the onscreen instructions, making sure the clamp jaws are completely closed during the procedure. Then place it around the positive (+) alternator cable within 3" of the alternator if possible.



NOTE: For optimal results, the Amp Clamp needs to be as close to the alternator as possible to during the test.

CAUTION

Beware of moving engine parts and drive belts.
Make sure the Amp Clamp cable is clear of any moving engine parts to prevent any possible damage to the cable or the diagnostic charger.

Press **NEXT** to continue.

- Remove the Control Module from the top of the charger and take it to the interior of the vehicle being tested. Press **NEXT** to continue.
- When prompted, turn the vehicle's ignition on, but do not start the vehicle. Make sure all electric loads are off at this time. This will verify the Amp Clamp and CVG are correctly connected.



NOTE: The System Test can continue without the use of the CVG.

- Once the vehicle loads are off and the Amp Clamp has detected the correct amount of current, start the vehicle's engine when prompted.
- With the vehicle loads off, gradually rev and hold the engine to 3,000 RPM until the radiator cooling fan comes on twice, then idle the engine. The charger tests the alternator output at idle.
- With the vehicle loads off, gradually rev and hold the engine to 3,000 RPM.
- IDLE ENGINE: Press **NEXT** to continue.
- TURN IGNITION OFF: when prompted.
- REMOVE CVG: from the OBD port and press **NEXT** to continue.
- SLIDE THE GR8 CONTROLLER BACK ON TO THE GR8: Slide the Control Module (Controller) onto the bracket on the Charge Engine. Press **NEXT** to send data through the WiFi network and to display the results on the Control Module screen.

System Test Results

The System Test results are displayed across multiple screens. Use ▲ or ▼ to scroll to each screen. To return to the Main Menu, press **EXIT**. To print, press **PRINT**.

Battery Test Results

Following a successful System Test, the first series of screens displays the results of the battery test.

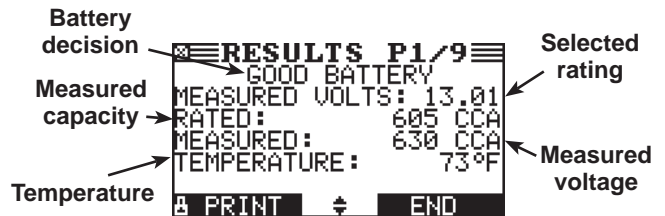

Pass/Fail threshold. Shaded area indicates a **REPLACE** decision.



Test code and Midtronics information code for **ALL** decisions.

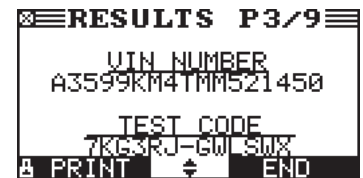

Battery Test Decisions

Decision	Recommended Action
GOOD BATTERY	Return the battery to service.
GR8 DIAGNOSTIC NEEDED	Fully charge the battery. Failure to fully charge the battery before testing may cause false readings.
REPLACE BATTERY	Before replacing the battery make sure battery cables and connections are clean and solid. If they are loose or corroded, clean and tighten, then retest.
BAD CELL-REPLACE	Replace the battery.
	<h2 style="margin: 0;">DANGER</h2> <p>Risk of explosive gases. Can cause death or serious personal injury.</p> <p>Never attempt to charge a battery with a bad cell. The battery must be replaced.</p>
NO VALID TEST	The test was stopped before it was completed.

Starter Test Results

The next series of screens displays starter test results.

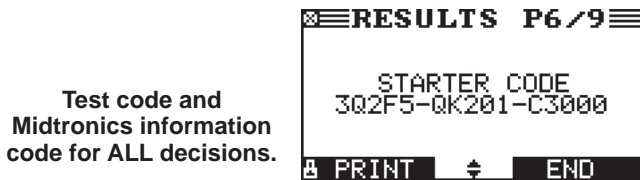
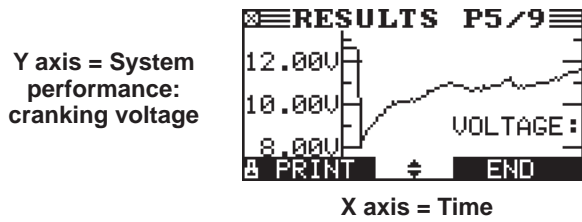
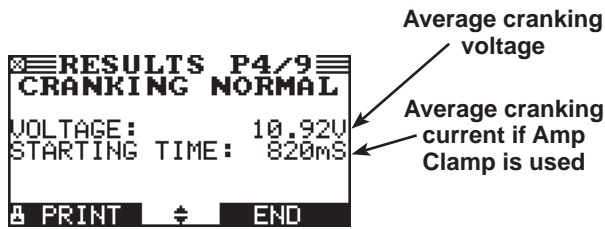

Alternator Test Results

The final series of screens displays alternator test results.

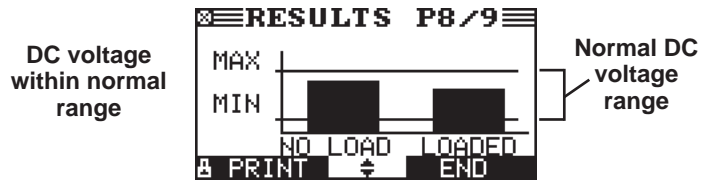
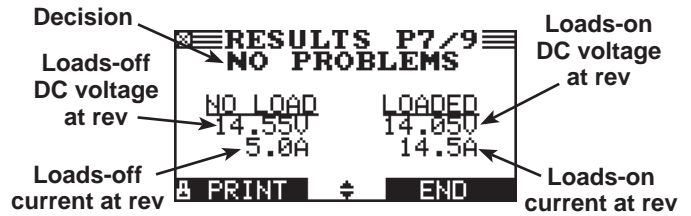

Starter Decisions

Decision	Recommended Action
CRANKING NORMAL	The starter voltage is normal and the battery is fully charged.
LOW VOLTAGE	The starter voltage is low and the battery is fully charged.
CHARGE BATTERY	The starter voltage is low and the battery is discharged. Fully charge the battery and repeat the starter system test.
REPLACE BATTERY	(If the battery test result was (REPLACE or BAD CELL). The battery must be replaced before testing the starter.
NO START	The engine didn't start and the test was aborted.
CRANKING SKIPPED	The charger didn't detect the vehicle's starting profile and skipped the Starter Test.



NOTE: After the Alternator Test is complete the resulting printout will contain all relevant test codes for the entire SYSTEM TEST process.

Alternator Test Decisions

Charging System Decision	Action
NO PROBLEMS	The system is showing normal output from the alternator. No problem detected.
NO VOLTAGE	<p>The alternator is not providing charging current to the battery.</p> <ul style="list-style-type: none"> √ Check the belts to ensure the alternator is rotating with the engine running. Replace broken or slipping belts and retest. √ Check all connections to and from the alternator, especially the connection to the battery. If the connection is loose or heavily corroded, clean or replace the cable and retest. √ If the belts and connections are in good working condition, replace the alternator. (Older vehicles use external voltage regulators, which may require only replacement of the voltage regulator.)
LOW VOLTAGE	<p>The alternator is not providing enough current to power the system's electrical loads and charge the battery.</p> <ul style="list-style-type: none"> √ Check the belts to ensure the alternator is rotating with the engine running. Replace broken or slipping belts and retest. √ Check the connections from the alternator to the battery. If the connection is loose or heavily corroded, clean or replace the cable and retest.
HIGH VOLTAGE	<p>The voltage output from the alternator to the battery exceeds the normal limits of a functioning regulator.</p> <ul style="list-style-type: none"> √ Check to ensure there are no loose connections and that the ground connection is normal. If there are no connection problems, replace the regulator. (Most alternators have a built-in regulator requiring you to replace the alternator. In older vehicles that use external voltage regulators, you may need to replace only the voltage regulator.) <p>The regulator controls voltage output based on the battery voltage, under-hood temperature, and vehicle loads used. In other words, it controls the maximum voltage the system can produce based on the current needs and amount of current that can be produced by the spinning of the rotor in the alternator. The normal high limit of a typical automotive regulator is 14.5 volts +/-0.5. Refer to the manufacturer specifications for the correct limit, which may vary by vehicle type.</p> <p>A high charging rate will overcharge the battery and may decrease its life and cause it to fail. If the battery test decision is REPLACE and the charging system test shows a HIGH OUTPUT, check the battery's electrolyte levels. A symptom of overcharging is battery fluid spewing through the vent caps, which causes low electrolyte levels and will harm the battery.</p>

Diode Decision	Action
EXCESSIVE RIPPLE	<p>One or more diodes in the alternator are not functioning or there is stator damage, which is shown by an excessive amount of AC ripple current supplied to the battery.</p> <ul style="list-style-type: none"> √ Make sure the alternator mounting is sturdy and that the belts are in good shape and functioning properly. If the mounting and belts are good, replace the alternator.
OPEN PHASE	The analyzer has detected an open phase within the alternator. Replace the alternator.
DIODE OPEN	The analyzer has detected a open diode within the alternator. Replace the alternator.
DIODE SHORT	The analyzer has detected an shorted diode within the alternator. Replace the alternator.

Chapter 5: Info



Use the Info Menu to view and print user test totals, test totals by decision, and system test totals. The charger software information is also found here.

To print, select the **PRINT** key. To return to the Main Menu, press **EXIT**.

Totals



Totals

The TOTALS function tracks test totals performed by the charger by user, by decision type, and by system test.

1. At the Info Menu, use ◀ or ▶ to highlight the Totals icon and press **SELECT**.
2. Use ▲ or ▼ to select the type of TOTALS to view and press **NEXT** or press the corresponding number key.
 - 1 USER TOTALS
 - 2 TOTALS BY DECISION
 - 3 SYSTEM TEST
3. Press **PRINT** to print the displayed results or **EXIT** to return to the Info Menu.

Version



Version

VERSION displays the charger software version details including the software release date and the serial number of the Control Module. This information can also be printed using the built-in printer in the Control Module.

1. At the Info Menu, use ◀ or ▶ to highlight the Version icon and press **SELECT**.
The charger software version information is displayed on the Control Module screen.
2. Press **PRINT** to print the displayed information or **EXIT** to return to the Info Menu.

Chapter 6: Print/View



Use the PRINT/VIEW function to view and print the most recent Diagnostic charging results and System Test results before they are overwritten by the next successfully completed test. Test data can also be transmitted via a connected WiFi network.



NOTE: If BMIS functionality is enabled and the tool is connected to the Midtronics server via a WiFi network and the Internet, test data can also be viewed and printed via the Midtronics BMIS website.

View Test



Selecting View Test will display the results from the last successful System Test or Diagnostic Charging session completed using the charger.

1. At the Print/View Menu, use ◀ or ▶ to highlight the View Test icon and press **SELECT**. The test results are displayed on the Control Module screen.
2. Use ▲ or ▼ to view each of the results screens. The number and type of results screens will vary depending on the last type of test completed.
3. Press PRINT to print out the results or EXIT to return to the Print/View reports menu.

Send Data



Use the Send Data function to manually transmit test data via a connected WiFi wireless network.



NOTE: If BMIS functionality is enabled and the tool is connected to the Midtronics server via a WiFi network and the Internet, test data is automatically transmitted following a successful diagnostic charging session.

1. At the Print/View Menu, use ◀ or ▶ to highlight the Send Data icon and press **SELECT**. The charger begins to transmit the test data.



A "Sending Data Passed" confirmation message is displayed following the successful transmission of the test data.

2. To end the test data transmission, press and hold **SKIP**. The Print View reports menu is displayed once the data transmission has been terminated.

Chapter 7: Utility



Use the Utility Menu to customize some of the basic functions of the diagnostic charger. This included the user interface default language of the user interface to the contrast of the display.

Clock



Use the CLOCK utility any of the six adjustable clock parameters.

```

TIME ZONE :      GMT -06:00
DST MODE :      ON
TIME :          9:07 AM
MODE :          AM/PM
DATE :          7/23/2013
FORMAT :        MM/DD/YYYY

```

Time Zone

1. Use ▲ or ▼ to select TIME ZONE and press **EDIT**.
2. Use ▲ or ▼ to select GMT time zone offset.



3. Press **SAVE** to save any changes or **BACK** to return to the CLOCK ADJUST screen without saving.

DST Mode

1. Use ▲ or ▼ to select DST MODE and press **EDIT**.
2. Use ▲ or ▼ to turn DST (Daylight Saving Time) ON or off and press **NEXT** to continue, or press the corresponding number key.
 - 1 ON
 - 2 OFF
3. Press **SAVE** to save your setting, or **BACK** to return to the CLOCK ADJUST screen without saving.

Mode

1. Use ▲ or ▼ to select MODE and press **EDIT**.
2. Use ▲ or ▼ to select 24-hour or 12-hour (AM/PM) clock, or press the corresponding number key.
 - 1 24 HOUR
 - 2 AM/PM
3. Press **SAVE** to save any changes or **BACK** to return to the CLOCK ADJUST screen without saving.

Time

1. Use ▲ or ▼ to select TIME and press **EDIT**.
2. Use ◀ or ▶ to highlight the hour, minutes, or AM or PM. To rapidly scroll, hold down ▲ or ▼.

9 : 19 PM

3. Press **SAVE** to save your setting, or **BACK** to return to the CLOCK ADJUST screen without saving.

Format

1. Use ▲ or ▼ to select the format of the date, or press the corresponding number key.
 - 1 MM/DD/YYYY (month/day/year)
 - 2 DD/MM/YYYY (day/month/year)
2. Press **SAVE** to save any changes or **BACK** to return to the CLOCK ADJUST screen without saving.

Date

1. Use ◀ or ▶ to highlight the month, day, or year. To rapidly scroll, hold down ▲ or ▼.

7 / 23 / 2013

2. Press **SAVE** to save any changes or **BACK** to return to the CLOCK ADJUST screen without saving.

Users



The USERS utility allows you to create and edit a USER ID with 1 to 6 alphanumeric characters and link it to a test counter. It also allows you to delete a USER ID and the associated test total and turn the USER ID function on and off.

Entering a New User ID

1. Use ▲ or ▼ to select ENTER/EDIT and press **NEXT** to continue, or press the corresponding number key.
 - 1 ENTER/EDIT
 - 2 DELETE
 - 3 ON/OFF

- Use ▲ or ▼ to scroll to the ID placeholder you want to use and press **SELECT** to edit it.

Scrolling past the first line displays the previous screen. Scrolling past the fourth line displays the next screen. To display more placeholders, continue scrolling or use ◀ or ▶ to jump up or down through the list five lines at a time.

```

1 USER01
2 USER02
3 USER03
4 USER04

```

- To clear the default characters, press ◀. To add a space, move the cursor forward by pressing ▶.

```

ENTER USER ID
USER01

```

- Display a character by pressing ▲ or ▼ on the keypad as many times as needed. Press **SAVE** to continue.

```

ENTER USER ID
LANCE

```

Deleting a User ID



NOTE: Placeholder USER IDs (i.e., USER03, USER04) cannot be deleted.

- Use ▲ or ▼ to select DELETE and press **NEXT** to continue.
 - ENTER/EDIT
 - DELETE
 - ON/OFF
- Use ▲ or ▼ to scroll to the ID placeholder you want to delete and press **DELETE**.

```

1 LANCE
2 JOHN
3 JASON
4 USER04

```

Scrolling past the first line displays the previous screen. Scrolling past the fourth line displays the next screen. To display more placeholders, continue scrolling or use ◀ or ▶ to jump up or down through the list five lines at a time.

On/Off

- Use ▲ or ▼ to select ON/OFF and press **NEXT** to continue.
 - ENTER/EDIT
 - DELETE
 - ON/OFF

- Use ▲ or ▼ to ON or OFF and press **NEXT** to continue, or press the corresponding number key.
 - OFF
 - ON

- Press **SAVE** to save any changes, or **BACK** to return to the Utility Menu without saving.

Shop



The SHOP utility allows you to create a header for your printed test results with your business location information when the Admin option 3-PRINT HEADER is selected.

Its three information screens contain 12 lines of text with a maximum of 17 characters per line.

Screen 1	Screen 2
1-YOUR SHOP NAME	5-YOUR COUNTRY
2-1000 ANY ST.	6-YOUR PHONE NUMBER
3-YOUR TOWN, STATE	7-WWW.WEBSITE.COM
4-YOUR POSTAL CODE	8-

- Press ▲ or ▼ to highlight the line you want to change. The cursor blinks to the right of the last character in the line. (The cursor is not visible if all character spaces are filled.)
- To erase a character, press ◀.
- Insert a character by pressing the alphanumeric key associated with the character as many times as needed. You can center text by inserting blank spaces with the ▶ key. If you pause momentarily, the cursor will automatically move to the right.



IMPORTANT: Be sure to erase any default characters on unused lines by pressing ◀.

- Press **SAVE** to save your setting or **BACK** to return to the SHOP INFO screen without saving the changes.

To help you edit and center your shop information, use the template in the Appendix of this manual to lay everything out before entering it into the tool.

Display



Use the Display to adjust the contrast level of the text on the Control Module display.

The contrast level is 0 (lightest) to 10 (darkest). To change it:

- Use ▲ or ▼ to adjust the contrast level up or down.

```

9 [contrast icon] (1-10)

```

- Press **SAVE** to save your setting or **BACK** to return to the LCD OPTIONS screen without saving the changes.

Coupon



Coupon

Use the COUPON utility to enable and disable custom coupons or messages created in the EDIT COUPON utility to be included on test result printouts.

- Use ▲ or ▼ to select the desired coupon option and press **SELECT** to continue, or press the corresponding number key.
 - COUPON 1
 - COUPON 2
 - COUPON 3
 - NO COUPON PRINTED
- Press **SAVE** to save any changes or **BACK** to return to the Utility Menu without saving the changes.

Edit Coupon



Edit Coupon

The EDIT COUPON utility allows you to create and store up to three promotional coupons or messages for your customers.

- Use ▲ or ▼ to select the coupon to edit and press **SELECT** to continue, or press the corresponding number key.
 - COUPON 1
 - COUPON 2
 - COUPON 3
- Press ▲ or ▼ to highlight the line you want to change. The cursor blinks to the right of the last character in the line. (The cursor is not visible if all character spaces are filled.)
- To erase a character, press ◀.
- Insert a character by pressing the alphanumeric key associated with the character as many times as needed. You can center text by inserting blank spaces with the ▶ key. If you pause momentarily, the cursor will automatically move to the right.



IMPORTANT: Be sure to erase any default characters on unused lines by pressing ◀.

- Press **SAVE** to save any changes or **BACK** to return to the SHOP INFO screen without saving the changes.

Temp



Temp

Use the TEMP utility to set the default units of measurement to Fahrenheit or Celsius.

- Use ▲ or ▼ to select the temperature units and press **SELECT** to continue, or press the corresponding number key.
 - DEGREES F
 - DEGREES C
- Press **SAVE** to save any changes or **BACK** to return to the Setup Menu without saving the changes.

Language



Language

Use the LANGUAGE utility to select the default language for the Control Module display and test result printouts.

- Use ▲ or ▼ to select the default temperature units and press **SELECT** to continue, or press the corresponding number key.
 - ENGLISH
 - ESPAÑOL
 - FRANÇAIS
- Press **SAVE** to save any changes or **BACK** to return to the Utility Menu without saving the changes.

Format



Format

Select this utility to format an SD-type data card to receive data or erase all data on the card. Select **YES** at the warning message to proceed with the formatting.

Update



Update

Use this utility to update the charger's internal software from either a connected WiFi network or an SD-type data card inserted in the data card slot on the Control Module.

- Use ▲ or ▼ to select where the update will come from and press **NEXT** to begin the update, or press the corresponding number key.
 - USE SD CARD
 - VIA WIFI



NOTE: Select VIA WIFI if BMIS functionality is enabled and the tool is connected to the Midtronics server via a WiFi network and the Internet.

- Press **BACK** to return to the Utility Menu without saving the changes.

Printer (Optional)



Use the Printer function to select between an external IR printer or an optional integrated printer (part no. A141) inserted into the Control Module.



NOTE: Test results can also be accessed and printed via the Midtronics BMIS website if tool's BMIS functionality is enabled and the tool is connected to the Midtronics server via a WiFi network and the Internet.

- Use ▲ or ▼ to select which printer to use for printing out test results and other information and press **PRINT** or press the corresponding number key.
 - IR PRINTER
 - INTEGRATED PRINTER
- Press **BACK** to return to the Utility Menu without print.

Buzzer



Use the Buzzer utility to enable or disable the chargers' audible warning buzzer tone and LED indicator on Control Module.

- Use ▲ or ▼ to ON or OFF and press **NEXT** to continue, or press the corresponding number key.
 - OFF
 - ON
- Press **SAVE** to save any changes, or **BACK** to return to the Utility Menu without saving.

Dealer Number



Use the Dealer Number function to enter and update the number assigned to your dealership.

- Use ▲ or ▼ to highlight the DEALER NUMBER icon and press **SELECT**.
- Using the keypad on the Control Module, enter the dealership number. Use ◀ to backspace.
- Press **SAVE** to save any changes, or **BACK** to return to the Utility Menu without saving.

WiFi Disable



Use the WiFi Disable function to turn access to any detectable WiFi networks on or off.

- Use ▲ or ▼ to select the desired WiFi option and press **NEXT** or press the corresponding number key.
 - DISABLE
 - ENABLE
- Press **SAVE** to save your setting or **BACK** to return to the Utility Menu without saving the changes.

WiFi Setup



This function allows you to find and configure the charger's connection to your local WiFi network.

Scan

- Use ▲ or ▼ to select the SETUP TYPE and press **NEXT** to continue.
 - SCAN
 - WIFICONF FILE
 - MANUAL

The tester searches for any detectable WiFi networks. A list of detected WiFi networks is then displayed on the charger screen.

- Select the network you want to use from the displayed WiFi list and press **NEXT**.

For NOT IN LIST enter the network name using the displayed character map.



Use the **ARROW** keys to highlight the desired alphanumeric character and press **SELECT** to select it. The selected character appears in the box above.

Select ↑ to access the lower case and symbol character maps.

Once all of the alphanumeric characters have been entered, press **NEXT** to continue. Press **STOP** to exit the character map and return to the SETUP menu.

- If the chosen network is password protected, use the keyboard to enter the password and press **NEXT**.

A confirmation message is displayed when the charger is successfully connected to the WiFi network.

- Press **EXIT** to return to the Setup menu.

WiFiConfig File

Select WIFICONF FILE to let the tool to read a WIFICONF FILE saved to an SD-type data card and has been inserted in the card reader on the tool.

- At the Setup Menu use the **ARROW** keys to select the WiFi Setup icon and press **SELECT**.
- Use **▲** or **▼** to select WIFICONF FILE and press **NEXT** to continue.
 - SCAN
 - WIFICONF FILE
 - MANUAL

The charger reads the file from the data card and configures the tool using the specified parameters.

If no file is found, an error message is displayed. Press **EXIT** to return to the Setup Menu.

Manual

Select MANUAL to manual setup the parameters required for connecting to your specific WiFi network.

- Use **▲** or **▼** to select the SECURITY TYPE of the network you want to use and press **SELECT**.
 - OPEN
 - WEP
 - WPA
 - WPA2
- Use the displayed character map to enter the network SSID.



Use the **ARROW** keys to highlight the desired alphanumeric character and press **SELECT** to select it. The selected character appears in the box above.

Select **↑** to access the lower case and symbol character maps.

Once all of the alphanumeric characters have been entered, press **NEXT** to continue. Press **STOP** to exit the character map and return to the Setup menu.

 **NOTE:** Consult your IT department for the specific technical parameters for your WiFi security protocol, including the name of the network, the encryption type, key, and password.

IP Setup



The IP Setup function allows the charger to be configured for your WiFi network. The specifications and parameters are usually configured by your IT technician.

CVG



Use the CVG function to enter or change the CVG serial number of the CVG used by the charger to extract information from the vehicle being tested.



NOTE: Entering and changing the CVG serial number requires access to any vehicle equipped with a properly functioning OBD connector.

- Use **▲** or **▼** to highlight the CVG icon and press **SELECT**.
- Using the keypad on the Control Module, enter the dealership number and press **NEXT**. Use **◀** to backspace.
- When prompted, turn the vehicle ignition on and connect the CVG to the OBD port. The port is usually located on the driver's side of the vehicle under the dashboard.



NOTE: Do not start the vehicle.

If necessary, cycle the CVG power by unplugging the module and plugging it back in. The CVG will beep and the blue LED will flash when successfully connected to the charger. A confirmation screen including the CVG serial number is displayed on the charger Control Module screen.



NOTE: Automatic VIN retrieval is only available on 2008 and newer Subaru vehicles.

- Press **EXIT** to the Utility menu.

Chapter 8: Maintenance & Troubleshooting

Help



The Help Menu has four functions to aid in the use of your analyzer including: Terms/Definitions, Troubleshooting and Service Info.

Terms/Definitions

The TERMS/DEFINITIONS option provides definitions for 22 terms used by the GR8-1100 EST battery diagnostic station.

- In the Help Menu, select the TERMS/DEFINITIONS option and press **ENTER**.

- 1 TERMS/DEFINITIONS
- 2 TROUBLESHOOTING
- 3 SERVICE INFO.

- Use **▲** or **▼** to highlight the term of your choice, or press the corresponding numbers on keypad.

1 - AGM SPIRAL
 2 - AGM
 3 - BATTERY TYPE
 4 - CCA

Press **ENTER** to view the definition.

- Use **▲** or **▼** to scroll through and read the full text definition.
- Press **BACK** to return to the list of terms.

Troubleshooting

The TROUBLESHOOTING option provides guidance to common questions or issues that may arise in using the station.

- In the Help Menu, use **▲** or **▼** to select the TROUBLESHOOTING option and press **ENTER** to continue, or press the corresponding number key.

1 - PRINTER HELP
 2 - CABLE PROBLEMS

- Use **▲** or **▼** to read the full text description.
 Press **BACK** to return to the previous screen.

Service Info

The SERVICE INFO option lists contact phone numbers for technical assistance and service issues.

Test Cable Maintenance

Here are a few things you can do to protect your test cables from damage and premature wear:

- The grease, dirt, and sulfation that build up on battery terminals are highly corrosive and can damage the clamps over time. Before connecting the clamps, ensure accurate test readings and protect the clamps by cleaning the battery case and terminals using a wire brush and a mixture of water and baking soda.
- Periodically clean the clamps using a mixture of baking soda and water, or a mild hand-soap, and a small bristle brush.
- Clean the battery terminals. If stud adapters are required, fasten them with the proper tool. Do not use the battery clamps to tighten adapters.
- Never remove the clamps from a battery to abort an active charging session. Always press the red **STOP** button before removing the clamps.
- Do not leave the clamps laying in battery acid.
- Hang the clamps on the cable wrap on the back of the charger when not in use.

Attaching the Charger Cables

The two connectors for the charger cables are located on the back of the charger. Three screws are included to secure the cables. To attach the cables:

1. Plug in the large connector (A), then plug in the small connector (B).

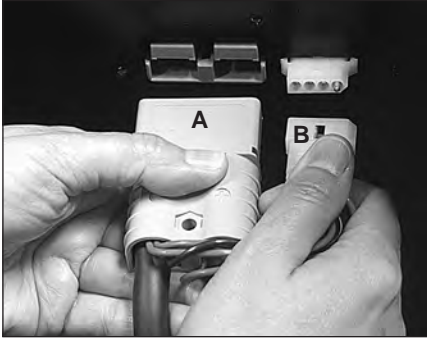

2. Slide the cover (C) down the cables until it seats against the sheet metal.

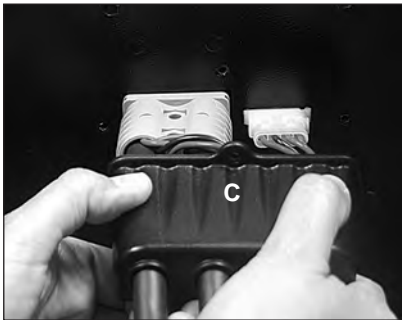

3. Insert the screws through the holes in the cover and sheet metal. Tighten the screws securely with a small screwdriver. (To remove the cables, use the attachment instructions in reverse.)



Test Messages

The table below will help you troubleshoot test messages. If troubleshooting does not solve the problem, call Midtronics Customer Service at 1.800.776.1995.

Message	Explanation
System Noise Detected	<p>The charger has detected computer, ignition noise, or parasitic drain, and will attempt to retest. Make sure all vehicle loads are off, doors are closed, and the ignition is in the off position. The charger will automatically retest when it no longer detects system noise. If the message reappears:</p> <ul style="list-style-type: none"> • You may be testing too close to a noise source, such as an arc welder or other high-current device. If so, move away and retest. • If you are unable to find the source of the noise, fully charge the battery and retest. If the message appears after recharging, test the battery out of the vehicle. • Disconnect the battery cables and retest.
Unstable Battery Detected	<p>A battery that is weak, or that has just been charged, may retain enough electrical activity to be detected by the charger and will adversely affect the test results. A fully charged battery should stabilize quickly, after which the charger will automatically retest. Weak batteries should be charged and retested. If the battery is fully charged, check the clamp connections.</p>

Error Messages

The table below will help you troubleshoot test messages. If troubleshooting does not solve the problem, call Midtronics Customer Service at 1.800.776.1995, between 7:00 a.m. and 5:00 p.m. Central Time.

MESSAGE	Option	EXPLANATION
VOLTAGE OUT OF RANGE! VALID RANGE 0 TO 16 VOLTS	Attention light flashes at 0.5 second intervals.	Tool detects incorrect voltage in battery test.
INVALID NUMERIC ENTRY	Less than 100 CCA or invalid date entry can cause this error. Attention light flashes at .5 second intervals.	Any edit box entry that exceeds the limits.
INTERNAL MEMORY ERROR! CALL MIDTRONICS CUSTOMER SERVICE 1-800-776-1995	Attention light flashes at 0.5 second intervals	Upon power up the tool detects a checksum error
REVERSE CONNECTION! CHECK POLARITY OF CLAMPS.	At power up or when reverse connection is made. For charger this can only occur at main menu or in a charger test screen	Tool will return to state that threw the error if the connection becomes valid. For charger both the bridge and Control Module will sound a steady tone until the error is corrected.
CONNECT RED CLAMP TO BATTERY POSITIVE (+) POST, CONNECT BLACK CLAMP TO BATTERY NEGATIVE (-) POST!	Clamp not connected Attention light flashes at 0.5 second intervals	Tool will return to state that threw the error if the connection becomes valid
CHARGER FAULT! CHECK CLAMPS! CHECK SERIAL CABLE!	Attention light flashes at 0.5 second intervals	Charger reported a fatal error.
CHARGER ERROR IS CHARGER TURNED ON? ARE CABLES CONNECTED?	This occurs if the bridge cannot talk to the charger.	Make sure the charger is turned on and the cables are connected.

Appendix

Shop Header And Coupon Templates

To help you edit and center your header, use the templates below to lay out your shop information below before entering it into the Battery Diagnostic Station.

Line 1																	
Line 2																	
Line 3																	
Line 4																	
Line 5																	
Line 6																	
Line 7																	
Line 8																	

Line 1																	
Line 2																	
Line 3																	
Line 4																	
Line 5																	
Line 6																	
Line 7																	
Line 8																	

Line 1																	
Line 2																	
Line 3																	
Line 4																	
Line 5																	
Line 6																	
Line 7																	
Line 8																	

PATENTS

This product is made by Midtronics, Inc., and is protected by one or more U.S. and foreign patents. For specific patent information, contact Midtronics, Inc. at +1 630 323-2800.

LIMITED WARRANTY

Midtronics products are warranted to be free of defects in materials and workmanship for a period of one (1) year from date of purchase. Midtronics will, at our option, repair or replace the unit with a re-manufactured unit. This limited warranty applies only to Midtronics products, and does not cover any other equipment, static damage, water damage, overvoltage damage, dropping the unit, or damage resulting from extraneous causes including owner misuse. Midtronics is not liable for any incidental or consequential damages for breach of this warranty. The warranty is void if owner attempts to disassemble the unit or to modify the cable assembly.

SERVICE

To obtain service, contact Midtronics at 1-800-776-1995 and press option 1. Have your model and serial numbers ready. This first step is critical as we will trouble-shoot the problem(s) over the phone, and many perceived problems are in fact resolved during this step. If the problem cannot be resolved, then the CS Agent will issue you a Return Material Authorization or RMA. This number becomes your tracking number. The final step is to return the unit to Midtronics freight prepaid (you pay), to the attention of the RMA number obtained.

In USA:

Midtronics, Inc.
Attn: RMA # xxxxx (this is the RMA number that you must obtain from Midtronics)
7000 Monroe St.
Willowbrook, IL 60527

In Canada:

Midtronics c/o FTN (FTN is Fed-ex Trade Networks –this is NOT a Midtronics facility)
Attn: RMA # xxxxx (this is the RMA number that you must obtain from Midtronics)
7075 Ordan Drive
Mississauga, ON L5T1K6

Midtronics will service the unit and reship the next scheduled business day following receipt (in most cases), using the same type carrier and service as received. If Midtronics determines that the failure was caused by misuse, alteration, accident, or abnormal condition of operation or handling, purchaser will be billed for the repaired product and it will be returned freight prepaid with shipping & handling charges added to the invoice. Midtronics products beyond the warranty period are subject to the repair charges in place at that time. Optional re-manufacturing service is available to return our products to like-new condition. Out-of-warranty repairs carry a 3-month warranty. Re-manufactured units purchased from Midtronics are covered by a 6-month warranty.



www.midtronics.com

Corporate Headquarters

Willowbrook, IL USA
Phone: 1.630.323.2800
Canadian Inquiries
Toll Free: +1 1 866 592 8053

Midtronics b.v.

European Headquarters
Houten, The Netherlands
Serving Europe, Africa, the Middle
East, and The Netherlands
Phone: +31 306 868 150

Midtronics China

China Operations
Shenzhen, China
Phone: +86 755 8202 2036

Midtronics India

Navi Mumbai, India
Phone: +91 22 27564103/1513

Asia/Pacific (excluding China)

Contact Corporate Headquarters
Phone: +1.630.323.2800