

Classification:

EL08-002f

Reference:

ITB08-021f

Date:

June 4, 2013

UPGRADING HDD NAVIGATION MAP DATA

This bulletin has been amended to correct the hyperlink on page 14.
 No other changes have been made to the body of this bulletin.
 Please discard previous versions.

APPLIED VEHICLES:	2007 – 2008 G35 Sedan (V36)	2009 FX (S51)
	2008 – 2009 G37 Coupe (CV36)	2008 – 2010 QX56 (JA60)
	2009 G37 Sedan (V36)	2008 – 2009 EX35 (J50)
	2009 G37 Convertible (HV36)	2008 – 2010 M (Y50)

SERVICE INFORMATION

The navigation system (if equipped) in the Applied Vehicles listed above has a HDD (Hard Disc Drive) map data storage system. This bulletin contains the information and instructions for updating/upgrading the map data with a new version.

An instruction manual for HDD Navigation Updates is also available in ASIST under Specialty Tools > HD Navi. Tools > Hard Drive Navigation Update Manual.

When new versions of map data are available, customers can purchase a Coupon Number via the internet at www.infinitinavigation.com or by calling NAVTEQ at 1-866-462-8837. The customer then takes their vehicle, along with the Coupon Number, to an Infiniti dealer to have the new version of map data installed into their navigation system. The time needed to install the new map data into the vehicle is approximately 30 minutes.

The HDD update kit (P/N: J-48850-A) is required to perform map data updates. One HDD update kit was shipped to each dealer as part of the essential tool program. See page 28 for kit details.

Make sure to use the newest Map Data Master Discs (2 disc set) when performing HDD Navigation Map Data Upgrades.

- As of the publication date of this bulletin, the newest disc set is 2013MY (12-13).
- Additional Master Discs are available from TECH-MATE at 1-800-662-2001.



Figure A

Infiniti Bulletins are intended for use by qualified technicians, not 'do-it-yourselfers'. Qualified technicians are properly trained individuals who have the equipment, tools, safety instruction, and know-how to do a job properly and safely. NOTE: If you believe that a described condition may apply to a particular vehicle, DO NOT assume that it does. See your Infiniti dealer to determine if this applies to your vehicle.

SERVICE PROCEDURE

IMPORTANT:

- Make sure your ASIST has been freshly synchronized and all C-III plus updates have been installed. The HDD (Hard Disc Drive) rewrite software is delivered via ASIST synchronization.
- Before the map upgrade can be performed, a Coupon Number must be purchased from www.infinitinavigation.com or by calling NAVTEQ at 1-866-462-8837.
- Before starting, it is recommend that you check the Current Map Version in the vehicle using the vehicle's navigation screen to make sure an upgrade is needed (see page 26).

Overview of the HDD (Hard Disc Drive) Map Upgrade

This procedure is divided into 7 sections. Complete each section in the following order:

SECTION 1: Installing the Update Map into the Consult PC.....	Page 3
(This is required only once for each new map version)	
SECTION 2: Connecting the Consult PC to the HDD Navigation System.....	Page 9
SECTION 3: Generating the Certification Number.....	Page 10
SECTION 4: Acquiring the Install Key.....	Page 14
SECTION 5: Upgrading the Map Data in the HDD Navigation System.....	Page 19
SECTION 6: Disconnecting the Consult PC and CF (Compact Flash) Adapter.....	Page 24
SECTION 7: Verifying the Upgrade Result.....	Page 26
• Checking Current Map Version in the Vehicle Using the Vehicle's Navigation Screen.....	Page 26
• HDD update kit (P/N: J-48850-A).....	Page 28

SECTION 1: INSTALLING THE UPDATE MAP INTO ASSIST

- Once the newest version is installed into the Consult PC it can be used to upgrade many HDD navigation systems. It is not necessary to install the updated map each time you perform a map data upgrade.
- If the newest map data is already installed in the Consult PC, you can skip to Section 2 on page 9.

1. Connect the DVD drive to the Consult PC with the USB cable.



Figure 1-1

2. Turn ON the Consult PC.
3. Open / start ASIST.

4. Select Specialty Tools, Then HD Navi. Tools.

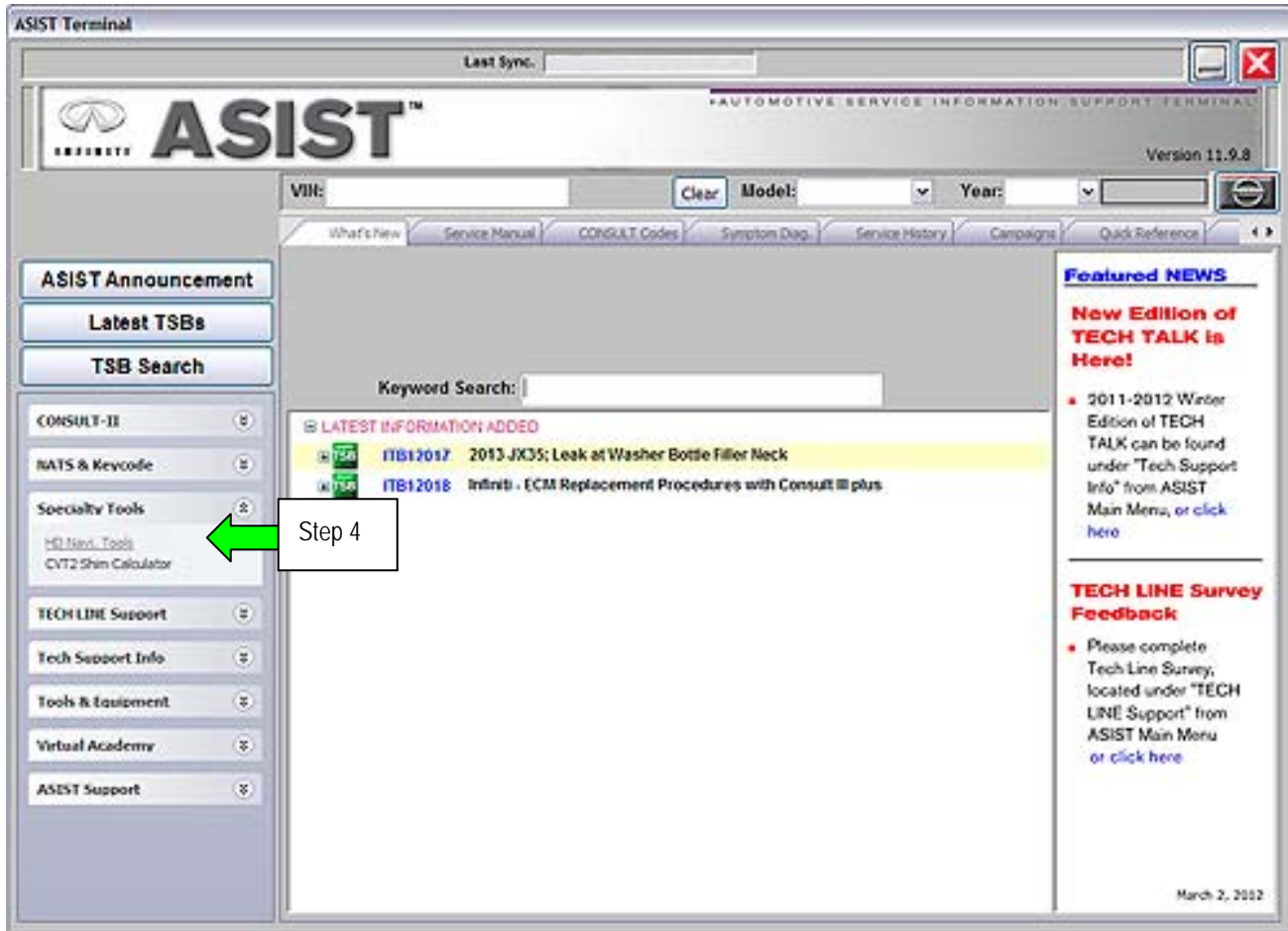

Figure 1-2

5. Select Install Map Update



Figure 1-3

6. Select **Installing updated map**

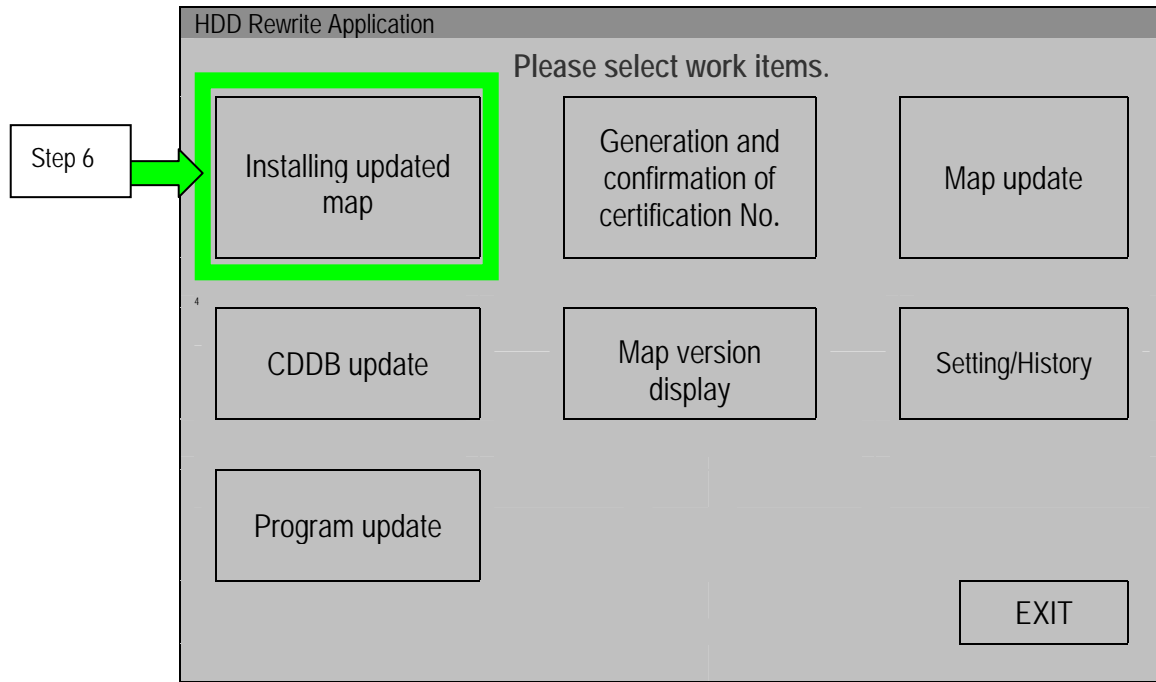

Figure 1-4

7. Insert the Map Data Master Disc 1 into the DVD drive.

8. Confirm the correct name of the DVD drive is displayed (see Figure 1-5).

- "E" is likely the correct name for the DVD drive.
- The DVD drive name may be different depending on the drive configuration of your Consult PC.

9. Select **START**

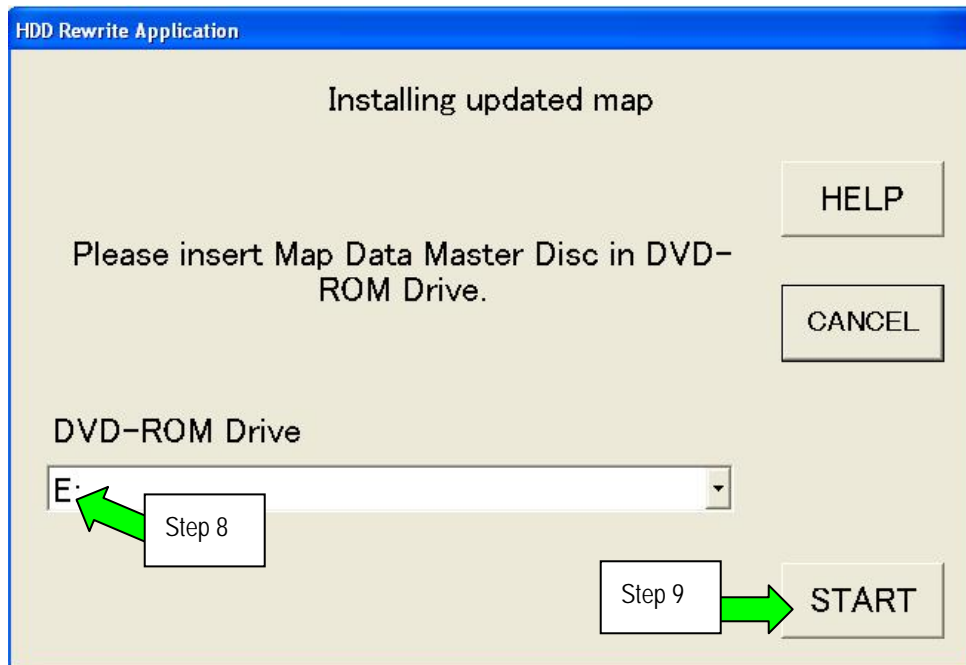

Figure 1-5

- Installation of the update map will start and a progress screen will display.
- Installation will take several minutes.

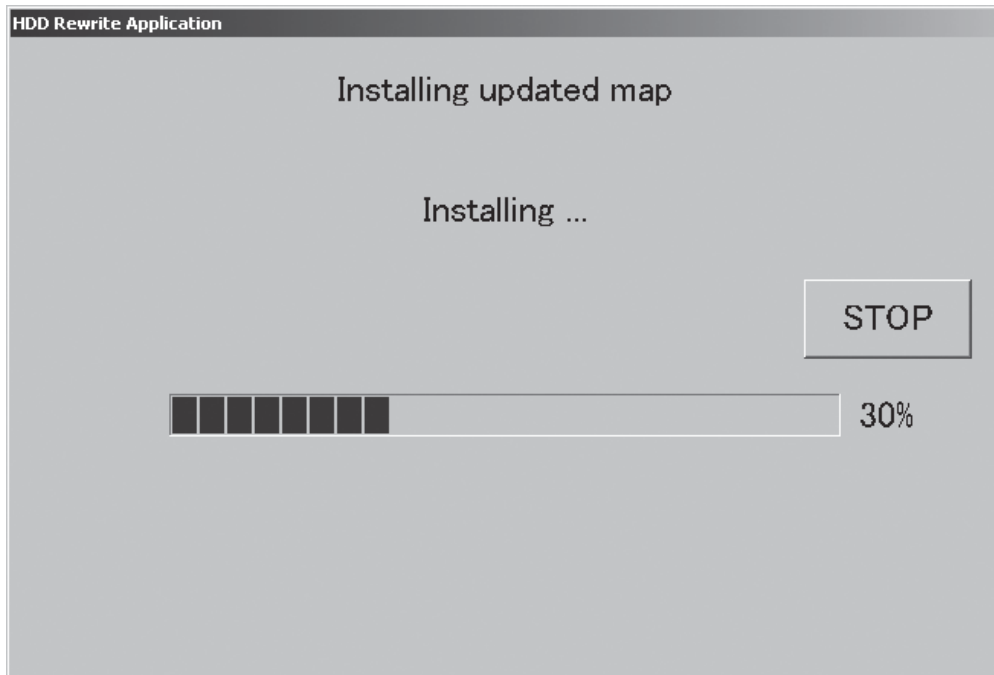

Figure 1-6

- At about 35% this message will display:

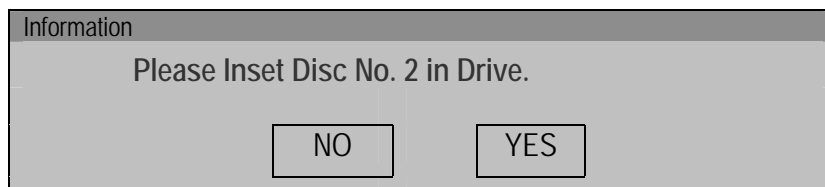

Figure 1-7

- When you get the above message, remove Disc 1; install Disc 2; then select YES.

- When installation is complete the screen shown in Figure 1-8 will display.

10. Select **OK**

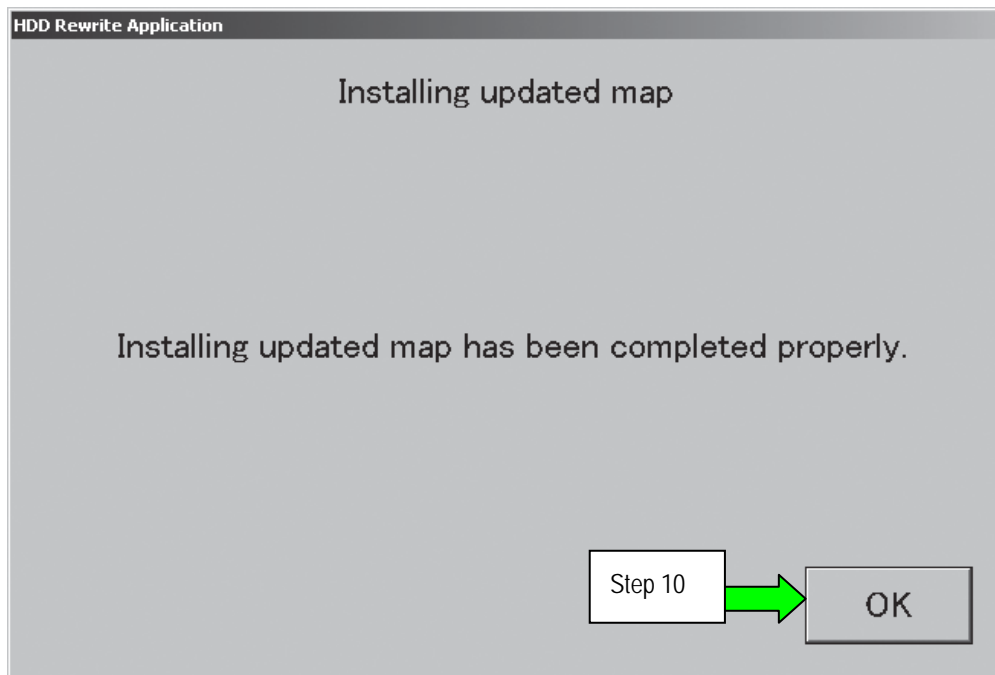

Figure 1-8

11. Select **EXIT**

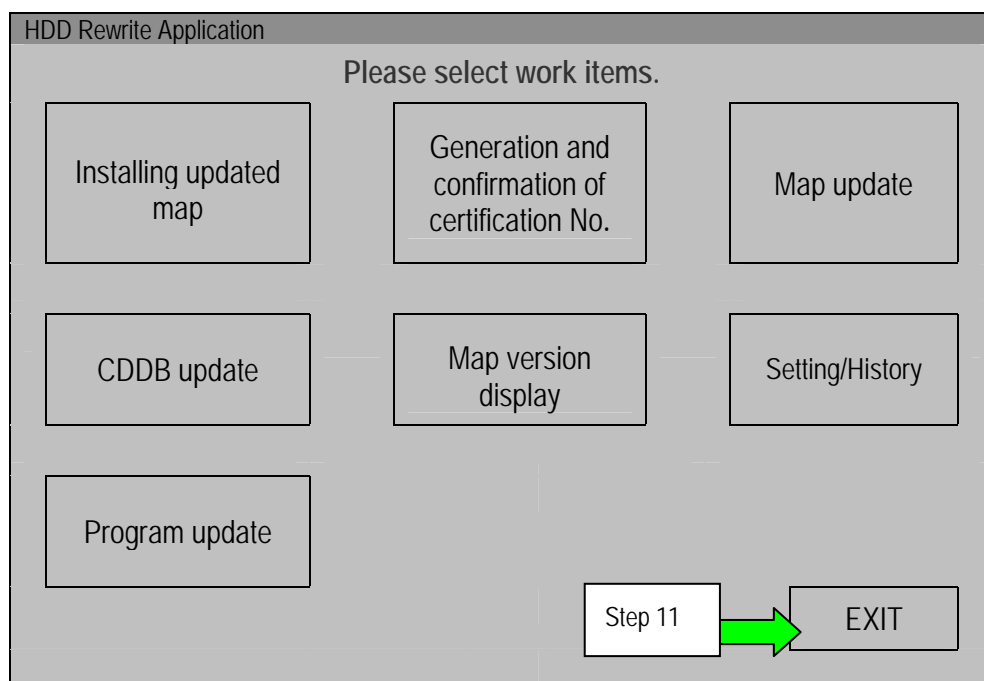

Figure 1-9

12. Remove Disc 2 from the DVD drive.

13. Select the **Safely Remove Hardware** icon on the “system tray” which is displayed in the bottom right of the Consult PC screen.

- You may need to click on the “expand arrow” to expand the icon selections.

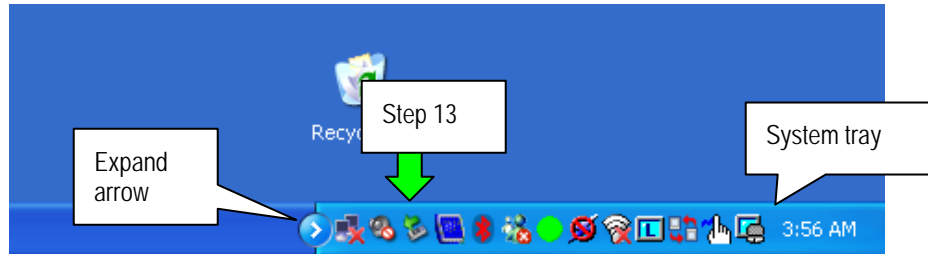

Figure 1-10

14. Select **Safely remove USB Mass Storage Device - Drive (E:)**

- The drive name will likely be E, but may be different depending on the drive configuration of your Consult PC.

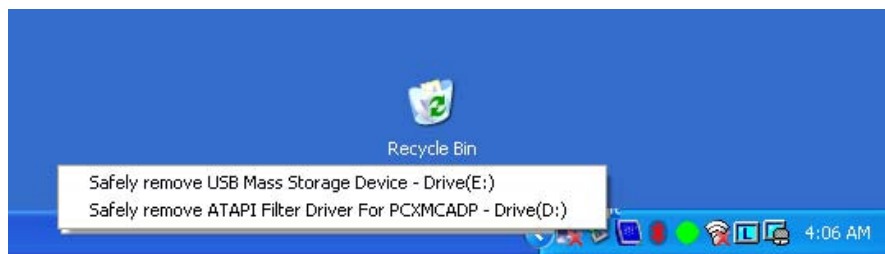

Figure 1-11

15. Disconnect the DVD drive from the Consult PC.



Figure 1-12

SECTION 2: CONNECTING the Consult PC TO THE HDD NAVIGATION SYSTEM

- All navigation components must be installed in the vehicle and connected correctly.
- Make sure the vehicle battery is charged and connected.
- Do not touch the CF (Compact Flash) adapter with wet hands.

CAUTION:

- **Do not turn the ignition ON** when the Consult PC is connected to the navigation system with the CF adapter.
- **Obey the following instructions**; otherwise the CF Adapter, CF card slot, or navigation system may be damaged.

1. Make sure the ignition is OFF.
 2. Close any applications that are running on the Consult PC.
 - If the Consult PC is OFF, leave it OFF for now.
 3. Connect USB cable to the Consult PC.
 - Make sure connector is fully inserted.



Figure 2-1

4. Connect the other end of the USB cable to the CF adapter.
 - Make sure connector is fully inserted.

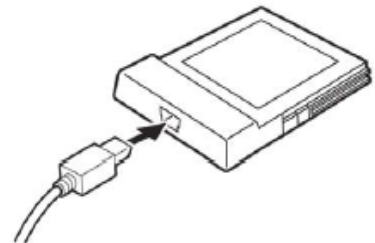

Figure 2-2

5. Carefully insert the CF adapter into the CF card slot of the vehicle audio/navigation system.
 - Label side should be UP.
 - Insert it all the way (firmly), to its stop.

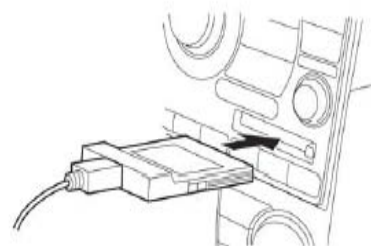

Figure 2-3

SECTION 3: GENERATING THE CERTIFICATION NUMBER

- The Certification Number is different for each HDD (Hard Disc Drive) navigation system. Make sure you are connected with the CF adaptor to the system (vehicle) that you will be updating.

1. Turn ON the Consult PC.
2. Open / start ASIST.
3. Select **Specialty Tools**, Then **HD Navi. Tools**.

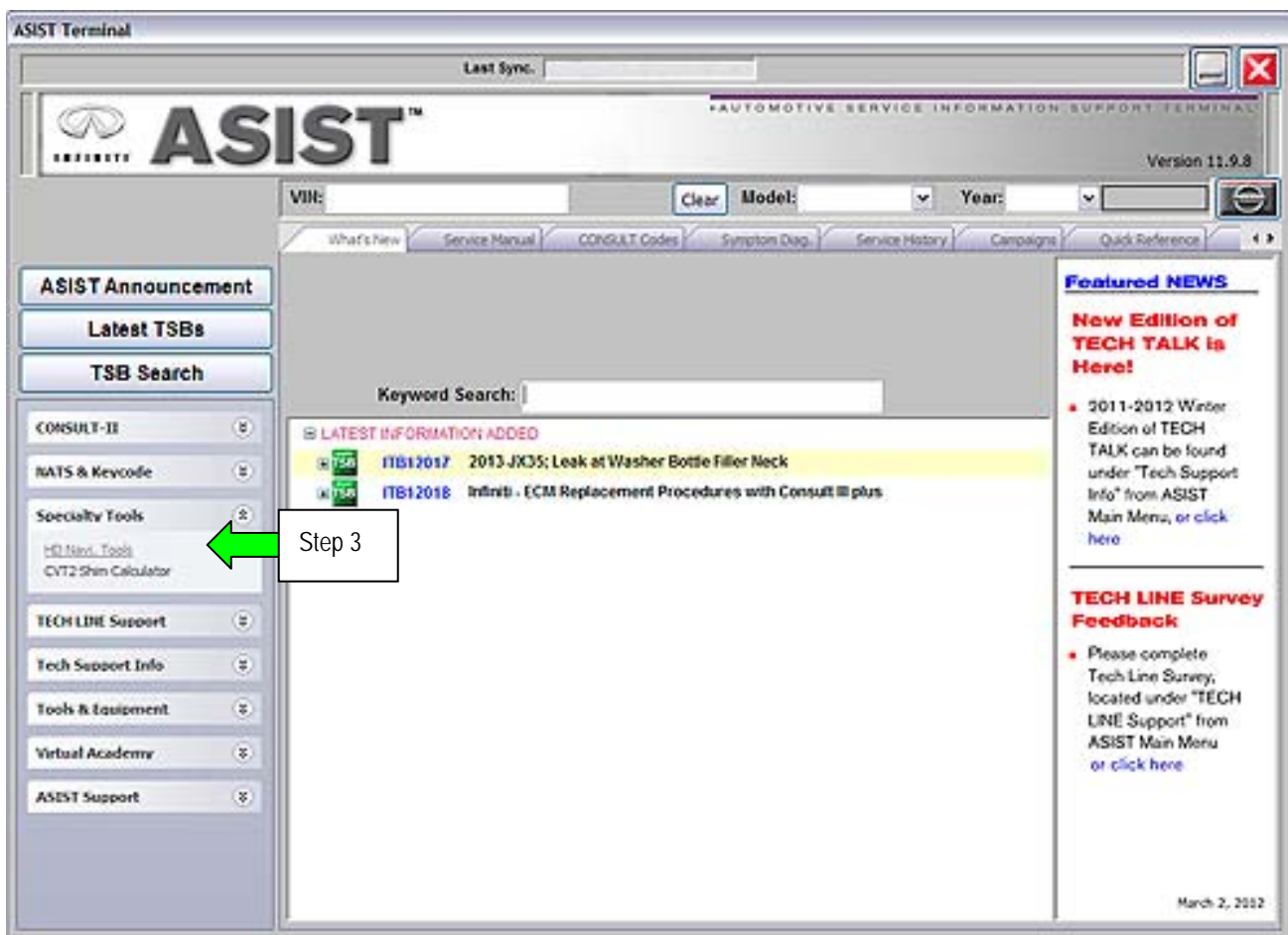

Figure 3-1

4. Select Install Map Update

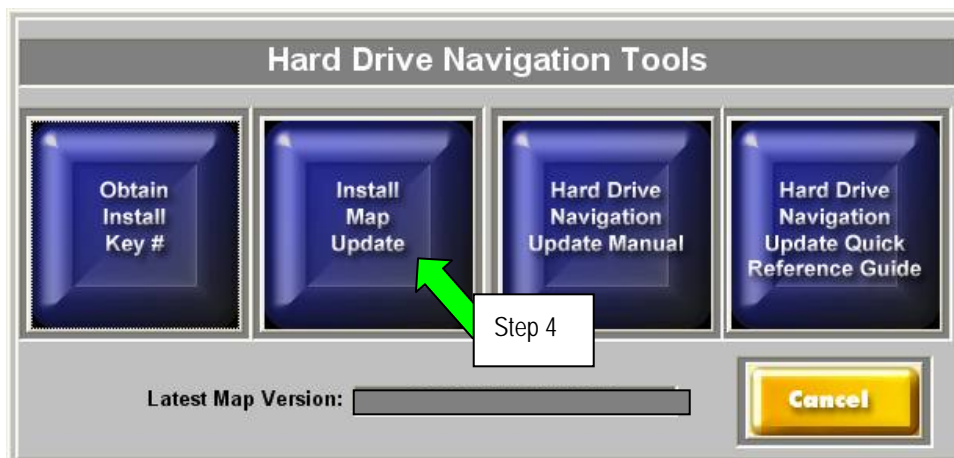

Figure 3-2

5. Select Generation and confirmation of Certification number.

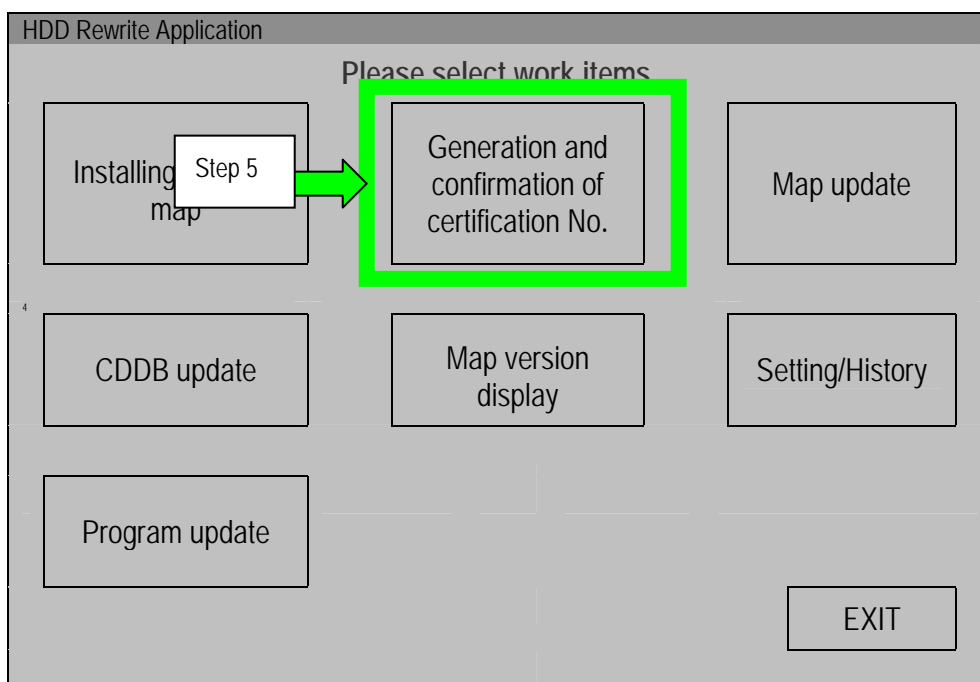

Figure 3-3

NOTE: If the HDD Rewrite application was open/running when you connected to the navigation system (plugged in the CF adapter), the navigation system may not be recognized and you may get an error message. In this case, exit/close ASIST, then start it again (reopen it).

6. Click **START**



Figure 3-4

NOTE: If you get the message shown in Figure 3-5:

- The map data installed in your Consult PC is the same or older than the map data in the vehicle. The map update may not be needed.
 - a. Skip to Section 6 on page 23 (disconnect the Consult PC from the vehicle navigation system).
 - b. Check the map version in the vehicle (see page 26).

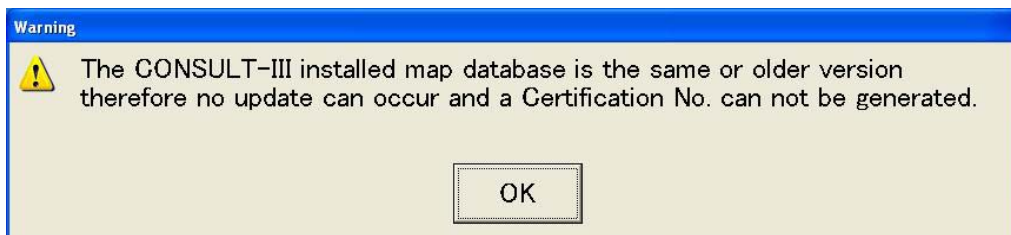

Figure 3-5

7. Write down the Certification Number.

8. Select **OK**

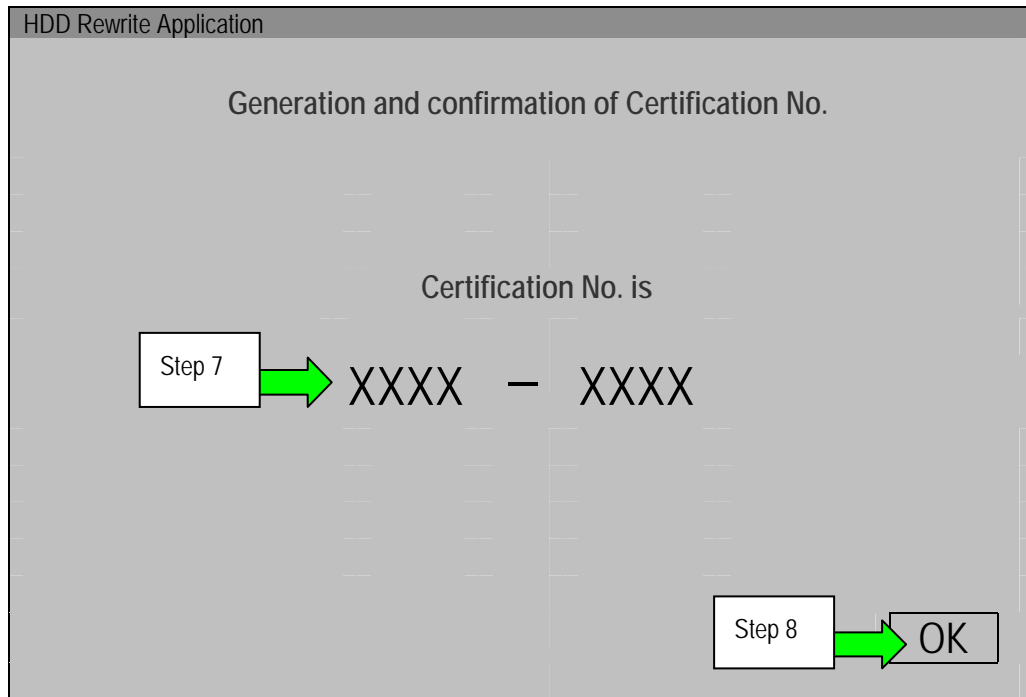

Figure 3-6

SECTION 4: ACQUIRING THE INSTALL KEY

- Before starting this section, you need:
 - A Coupon Number (purchased from NAVTEQ via the Internet at www.infinitinavigation.com or by calling NAVTEQ at 1-866-462-8837).
 - A Certification No. (Generated from the vehicle HDD navigation unit in Section 3).
- The Consult PC must be connected to the Internet for this Section.

NOTE: This section can be done using any PC containing ASIST or at any desktop computer. An Internet connection is required. Enter this Internet address: <http://www.nissan-mapupdate.com>

- Or if a smart phone is available that has a “QR scanner App” and Internet service, scan below.



Scan Here with QR
enabled smart phone to
access Figure 4-3

- To access the license server to acquire an Install Key (Install Code), your Internet browser must be set to accept cookies.
 - Once you have acquired the Install Key from the license server, cancellation and reissue of the Install Key is not allowed.
 - The acquired Install Key is valid for only three days from the date of issue.
 - You can retry the upgrade operation by using the same Install Key at any time during the three day period, but it cannot be used after the three day period has expired.
 - If you forgot the Install Key during the three day period, you can obtain the same Key by performing this section again. The key is still only valid for 3 days from the original date of issue.
1. If a Login screen is displayed after accessing the Nissan-mapupdate website, enter user ID “nissan” and password “nis06map”, then select **Login**.

2. Enter the following numbers correctly (see Figure 4-3):
 - Coupon No. (Coupon No. purchased from NAVTEQ)
 - Today's Date
 - Certification No. (number generated from vehicle HDD navigation unit in Section 3)

3. Select **CONTINUE**

NOTE:

- If you receive an error message "**Invalid Coupon Code**", please log on to another computer that is not a CONSULT PC and repeat steps 1 through 3.
- After obtaining the install Key, please return to the original Consult PC that generated the certification code.

The screenshot shows a web browser window with the Nissan and Infiniti logos at the top. The page title is "Obtain Install Key". Below the title, there is a message: "Please complete all fields and click "CONTINUE"(all fields required)".

Instructions:

- Please enter the Coupon No. provided by customer.
- Please enter the Certification No. acquired from the HDD Rewrite Application.
- Please note that the letter "O" is not used in any Coupon No. or Certification No.

Form fields:

Coupon No.	xxxx - xxxx	[This number can contain only A-Z, 0-9]
Today's Date	Mo. xx Day xx Yr. 20xx	[Enter only numbers for today's date]
Certification No.	xxxx - xxxx	[This number can contain only A-Z, 0-9]

Buttons: CLEAR, CONTINUE

A green arrow points to the CONTINUE button, with a box labeled "Step 3" next to it.

Footer: (C) Copyright NISSAN MOTOR CO., LTD. 2007 All rights reserved.

Figure 4-3

4. On the next screen (Confirmation of Install Key Request), confirm all the numbers you entered are correct. (See Figure 4-4).

5. Select **ISSUE**

Example only

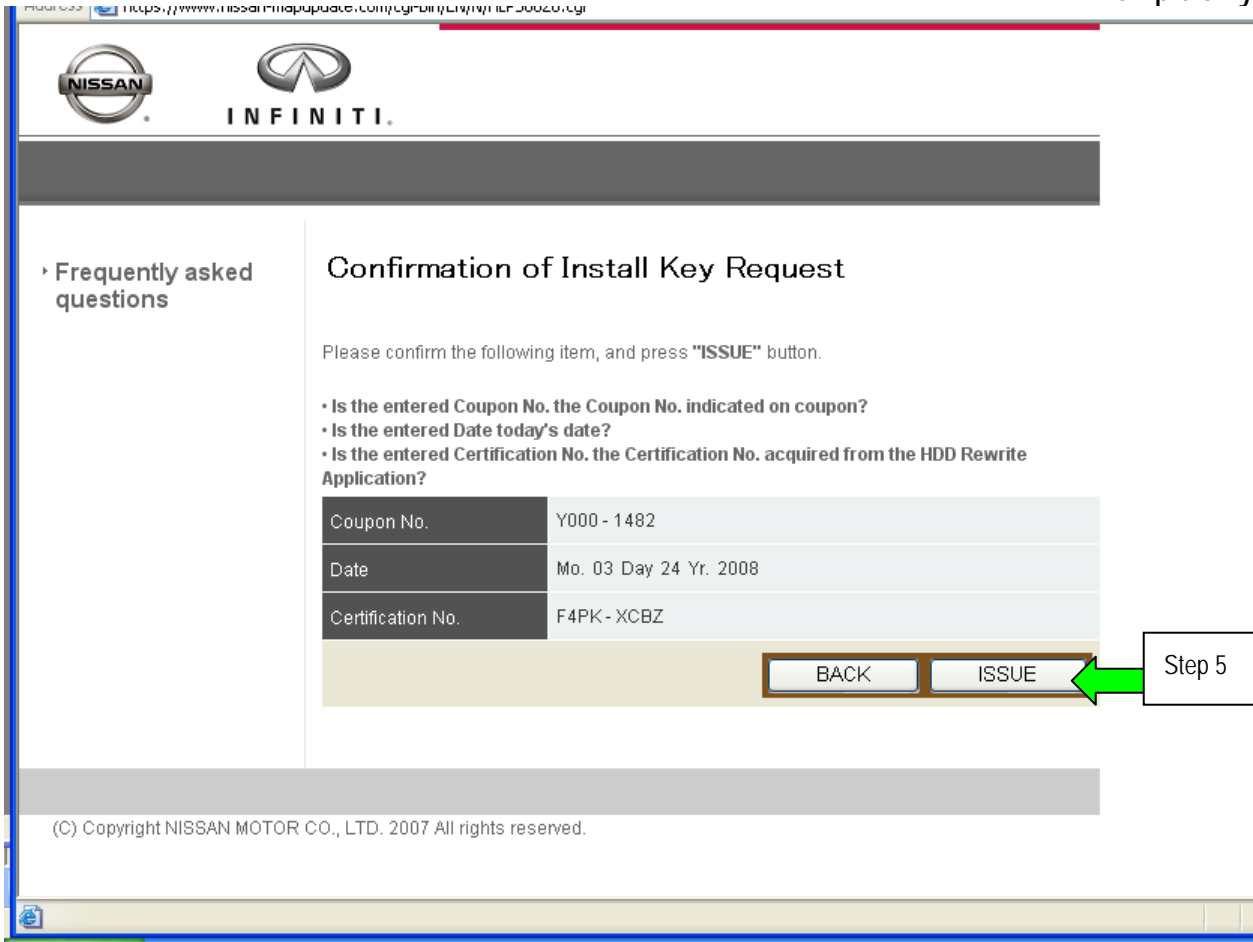

Figure 4-4

6. Select PRINT to print the screen, or write down the Install Key exactly.

7. After printing the screen or writing down the Install Key, select COMPLETED.

Example only

NISSAN INFINITI.

› Frequently asked questions

Result of Install Key Request

COMPLETED Step 7

Please press "PRINT" button, and print the screen.
Please press "COMPLETED" button when printed.

Install Key has an expiration date.
Install Key expires in 3 days.

Coupon No.	Y000 - 1482
Date	Mo. 03 Day 24 Yr. 2008
Certification No.	F4PK - XCBZ
Install Key	01C1 - XNT0 - VIRH

Install Key Step 6

PRINT

(C) Copyright NISSAN MOTOR CO., LTD. 2007 All rights reserved.

Done

Figure 4-5

8. Close the Internet window.

SECTION 5: UPGRADING THE MAP DATA IN THE HDD NAVIGATION SYSTEM

- Make sure to perform this operation on the same HDD navigation unit (vehicle) from which you generated the Certification Number.
- Upgrading the map data cannot be performed by using an Install Key that was acquired by using a Certification Number generated from a different HDD navigation system.
- Make sure to use the same the Consult PC that was used to generate the Certification Number.

1. Connect the Consult PC power cord (A.C. adapter or vehicle D.C. adapter).
 - Updating the map data will take a few minutes. Connecting the power cord will ensure the Consult PC maintains power during the update.
 - Vehicle ignition must remain OFF
2. Select **Specialty Tools**, Then **HD Navi. Tools**.

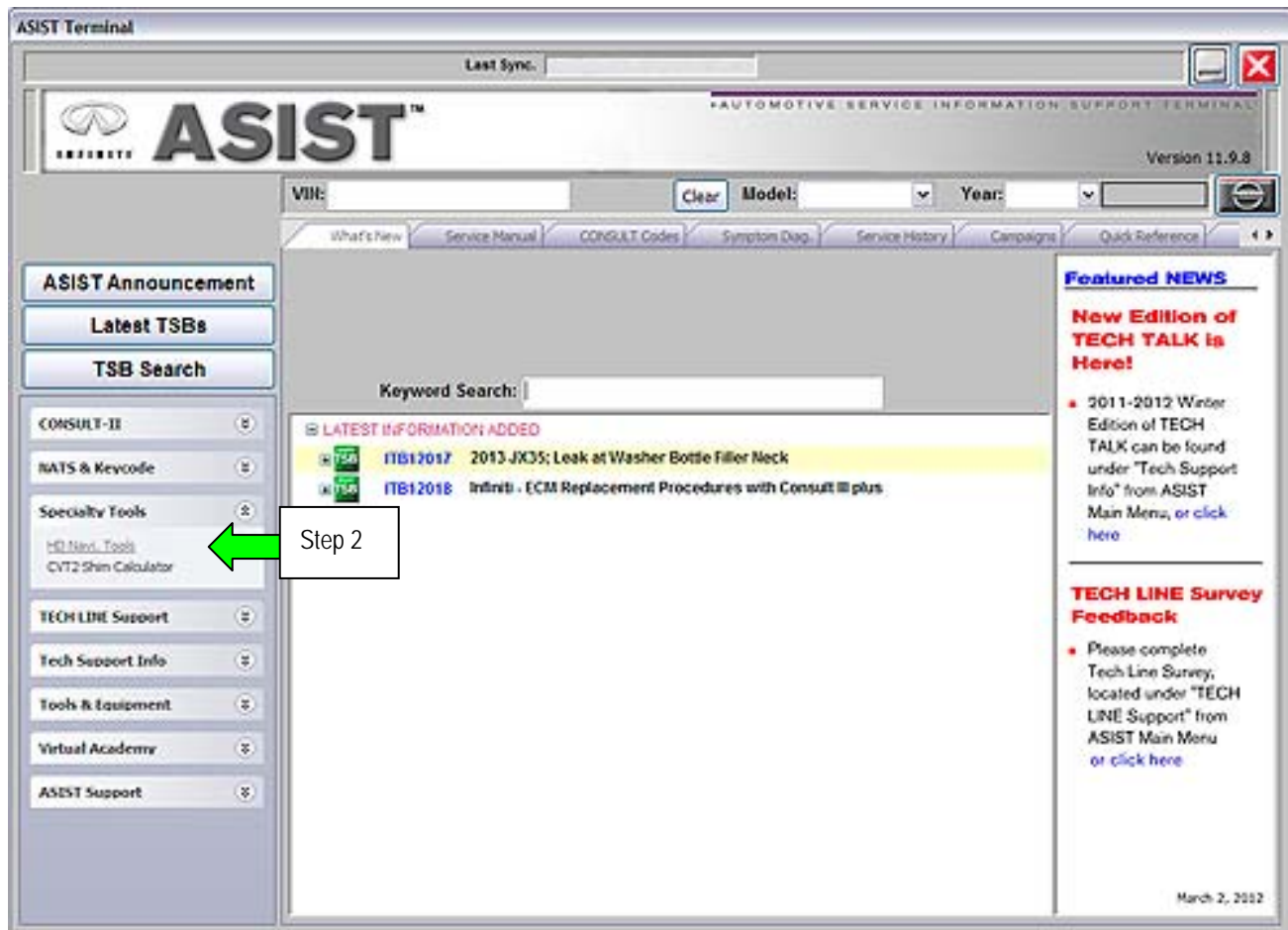

Figure 5-1

3. Select Install Map Update



Figure 5-2

4. Select Map update

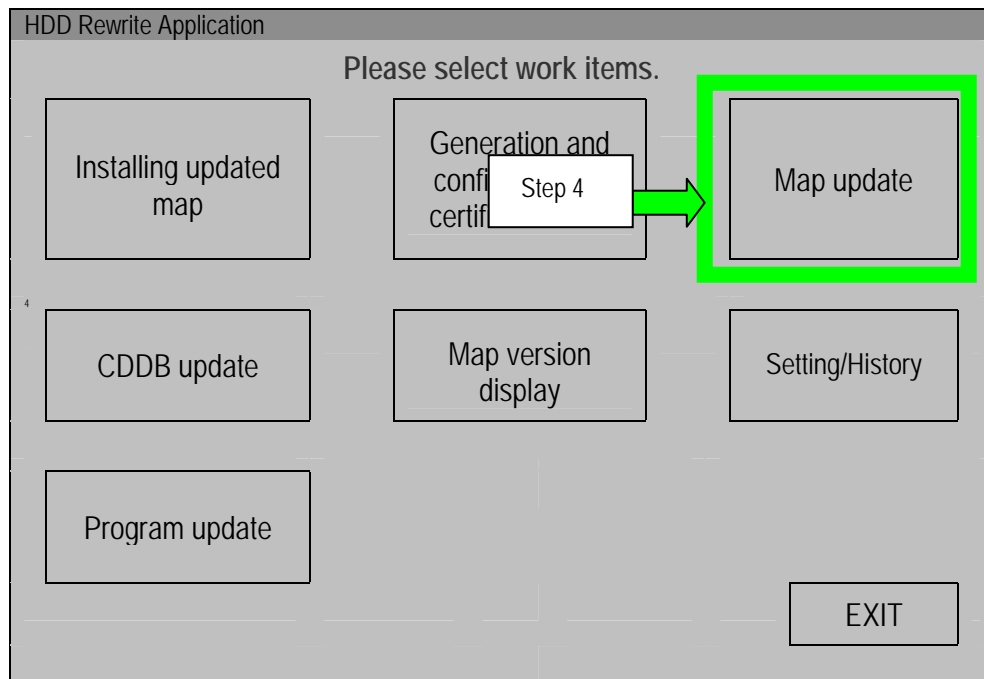

Figure 5-3

5. Select **NEXT**

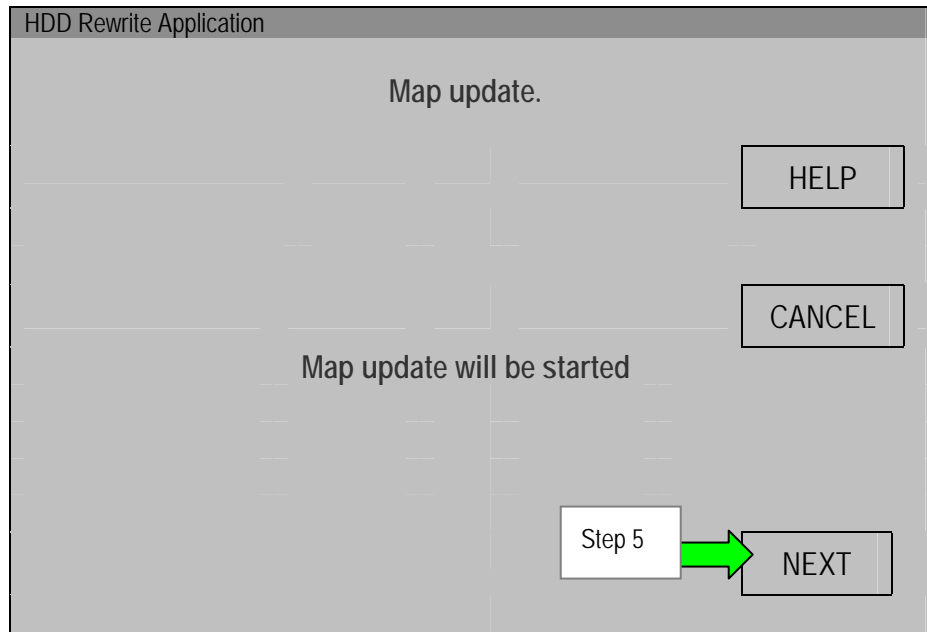

Figure 5-4

6. Carefully enter the Install Key.

7. Select **NEXT**

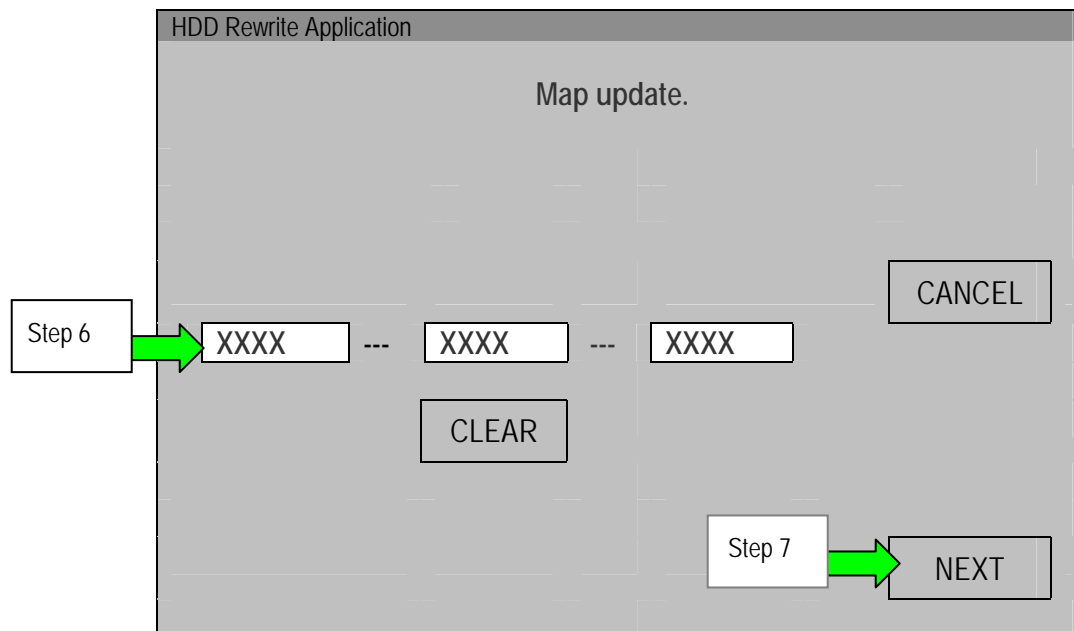

Figure 5-5

8. Confirm the version number of “New version of map data” is higher than “Current version of map data”.

9. Select **START**

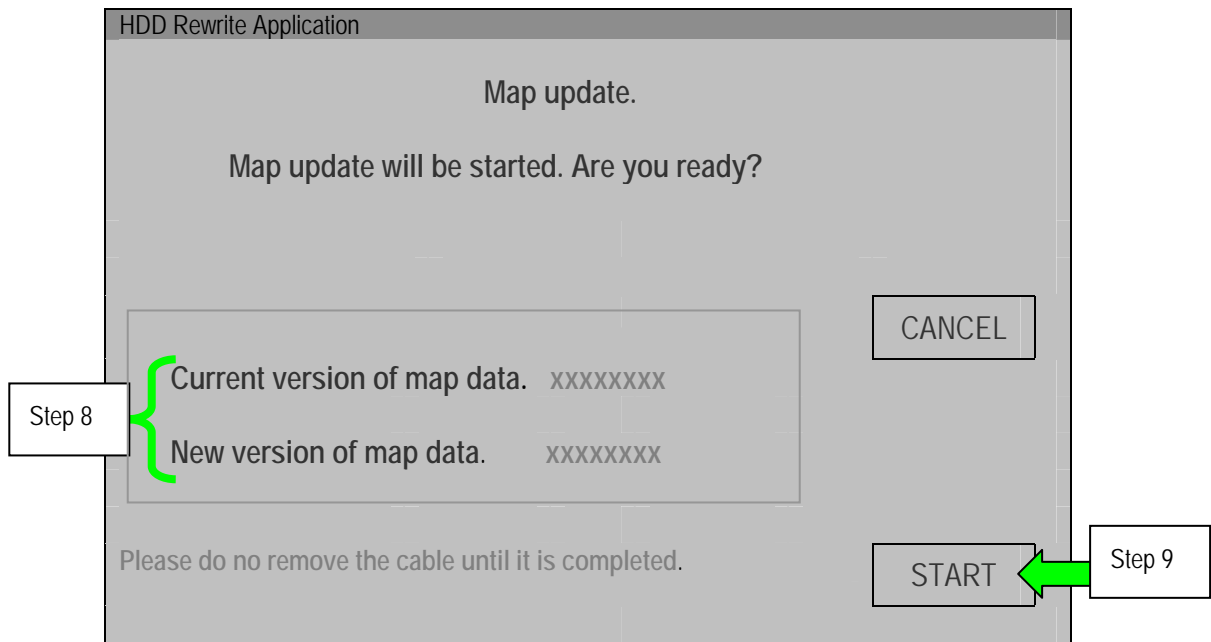

Figure 5-6

- Map update will begin and a progress bar will be displayed as shown in Figure 5-7.

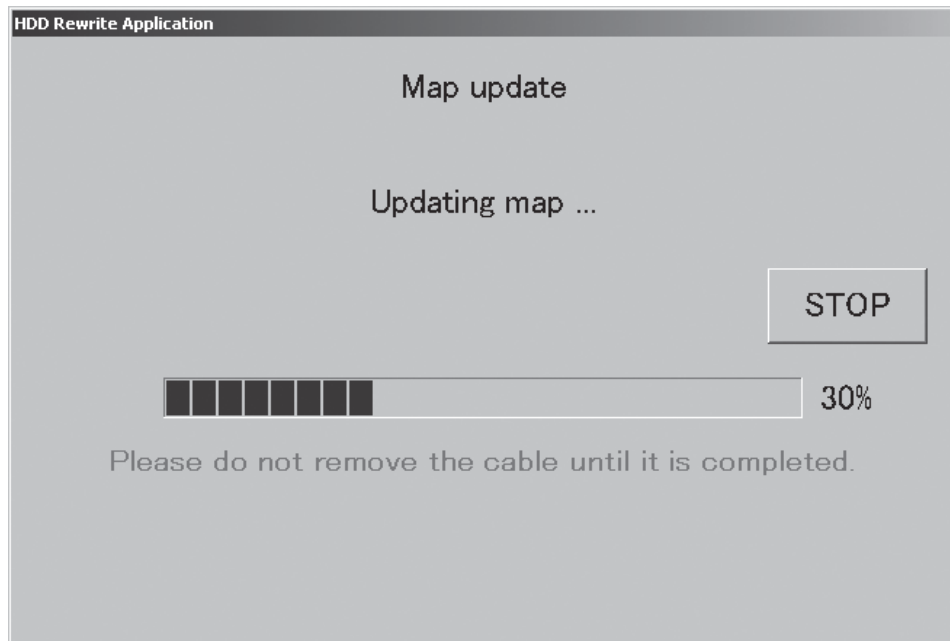

Figure 5-7

- When update is complete the screen in Figure 5-8 will display.

10. Select **OK**

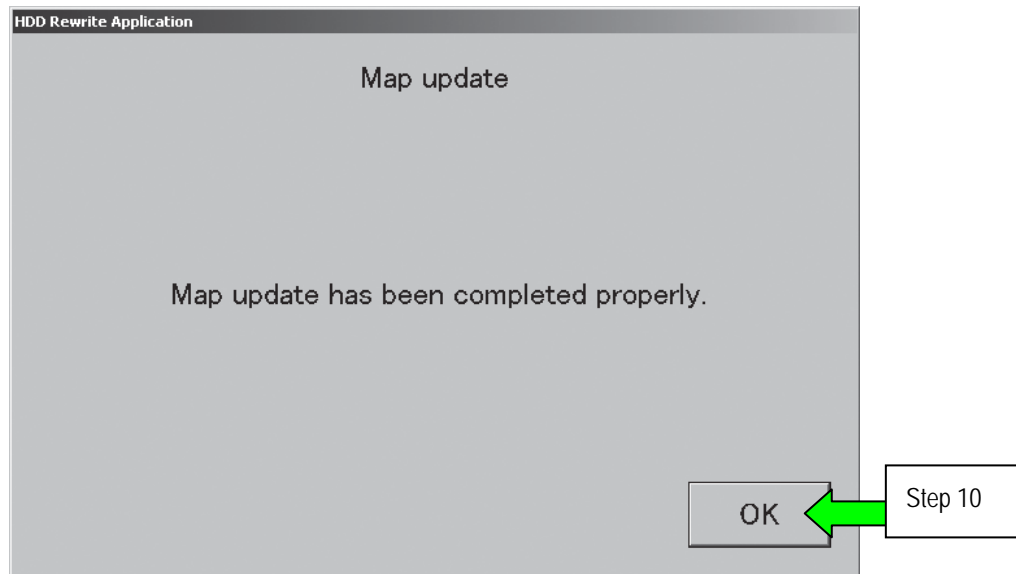

Figure 5-8

NOTE: If the update does not complete correctly, do the following:

- a. Perform Section 6: Disconnecting the Consult PC and CF Adaptor – on page 23.
- b. Make sure the vehicle battery is sufficiently charged.
- c. Perform Section 2 again: Connecting the Consult PC to the HDD Navigation System on page 9.
- d. Perform Section 5 again: Upgrading the Map Data in the HDD Navigation System – on page 18.

SECTION 6: DISCONNECTING the Consult PC and CF (Compact Flash) ADAPTER.

NOTE: Do not touch the CF (Compact Flash) adapter with wet hands.

1. Select **EXIT**

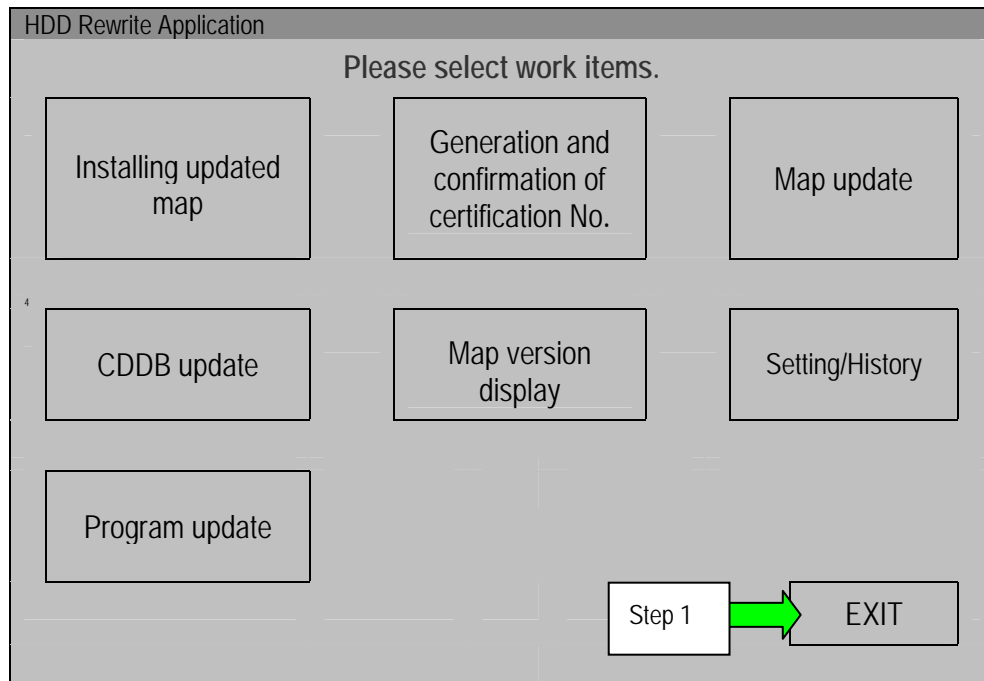

Figure 6-1

2. Select the **Safely Remove Hardware** icon on the "system tray" which is displayed in the bottom right of the Consult PC computer screen.
 - You may need to click on the "expand arrow" to expand the icon selections.

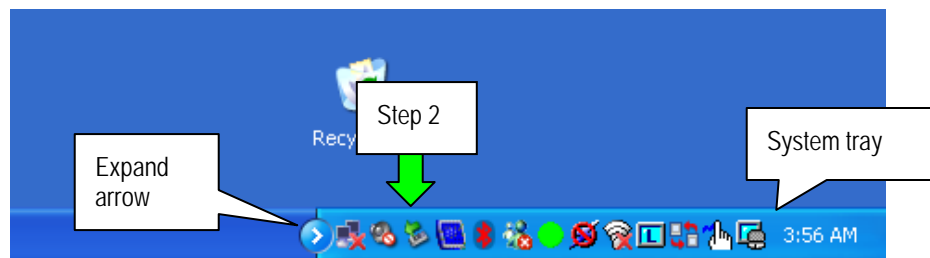

Figure 6-2

3. Select **Safely remove USB Mass Storage Device**

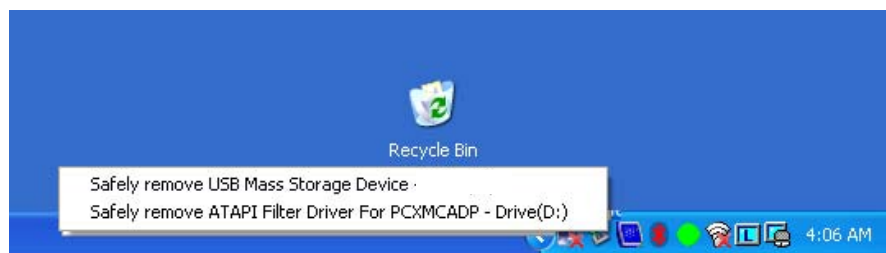

Figure 6-3

4. After the message "Safe to Remove Hardware" is displayed, disconnect the USB cable from the Consult PC.

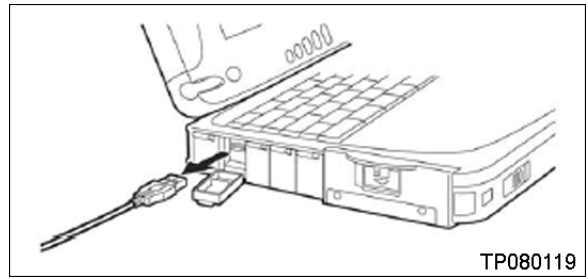

Figure 6-4

5. Push the Eject button at the right of the CF card slot and carefully remove the CF adapter.

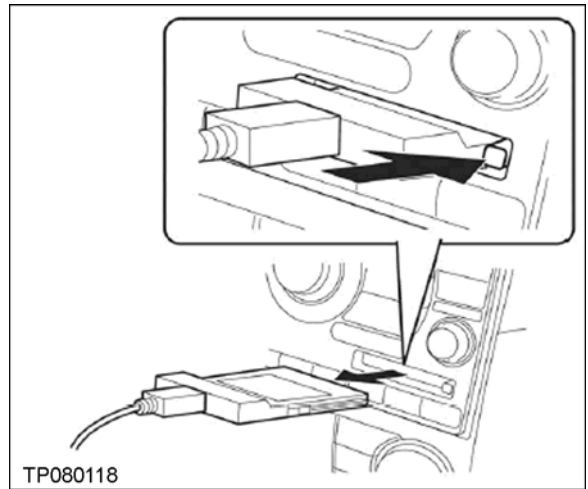

Figure 6-5

NOTE: When not in use, store the CF adapter in its original plastic bag.

SECTION 7: VERIFYING THE UPGRADE RESULT

- When the map data upgrade operation is complete, confirm that the HDD navigation system is operating correctly.
- **Make sure the CF adapter is disconnected from the navigation system before performing the following steps.**

1. Turn the ignition ON.

- If the ignition is already ON, turn it OFF and then back ON.

2. The Program Loading screen as shown in Figure 7-1 will display.

- This process may take only a few seconds to complete or it may take a few minutes.

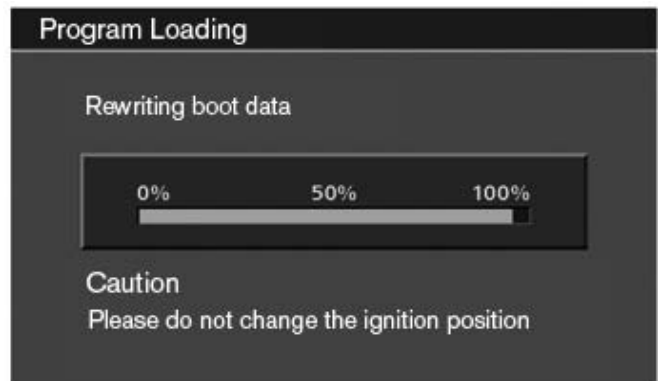

Figure 7-1

3. Select **MAP**, then **ENTER**.

- Make sure the navigation map displays and the system functions correctly.

NOTE: You can confirm the new map version in the vehicle using the navigation screen; see next page.



Figure 7-2

- If the fail-safe screen is displayed as shown in Figure 7-3, the map data upgrade failed.

Turn the ignition OFF; return to the beginning of the Service Procedure and follow all steps again exactly as written.

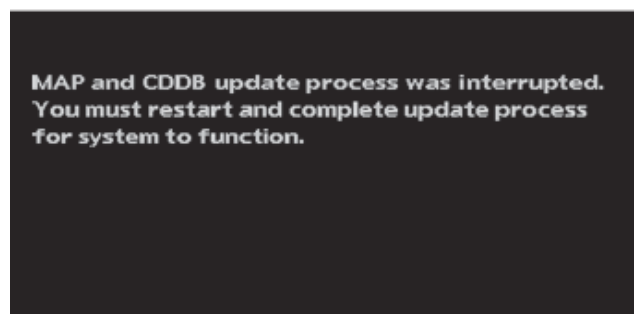

Figure 7-3

Checking Current Map Version in the Vehicle Using the Vehicle's Navigation Screen

- Make sure the CF (Compact Flash) adapter is disconnected from the navigation system before performing the following steps.

1. Turn the Ignition to ON or ACC, and turn ON the navigation system.

2. Select **INFO**



Figure 8-1

3. Use the arrows and enter buttons on the Multifunction Controller to select **Navigation Version**.



Figure 8-2

- The navigation / map version displays as shown in Figure 8-3.



Figure 8-3

HDD update kit (P/N: J-48850-A)

Kit Contents

- A. 08–09 Map Data Master Discs (2 disc set)
- All Map Data Master Discs in this kit and in the kit shipped in 2008 are obsolete, and are superseded by 2013MY (12-13) discs (available separately).

- B. CF (Compact Flash) Adapter

- C. USB cable

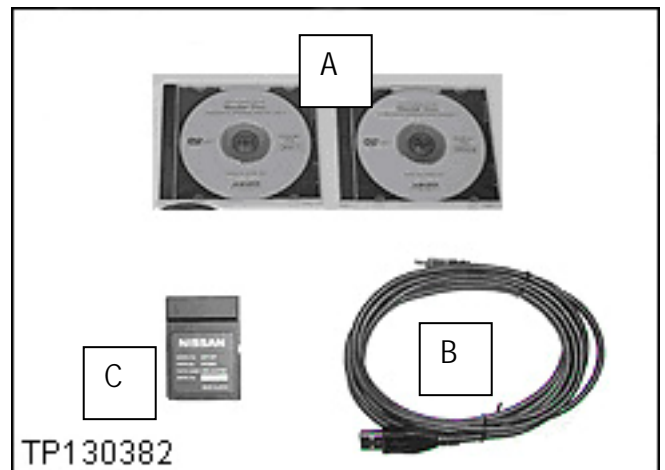

NOTE:

- New kits can be purchased from TECH-MATE at 1-800-662-2001.
 - 08–09 Map Data Master Discs (2 disc set) that are in this kit, and in the kit shipped in 2008, are now obsolete and have been superseded by the 2013MY (12-13) Upgrade Master Discs which are available separately.
-