



This Service Information bulletin supersedes SI M17 07 12 **dated October 2012.**

PERFORM THE PROCEDURE OUTLINED IN THIS SERVICE INFORMATION ON ALL AFFECTED VEHICLES BEFORE CUSTOMER DELIVERY OR THE NEXT TIME THEY ARE IN THE SHOP FOR MAINTENANCE OR REPAIRS.

NEW designates changes to this revision

SUBJECT

Service Action: Retrofit of the Engine Coolant Temperature Sensor

MODEL

R55

R56

R57

R58

All with manual transmission and either the N14, N16 or N18 engine

SITUATION

Internal corrosion could form in the engine coolant temperature sensor. This corrosion leads to internal bridging of the contacts, which can cause an inaccurate engine temperature reading. This false reading could lead to difficulty in the engine starting and/or a "Service Engine Soon" lamp being illuminated.

AFFECTED VEHICLES

This Service Action involves R55, R56, R57 and R58 MINI Cooper/Cooper S vehicles with the N14, N16 or N18 engines which were produced from 8/2010 to 3/2012.

In order to determine whether a specific vehicle has had this Service Action completed or is affected by this Service Action, first check the B-pillar label for code **53**. If code number **53** has been punched out, the campaign has already been performed. If code number **53** has not been punched out, it will be necessary to utilize the "Service Menu" of DCSnet (Dealer Communication System) or the Key Reader. Based on the response of the system, either proceed with the corrective action or take no further action.

PROCEDURE

NEW There are two approved repair procedures, depending on parts availability. Both procedures involve installing an engine temperature sensor remotely and wiring this new sensor into the vehicle's engine harness. Only perform one of these recommended procedures when completing this Service Action.

NEW **Procedure One** requires the replacement of the upper coolant hose with a modified hose that houses a new engine temperature sensor. An adapter harness needs to be fitted to the car to utilize this new sensor.

NEW or

Procedure Two requires the installation of a new engine temperature sensor, with integrated wire harness, installed in place of the thermostat bleeder screw.

NEW Note: This Service Action does not apply to any N16 engine that had a thermostat replaced with P/N 11 53 7 534 521. Vehicles equipped with the N16 engine may have had repairs performed prior to this Service Action, so installing this remote sensor and hose or the sensor in place of the bleeder screw is no longer required.

NEW The 11 53 7 534 521 thermostat would need to be installed in conjunction with an engine electrical wiring harness replacement. This thermostat already has an updated, replaceable engine coolant temperature sensor.

If the vehicle is in the workshop for this Service Action **and also** requires an engine wiring harness replacement:

- Replace the engine wiring harness with the 11 53 7 534 521 thermostat.
- Do not install the remote engine temperature sensor. Claim the labor operation “Check for 11 53 7 534 521 thermostat installation” in the Warranty Information section of this bulletin.
- Affix the Service Action label to the B-pillar.

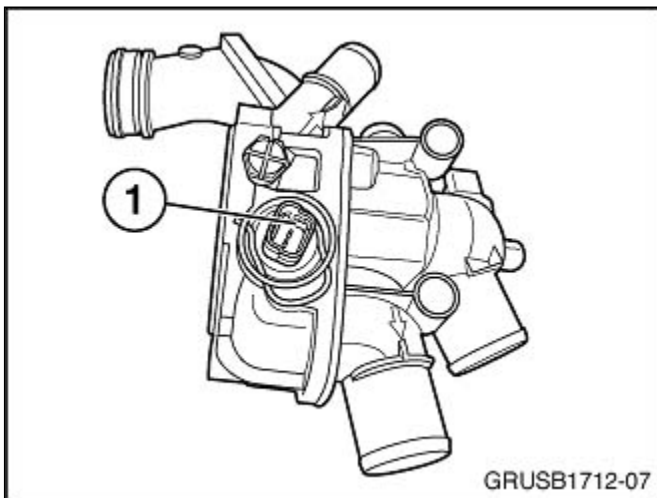

Checking for updated thermostat: The 11 53 7 534 521 thermostat has a replaceable engine temperature sensor (1).

NEW PROCEDURE ONE

Remove the fresh air intake tube and the intake tube from the air box to the turbo to gain access to the coolant hose.

Remove the coolant hose (1). This hose will not be reused.

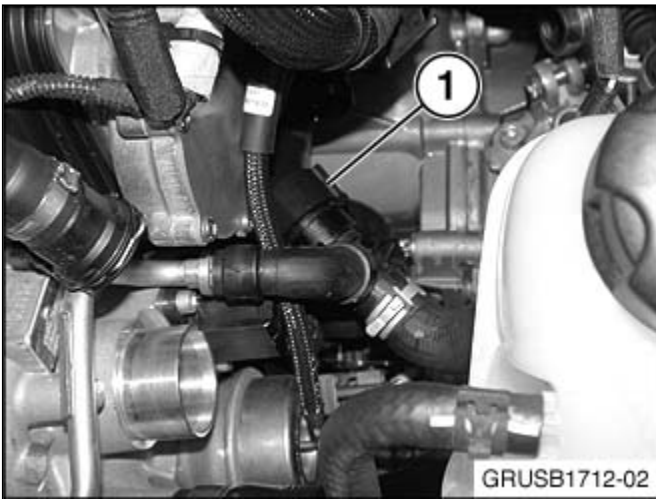
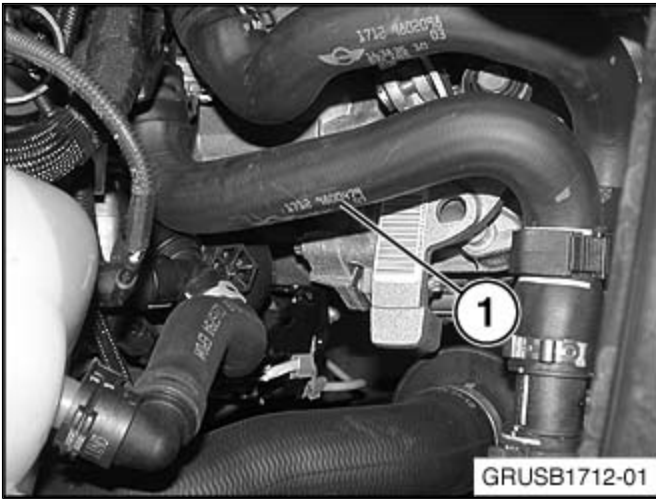

N18 engine only! Install spacer P/N 64 53 7 578 707 (1) on the coolant line as shown.

Note: The spacer needs to stay in this position when installing the new coolant hose P/N 17 12 7 647 004 (next step).

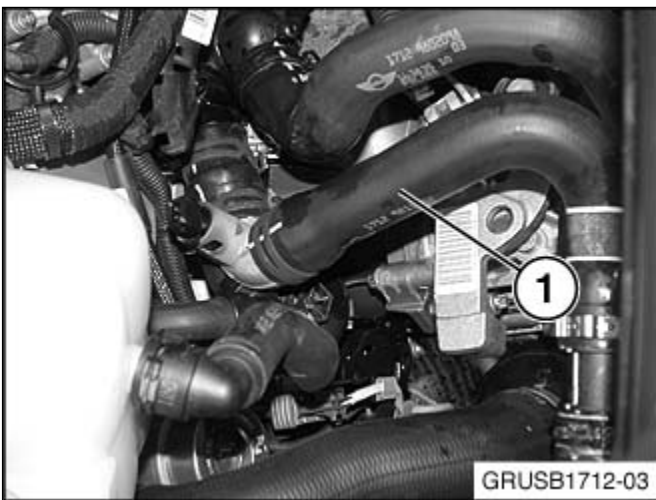

Install the new coolant hose with sensor P/N 17 12 7 647 004 (1).



Unplug connector X6279 from the engine thermostat (1).

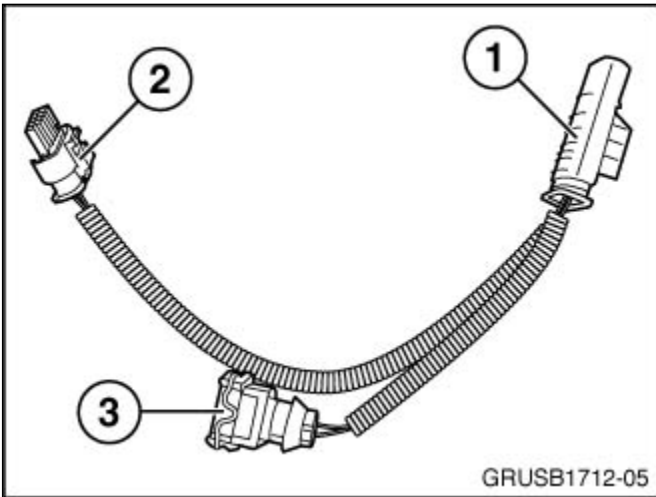

Plug connector X6279 into the 4-pin male connector (1) of adapter harness P/N 12 51 7 647 200. Insert the 4-pin female connector (2) of the adapter harness into the engine thermostat. Plug the 2-pin female connector (3) from the adapter harness into the engine temperature sensor of hose P/N 17 12 7 647 004.



Secure the connector (1) with a cable tie to the engine wiring harness.

Reinstall the intake components and vent/refill the cooling system (Repair Instruction 17 00 039).

NEW PROCEDURE TWO

Remove the fresh air intake tube and the charge air intake tube from the air box to the turbo to gain access to the engine harness at the thermostat.

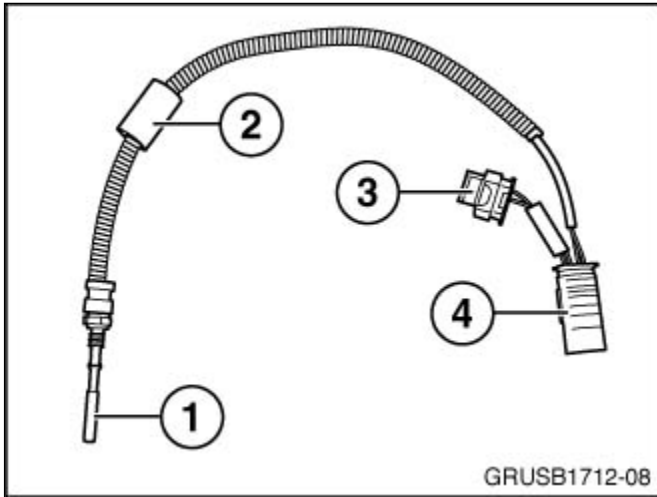

The improved sensor (P/N 13 62 8 603 908) includes the temperature probe (1) and insulating sleeve (2), a two-pin female connector (3) for the map thermostat, and a four-pin connector (4) for the engine harness.

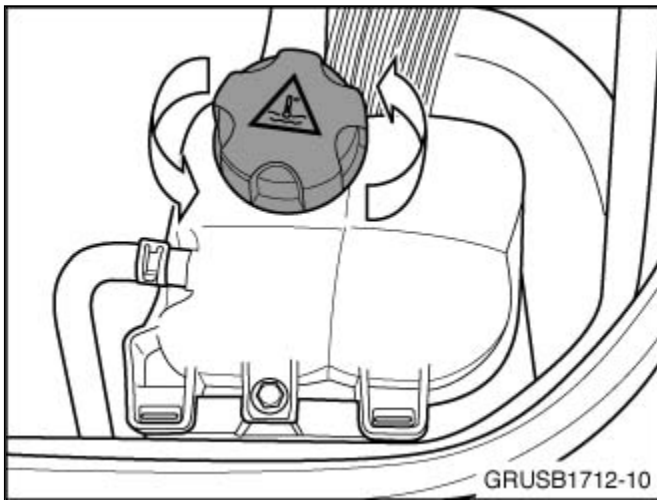

Relieve the coolant pressure by removing the reservoir cap, and then re-tighten.

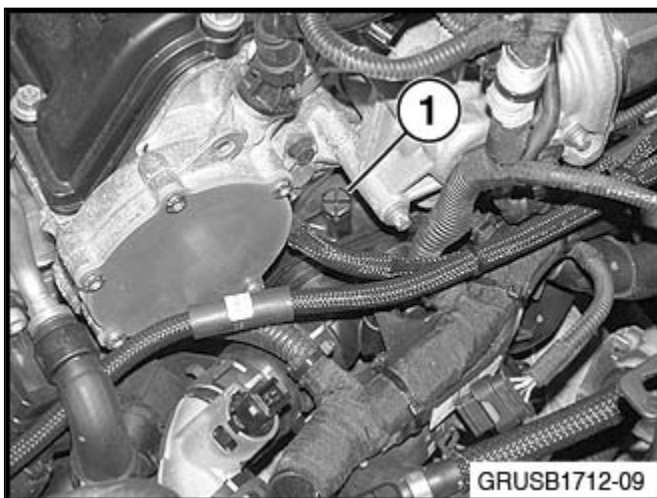

Remove the bleeder screw (1) from the thermostat. This screw will not be reused.

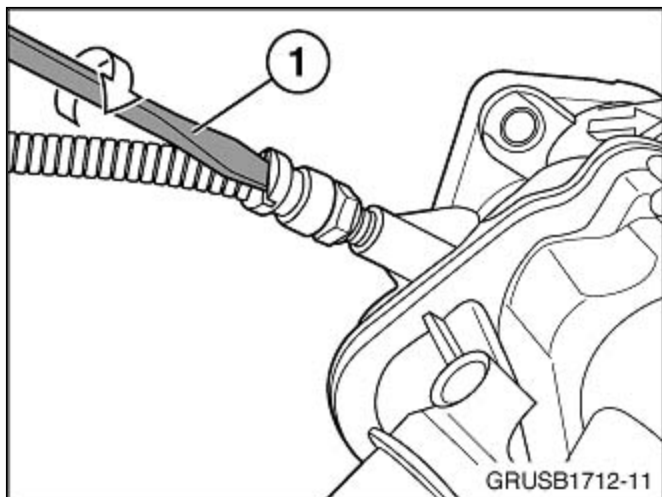

The back of the temperature sensor is slotted to accept a bladed screwdriver (1). Install the sensor into the bleeder screw hole, and torque to 2Nm.

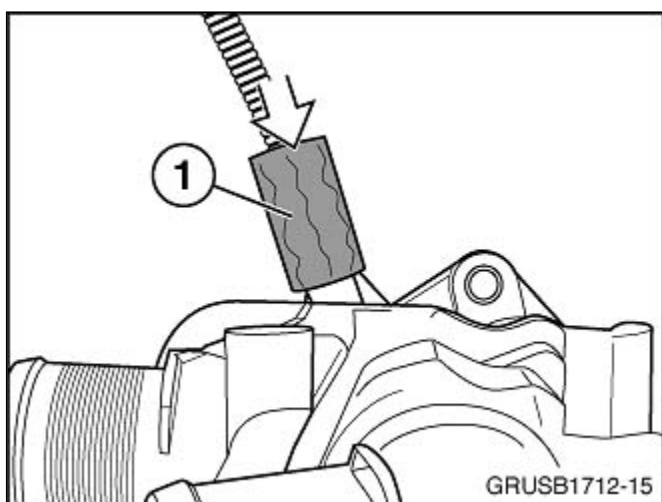

Slide insulating sleeve (1) onto the temperature sensor. The sleeve must completely cover the sensor.

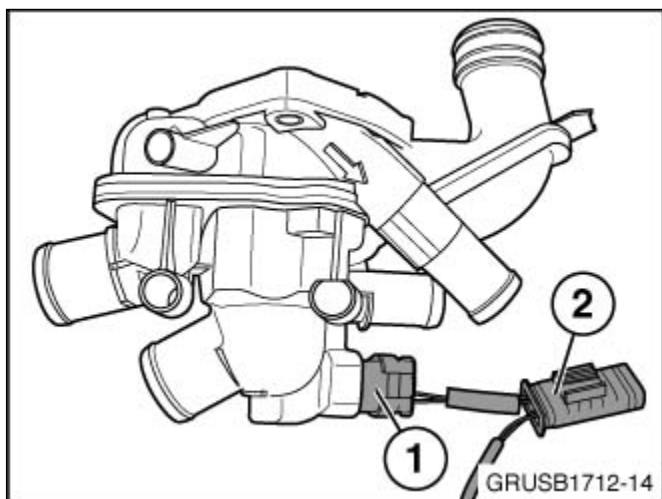

Install the two-pin female connector (1) into the thermostat and the four-pin male connector (2) into the engine wiring harness

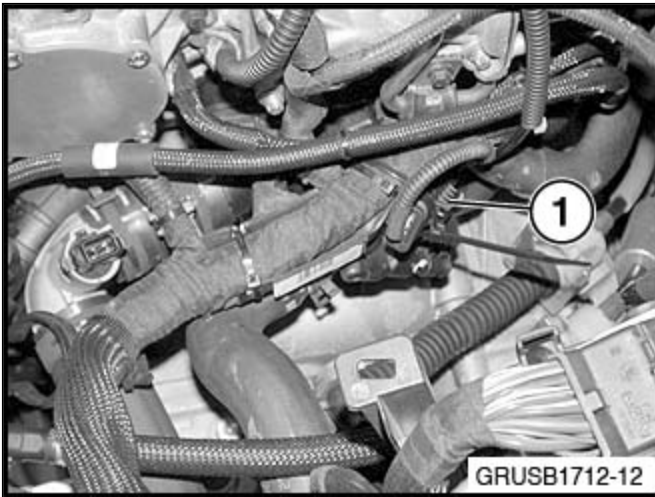

Secure the connector (1) with a cable tie to the engine wiring harness.

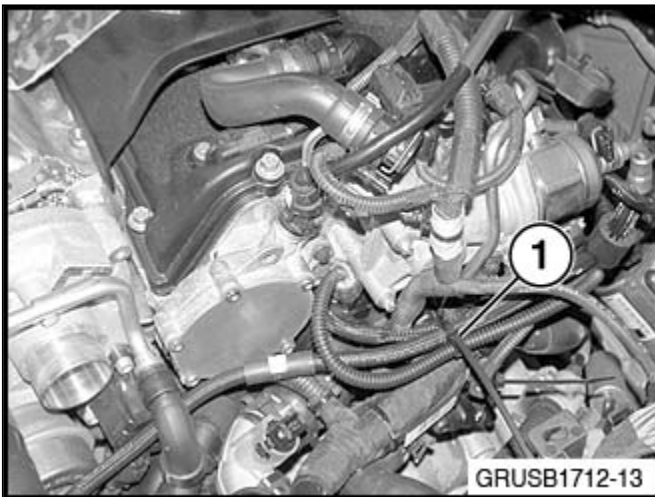

Secure the wiring from the temperature sensor (1) with a cable tie.

Reinstall the intake components and vent/refill the cooling system (Repair Instruction 17 00 039).

Note: This repair procedure involves draining a small quantity of coolant; refill the drained quantity with new MINI Long-term Antifreeze/Coolant (50/50 mixture). Do not reuse the drained coolant.

NEW PARTS INFORMATION

Procedure One

Part Number	Description	Quantity
12 51 7 647 200	Adapter cable	1
64 53 7 578 707	Spacer (N18 only)	1
17 12 7 647 004	Coolant hose	1
61 13 1 367 599	Cable tie	1

or

Procedure Two

Part Number	Description	Quantity
13 62 8 603 908	Temperature sensor	1
61 13 8 383 722	Cable tie	2

LABEL INSTRUCTIONS

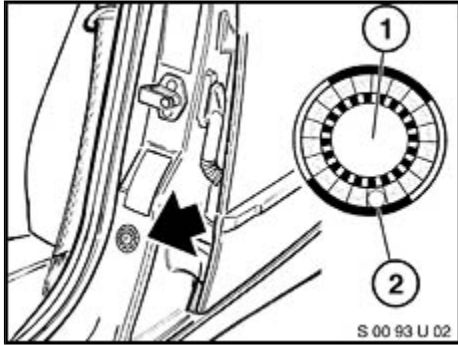

This Service Action has been assigned code number **53**. After the vehicle has been checked and/or corrected, obtain a label (MD20-040) and:

- A. Emboss your MINI dealerr warranty number in the middle of the label (1);
- B. Punch out code number **53** (2), printed on the label; and
- C. Affix the label to the B-pillar as shown.

If the vehicle already has a label from a previous Service Action/Recall Campaign, affix the new label next to the old one. Do not affix one label on top of another one because a number from an underlying label could appear in the punched-out hole of the new label.

NEW WARRANTY INFORMATION

The repair described in this bulletin is covered under warranty regardless of time or mileage.

Reimbursement for this Service Action will be via normal claim entry utilizing the following information.

Defect Code: **00 17 54 01 00**

Procedure One

Labor Operation:	Labor Allowance:	Description:
00 61 518	Refer to KDS2	Check for the 11 53 7 534 521 thermostat installation; no repair is necessary.
or		
00 60 933	Refer to KSD2	Replace the coolant line (hose) and connect the adapter cable.
Sublet Code 4	See sublet reimbursement calculation below	Reimbursement for replacing the drained quantity of antifreeze/coolant (bulk container reference P/N 82 14 0 031 133, one gallon container. Do not use this part number for claim submission).

or

Procedure Two

Labor Operation:	Labor Allowance:	Description:
00 61 561	4 FRU	Install coolant temperature sensor
and		
Sublet Code 4	See sublet reimbursement calculation below	Reimbursement for replacing the drained quantity of antifreeze/coolant (bulk container reference P/N 82 14 0 031 133, one gallon container. Do not use this part number for claim submission).

Labor operation codes 00 61 518, 00 60 933 and 00 61 561 are Plus labor operations.

Refer to KSD2 for the corresponding flat rate unit (FRU) allowance. Enter the Chassis Number, which consists of the last 7 digits of the Vehicle Identification Number (VIN). Click on the “Search” button, and then enter the applicable flat rate labor operation in the FR code field.

Sublet calculation: MINI antifreeze/coolant (bulk container reference P/N 82 14 0 031 133 only) — partial refill/used quantity (50/50 mixture) at dealer net plus handling. Enter this material cost in sublet and itemize the amount in the claim comment section.

[MINI, a division of BMW of North America, LLC
Copyright © 2013 BMW of North America, LLC]