

Safety Connect Volume Improvement

Service Category Audio/Visual/Telematics

Section Audio/Video

Market USA

Toyota Supports
 ASE Certification 

Applicability

YEAR(S)	MODEL(S)	ADDITIONAL INFORMATION
2012	Prius PHV	
2012	Prius	

REVISION NOTICE

April 11, 2013 Rev1:

- The Introduction has been updated.
- Figures with connector L142 have been updated.

Any previous printed versions of this bulletin should be discarded.

Introduction

Some 2012 model year Prius and Prius PHV vehicles may exhibit a lower-than-expected speaker volume on the Safety Connect system, which may make the audio prompts difficult to understand. An updated wire harness is available to address this condition.

Production Change Information

This bulletin applies to vehicles produced **BEFORE** the Production Change Effective VINs shown below.

MODEL	DRIVETRAIN	PLANT	PRODUCTION CHANGE EFFECTIVE VIN
Prius	FWD	Tsutsumi	JTDKN3DU#C1532789
Prius PHV			JTDKN3DP#C3008727

Warranty Information

OP CODE	DESCRIPTION	TIME	OFP	T1	T2
EL1223	Install Telephone Wire Harness	1.9	82145-47Y20	76	99

Safety Connect Volume Improvement

Warranty Information (Continued)

APPLICABLE WARRANTY

- This repair is covered under the Toyota Basic Warranty. This warranty is in effect for 36 months or 36,000 miles, whichever occurs first, from the vehicle's in-service date.
- Warranty application is limited to occurrence of the specified condition described in this bulletin.

Parts Information

PREVIOUS PART NUMBER	CURRENT PART NUMBER	PART NAME	QTY
N/A	86712-47070	Telephone, Wire*	1
82999-52010	Same	Sleeve	4
82999-30010	Same	Thermo Contact Tube	4

* Referred to as "new sub-wire harness" in this bulletin.

Required Tools & Equipment

SPECIAL SERVICE TOOLS (SST)	PART NUMBER	QTY
Plastic Pry Tool Set*	00002-06000-01	1
Wire Crimper (Non Insulated)*	09042-2C100	1

REQUIRED MATERIAL	QUANTITY
Marker Pen OR Correction Fluid (White or Silver Color)	1

* Essential SST.

NOTE

Additional SSTs may be ordered by calling 1-800-933-8335.

Safety Connect Volume Improvement

Procedure Overview

- **Section 1: Diagnostic Procedure**

This procedure will determine the correct repair method.

- **Section 2: Wire Harness Repair Procedure**

This section will provide the detailed steps to install the new sub-wire harness.

- **Section 3: Verify Repair**

This procedure will verify audio performance of the Safety Connect Function and the audio system.

- **Section 4: Electrical Wiring Diagram**

Use this diagram to verify the new sub-wire harness installation.

Section 1: Diagnostic Procedure

1. Place vehicle in "IG-ON" mode. Wait about 15 seconds.

NOTE

Do NOT press brake pedal. Press Power switch twice.

2. Press the SOS button located on the overhead map light assembly. Then within 10 seconds, press the SOS button a second time (to cancel SOS call placement).

NOTE

The Safety Connect system when functioning with a valid account will facilitate audio communication with an emergency call center agent. The purpose of pressing the SOS button a second time is to terminate the call so that an emergency is not presumed by the Safety Connect call center.

3. Is there an audio prompt heard?

- **YES** — Continue to step 4.
- **NO** — STOP. Diagnose for inoperative Safety Connect function per the Repair Manual.

4. Was the audio prompt loud and clear?

- **YES** — STOP. This bulletin does NOT apply.
- **NO** — Proceed to the Wire Harness Repair Procedure in this bulletin.

5. Shut off car.

Safety Connect Volume Improvement

Wire Harness Repair Procedure

1. Remove the negative (-) terminal from the battery.
2. Remove the integration control and panel assembly.
 - A. Using a plastic pry tool, slightly lift the panel at the position shown in the illustration.
 - B. Pull the integration control and panel assembly in the direction indicated by the arrow to disengage the 6 claws.
 - C. Disconnect each connector and remove the integration control and panel assembly.

Figure 1.

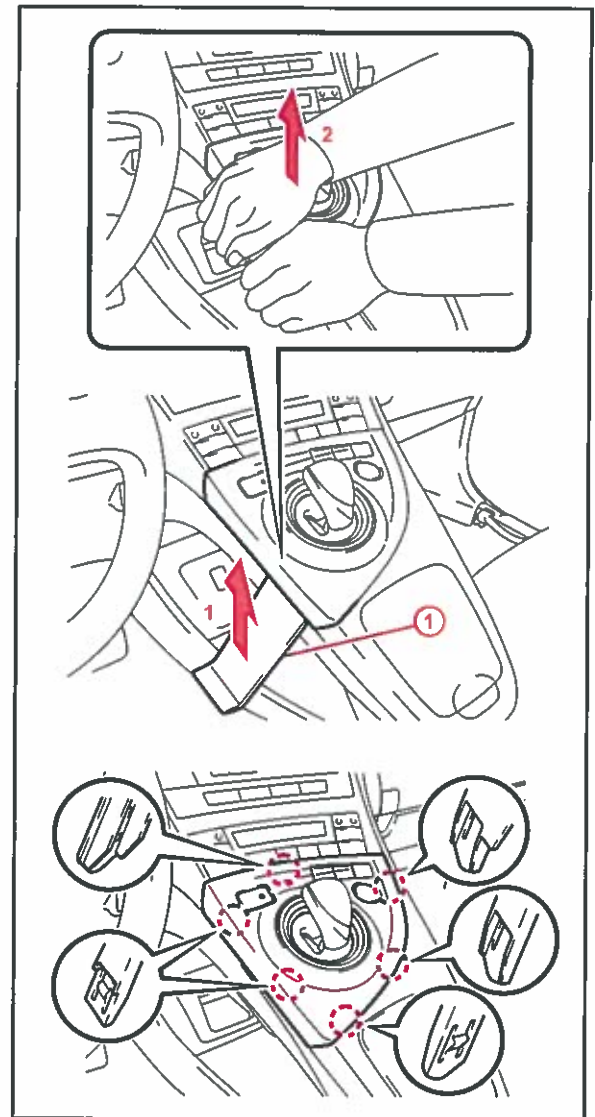

1 Lift Panel

Safety Connect Volume Improvement

Wire Harness Repair Procedure (Continued)

3. Remove the lower center instrument cluster finish panel sub-assembly.

- A. Pull the lower center instrument cluster finish panel sub-assembly in the direction indicated by the arrow to disengage the 2 claws and 2 clips.

Figure 2.

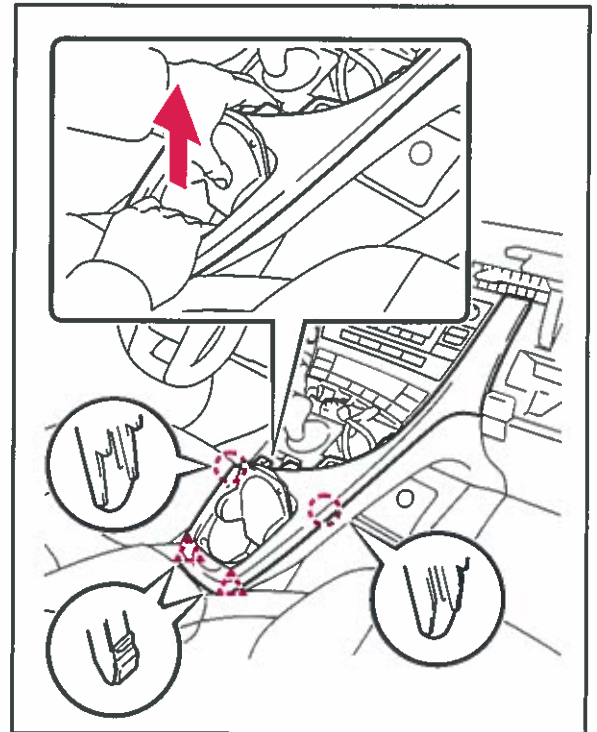

Safety Connect Volume Improvement

Wire Harness Repair Procedure (Continued)

- B. Pull the lower center instrument cluster finish panel sub-assembly in the direction indicated by the arrow to disengage the 5 claws and remove the lower center instrument cluster finish panel sub-assembly.

Figure 3.

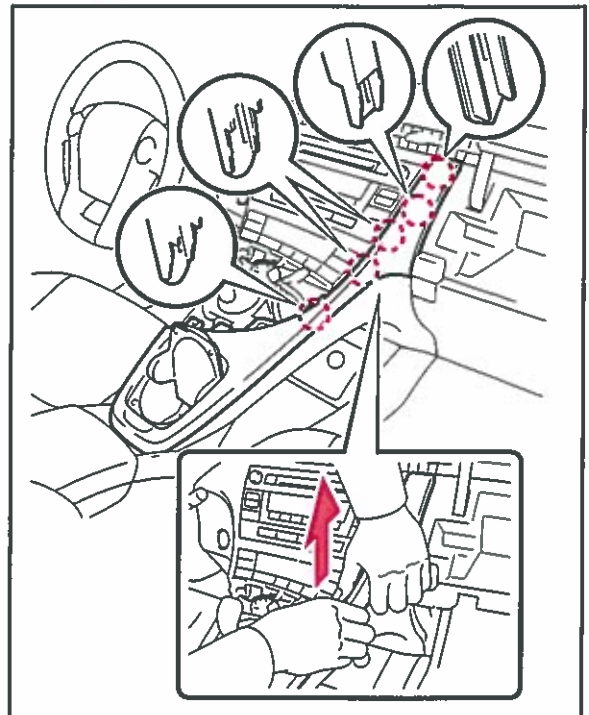

- 4. Remove the No. 1 side defroster nozzle.

Figure 4.

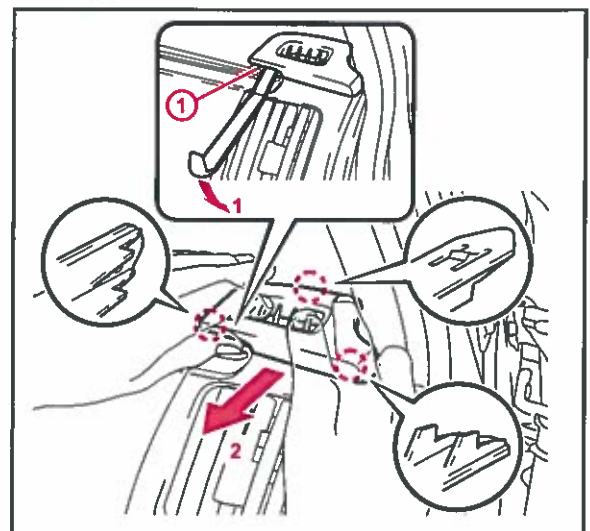

1 No. 1 Side Defroster Nozzle

Safety Connect Volume Improvement

Wire Harness Repair Procedure (Continued)

5. Remove the No. 2 instrument panel register.

Figure 5.

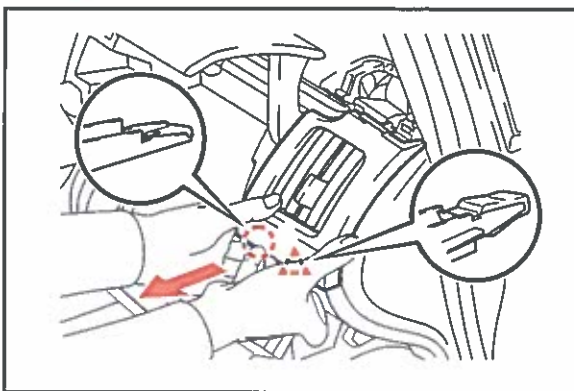
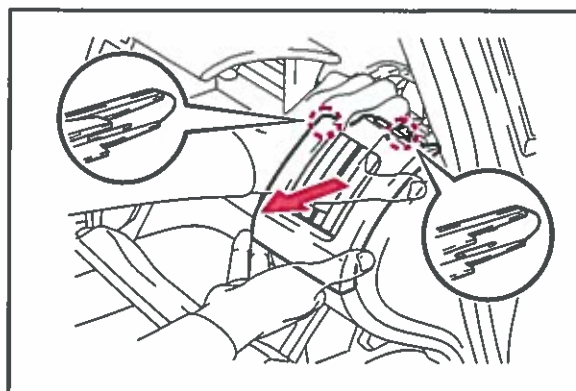

Figure 6.



6. Remove the glove compartment door.

- A. Disengage the claw and release the glove compartment door stopper.

Figure 7.

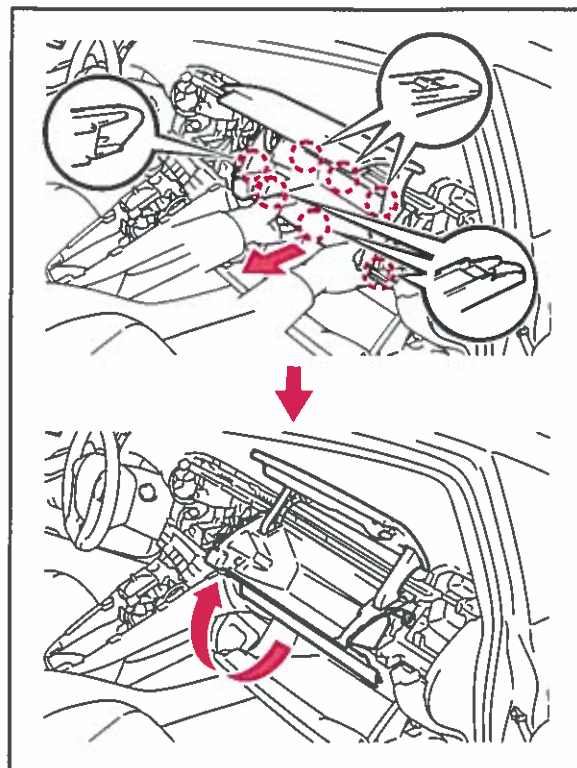

Safety Connect Volume Improvement

Wire Harness Repair Procedure (Continued)

- B. Insert the pry tool into the location shown in the illustration.

Figure 8.

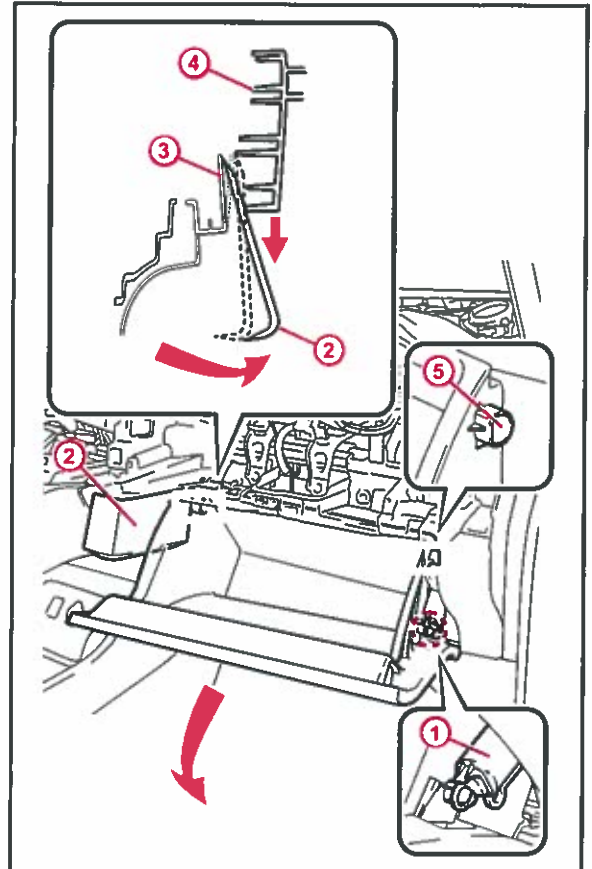

1	Glove Compartment Door Stopper Sub-assembly
2	Pry Tool
3	Lower Instrument Panel Sub-assembly
4	Glove Compartment Door Assembly
5	Stopper

Safety Connect Volume Improvement

Wire Harness Repair Procedure (Continued)

- C. Move the pry tool in the direction indicated by the arrow to bend the lower instrument panel sub-assembly and release the stopper.

Figure 9.

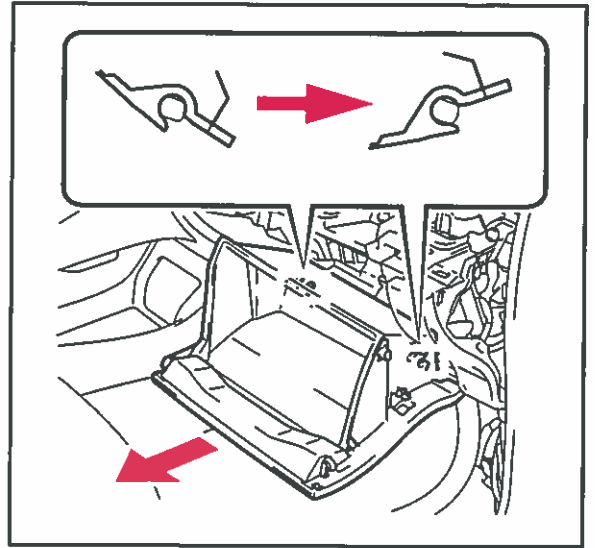

- 7. Remove the front door scuff plate RH.

Figure 10.

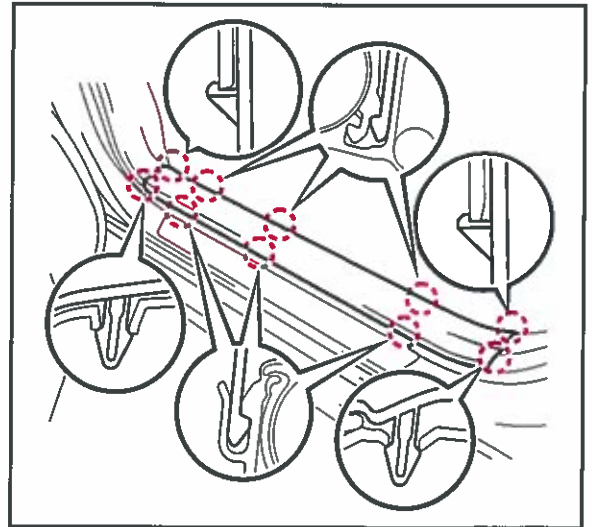

Safety Connect Volume Improvement

Wire Harness Repair Procedure (Continued)

8. Remove the cowl side trim sub-assembly RH.

Figure 11.

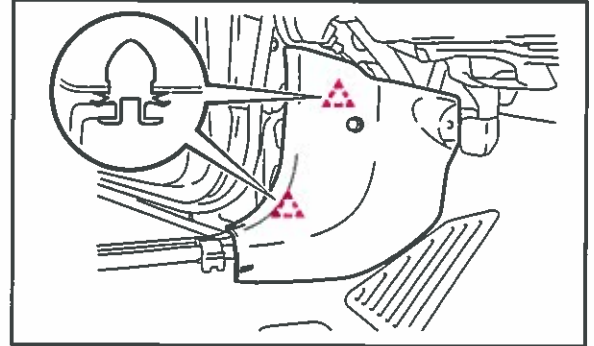

9. Remove the right (passenger) side front seat.

Refer to the Technical Information System (TIS), applicable model and model year Repair Manual:

- 2012 Prius:
Vehicle Interior – Seat – “Seat: Front Seat Assembly [\(for Power Seat\)](#) / [\(for Manual Seat\)](#): Removal”
- 2012 Prius PHV:
Vehicle Interior – Seat – “Seat: Front Seat Assembly [\(for Power Seat\)](#) / [\(for Manual Seat\)](#): Removal”

10. Remove the audio amplifier cover.

This is located just below where the passenger seat was just removed. Using a plastic pry tool, remove the 2 clips and audio amplifier cover.

Figure 12.

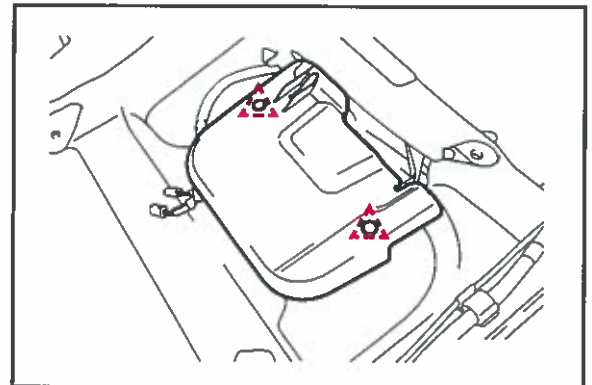

Safety Connect Volume Improvement

Wire Harness Repair Procedure (Continued)

11. Follow the next steps to install the NEW sub-wire harness. Highlighted (green) line shows the approximate route of the new sub-wire harness. The (red) circles show the location of connectors LI1 and NL2.

Figure 13.

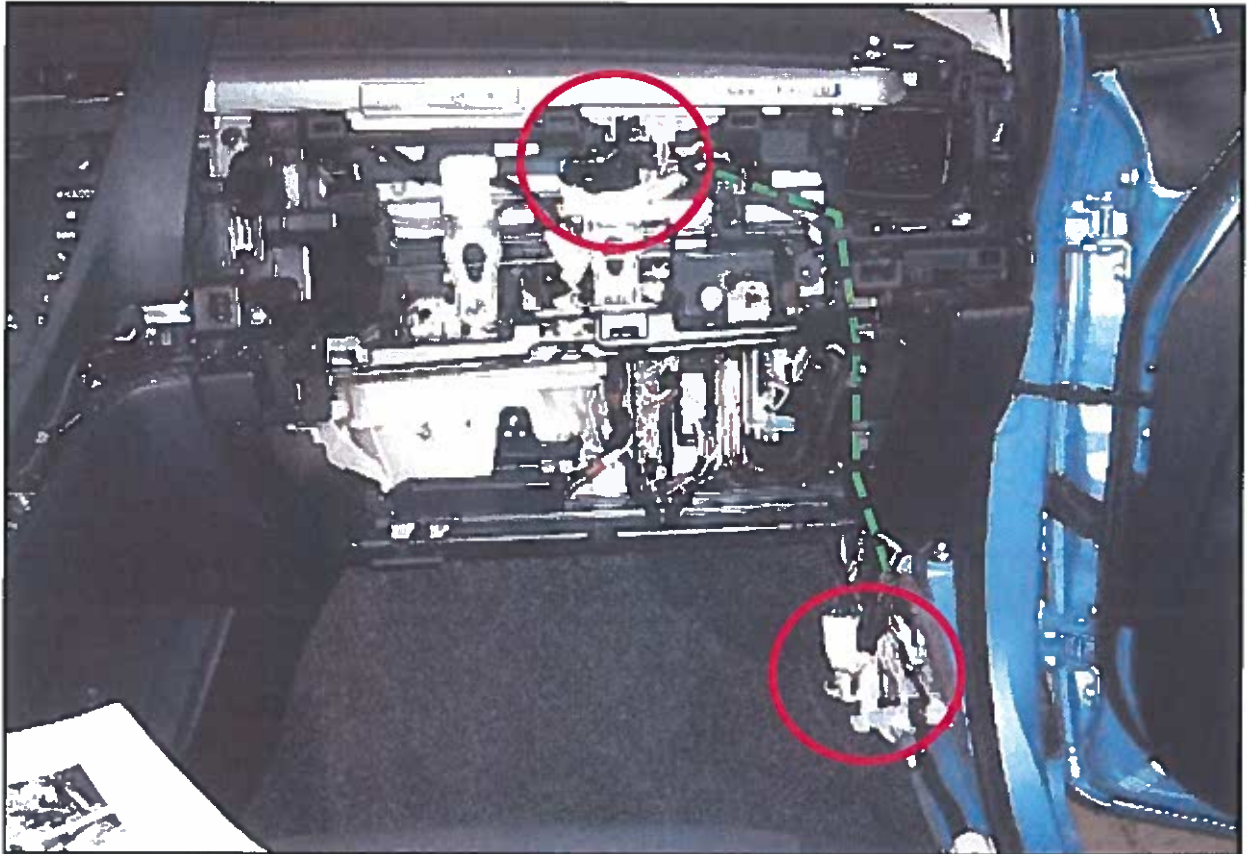

- A. Disconnect connector LI1. Install both connectors from the new sub-wire harness into both sections of connector LI1.

Figure 14.



Safety Connect Volume Improvement

Wire Harness Repair Procedure (Continued)

- B. Install sound insulation from the new sub-wire harness kit around connector LI1. The recommended width of the sound insulation is about 75 mm (3.0 in.).
- C. Route the new sub-wire harness. Attach tie wraps at red arrow location to secure the new sub-wire harness.

Figure 15.



1	Tie Wrap
---	----------

- D. Continue to route the new sub-wire harness along right side lower dash, just behind the glove box area.

Figure 16.

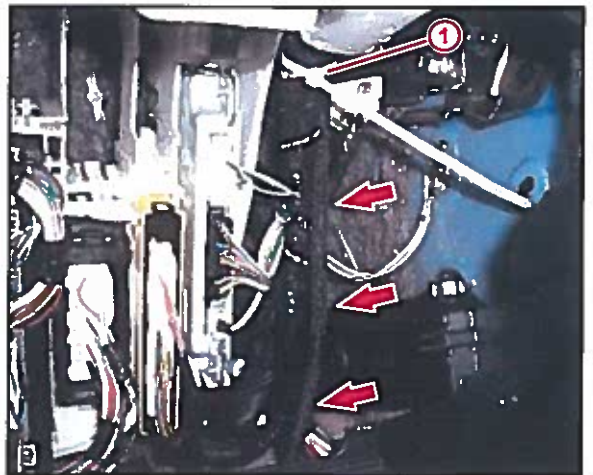

1	Tie Wrap
---	----------

Safety Connect Volume Improvement

Wire Harness Repair Procedure (Continued)

- E. Disconnect connector NL2. Install both connectors from the new sub-wire harness into both sections of connector NL2.

Figure 17.



- F. Secure the new sub-wire harness near connector NL2.

Figure 18.



Safety Connect Volume Improvement

Wire Harness Repair Procedure (Continued)

- Unplug connectors L142 and L143 from the audio amplifier.

NOTE

Connectors L142 and L143 are the only electrical connectors on the audio amplifier.

NOTICE

Connector L143 is NOT modified in this bulletin. Make sure this connector and harness are NOT damaged during the installation of the new sub-wire harness.

Figure 19. Connector L142

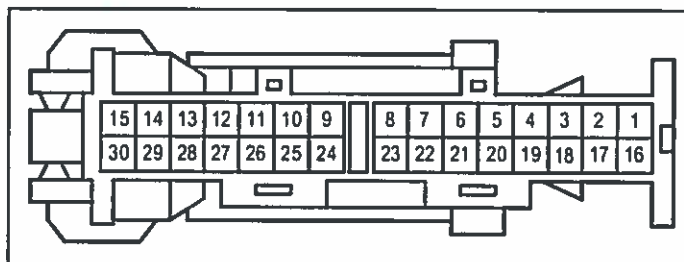
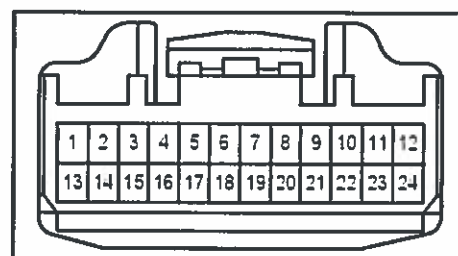

Figure 20. Connector L143



Safety Connect Volume Improvement

Wire Harness Repair Procedure (Continued)

- Identify the 4 wires which are to be cut and re-routed in the amplifier harness. These wires come from the terminals in connector L142 shown in Figure 21.

HINT

Some wires may be bound by black electrical tape. Remove the electrical tape to allow wire access.

NOTE

Clean black color residue from recently removed electrical tape.

Figure 21. Connector L142

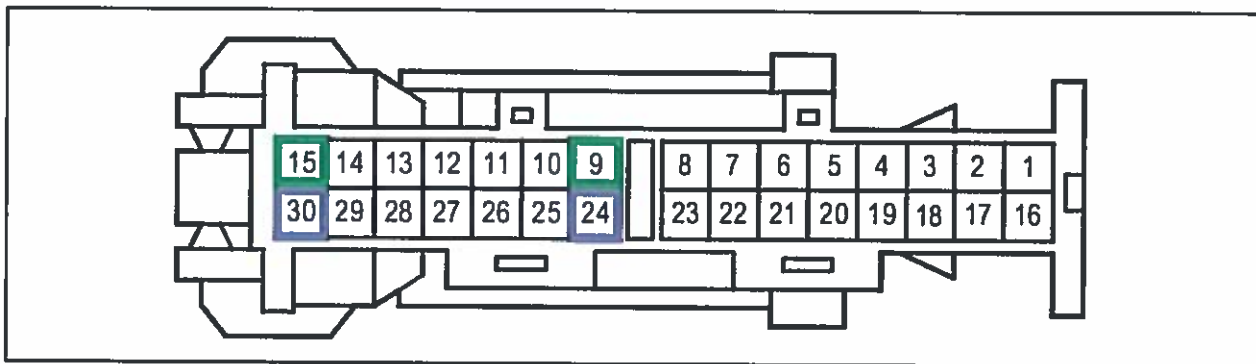
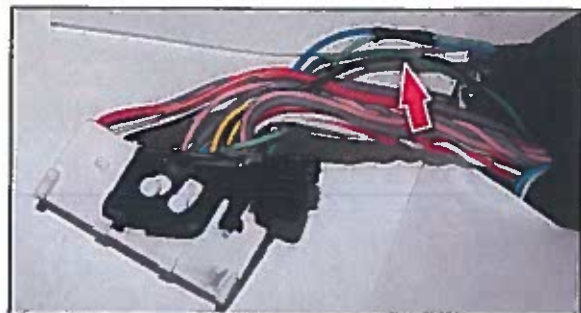

Figure 22.



Safety Connect Volume Improvement

Wire Harness Repair Procedure (Continued)

14. Mark the amplifier harness wires in the following locations with a light color ink marker pen.

NOTE

White color "correction" fluid can be used.

Mark the BLUE wire from terminal 24 and LIGHT GREEN wire from terminal 9, at 30 mm (1.18 in.) and 90 mm (3.54 in.) distances from connector L142.

NOTE

The loom on the amplifier harness may have to be moved back so that the referenced wires can be marked. The red dots indicate the mark locations.

Figure 23.

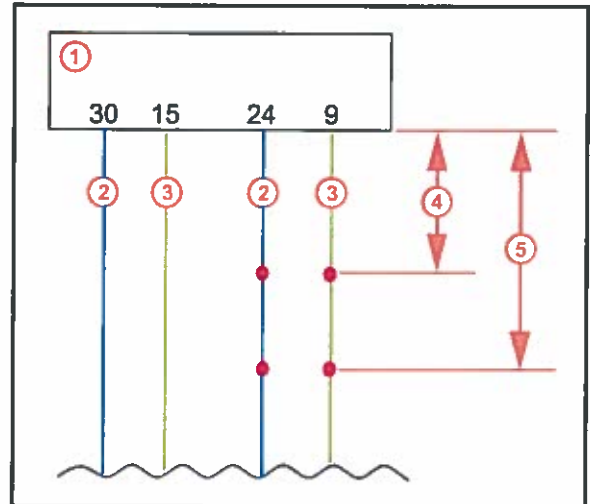

1	Connector L142, A1 Amplifier Harness
2	BLUE
3	LIGHT GREEN
4	30 mm (1.18 in.)
5	75 mm (3.00 in.)

Safety Connect Volume Improvement

Wire Harness Repair Procedure (Continued)

15. Cut the following wires on the audio amplifier harness at a distance of 60 mm (2.36 in.) from the amplifier connector L142.

WIRE COLOR	TERMINAL NUMBER
BLUE	30
LIGHT GREEN	15
BLUE	24
LIGHT GREEN	9

Figure 24.

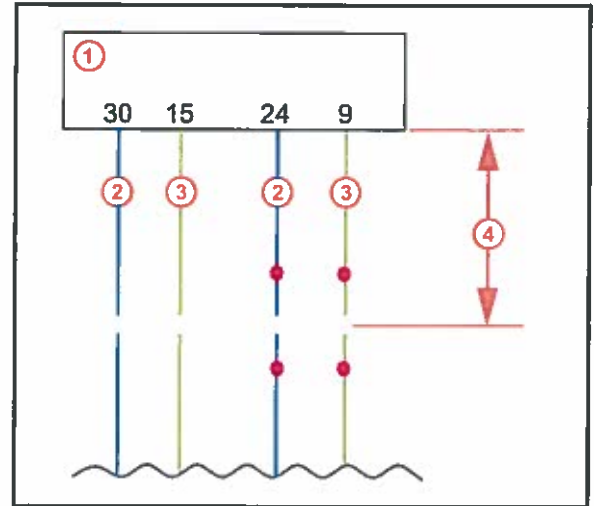

1	Connector L142, A1 Amplifier Harness
2	BLUE
3	LIGHT GREEN
4	60 mm (2.36 in.)

Figure 25.

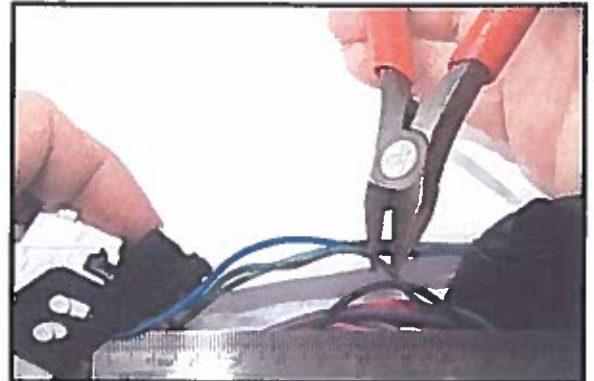

16. Remove 8 mm (0.32 in.) of insulation from the ends of the recently cut wires. There are 8 wire ends to remove insulation from.

Figure 26.

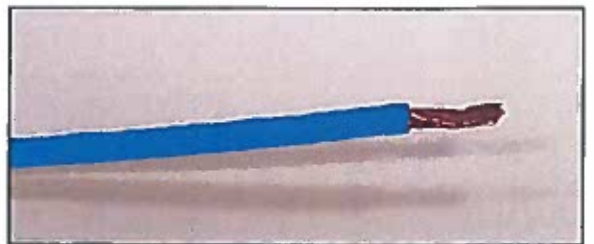

Safety Connect Volume Improvement

Wire Harness Repair Procedure (Continued)

17. Install the BLUE wire from terminal 30, splice to *marked* BLUE wire on amplifier harness that goes to the center console.
 - A. Identify the BLUE wire at the audio amplifier L142 connector, terminal 30.

Figure 27.

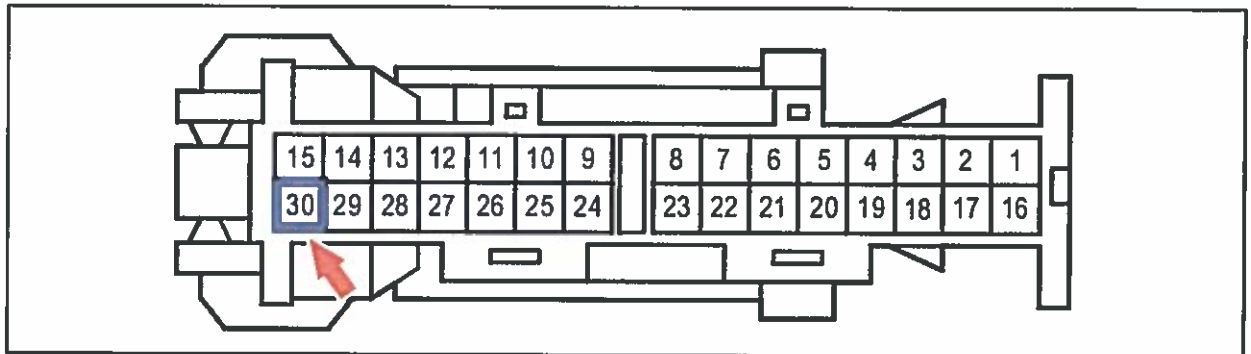

- B. Identify the *marked* BLUE wire at the amplifier harness that goes towards the center console.
 - C. Install the thermo tubing on the *marked* BLUE wire.

NOTE

Move thermo tubing away from the referenced wire ends so that thermo tubing does NOT interfere with the next wire crimping operation.

Safety Connect Volume Improvement

Wire Harness Repair Procedure (Continued)

D. Install a barrel sleeve onto each of the recently modified BLUE wires.

Figure 28.

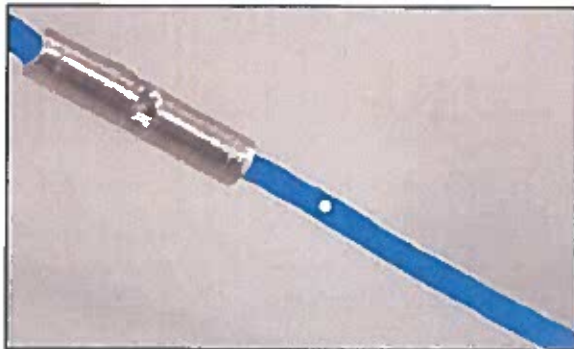
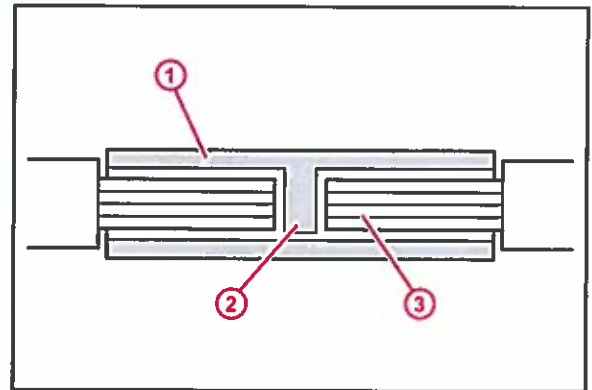

Figure 29.



1	Sleeve
2	Wire Stop
3	Wire

E. Place the sleeve into the 1.25 mm crimp die of the SST.

SST: 009042-2C100

HINT

Place the sleeve into the SST so that the split in the sleeve is in the half circle of the SST.

NOTE

SST 09042-2C100 is the *only* tool approved to perform this repair — Do NOT use any other tool to crimp the sleeve.

Figure 30.

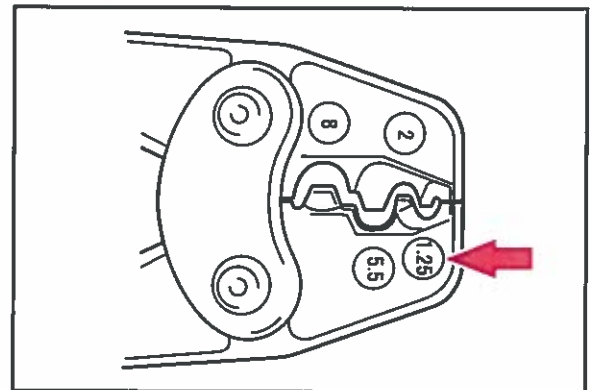

Safety Connect Volume Improvement

Wire Harness Repair Procedure (Continued)

- F. With the sleeve correctly placed in the SST and wire fully inserted into the sleeve, crimp one side of the sleeve in the area shown by closing the handles fully until they release. Crimp the other wire in the same manner.

NOTE

The SST has a ratcheting mechanism, and the handle will release when the proper crimp has been achieved.

Figure 31.

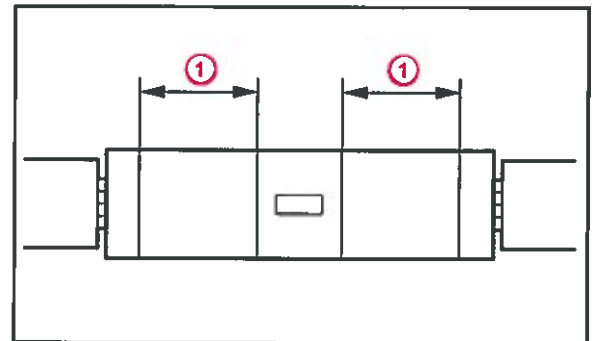

1	Crimp This Portion
----------	---------------------------

- G. Lightly tug on each connection to ensure that the wire is securely crimped.

Figure 32.

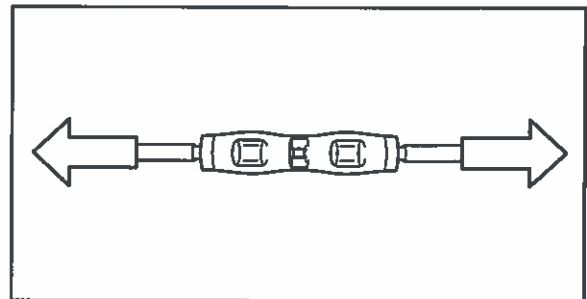

- H. Move the thermo tubing along on the wire in a manner that it covers the metal sleeve. Center the thermo tubing over the center of the barrel sleeve.

Figure 33.

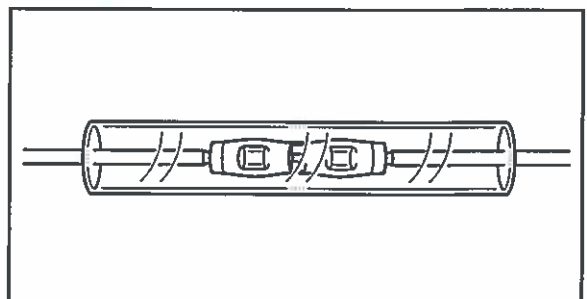

Safety Connect Volume Improvement

Wire Harness Repair Procedure (Continued)

- I. Using a heat gun, heat the thermo tubing until it shrinks and seals the repaired connection.

NOTICE

- When using the heat gun, keep the heat gun about 10 mm (0.39 in.) from the thermo tubing.
- Protect the surrounding areas (i.e., interior panels and carpet) from heat damage.

NOTE

During the sealing process, adhesive may seep from the thermo tubing. This is a normal condition and part of the sealing properties of the thermo tube.

Figure 34.

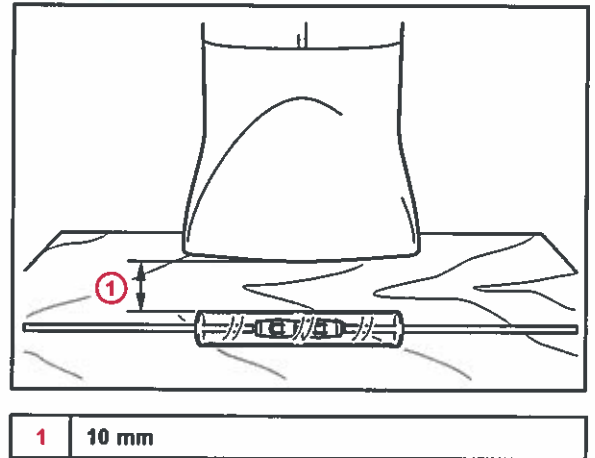
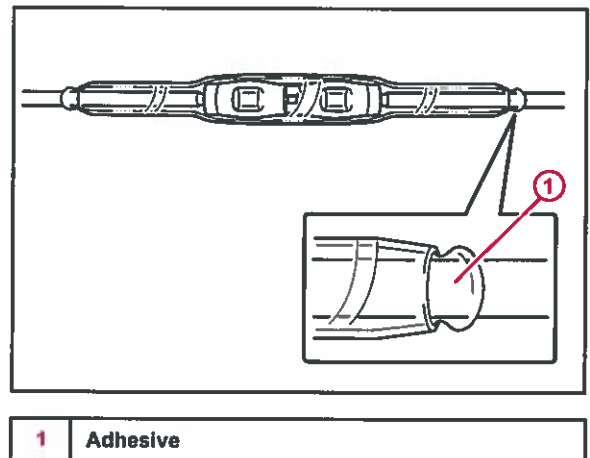

Figure 35.



Safety Connect Volume Improvement

Wire Harness Repair Procedure (Continued)

18. Install the LIGHT GREEN wire from terminal 15, splice to **marked** LIGHT GREEN wire on amplifier harness that goes to the center console.
 - A. Identify the LIGHT GREEN wire at the audio amplifier L142 connector, terminal 15.

Figure 36.

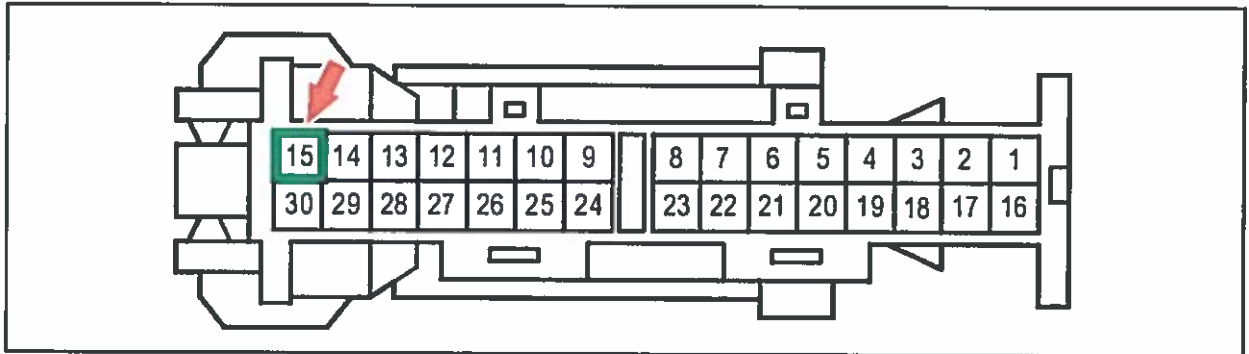

WIRE COLOR	TERMINAL NUMBER
LIGHT GREEN	15

- B. Identify the **marked** LIGHT GREEN wire at the amplifier harness that goes towards the center console.
 - C. Install the thermo tubing on the **marked** LIGHT GREEN wire.

NOTE

Move thermo tubing away from the referenced wire ends so that thermo tubing does NOT interfere with the next wire crimping operation.

Safety Connect Volume Improvement

Wire Harness Repair Procedure (Continued)

D. Install a barrel sleeve onto each of the recently modified LIGHT GREEN wires.

Figure 37.

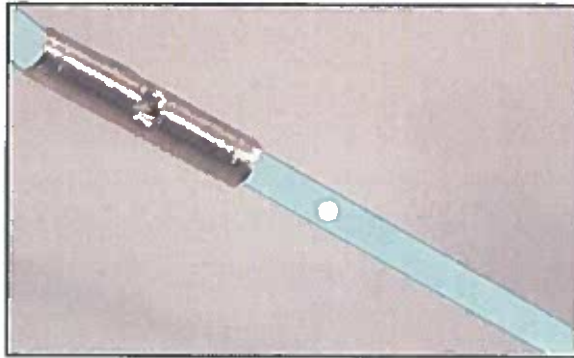
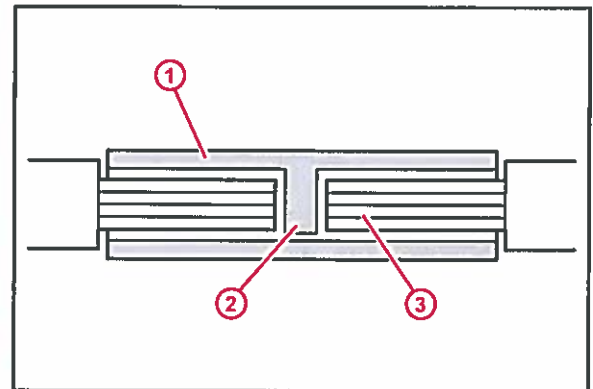

Figure 38.



1	Sleeve
2	Wire Stop
3	Wire

E. Crimp the sleeve to attach the referenced wires. Also insulate wires by applying thermo tubing on affected area. Apply steps 17E to 17I for the referenced wires.

Safety Connect Volume Improvement

Wire Harness Repair Procedure (Continued)

19. Install the *marked* BLUE wire from terminal 24, splice to BLUE wire on amplifier harness that goes to the center console.
 - A. Identify the BLUE wire at the audio amplifier L142 connector, terminal 24.

Figure 39.

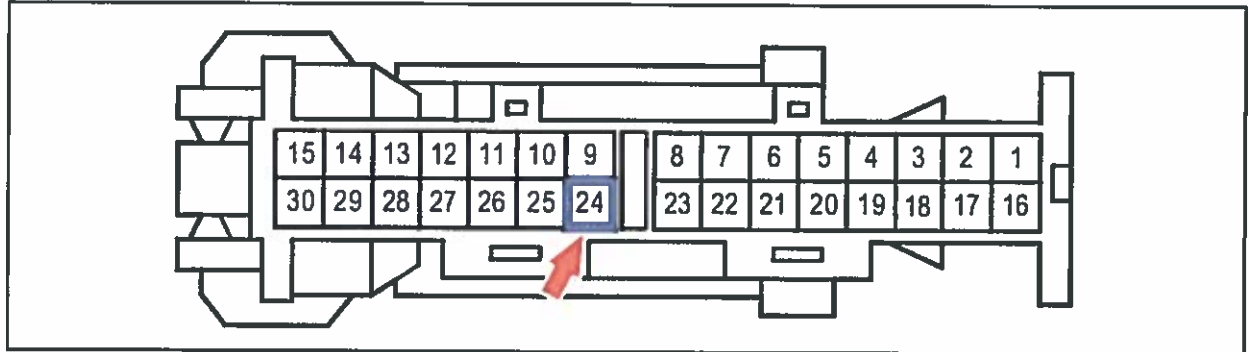

WIRE COLOR	TERMINAL NUMBER
BLUE	24

- B. Identify the BLUE wire at the amplifier harness that goes towards the center console.

NOTE

Move thermo tubing away from the referenced wire ends so that thermo tubing does NOT interfere with the next wire crimping operation.

- C. Install the thermo tubing on the BLUE wire.

Safety Connect Volume Improvement

Wire Harness Repair Procedure (Continued)

D. Install a barrel sleeve onto each of the recently modified BLUE wires.

Figure 40.

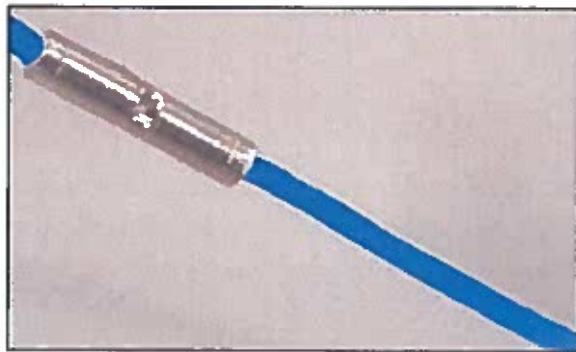
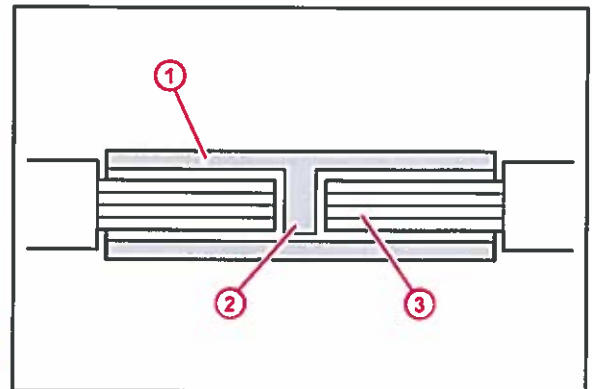

Figure 41.



1	Sleeve
2	Wire Stop
3	Wire

E. Crimp the sleeve to attach the referenced wires. Also insulate wires by applying thermo tubing on affected area. Apply steps 17E to 17I for the referenced wires.

20. Install the **marked** LIGHT GREEN wire from terminal 9, splice to LIGHT GREEN wire on amplifier harness that goes to the center console.

A. Identify the LIGHT GREEN wire at the audio amplifier L142 connector, terminal 9.

Figure 42.

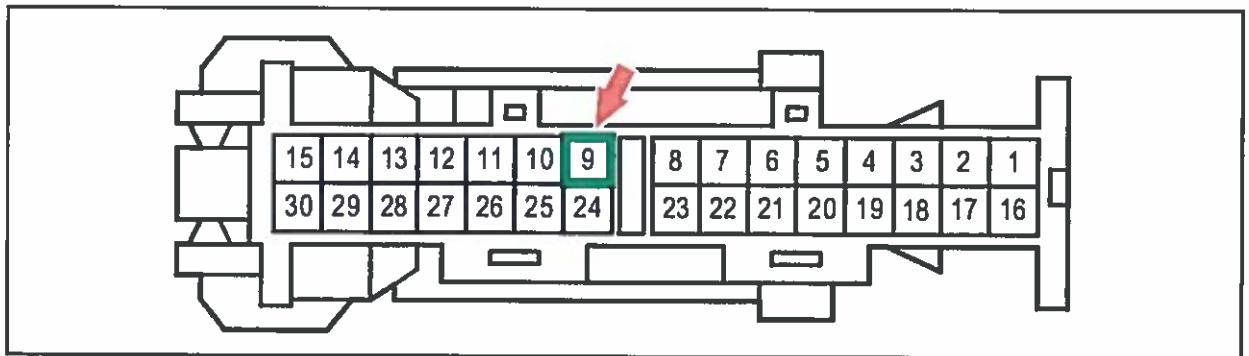

WIRE COLOR	TERMINAL NUMBER
LIGHT GREEN	9

B. Identify the LIGHT GREEN wire at the amplifier harness that goes towards the center console.

Safety Connect Volume Improvement

Wire Harness Repair Procedure (Continued)

- C. Install the thermo tubing on the LIGHT GREEN wire.

NOTE

Move thermo tubing away from the referenced wire ends so that thermo tubing does NOT interfere with the next wire crimping operation.

- D. Install a barrel sleeve onto each of the recently modified LIGHT GREEN wires.

Figure 43.

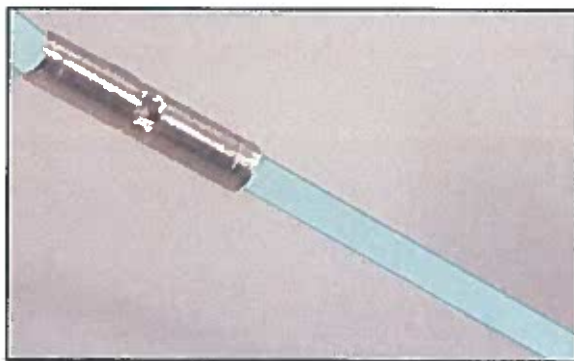
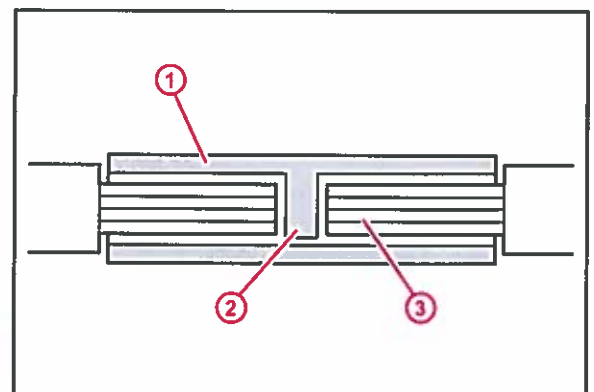

Figure 44.



1	Sleeve
2	Wire Stop
3	Wire

- E. Crimp the sleeve to attach the referenced wires. Also insulate wires by applying thermo tubing on affected area. Apply steps 17E to 17I for the referenced wires.

21. Reattach electrical connector L142 and L143 to the audio amplifier.

NOTE

Re-secure harness loom cover to harness. Use electrical tape to secure as needed.

22. Reinstall cover on audio amplifier.

Safety Connect Volume Improvement

Wire Harness Repair Procedure (Continued)

23. Install the right (passenger) side front seat.

Refer to TIS, applicable model and model year Repair Manual:

- 2012 Prius:
Vehicle Interior – Seat – “Seat: Front Seat Assembly [\(for Power Seat\)](#) / [\(for Manual Seat\)](#): Installation”
 - 2012 Prius PHV:
Vehicle Interior – Seat – “Seat: Front Seat Assembly [\(for Power Seat\)](#) / [\(for Manual Seat\)](#): Installation”
24. Reinstall the removed dash trim panels.
Perform steps 2 – 8 in reverse order.
 25. Reinstall the negative (–) battery terminal.

Section 3: Verify Repair Procedure

1. Place car into “READY ON” mode. Wait about 30 seconds to allow the navigation unit to read the HDD data.
2. Turn on radio and test audio operation. Listen to front door and front dash speakers.
Is the sound quality acceptable?
 - **YES** — Continue to step 3.
 - **NO** — STOP. Verify wiring routing from steps 17 – 20. If wire routing is correct, diagnose per Repair Manual.
3. Test Safety Connect system. Press SOS button ONCE, listen to the audio prompt, and then press AGAIN (ONCE) to terminate call.
Is Safety Connect sound level acceptable?
 - **YES** — Repair is complete.
 - **NO** — STOP. Diagnose per Repair Manual.

Safety Connect Volume Improvement

Section 4: Electrical Wiring Diagram

Figure 45.

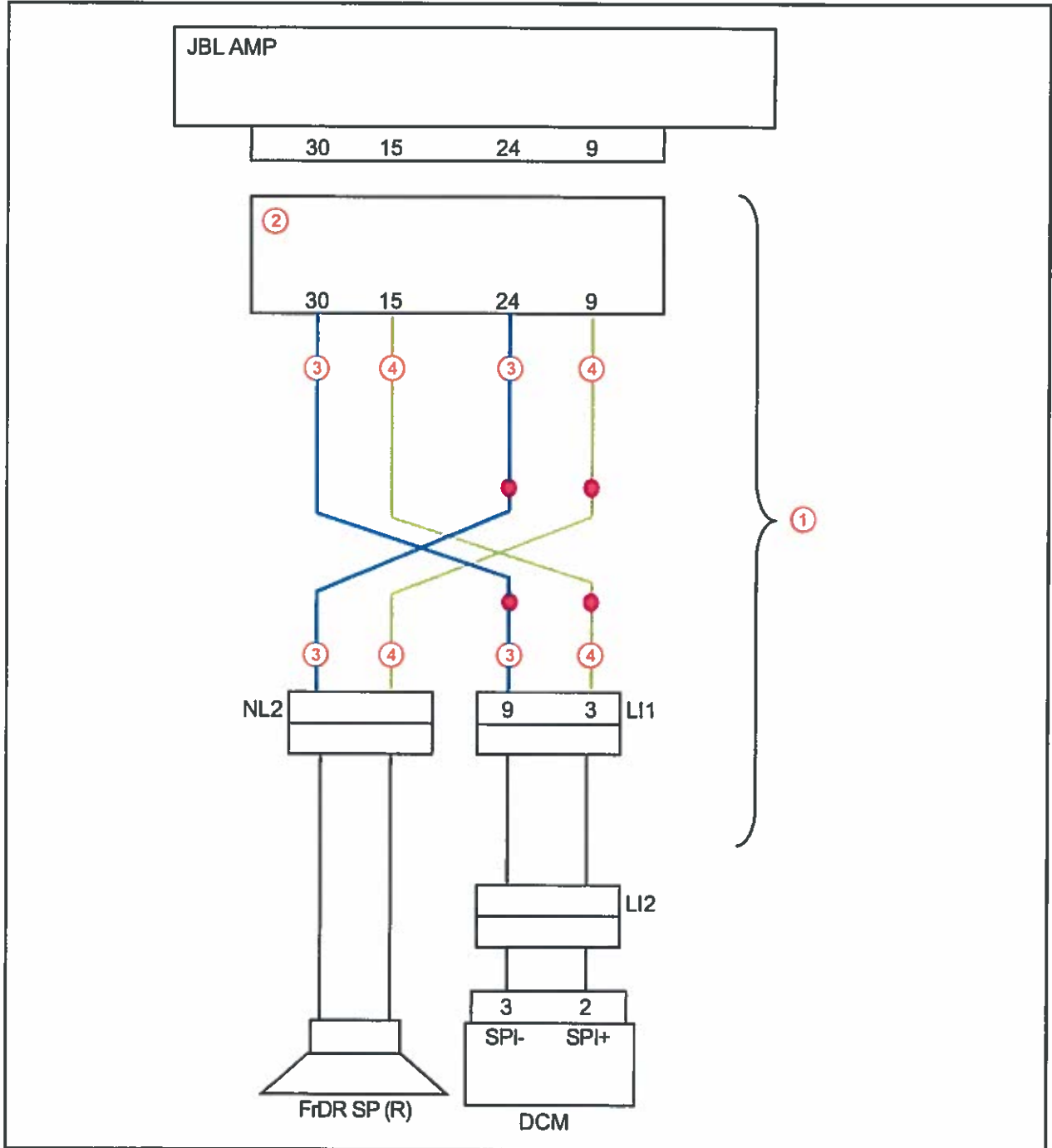

1	Instrument Panel Wire Harness
2	Connect to Amp

3	BLUE
4	LIGHT GREEN