

Front License Plate and Mounting Bracket Installation

Service Category General

Section Pre-Delivery Service

Market USA

Lexus Supports
ASE Certification 

Applicability

YEAR(S)	MODEL(S)	ADDITIONAL INFORMATION
2014	RX350, RX450H	

Introduction

The front license plate mounting bracket and 2 self-tapping screws for the 2014 model year RX 350 and RX 450h are stored in the glove compartment of the vehicle. Install the license plate and mounting bracket during Pre-Delivery Service (PDS).

Warranty Information

OP CODE	DESCRIPTION	TIME	OFP	T1	T2
N/A	Not Applicable to Warranty	–	–	–	–

Front License Plate and Mounting Bracket Installation

Installation Procedure

1. Align holes "A" of the mounting bracket with the dimples on the front bumper cover. Mark the location of holes "B" on the front bumper cover.

NOTE

- Holes "A" are used to install the mounting bracket to the bumper cover.
- Holes "B" are used to install the front license plate to the mounting bracket.

Figure 1.

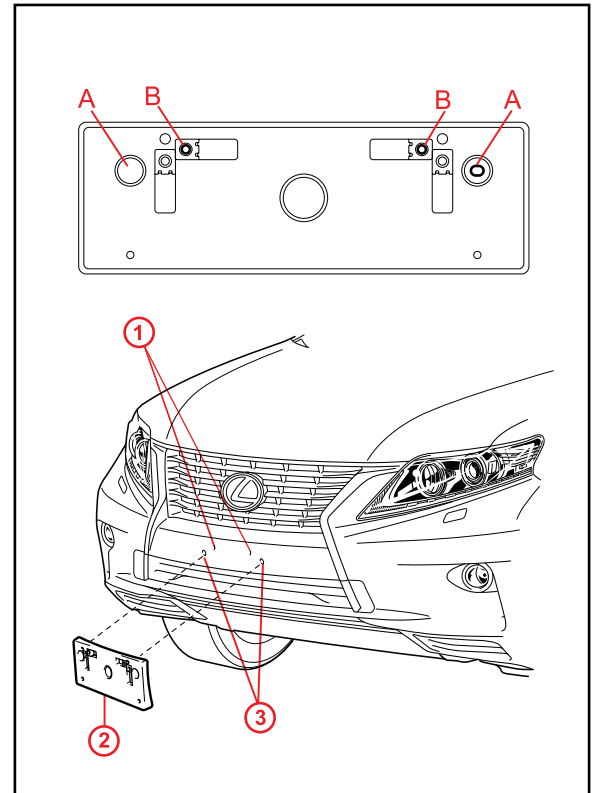

1	Mark and Drill Holes
2	Mounting Bracket
3	Dimples

2. Drill 2 relief holes with a diameter of 11.0 mm (0.43 in.) at the marks on the front bumper cover (holes "B") to prevent the license plate retaining bolt ends from contacting the cover.

NOTICE

Do NOT drill into the dimples on the front bumper cover.

Front License Plate and Mounting Bracket Installation

Installation Procedure (Continued)

3. Install the mounting bracket to the front bumper cover (holes "A") using the 2 supplied self-tapping screws.

NOTE

Be sure to tighten both the driver side and passenger side screws.

4. Install the front license plate to the mounting bracket using 2 non-corroding bolts with the following dimensions:

Nominal Length: 15.0 mm (0.59 in.)

Diameter: 6.0 mm (0.24 in.)

Figure 2.

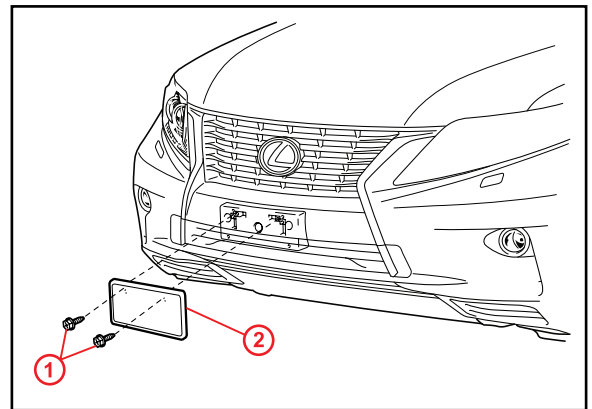

1	Bolts
2	Front License Plate

Figure 3.

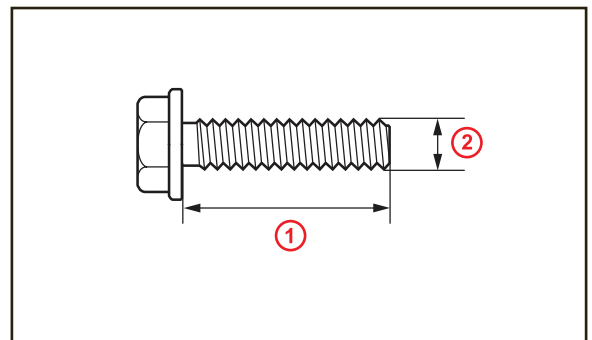

1	Nominal Length
2	Diameter