



GROUP
Engine

MODEL
Sorento (XM) 2.4L
GDI 2013MY

NUMBER
126 [Rev 1, 12/11/12]

DATE
November 2012

TECHNICAL SERVICE BULLETIN

SUBJECT: ALTERNATOR PULLEY AND TENSIONER REPLACEMENT

*NOTICE

This bulletin has been revised to include additional information. New/revised sections of this bulletin are indicated by a black bar in the margin.

This bulletin provides information related to the ECM software upgrade and alternator pulley replacement for some 2013MY Sorento vehicles, produced from February 16, 2012 to September 13, 2012, to improve idle RPM stability (750 to 680) while at a stop with A/C ON. It is important to note that the 2.4L GDI engine has a certain level of harmonic vibration while at low idle RPM which is a normal characteristic of this engine design. For confirmation that the latest reflash has been performed to a vehicle you are working on, verify ROM ID using the tables in this TSB.



⚠ CAUTION

DO NOT attempt to jack the engine up by the oil pan as this may result in damage to the oil pan. In addition, the clearance between the oil pan and oil screen pick-up is minimal and a collapsed pan can restrict oil flow into the pump assembly. Any claims associated with this type of damage are not covered under warranty and may result in a chargeback being issued to the dealer for improper repair.

File Under: <Engine>

Circulate To: General Manager Service Manager Parts Manager
 Service Advisor(s) Technician(s) Body Shop Manager Fleet Repair

SUBJECT:

ALTERNATOR PULLEY AND TENSIONER REPLACEMENT

Service Procedure:

1. Disconnect and isolate the negative terminal from the battery.

***NOTICE**

Record the customer's radio presets before starting procedure.

2. Inspect the alternator pulley to confirm the specific type of pulley installed on the vehicle. If the vehicle is equipped with the Original Alternator Dampening Pulley (OAD) (see identification chart below), perform the procedure outlined in this TSB.

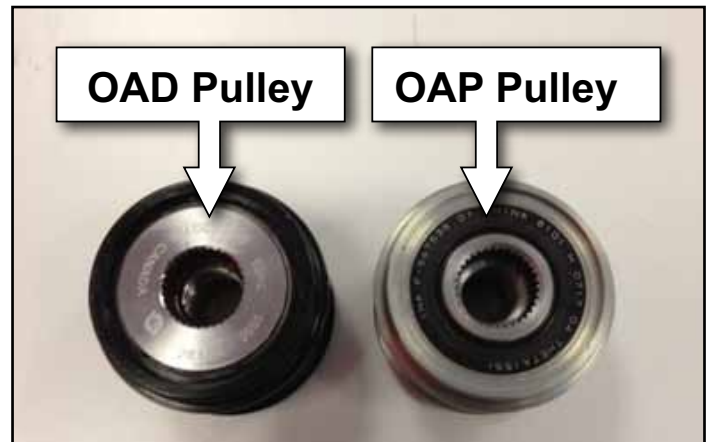

Pulley Identification Chart	
Pulley Type	Body Color
OAD	Black
OAP	Silver

***NOTICE**

If the vehicle is equipped with the Overrunning Alternator Pulley (OAP), proceed with re-flash procedure only.

SUBJECT:

ALTERNATOR PULLEY AND TENSIONER REPLACEMENT

3. Remove the alternator (A) from the vehicle.

Refer to the following section on KGIS for removal information:

SORENTO(XM) > 2013 > G 2.4 GDI > Engine Electrical System > Charging System > Alternator > Repair Procedures

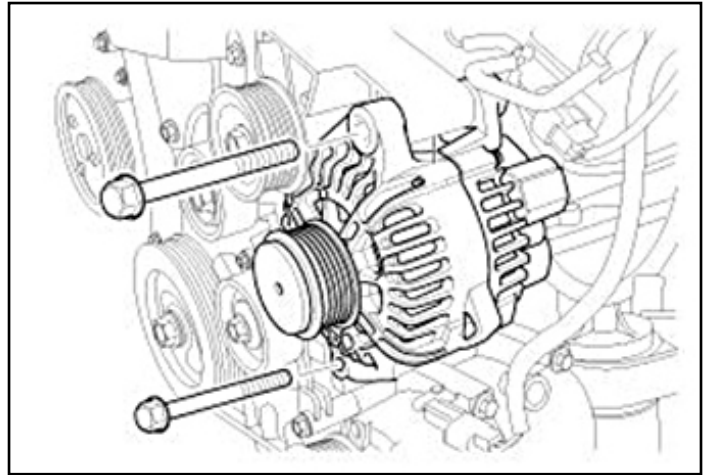

4. Secure the alternator in a shop vise as shown in the image.

CAUTION

Avoid excessively tightening the vise around the alternator mounting flange or use vise jaw pads to protect the surface integrity of the alternator mounting flange.



5. Puncture the center of the alternator pulley dust cover with a pocket screwdriver or pick tool.

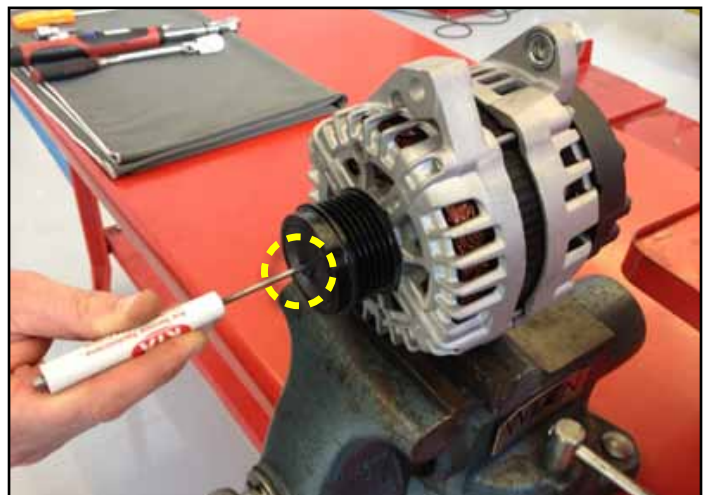

SUBJECT:

ALTERNATOR PULLEY AND TENSIONER REPLACEMENT

- Using a flat bladed screwdriver, remove the dust cover from the pulley.



- Use the Alternator Pulley Removal /Installer Kit (P/N 09373-27000), to remove the OAD alternator pulley by inserting the removal tool (A) into the pulley splines, as shown.

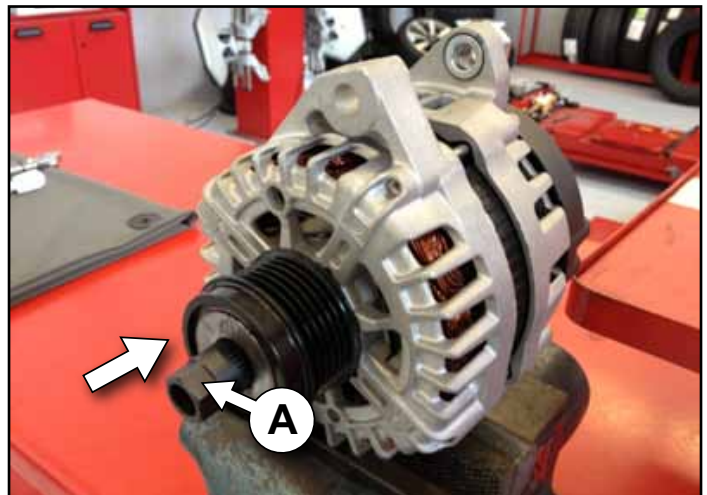

- Insert the T-50 Torx® socket (B) through the pulley removal tool (A) and into the alternator shaft.

CAUTION

Confirm the socket is fully seated to avoid damage to the alternator shaft.

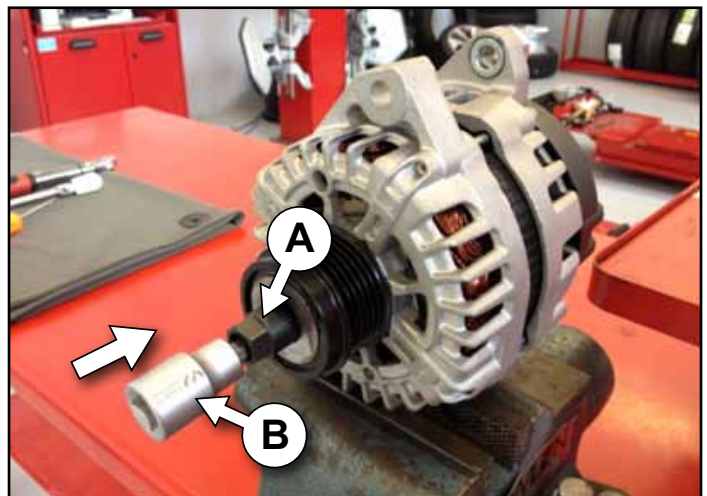

SUBJECT:

**ALTERNATOR PULLEY AND
TENSIONER REPLACEMENT**

9. Use a wrench to hold the pulley removal/ installation tool and rotate the Torx® socket **clockwise** to loosen the pulley.

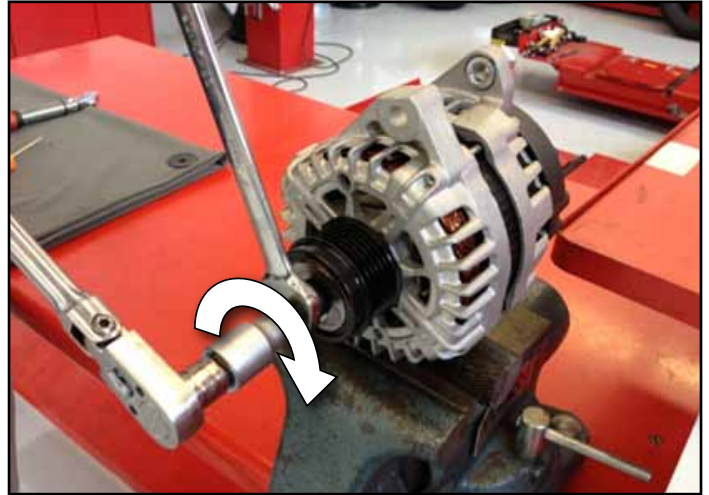

10. Remove the pulley from the alternator.

NOTE: Make sure the shaft is clean and free of debris before proceeding.

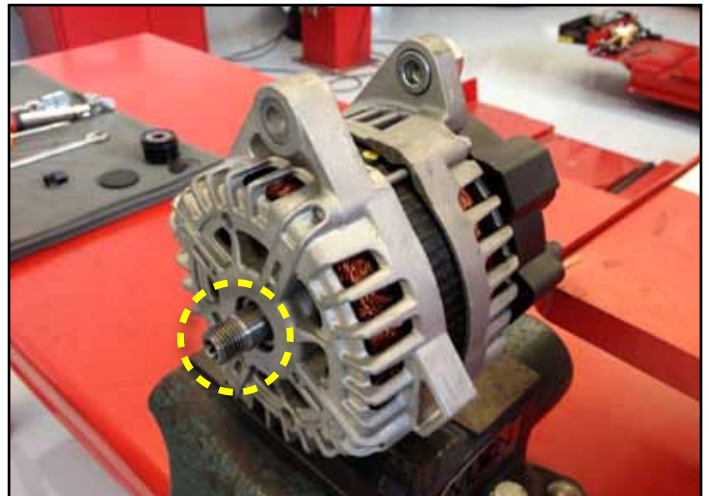

11. Install new OAP pulley onto the alternator shaft by hand. Using a wrench, pulley removal/installation tool and Torx® socket, secure the OAP pulley to the shaft by turning the socket **counter-clockwise**.

Torque pulley to the specification below:

Tightening torque: 50 lb-ft (67Nm)

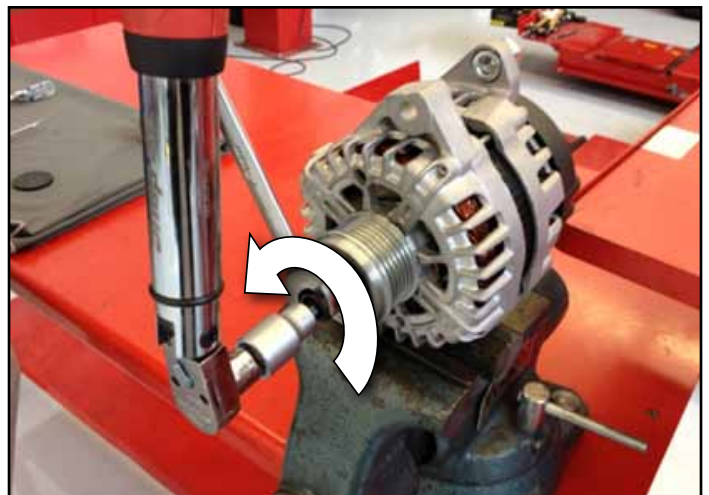

12. Make sure the alternator pulley spins freely before proceeding.

13. Install new dust cover onto pulley.



14. Remove the drive belt tensioner by removing the pulley bolt and mounting bolt.

Note: The pulley bolt is left-hand thread.



15. Install new parts by reversing the removal process.

Torque the components to the specification below:

- **Tensioner Mounting Bolt (M12)**
39.7~47 lb-ft (53.9~63.7 Nm)
- **Tensioner Pulley Bolt (M12)**
39.7~47 lb-ft (53.9~63.7 Nm)

16. Re-install the alternator by reversing the removal procedure.

Tightening torque:

Alternator M8 mounting bolt
19.5~24.6 lb-ft (26.5~33.3 Nm)

SUBJECT:

ALTERNATOR PULLEY AND TENSIONER REPLACEMENT

17.Re-install the serpentine belt.

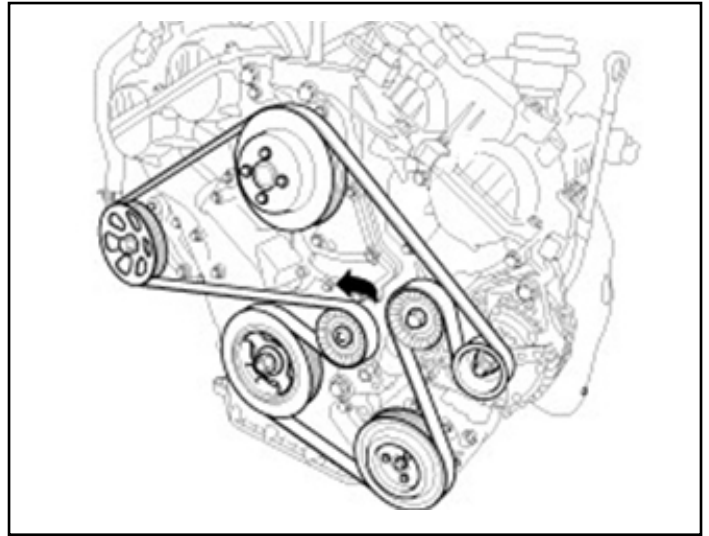

***NOTICE**

Reprogram the customer's radio presets as recorded earlier.

⚠ CAUTION

Before attempting an ECM upgrade on any Kia model, make sure to first determine whether the particular model is equipped with an immobilizer security system. Failure to follow proper procedures may cause the PCM to become inoperative after the upgrade and any claims associated with this repair may be subject to chargeback.

ECM Upgrade Procedure:

To correct this condition, the ECM should be reprogrammed using the GDS download as described in this bulletin.

UPGRADE EVENT NAME

194. XM 2.4 GDI IDLE RPM STABILITY IMPROVEMENT (VER. 2)

SUBJECT: ALTERNATOR PULLEY AND TENSIONER REPLACEMENT

***NOTICE**

- A fully charged battery is necessary before ECM upgrade can take place. It is recommended that the Midtronics GR8-1299 system be used in ECM mode during charging. **DO NOT** connect any other battery charger to the vehicle during ECM upgrade.
- All ECM upgrades must be done with the ignition key in the 'ON' position.
- Be careful not to disconnect any cables connected to the vehicle or GDS during the ECM upgrade procedure.
- **DO NOT** start the engine during ECM upgrade.
- **DO NOT** turn the ignition key 'OFF' or interrupt the power supply during ECM upgrade.
- When the ECM upgrade is completed, turn the ignition 'OFF' and wait 20 seconds before starting the engine.
- **ONLY** use approved ECM upgrade software designated for the correct model, year.

**ROM ID Information Table:
Upgrade event #194:**

MODEL	MY	IMMO	ECM P/N	ROM ID	
			A/T	PREVIOUS	NEW
XM 2.4 GDI	2013	No (-)	39113-2G761(2WD) 39114-2G761(4WD)	XDC4ME0A XDC4MEAA XDC4MEAB XDC4MEAC XDC4ME0A XDC4MEAA XDC4MEAB XDC4MEAC	XDC4MEAD
		Yes(+) 	39113-2G771(2WD) 39114-2G771(4WD)	XDC4RE0A XDC4REAA XDC4REAB XDC4REAC XDC4RE0A XDC4REAA XDC4REAB XDC4REAC	XDC4READ

SUBJECT: ALTERNATOR PULLEY AND TENSIONER REPLACEMENT

1. Connect the power supply cable to the GDS tool.

***NOTICE**

If attempting to perform the ECM upgrade with the power supply cable disconnected from the GDS tool, be sure to check that the GDS tool is fully charged before ECM upgrade. If the GDS tool is not fully charged, failure to perform the ECM upgrade may occur. Therefore, it is strongly recommended that the power supply be connected to the GDS tool.

2. Connect the USB cable between the VCI and the GDS tool.

***NOTICE**

When performing the ECM upgrade using the GDS tool, wireless communication between the VCI and GDS tool is not available. Therefore, be sure to connect the USB cable between the VCI and the GDS tool.

3. Connect the Main 16-pin DLC cable (GHDM – 241000) to the VCI.
4. Connect the Main 16-pin DLC cable (GHDM – 241000) to the OBD-II connector, located under the driver's side of the instrument panel.



5. With the ignition key ON, turn ON the VCI and GDS tool. Access the GDS vehicle identification number (VIN) screen and configure the vehicle using the VIN Auto Detect function.



SUBJECT: ALTERNATOR PULLEY AND TENSIONER REPLACEMENT

- Once back at the GDS Main Screen, select ECU Upgrade from the bottom right-hand corner. Next select Auto Mode, and then Engine. Perform the ECM upgrade in accordance with normal GDS tool ECM upgrade procedures.

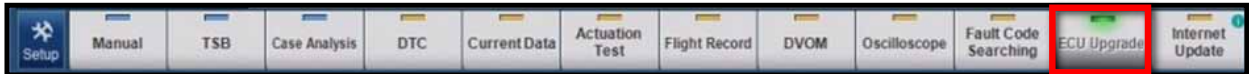

***NOTICE**

Do **NOT** attempt to perform a Manual Mode upgrade unless Auto Mode fails. Always follow the instructions given on the GDS tool in either Auto or Manual mode. See table for Manual Mode passwords.

⚠ CAUTION

Before attempting an ECM upgrade on any Kia model, make sure to first determine whether the particular model is equipped with an immobilizer security system. Failure to follow proper procedures may cause the PCM to become inoperative after the upgrade and any claims associated with this repair may be subject to chargeback.

MANUAL MODE ECM UPGRADE PASSWORDS: Upgrade event #194:



Menu	Password
XMA GDI 2.4 - IMMO : 39113/39114-2G761	2761
XMA GDI 2.4 + IMMO : 39113/39114-2G771 	2771

- When the GDS tool reports that the ECM upgrade has been successfully completed, click OK, turn OFF the ignition key, and wait at least 10 seconds before attempting to start the engine.
- Check for Diagnostic Trouble Codes using the GDS and erase any DTCs stored such as EPS, ESC, and TPMS. Due to CAN BUS multiple DTCs may be set during reprogramming.
- Start the engine to confirm proper operation of the vehicle.



AFFECTED VEHICLE PRODUCTION RANGE:

Model	Production Date Range
Sorento (XM)	February 16, 2012 to September 13, 2012

SUBJECT:**ALTERNATOR PULLEY AND
TENSIONER REPLACEMENT****REQUIRED PART:**

Part Name	Part Number	Figure
Pulley	37322 2G500	
Tensioner	25281 25000	

REQUIRED SST:

Alternator Pulley Removal/Installation Kit (P/N 09373-27000)	
Pulley Removal Tool	T-50 Torx® Socket
	

WARRANTY CLAIM INFORMATION:

Claim Type	Causal P/N	Qty.	N Code	C Code	Repair Description	Labor Op Code	Op Time	Related Parts	Qty.
W	37322 2G500	1	N02	C40	(TSB ENG 126) Idle Improvement (Alt Pulley & Reflash)	37320F00*	1.6 M/H	25281 25000	1

****Includes alternator pulley, tensioner replacement and reflash of ECM.***

Note: If ONLY the ECM Upgrade Procedure is performed, submit claim using Op Code 39110R00 for 0.3 Op Time (This Op Code & Time only applies to vehicles in the production date range of this TSB and that had a new alternator with OAP installed during a previous repair).