

ATTENTION:

- GENERAL MANAGER
- PARTS MANAGER
- CLAIMS PERSONNEL
- SERVICE MANAGER

IMPORTANT - All Service Personnel Should Read and Initial in the boxes provided, right.



QUALITY DRIVEN® SERVICE

SERVICE BULLETIN

APPLICABILITY: 2011-2012MY Forester Models with FB Engine **NUMBER:** 02-131-12R
SUBJECT: Oil Seepage Diagnosis and Repair Procedures **DATE:** 07/18/12
REVISED: 10/02/12

INTRODUCTION

The purpose of this Bulletin is to provide procedures for the diagnosis and repair of oil seepage which may be coming from the timing chain cover, front camshaft cap, camshaft carrier and / or upper oil pan.

There are five areas that should be closely inspected if an oil leak is reported by the customer:

1. The 6mm tapped hole casting boss area in the left-hand camshaft cap
2. The sealing surfaces between either the left or right-hand camshaft cap and camshaft carrier
3. The sealing surfaces between the cylinder head and camshaft carrier
4. The sealing surface between the upper oil pan and the engine block
5. The sealing surfaces of the front timing chain cover

Note: Refer to the April 2011 issue of TIPS for more information on Fluid Leak Detection.

If oil seepage is verified coming from the 6mm threaded hole in the left-hand camshaft cap, install the specified bolt and flat washer.

Bolt: Part# 800206180

Washer: Part# 031106000

Tightening Torque: 6.4 +/- 0.5 Nm
(57 +/- 4 inch-pounds)

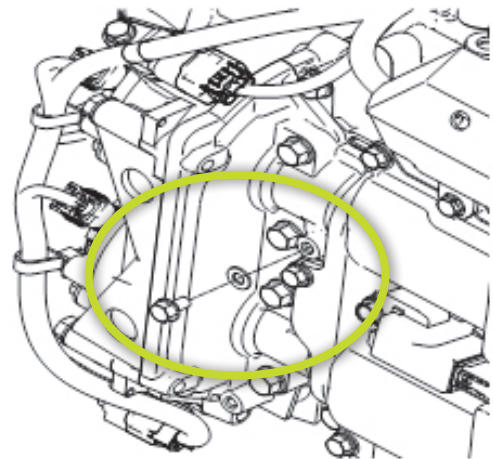

Continued...

CAUTION: VEHICLE SERVICING PERFORMED BY UNTRAINED PERSONS COULD RESULT IN SERIOUS INJURY TO THOSE PERSONS OR TO OTHERS.

Subaru Service Bulletins are intended for use by professional technicians ONLY. They are written to inform those technicians of conditions that may occur in some vehicles, or to provide information that could assist in the proper servicing of the vehicle. Properly trained technicians have the equipment, tools, safety instructions, and know-how to do the job correctly and safely. If a condition is described, DO NOT assume that this Service Bulletin applies to your vehicle, or that your vehicle will have that condition.

SUBARU OF AMERICA, INC. IS "ISO 14001 COMPLIANT"

The international standard for excellence in Environmental Management Systems. Please recycle or dispose of automotive products in a manner that is friendly to our environment and in accordance with all local, state and federal laws and regulations.

If oil seepage is verified coming from the front camshaft cap or cam carrier as shown in the photos below, remove the cam cap and clean both surfaces thoroughly before applying sealer. **Note:** The 2 o-rings between the camshaft cap and the cam carrier will need to be replaced as they are not re-usable.

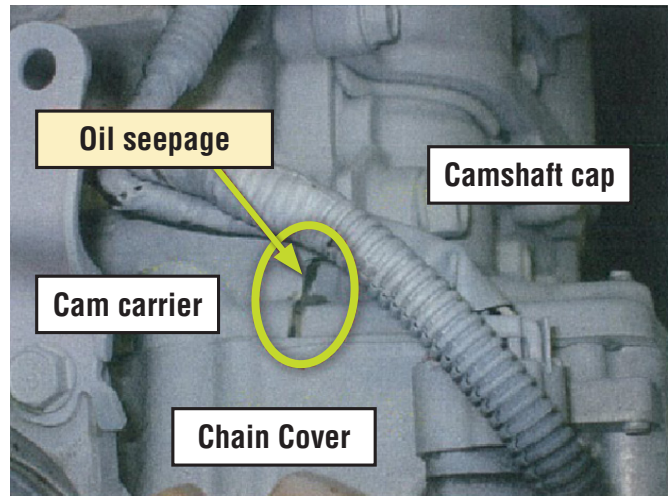
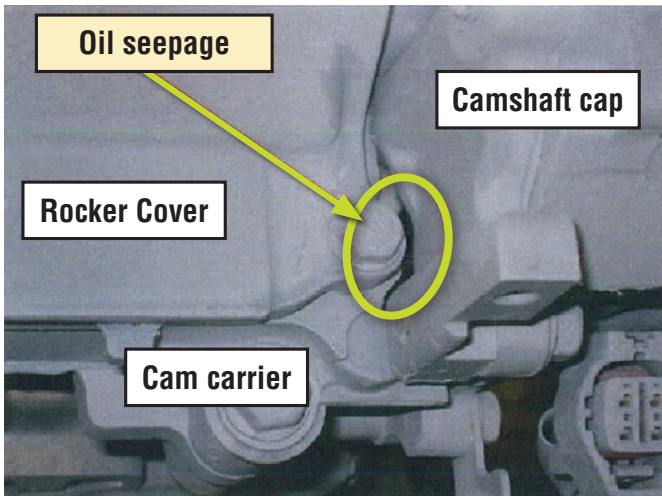

Apply Liquid Gasket, ThreeBond 1280B, (Part No. SOA5499100) or equivalent* as shown below:

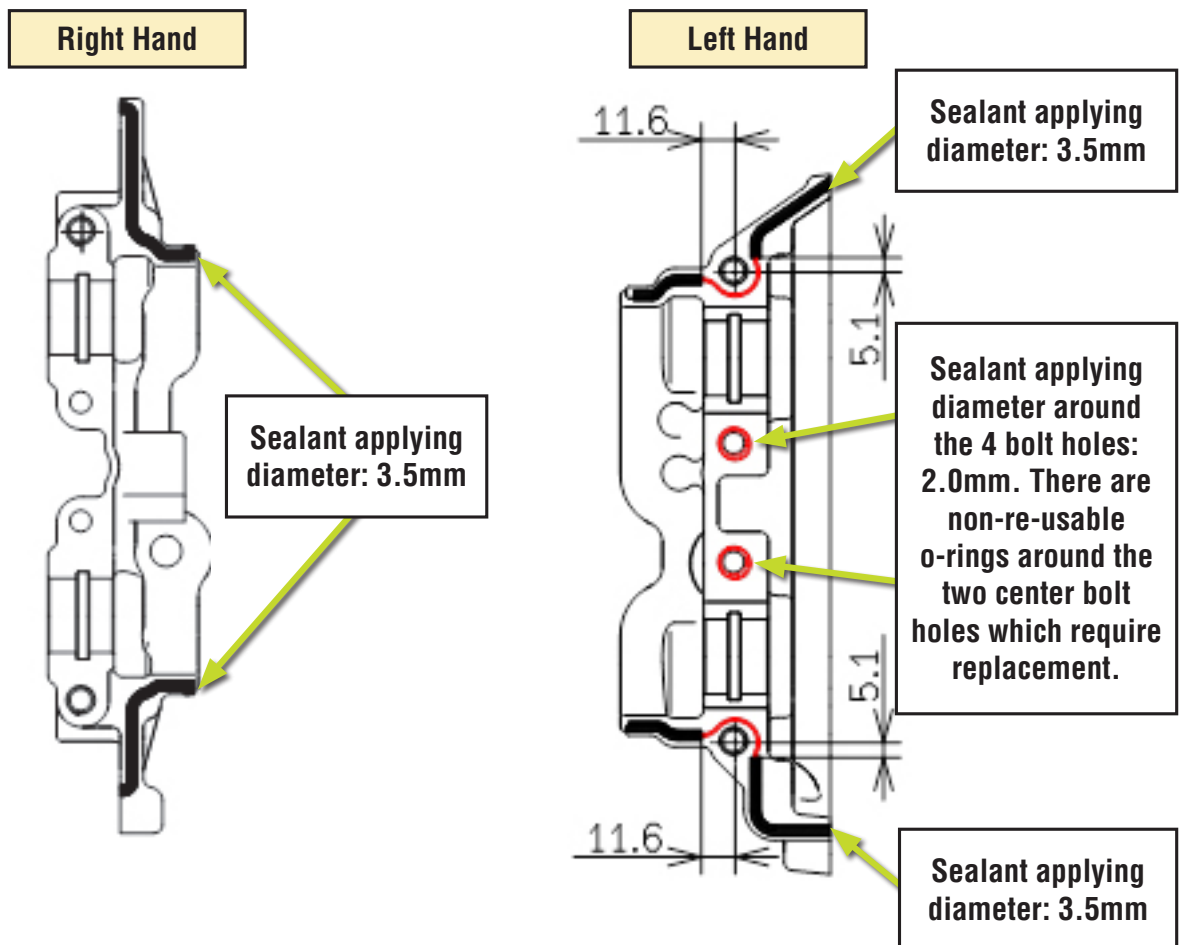

Continued...

If oil seepage is verified coming from between the cam carrier and the cylinder head as shown in the photos below, remove the cam carrier. Clean the machined sealing surfaces thoroughly and then re-seal using Liquid Gasket ThreeBond 1280B, (Part No. SOA5499100) or equivalent*. As shown in the photos below, the o-rings between the cam carrier and the cylinder head will need to be replaced as they are not re-usable. This would also be a good time to clean the Active Valve Control System (AVCS) filter screens which are contained in the cam carriers. **NOTE:** The filter screens are one-time use and must be replaced if they need to be removed. The replacement filter part# is 14451AA050.

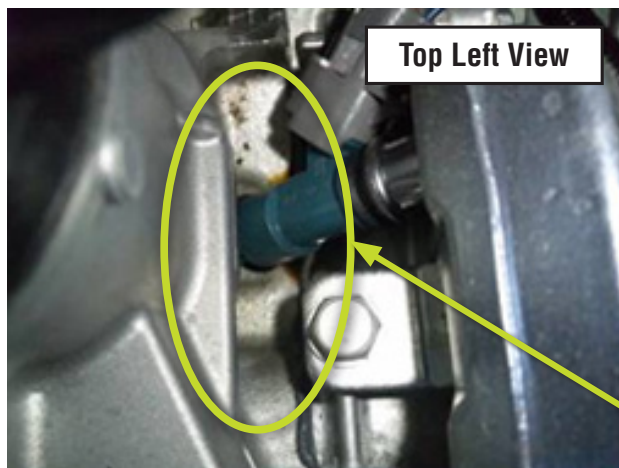

Cam carrier seepage seen from top left and lower right side of engine

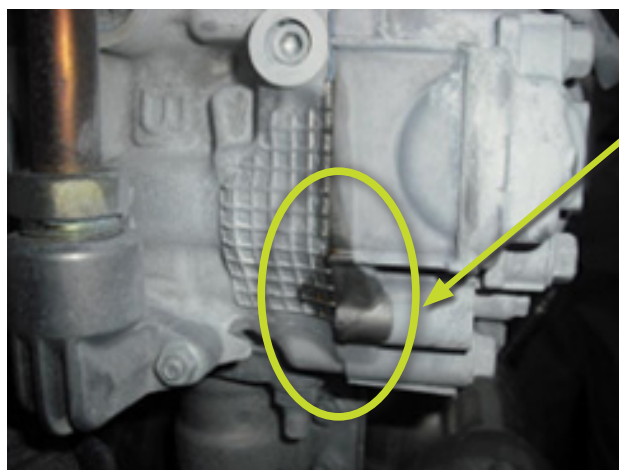

Continued...



Cam carrier o-rings requiring replacement

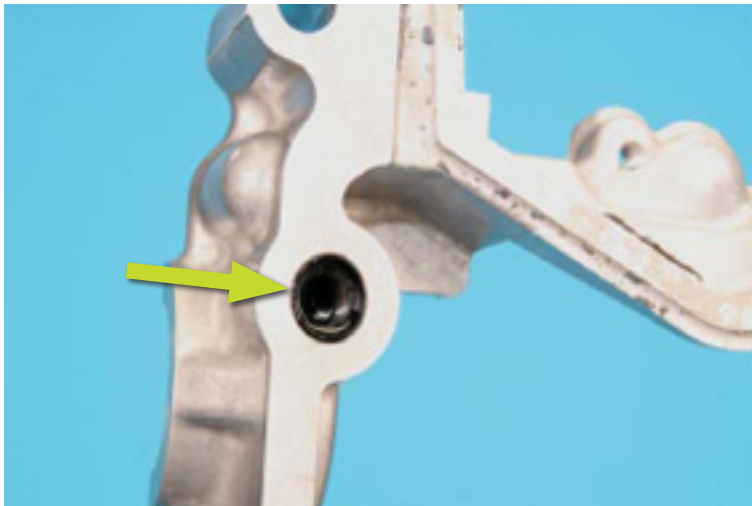

AVCS filter screen in cam carrier

If you find engine oil seepage between the cylinder block and upper oil pan, remove the upper oil pan, clean the machined sealing surfaces thoroughly and then re-seal using Liquid Gasket ThreeBond 1280B, (Part No. SOA5499100) or equivalent*. **Note:** The o-rings between the upper oil pan and the cylinder block along with those between the upper and lower oil pan will need to be replaced as they are not re-usable.

Continued...

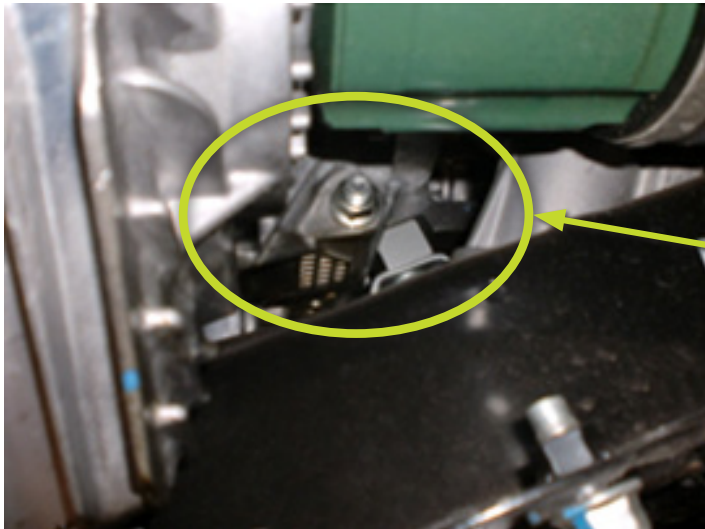
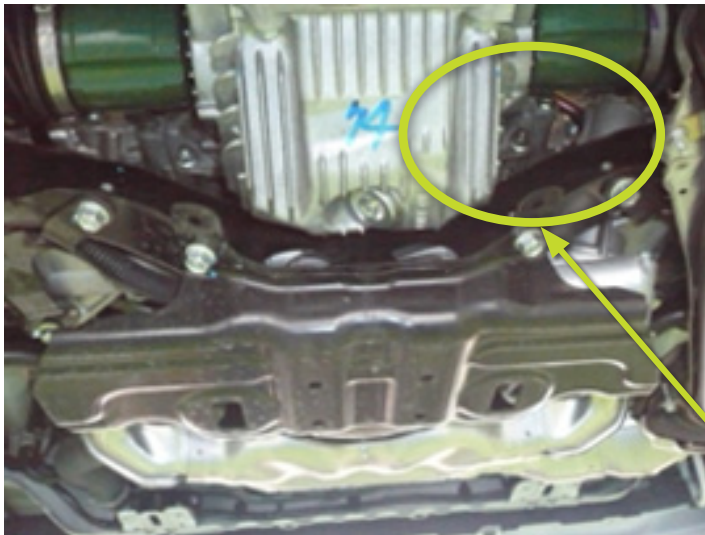

As viewed from the rear, oil seepage from the upper pan to engine block sealing area may be present in these areas.

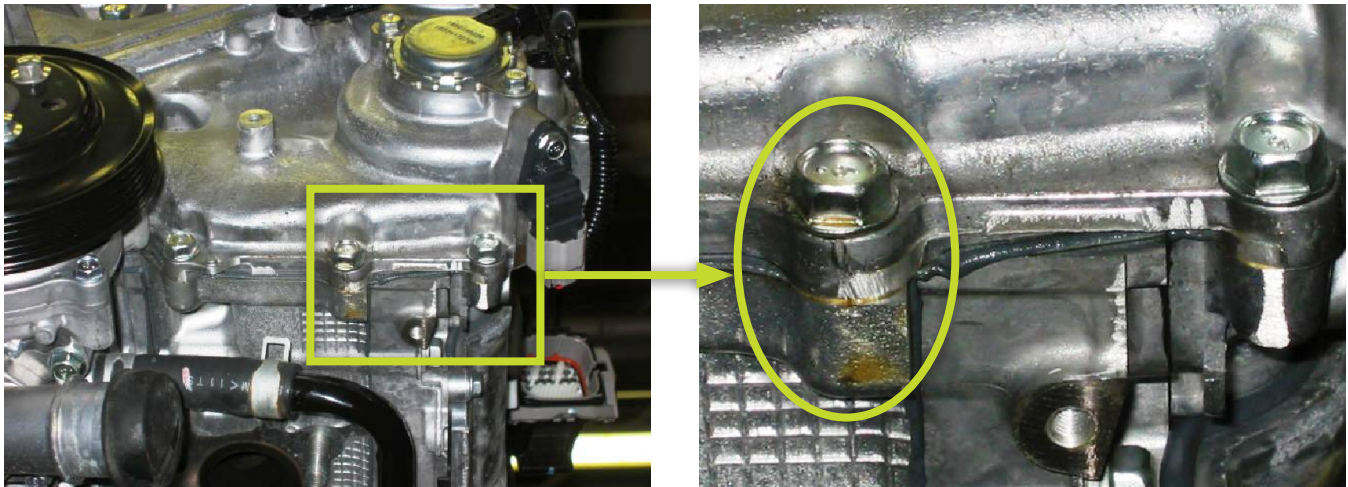

Photo shows seepage from upper oil pan to engine block sealing surfaces.

Continued...

Front Timing Chain Cover resealing procedures:

Note: Only reseal the front chain cover AFTER confirming there is no oil seepage coming from the cam retainer cap (area 1) as previously described.



1. If there are no oil droplets found on the engine under-cover or the lower radiator hose, thoroughly clean the chain cover sealing area along with the surrounding cylinder head and crankcase areas. Re-check for oil seepage again at the next service interval.
2. If the front chain cover is leaking and needs to be resealed, follow the repair procedure in the applicable Service Manual. Thoroughly clean and inspect the sealing surfaces then re-seal using Liquid Gasket ThreeBond 1280B, (Part No. SOA5499100) or equivalent*.

*See Service Bulletin 01-167-08 for recommended and alternative sealing materials.

COUNTERMEASURES

VEHICLE	INSPECTION AREA	COUNTERMEASURE	STARTING VIN#	STARTING ENGINE #
Forester	1	Elimination of 6mm tapped hole in boss of camshaft cap	C*447908	0266216
	2	Enhanced cleaning procedure for sealing surface of camshaft cap	C*411592	0156924
	3 and 4	Additional sealer added	C*468399	0345502
	5	Enhanced cleaning procedure for sealing surface of chain cover	C*468399	0345489

Continued...

WARRANTY/CLAIM INFORMATION

For vehicles within the Basic New Car Limited Warranty period, refer to the Subaru Warranty Wizard® for claim submission information. Use the chart below for the 6mm bolt installation procedure outlined on pg. 1 of this bulletin.

LABOR DESCRIPTION	LABOR OPERATION #	FAIL CODE	LABOR TIME
LH Cam Cap Boss Oil Seepage Repair	A243-611	AFR-34	0.3

NOTE: Liquid gasket ThreeBond 1280B can be claimed using part number SOA635065, quantity one (1) per repair order. This part number is non-orderable and used for claim purposes only.