



Reference:

ITB11-039e

Date:

June 8, 2012

VOLUNTARY SAFETY RECALL CAMPAIGN 1997-2003 QX4 IN SALT STATES FRONT STRUT HOUSING CORROSION

This campaign bulletin has been amended. The Title, PARTS INFORMATION and CLAIMS INFORMATION have been amended. The SERVICE PROCEDURE has been amended to include a new Rivet Tool, and Repair Bracket installation on the passenger side strut housing. Please discard all previous versions of this campaign bulletin.

CAMPAIGN ID #: R1109
 NHTSA #: 11V-244
 APPLIED VEHICLES: 1997- 2003 QX4 (JR50)

Check Service COMM to confirm campaign eligibility.

INTRODUCTION

Infiniti is conducting a voluntary safety recall campaign on certain model year 1997 – 2003 QX4 vehicles that are currently registered in States where heavy concentrations of road salt are used in the winter to inspect for corrosion, and if necessary repair the front strut housing panels.

Salt States

Maine, New Hampshire, Vermont, Massachusetts, Rhode Island, Connecticut, New York, New Jersey, Pennsylvania, Delaware, Maryland, West Virginia, Ohio, Indiana, Michigan, Illinois, Wisconsin, Minnesota, Iowa, and Missouri and the District of Columbia.

IDENTIFICATION NUMBER

Infiniti has assigned identification number R1109 to this campaign. This number must appear on all communications and documentation of any nature dealing with this campaign.

DEALER RESPONSIBILITY

It is the dealer's responsibility to check Service Comm for the campaign status on each vehicle falling within the range of this voluntary safety recall which for any reason enters the service department. This includes vehicles purchased from private parties or presented by transient (tourist) owners and vehicles in a dealer's inventory. **Federal law requires that new vehicles in dealer inventory which are the subject of a safety recall must be corrected prior to sale. Failure to do so can result in civil penalties by the National Highway Traffic Safety Administration.** While federal law applies only to new vehicles, Infiniti strongly encourages dealers to correct any used vehicles in their inventory before they are retailed.

TABLE OF CONTENTS

	Page
REPAIR OVERVIEW	3
REQUIRED SPECIAL TOOLS	4
SERVICE PROCEDURE	5
Determine if Vehicle is Repairable	5
Determine Repair Level (driver side AND passenger side)	9
Level 1 Repair (driver side AND passenger side)	11
Driver AND Passenger Side - Level 2 Repair.....	13
Strut Removal	13
Repair Bracket Installation	16
Patching Perforated Areas	35
STEERING SHAFT REPLACEMENT	42
EXAMPLE PHOTOS (perforation and scab corrosion).....	46
PARTS INFORMATION	48
CLAIMS INFORMATION	49
OWNER LETTER	53
NON REPAIRABLE REPORT	54

REPAIR OVERVIEW

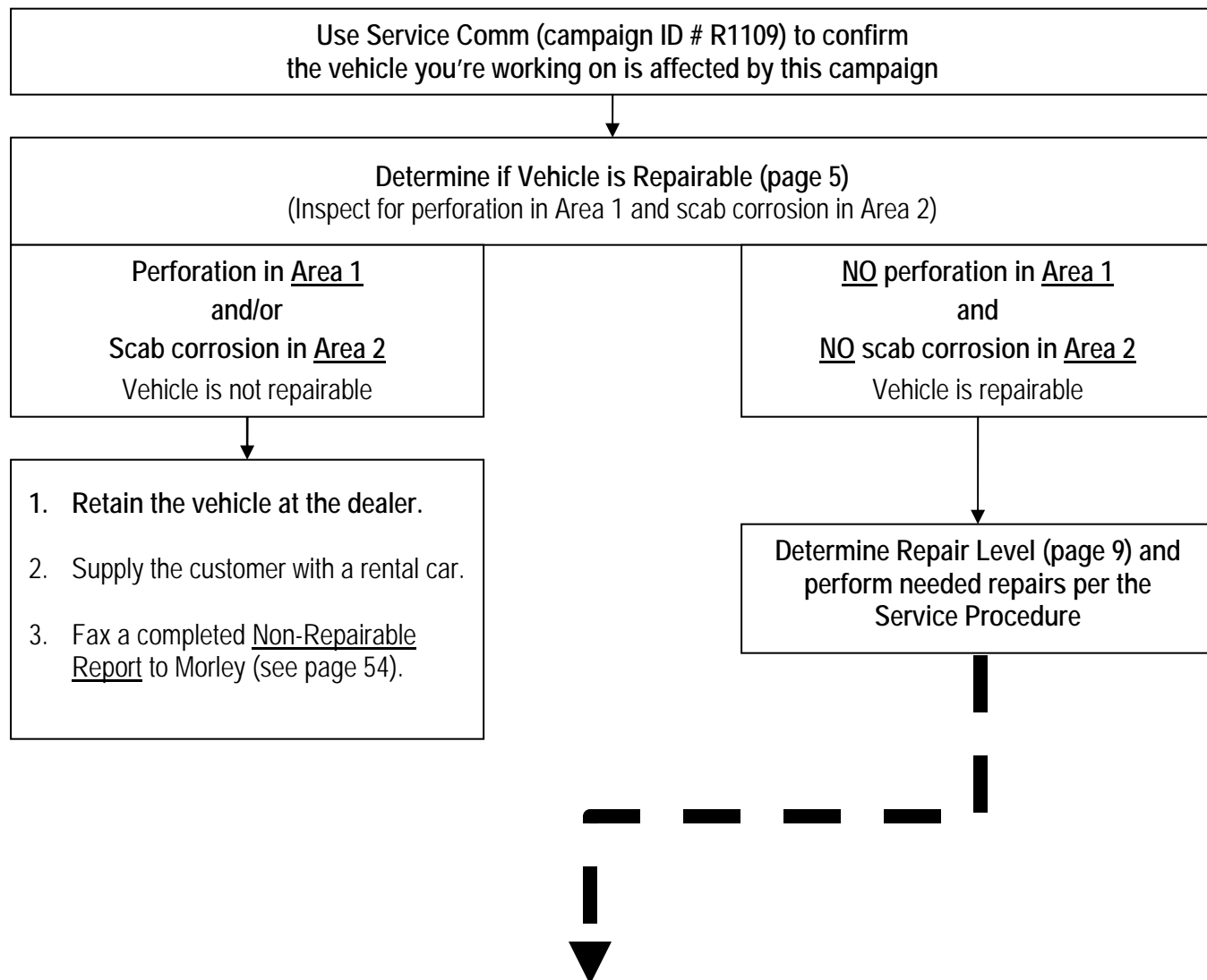

Possible Repair Levels

	Use Level 1 Repair If:	Use Level 2 Repair If:
Driver Side *	No visible rust or <u>only</u> surface rust (page 11)	Any scab corrosion or perforation (page 13)
Passenger Side *	No visible rust or <u>only</u> surface rust (page 11)	Any scab corrosion or perforation (page 13)

* Refer to summary of each repair level on page 10.

REQUIRED SPECIAL TOOLS

Ratchet Strap (J-50836)

- Each dealer will be shipped, at no charge, one Ratchet Strap.
- Additional tools can be ordered from TechMate at 1-800-662-2001.



Rivet Tool (J-50835)

- Each dealer will be shipped, at no charge, one Rivet Tool (includes high pressure lubricant).
- Additional tools can be ordered from TechMate at 1-800-662-2001.

CAUTION: DO NOT use power tools or impact tools with the Rivet Tool – use hand tools only.



2:1 Dispensing Gun (J-50816)

- This tool is used to dispense LORD Fusor® 108B (structural adhesive).
- Each dealer will be shipped, at no charge, one 2:1 Dispensing Gun.
- Additional tools can be ordered from TechMate at 1-800-662-2001.



1:1 Dispensing Gun (Caulking Gun)

- This tool is used to dispense LORD Fusor® 800EZ (seam sealer).
- Caulking guns are commonly used for application of other automotive products. Each dealer should already have a caulking gun as a shop tool.



33/64 Drill Bit (J-50878)

- Each dealer will be shipped, at no charge, one 33/64 Drill Bit.
- Additional tools can be ordered from TechMate at 1-800-662-2001.

SERVICE PROCEDURE

NOTE: This campaign does not cover any repairs beyond those specifically mentioned in this Service Procedure.

1. Lift the vehicle on a hoist.
2. Remove both front wheels.

Determine if Vehicle is Repairable (driver AND passenger side inspection)

3. Inspect for corrosion on the driver side AND passenger side in the wheel house Area 1 and strut housing Area 2 (see Figures 1, 2, 3, and 4).

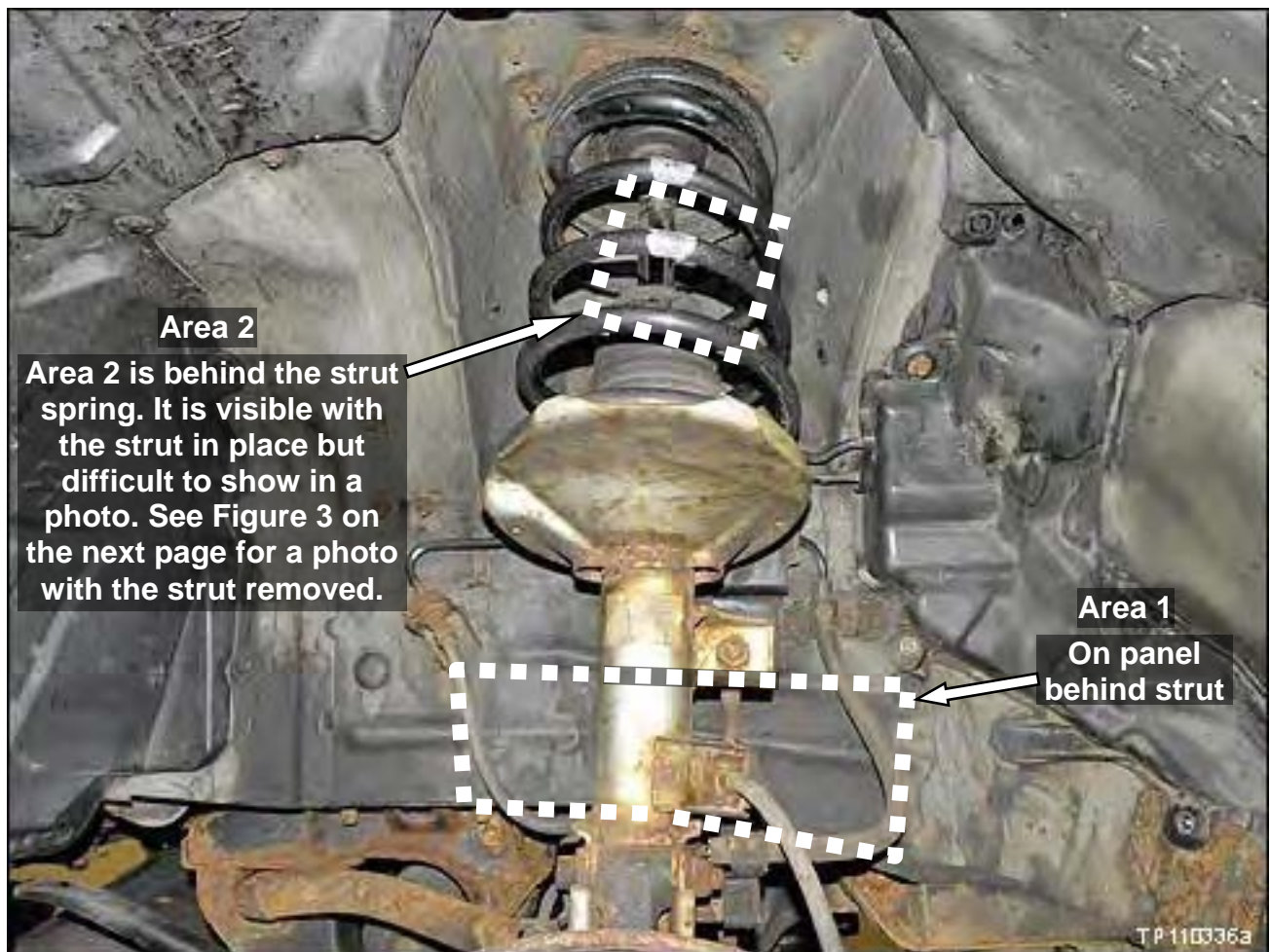

Figure 1

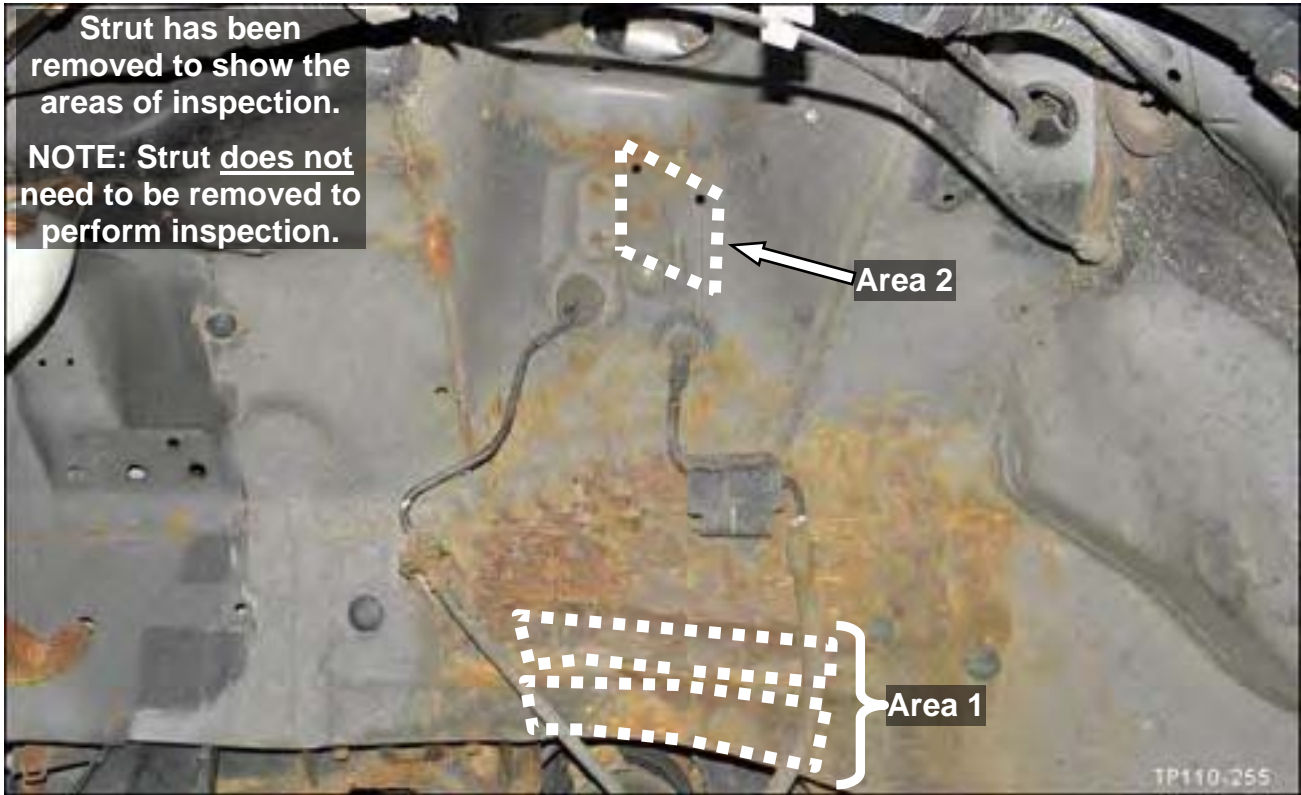

Figure 2

This example photo shows the inspection areas in relation to the repair bracket installation.

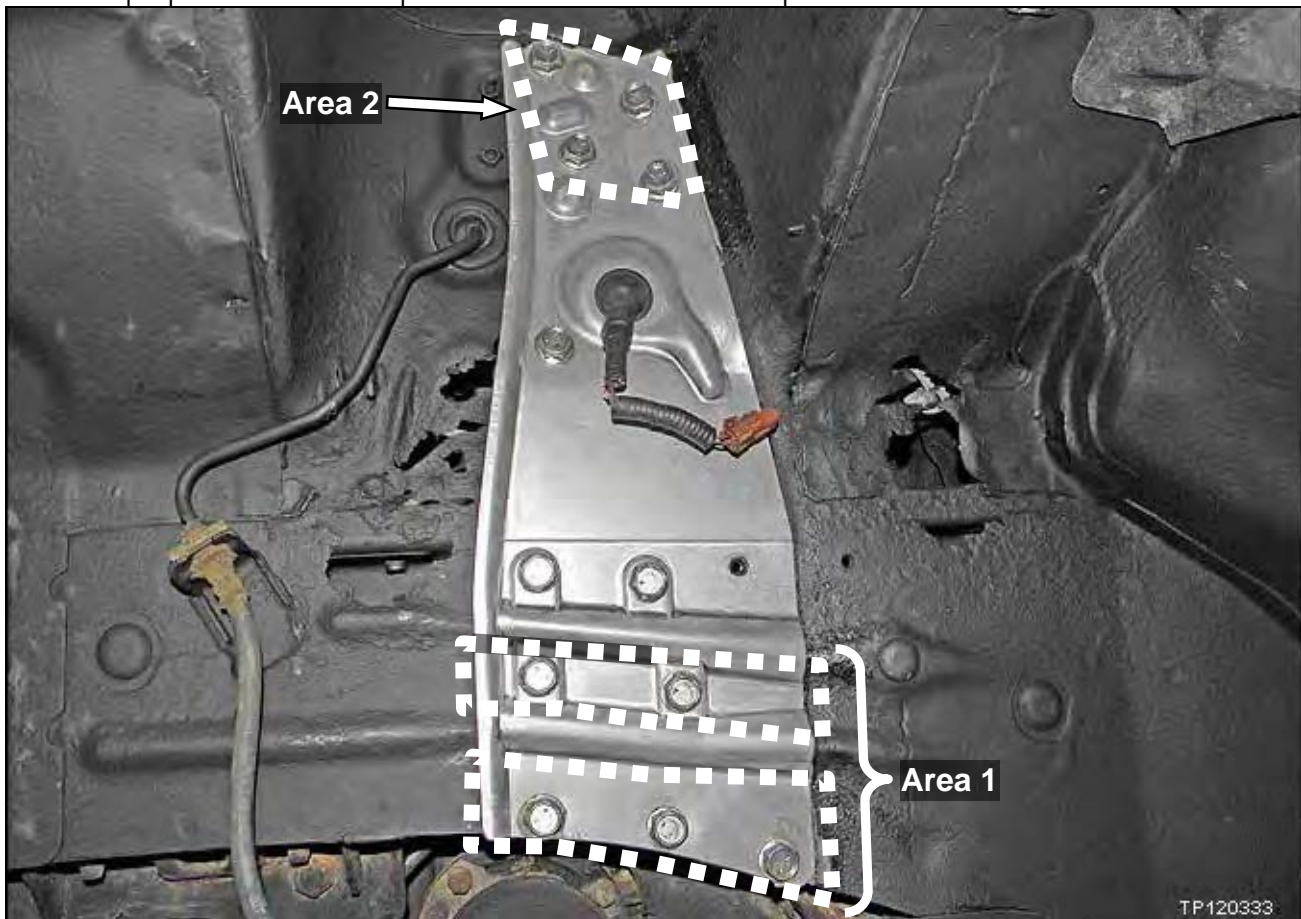

Figure 2A

Area 1

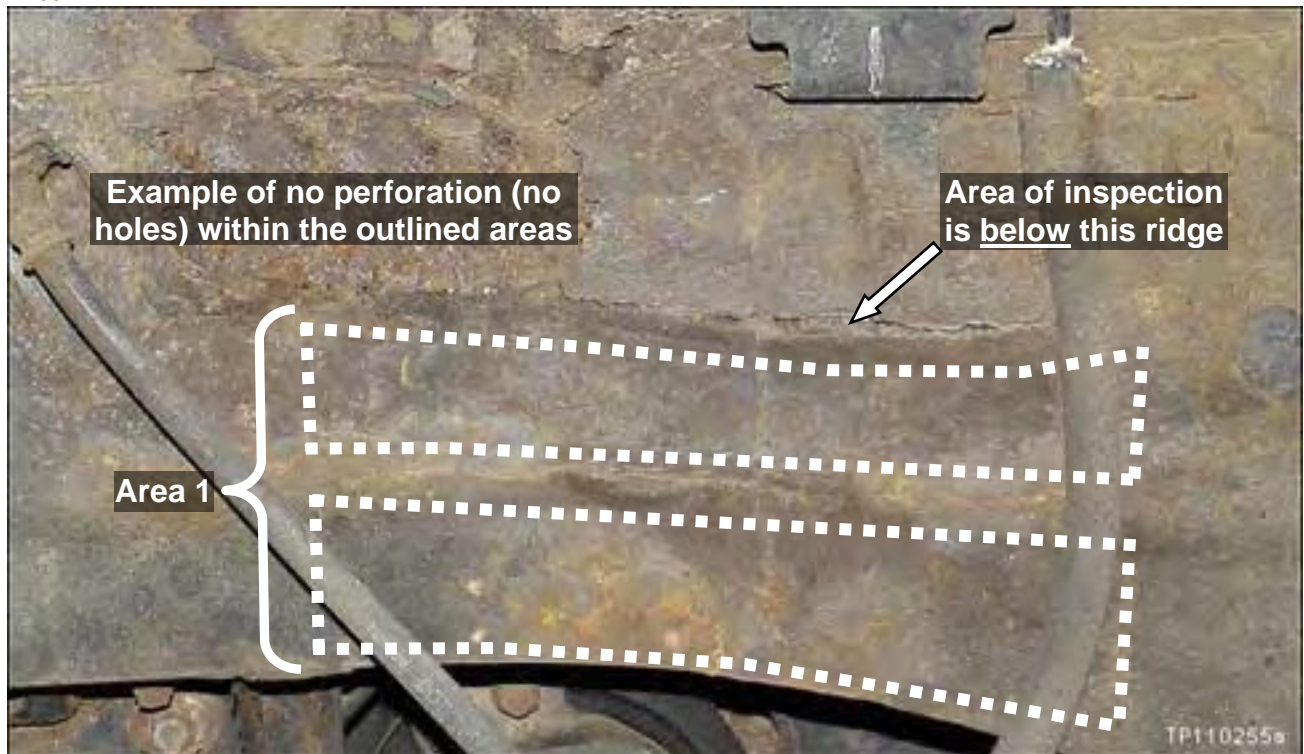

Figure 3

Area 1: Look for perforation (holes) in the metal only in the areas outlined above.

NOTE:

- The area shown in Figure 3 applies to driver side **AND** passenger side.
- If needed, refer to examples (additional photos) of Area 1 perforation inspection on pages 46 and 47.

If there is **perforation** (holes) in the metal in Area 1, driver side **OR** passenger side:

- a. Retain the vehicle at the dealer. (The vehicle is not repairable.)
- b. Supply the customer with a rental car.
- c. Fax a completed Non-Repairable Report to Morley (see page 54).

If there is **no perforation** (no holes) in the metal in Area 1, driver side **OR** passenger side:

- Go to Area 2 on the next page.

Area 2

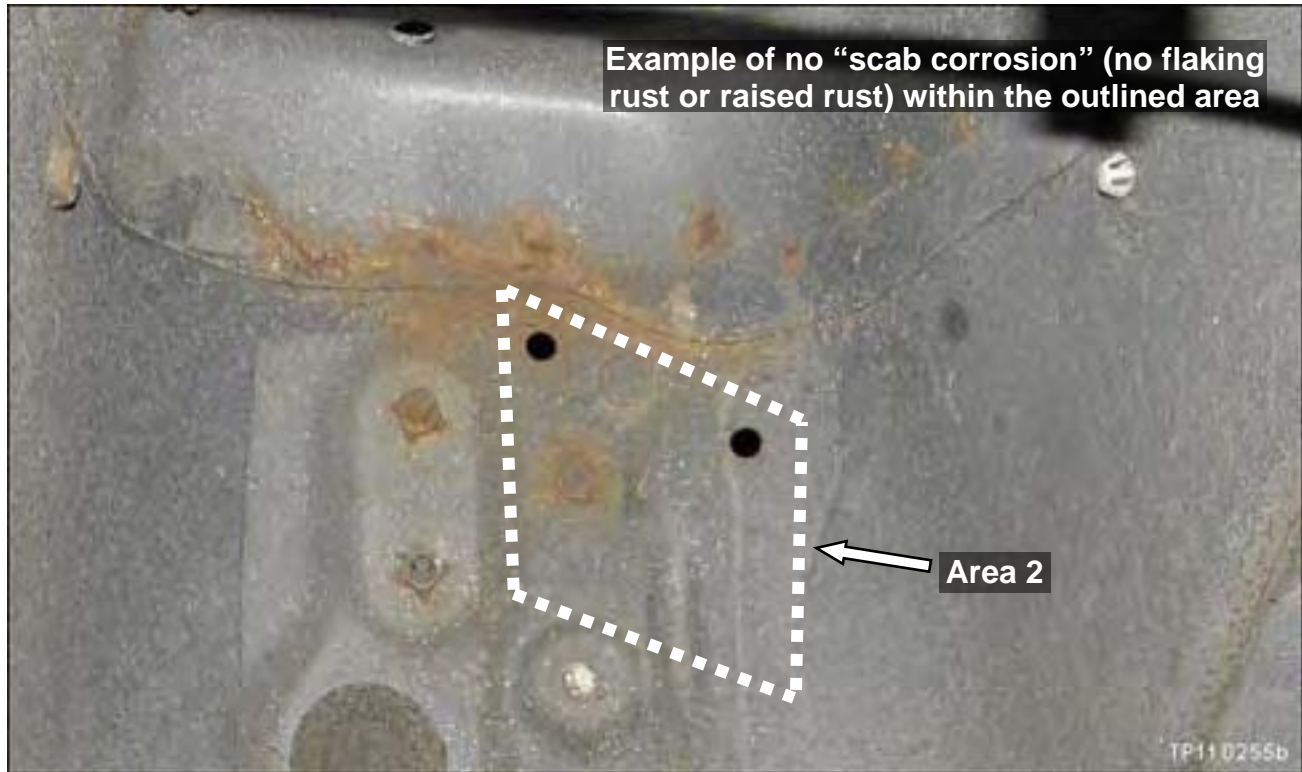

Figure 4

Area 2: Look for "scab corrosion" (flaking rust or raised rust) on driver side **AND** passenger side only in the area outlined above.

NOTE:

- The area shown in Figure 4 applies to driver side **AND** passenger side.
- If needed, refer to examples (additional photos) of Area 2 scab corrosion inspection on page 47.

Figure 5 is an example of "scab corrosion" (flaking and raised rust).



Figure 5

If there is **scab corrosion** (flaking or raised rust) in Area 2, driver side **OR** passenger side:

- a. Retain the vehicle at the dealer. (The vehicle is not repairable.)
- b. Supply the customer with a rental car.
- c. Fax a completed Non-Repairable Report to Morley (see page 54).

If there is **no scab corrosion** (no flaking or raised rust) in Area 2, driver side **OR** passenger side:

- Go to Determine Repair Level on the next page.

NOTE: If there is no perforation in Area 1 and no scab corrosion in Area 2 on the driver side OR passenger side, the vehicle is repairable.

Determine Repair Level (driver side AND passenger side)

NOTE: At this point in the procedure the vehicle should have been deemed "repairable". If needed, refer to Determine if Vehicle is Repairable on page 5.

1. Use mild soap, water, and a brush to **thoroughly wash** the strut housing and the wheel housing in the area shown in Figure 6 (**both sides**).

NOTE: Passenger side is shown, driver side is similar.



Figure 6

2. Visually inspect for corrosion and rust on the wheel housing panel and the strut housing panel (driver and passenger side).
 - Inspect for corrosion and rust on the panels only.

NOTE: Corrosion and rust on the strut or other suspension components is not covered by this campaign.

Possible Repair Levels

NOTE: Repair levels for driver side and passenger side are to be determined independently.

	Use Level 1 Repair If:	Use Level 2 Repair If:
Driver Side *	No visible rust or <u>only</u> surface rust (page 11)	Any scab corrosion or perforation (page 13)
Passenger Side *	No visible rust or <u>only</u> surface rust (page 11)	Any scab corrosion or perforation (page 13)

* Refer to summary of each repair level on the next page.

Summary of Repair Levels

NOTE: Repair levels for driver side and passenger side are to be determined independently.

Driver Side AND Passenger Side

Level 1 – No visible rust or only surface rust

- Use an abrasive tool to remove surface rust
- Clean wheel housing and strut housing area
- Apply self etching primer
- Apply rubberized undercoating

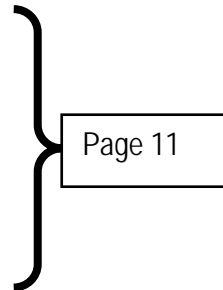

Level 2 – Any scab corrosion or perforation

- Remove the strut
- Use an abrasive tool to remove loose corrosion and rust
- Apply self etching primer
- Install the repair bracket
- Patch perforated areas – if needed
- Apply rubberized undercoating

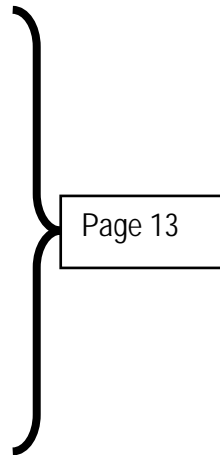

LEVEL 1 REPAIR (driver side AND passenger side)

For driver side AND passenger side - no visible rust or only surface rust

WARNING: Perform repairs in a well ventilated area.

NOTE:

- Plastic covers (fender protectors) in the wheel house area do not need to be removed.
- Photos in this section are of the passenger side, driver side is similar.
- For 4WD vehicles: If the drive shaft boot is ripped, it should be covered to prevent debris from entering the drive shaft joint.

1. Use a wire brush to remove loose rust in the area shown with dashed line.



Figure 7

2. Clean dust, dirt, or other debris from the wheel housing and strut housing area.

3. Cover the strut so it is protected from overspray.

4. Completely and liberally coat the strut housing and wheel house area with self etching primer.

- Use DuPont Etch Primer (P/N A-4119S™) or equivalent.
- Follow all product instructions.
- Coat all of the exposed metal areas on the strut housing and wheel house panels.

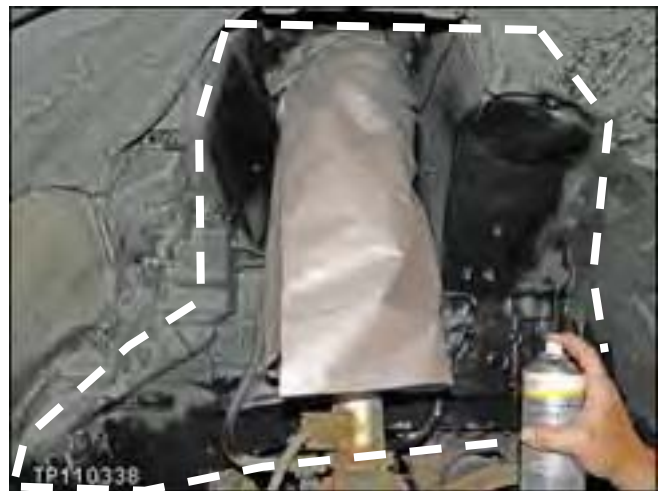

Figure 8

- A second coat may be needed for heavy rust spots.
- Let each coat dry for 5 minutes.

NOTE: Refer to the Parts Information for additional product details.

5. Completely and liberally coat the wheel house and strut housing area with rubberized undercoat.

- Use 3M™ Rubberized Undercoating (P/N 051135 – 08883) or equivalent.
- Follow all product instructions.
- Coat all of the exposed metal areas on the strut housing and wheel house panels.
- Use a spray nozzle to spray the areas behind the strut and other hard to reach areas.

NOTE: Refer to the Parts Information for additional product details.

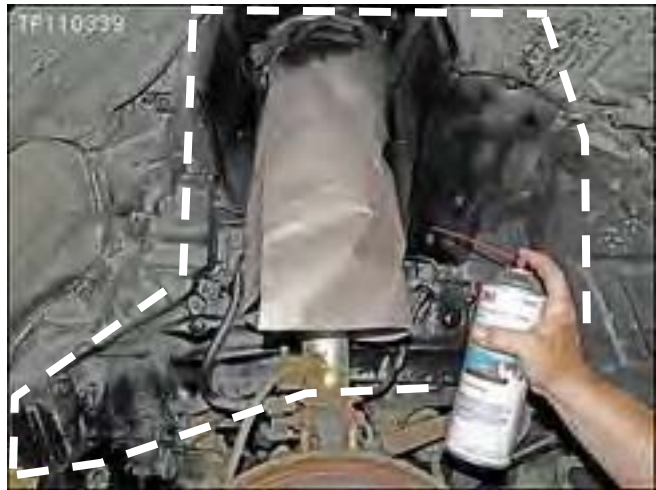

Figure 9

6. Let the undercoat dry for about 1 hour before removing the strut cover.

7. Reinstall the wheel.

- Torque wheel nuts to 118 – 147 N•m (12 – 15 kg-m, 87 – 108 ft-lb).

NOTE: Do not wash the vehicle for 24 hours. This will allow the undercoat to cure completely before exposure to water.

LEVEL 2 REPAIR – DRIVER SIDE AND PASSENGER SIDE

NOTE: The front strut removal procedure is the same on the driver side **AND** passenger side, unless stated otherwise.

Front Strut Removal

NOTE:

- Use care during strut removal to prevent stress on electrical, hydraulic, and mechanical components.
- If needed; spray the strut mounting bolts/nuts with Nissan Rust Penetrant (P/N 999MP-A3020P) or equivalent.

1. Support the transverse link (lower control arm) with a jack stand as shown.
 - a. Position the jack stand under the lower control arm.
 - b. Lower the vehicle until the lower control arm touches the jack stand.

NOTE: Do not lower the vehicle beyond just touching the jack stand. Do not put tension on the coil spring.



Figure SR1

2. Disconnect the following items:
 - Remove clip and take the brake hydraulic line loose from its support.
 - Discard the clip, use new clip for reassembly.
 - Remove the bolt for ABS sensor harness support.
 - Take the ABS sensor harness loose from support on the other side of strut (not shown).
 - Remove the lower strut bolts.
 - Discard the nuts, use new ones for reassembly.

NOTE: Do not remove the nuts from the stabilizer connecting rod.

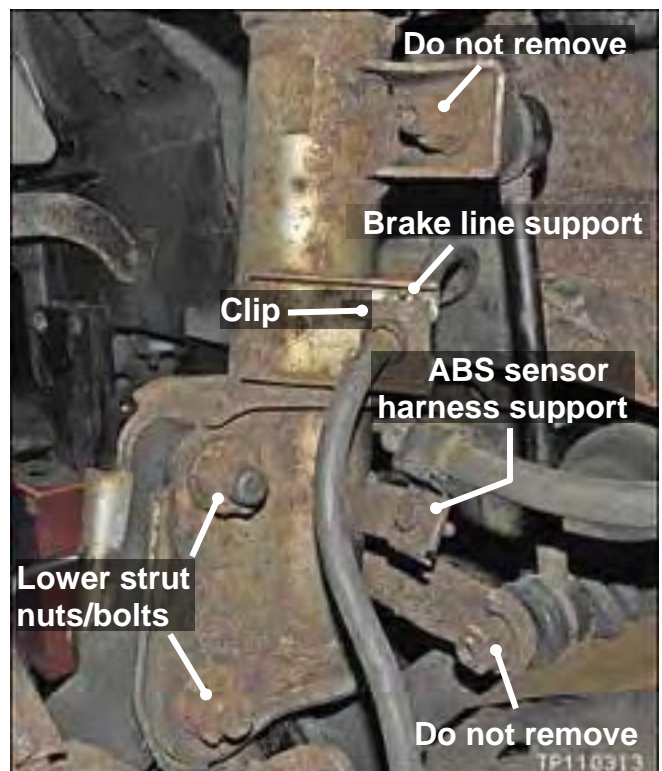

Figure SR2

3. **Carefully** separate the knuckle from the strut.

NOTE: Do not let the knuckle fall away from the strut. This will cause the weight of the knuckle assembly to pull on the brake line and the driveshaft boot (if equipped).

4. Use an elastic strap or other suitable tool to secure the knuckle to the stabilizer bar as shown.

NOTE: Make sure the knuckle assembly is secure. Its weight must be supported during the entire repair process.

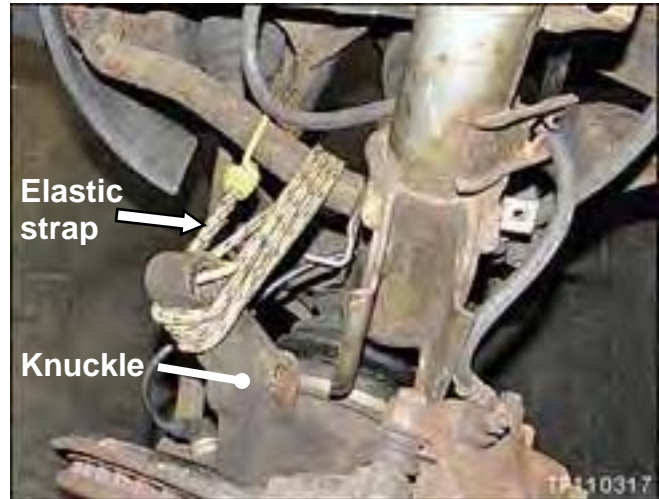

Figure SR3

5. Remove the 2 bolts for the ABS sensor connector cover.



Figure SR4

6. Disconnect the ABS sensor connector.

- ABS sensor connector is on the back side of the cover.



Figure SR5

7. Pull the ABS sensor harness from behind the strut.
8. Let the ABS sensor harness hang out of the way as shown.



Figure SR6

9. Raise the vehicle enough so the lower control arm is not touching the jack stand.

10. Remove the 3 upper strut mounting nuts.
 - Discard the nuts, use new ones for reassembly.

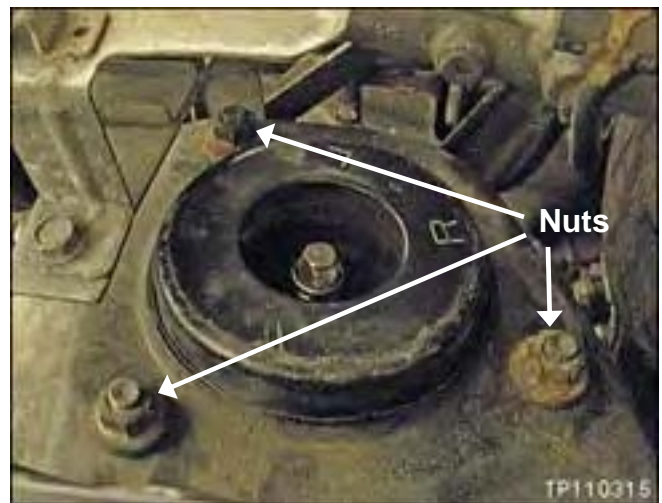

Figure SR7

11. Maneuver the strut so it is hanging upside down as shown.

NOTE: The weight of strut is supported by the stabilizer connecting rod.

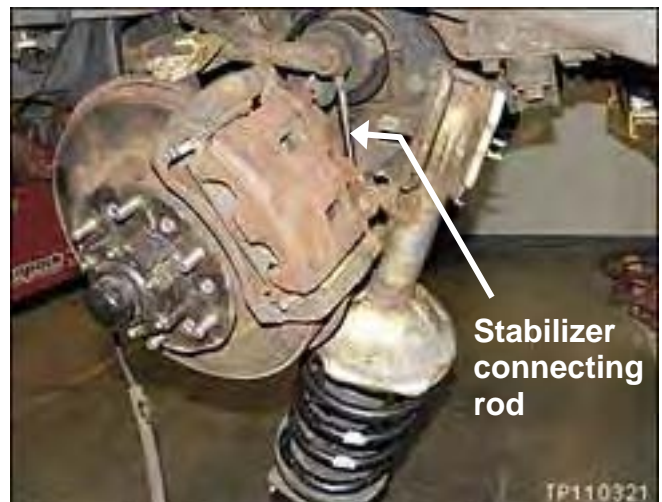

Figure SR8

Repair Bracket Installation for Driver Side AND Passenger Side Strut Housing (Level 2 repair continued)

NOTE: The repair bracket installation procedure is the same on both sides, unless stated otherwise.

WARNING: Perform repairs in a well ventilated area.

NOTE: For 4WD vehicles: If the driveshaft boot is ripped, it should be covered to prevent debris from entering the driveshaft joint.

1. Inspect the ABS sensor harness for damage. If damaged, repair as necessary.
2. Push the ABS harness and connector through the panel.
 - The harness/connector will now be out of the working area.



Figure RB1

3. Use a scraper bar to scrape off loose flaking rust and corrosion.



Figure RB2

4. Clean all the loose rust from the strut housing and wheel house areas (see Figure RB3).

- Use an abrasive pad or other suitable tool.

CAUTION: Avoid contacting the brake line(s) with your abrasive tool.

NOTE: If the brake line is in the way of an area that needs cleaning, move it out of the way by first removing the clip from the mount.



Figure RB3

4a. Passenger side: work around the 2 brake lines and junction block best as possible (see Figure RB4).

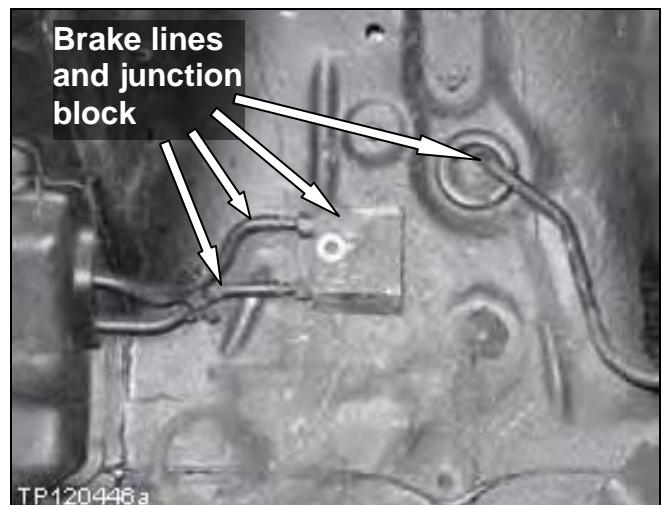

Figure RB4

NOTE: Steps 5 and 6 apply to Driver side only.

5. **From under the hood**, remove the air filter box and the air intake duct between the filter box and the engine.

6. Inspect the steering column upper joint (steering shaft) in the area circled in Figure RB5.

Check for rubbing/contact with the strut housing panel.

Contact may have occurred if the strut housing separated from the wheel house.

- **ONLY if the E-coat has been rubbed through to bare metal**, the steering shaft will need to be replaced.
- If the steering shaft needs replacement, you will be instructed to replace it later in this procedure.



Figure RB5

7. Passenger side – as needed: Remove the battery, Relay Box-2, etc, to access the strut tower for inspection of separation.

7a. Only if the strut housing panel is separated as shown in Figure RB6:

Use a wire brush to clean any loose rust, paint, or other debris from the area shown with dashed line.



Figure RB6

8. Use low pressure compressed air to blow off dust and debris:
 - From the under hood side of the strut housing panel and the surrounding area, and
 - From the wheel house area.

9. Use isopropyl alcohol to clean/wipe down the area:
 - If the strut housing panel was separated, clean/wipe down the under hood side of the strut housing panel and the surrounding area.
 - Clean/wipe down the wheel house area.

10. Only if the strut housing panel is separated:

Completely and liberally coat the strut housing panel (in the area shown with dashed line) with self etching primer.

- Use DuPont Etch Primer (P/N A-4119S™) or equivalent.
- Follow all product instructions.
- A second coat may be needed for heavy rust spots.
- Let each coat dry for 5 minutes.

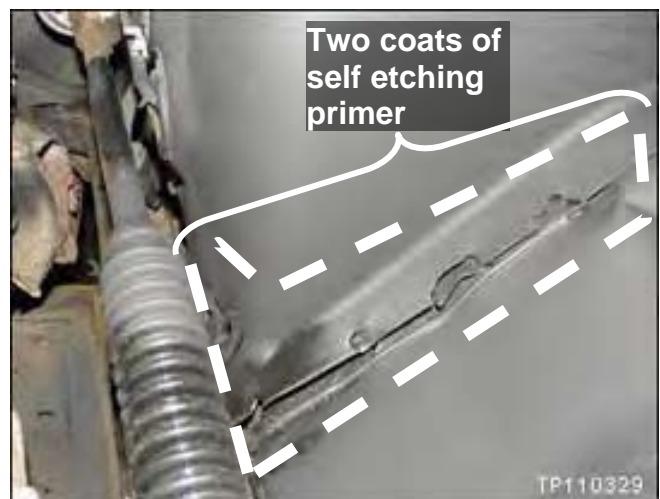

Figure RB7

NOTE: Refer to the Parts Information for additional product details.

11. Completely and liberally coat the strut housing and wheel house area with self etching primer.

- Use DuPont Etch Primer (P/N A-4119S™) or equivalent.
- Follow all product instructions.
- Coat all of the exposed metal areas on the strut housing and wheel house panels.
- A second coat may be needed for heavy rust spots.
- Let each coat dry for 5 minutes.

NOTE: Refer to the Parts Information for additional product details.



Driver side

Figure RB8

Passenger side

12. Driver side: Locate the 2 existing holes at the upper area of the strut housing panel (see Figure RB8a).

- With a drill bit, enlarge the 2 existing holes to 10 mm (3/8 in).

13. Passenger side: Locate the one existing hole at the upper area of the strut housing panel (see Figure RB8a).

- With a drill bit, enlarge the one existing hole to 10 mm (3/8 in).

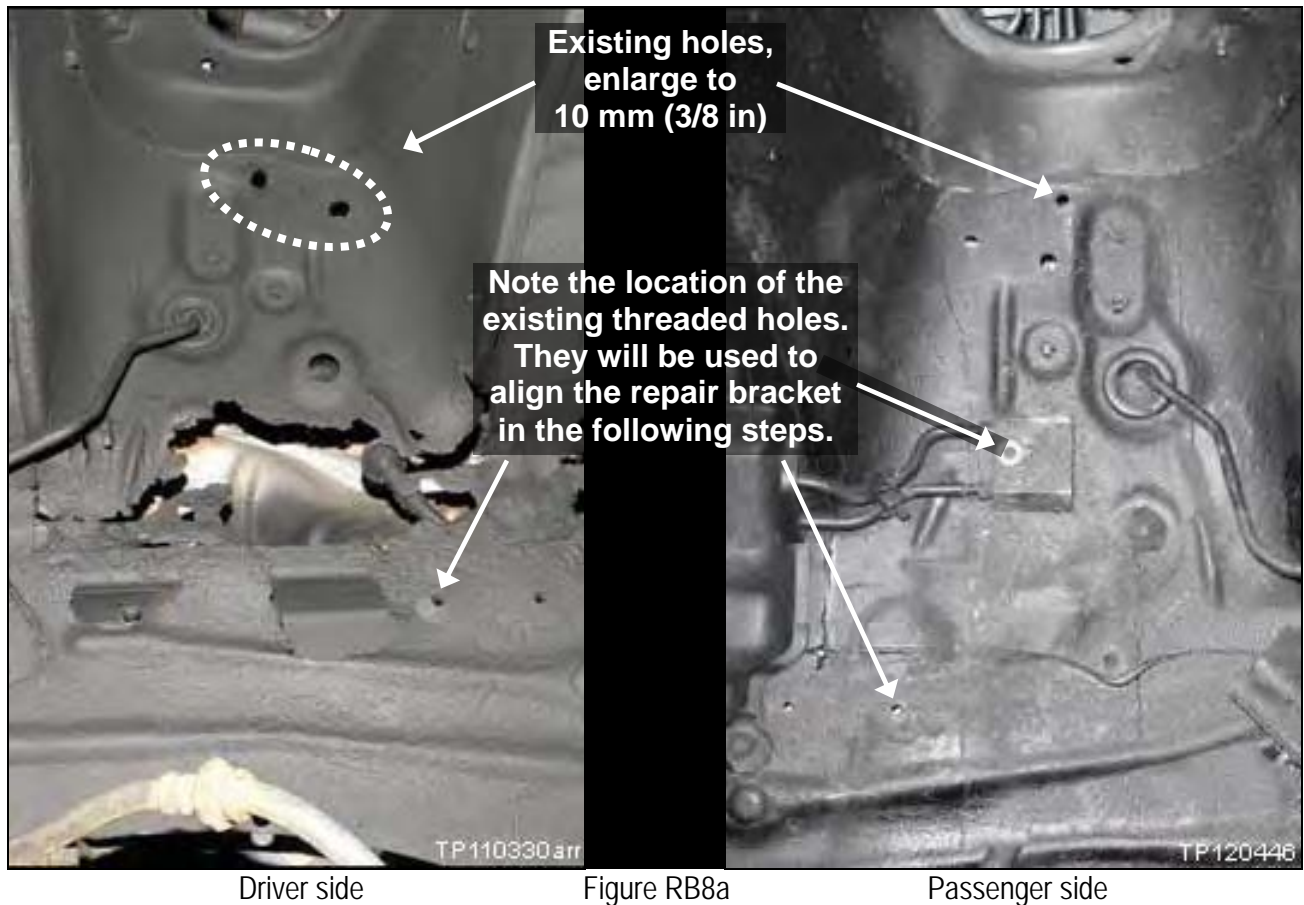

14. Attach the repair bracket using the existing holes that you enlarged (see RB9).

- The repair bracket is part of the Repair Kit listed in the Parts Information.
- Use bolts and hex nuts from the Repair Kit.
- Also use the existing bolt(s) where shown in RB9.
- Tighten the bolts/nuts finger tight.

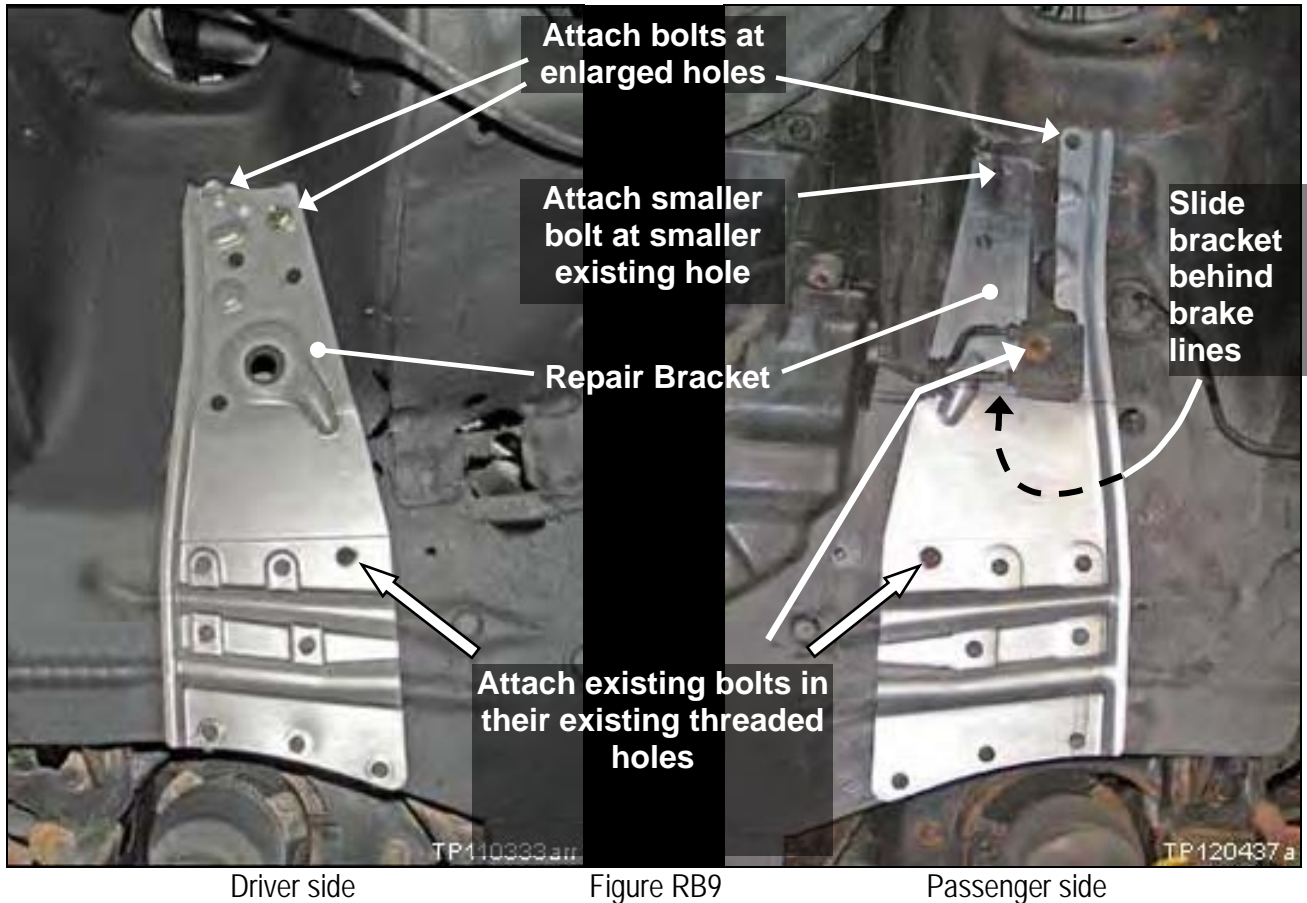

15. Only if the strut housing panel is separated:

- a. Attach the ratchet strap as shown in Figure RB10.
- b. Use the ratchet strap to pull the strut housing panel down until the existing threaded hole(s) is aligned with the matching hole in the repair bracket (see Figure RB10).

16. Install all bolts as shown in Figure RB10, and make them finger tight.

17. Align the bottom edge of the repair bracket with the edge of the body frame.

- The bracket will have some movement in all directions. Move it (align it) the best possible.

18. Once the bottom edge is aligned, securely tighten all bolts (see Figure RB10).

- At this time, a pair of locking pliers or equivalent tool may be used to further support the repair bracket (see Figure RB10).
- Bolts need to be tight enough to hold the bracket in place while center punching and drilling holes in the next step.

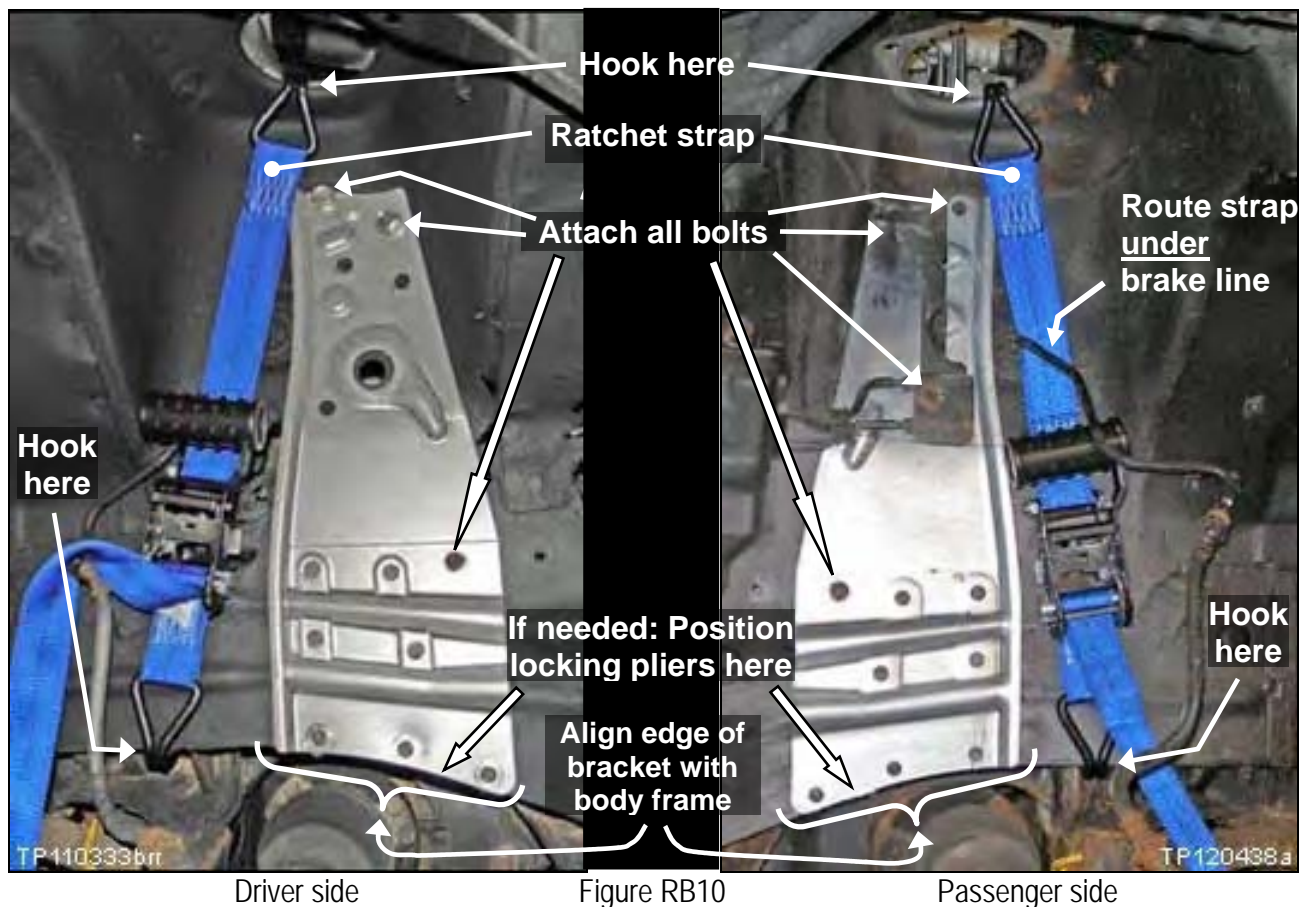

NOTE: Photos for installation of the repair bracket show the ratchet strap being used. In most cases, the strut housing panel will not be separated and the ratchet strap will not be needed.

19. Drill the holes shown by white arrows in Figure RB11 to **10 mm (3/8 in)**:

- a. Center punch the holes.
- b. Pilot drill with a 1/8 drill bit.
- c. Drill holes to **10 mm (3/8 in)**.

20. Passenger side: Draw a white line as shown in RB11.

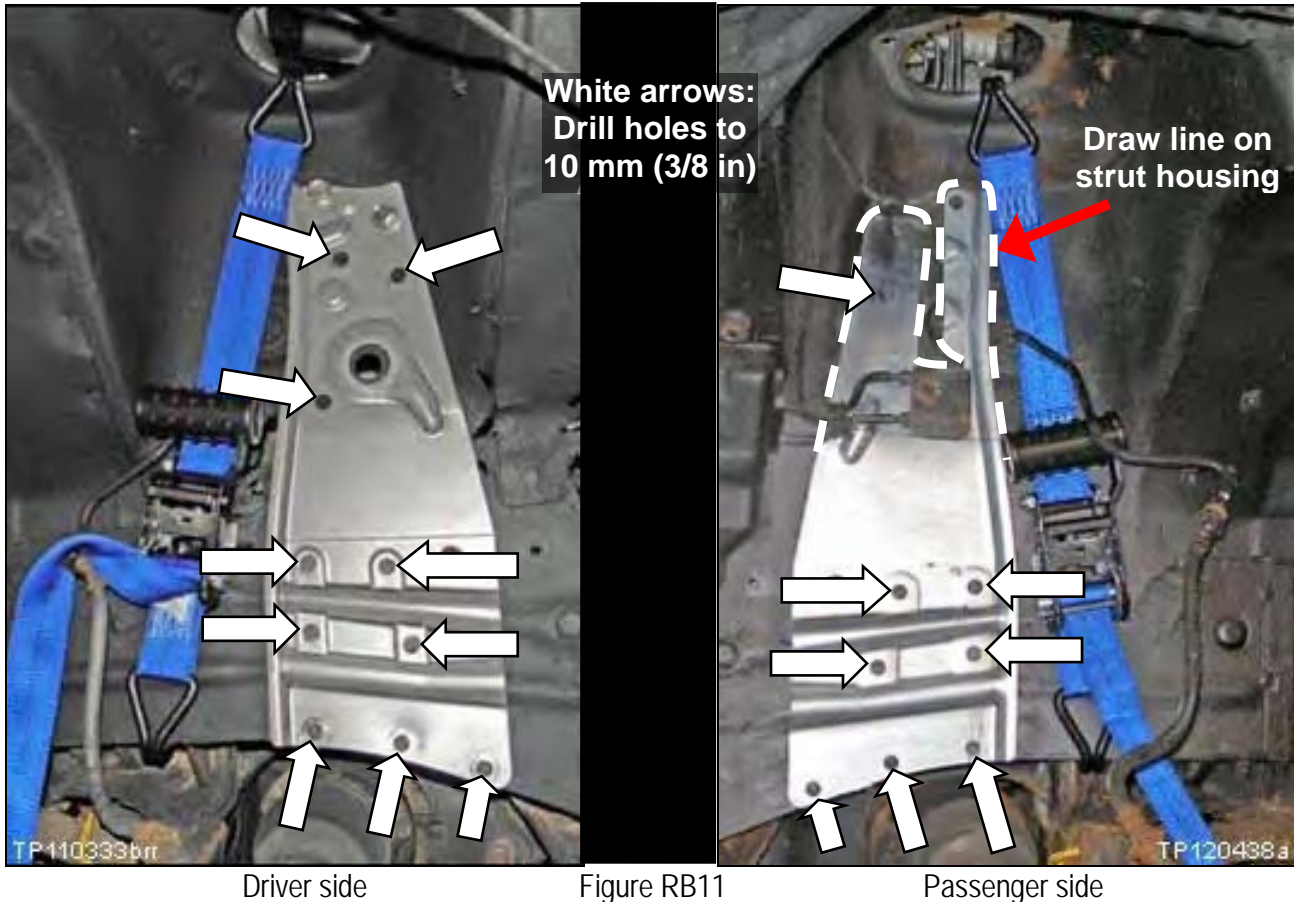

21. When drilling is done, remove the repair bracket.

22. For the 4 holes that will have Rivet Nuts installed, drill final hole size to 13.1 mm (33/64 in). See Figure RB12.

NOTE: Each dealer was shipped, at no charge, one 33/64 drill bit (J-50878).

23. Install Rivet Nuts in the 13.1 mm (33/64 in) holes.

- Refer to Rivet Nut Installation Instructions on the next page.

CAUTION: DO NOT use power tools or impact tools with the Rivet Tool – use hand tools only.

IMPORTANT:

- **Lower holes - Required:** Rivet Nuts are required in the lower holes (indicated with dashed line in Figure RB12).

If the metal in the area of the lower holes will not support the rivet nuts, then the vehicle is “not repairable”: Retain the vehicle at the dealer, supply the customer with a rental car, and Fax a completed Non-Repairable Report to Morley (see page 54).

NOTE: Upper holes – not required: If the metal in the area of the upper holes will not support rivet nuts, continue with the repair. Rivet nuts are preferred but not required in the upper holes.

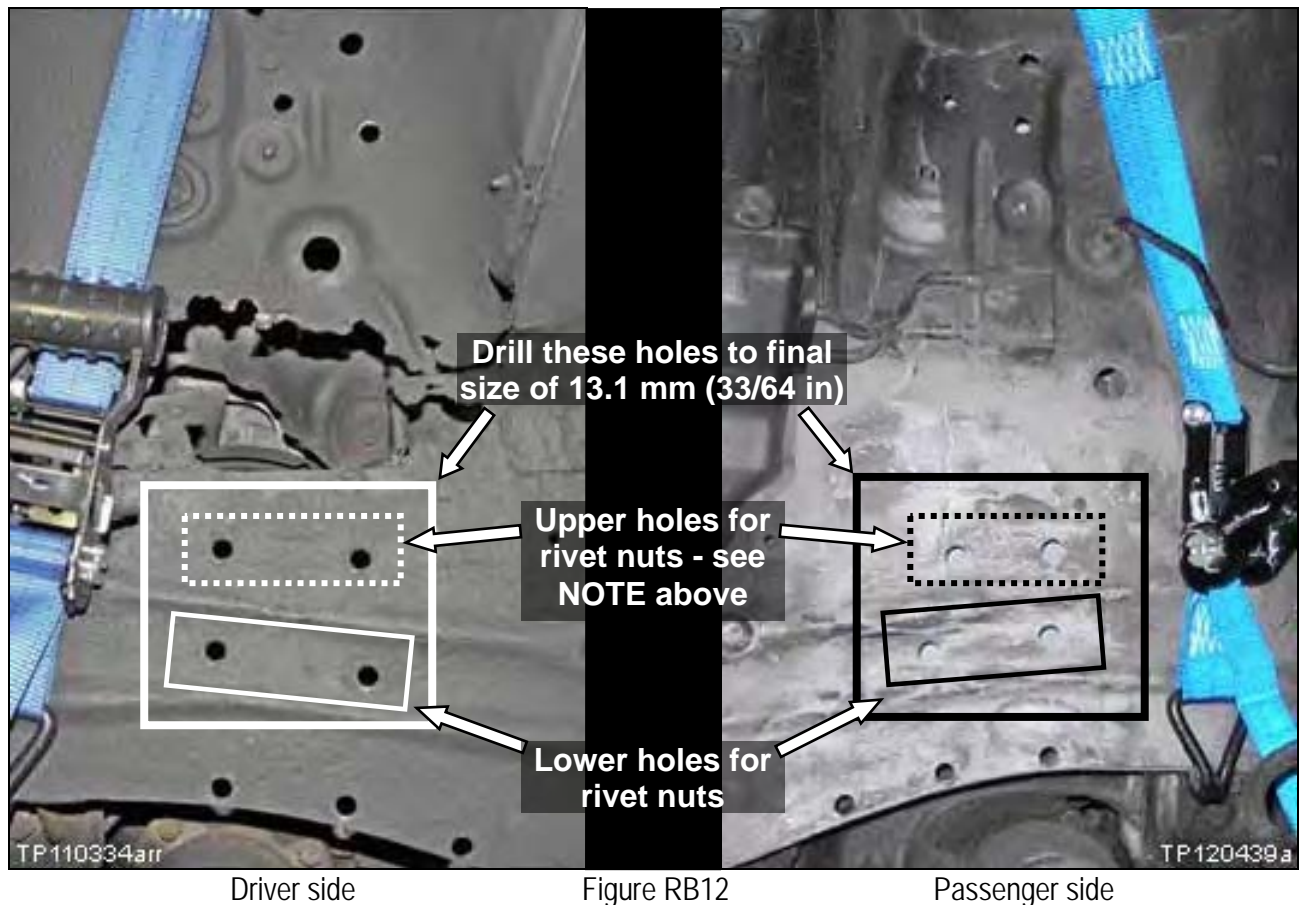

Rivet Nut Installation Instructions

CAUTION: DO NOT use power tools or impact tools with the Rivet Tool – use hand tools only.

NOTE: Rivet Tool J-50835 comes with extreme pressure lubricant. Apply to the threads and contact points of part #2 and part #3 for approximately every 60 rivet nuts installed (enough for 15 brackets).

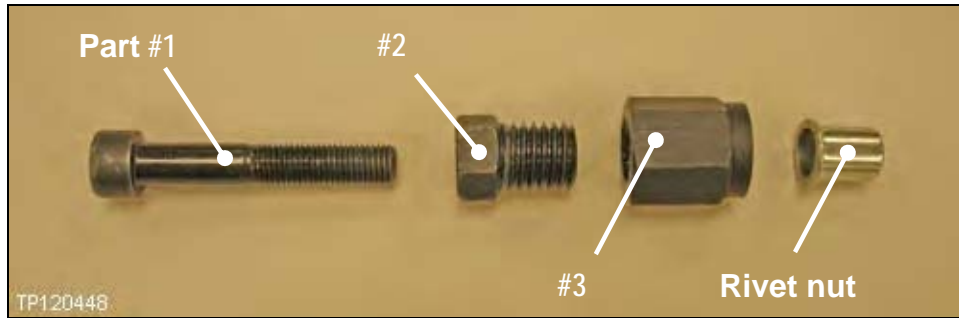

RB13 – Rivet Tool

1. Thread no more than finger tight part #2 into part #3 until it bottoms out (see Figure RB14).
 - This is a left handed thread.
2. Insert part #1 through part #2 and part #3 (see Figure RB15).



Figure RB14

Figure RB15

3. Thread a rivet nut onto part #1 until it bottoms out no more than finger tight (see Figure RB16).



Figure RB16

4. Insert the rivet nut into the 13.1 mm (33/64 in) hole until it bottoms out on its collar.

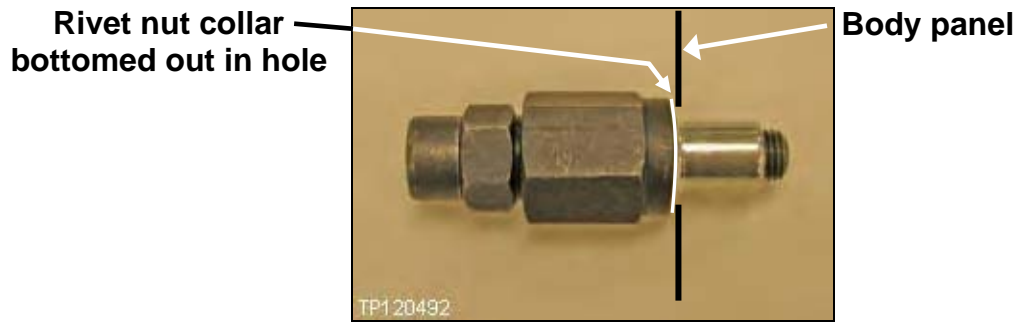

Figure RB17

5. Install the rivet nut by performing the following:
- Hold the rivet nut and tool against the body panel with moderate pressure.
 - Hold stationary part #3 while turning part #2 clockwise.
 - Turn part #2 approximately 2 turns or until turning resistance increases.
 - At this point, the rivet nut is installed.



Figure RB18

- d. Un-thread part #1 from the rivet nut.

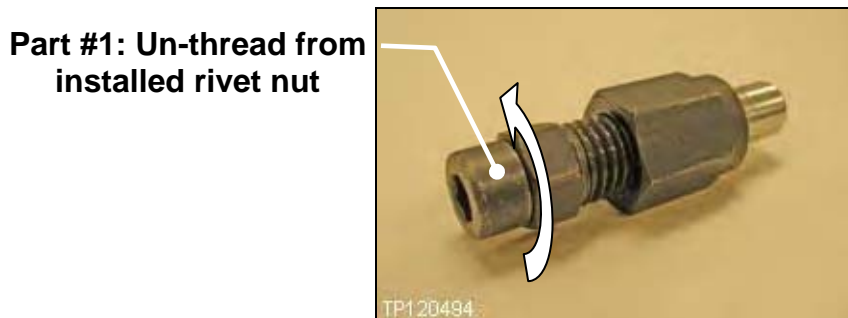

Figure RB19

- e. Perform steps 1 – 5d to install the remaining 3 rivet nuts.

24. Reinstall the ABS sensor harness in its hole.
- Make sure the rubber grommet is in place.

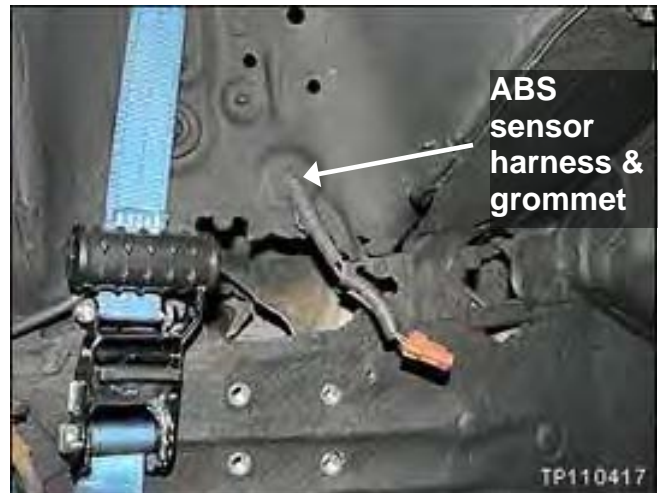

Figure RB20

25. Prepare for application of LORD Fusor® 108B (P/N 999MP – 108BP) structural adhesive (see Figure RB21 and RB22).
- a. Load cartridge of Fusor® 108B into the 2:1 dispensing gun.
 - b. Remove the cartridge cap and plugs (if this is the second use, remove the old nozzle).
 - c. Dispense/expel some material to make sure any hardened material is removed.
 - d. Install a new mixing nozzle onto the cartridge.
 - Make sure the nozzle retainer is installed (see Figure RB21).

NOTE:

- Mixing nozzles are one-time use only. Do not reuse mixing nozzles.
- Two mixing nozzles are included with each cartridge of Fusor® 108B.
- Refer to the Parts Information for additional product details.
- For cleanliness, using rubber gloves is recommended.

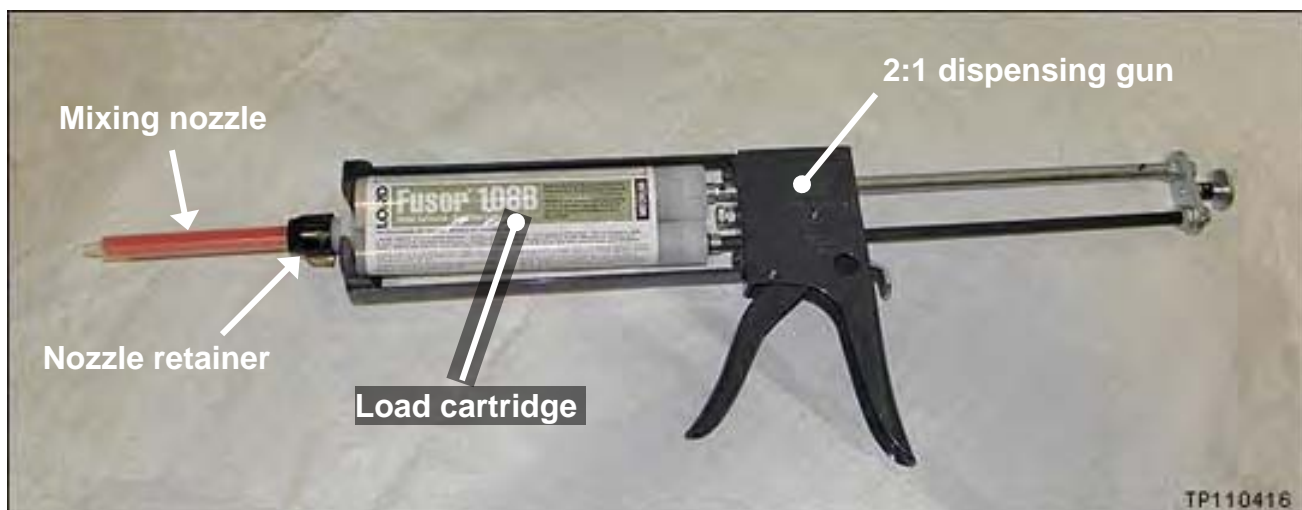

Figure RB21

e. Dispense 2 beads of Fusor® 108B onto a paper that will be discarded.

- Each bead should be about ¼ inch diameter and about 6 inches long (length of the nozzle).

NOTE: Performing this action will ensure the dispenser plungers have leveled, air bubbles have been expelled, and adhesive is mixed correctly.



Figure RB22

26. Liberally apply Fusor® 108B to the back side of the repair bracket as shown.

- The adhesive bead should be about ¼ inch diameter in all the areas shown.

NOTE: Filling the two channels with 3 beads will ensure good adhesion in the channel area.

- It is recommended to install one repair bracket at a time after applying Fusor® 108B.

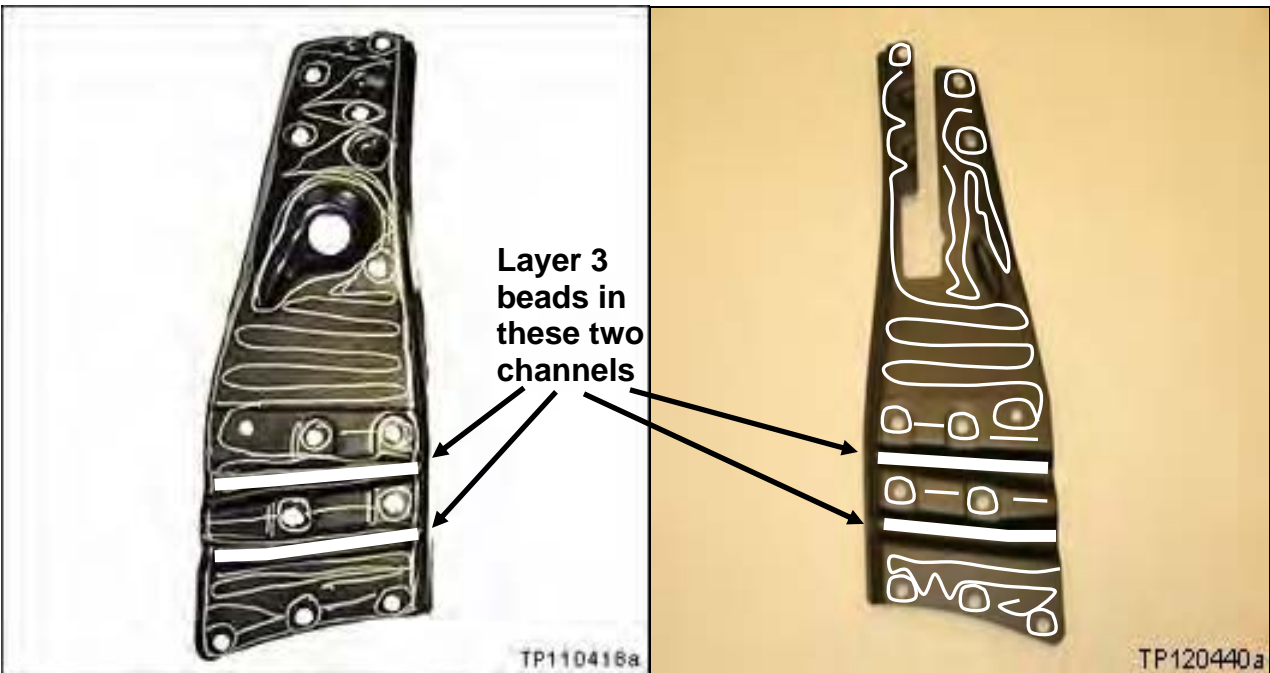
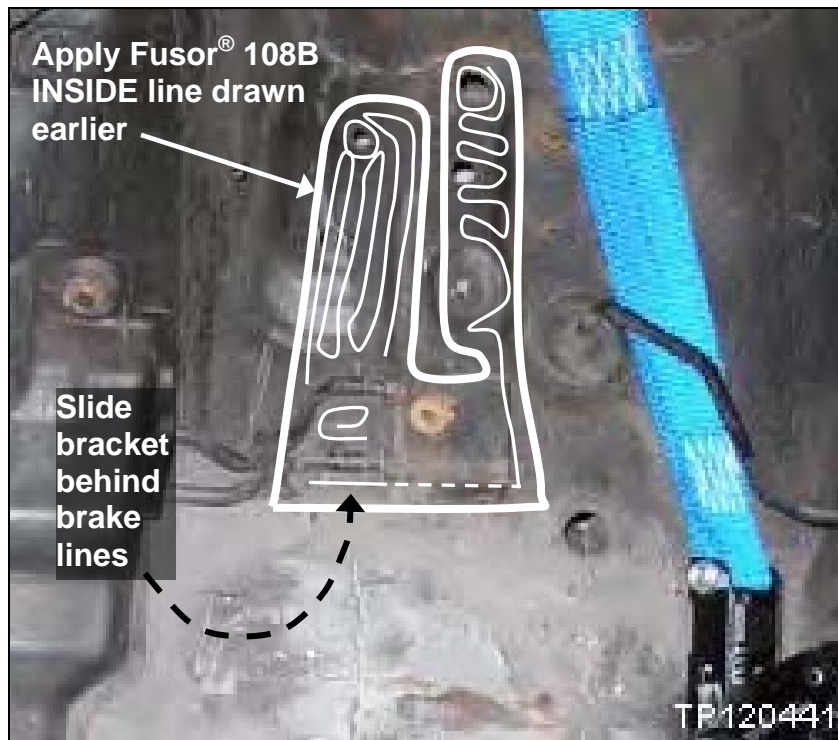

Figure RB23

NOTE:

- Each cartridge of Fusor® 108B has enough material to install two repair brackets.
- Leave the nozzle attached to the cartridge between applications. The nozzle will keep the cartridge sealed until the next use.

27. Passenger side: Liberally apply Fusor® 108B on the strut housing area within the white line drawn earlier (see page 24, step 20, and Figure RB24 below).



RB24 – Passenger side

28. Bolt the repair bracket into place.

- Driver side: make sure the ABS harness is pulled through its hole in the repair bracket.
- Use the correct nuts (see Figure RB25, or RB26 on next page, as it applies).
- **Do not use air tools to tighten the bolts.**
- Torque all new bolts/nuts to 50 N•m (5.1 kg-m, 37 ft-lb).
- Secure all existing bolts.

28a. Make sure adhesive is cleaned from the existing threaded hole(s).

- Driver side, see Figure RB25.
 - Passenger side, see next page, Figure RB26.
- NOTE:** These holes are used to mount the ABS sensor connector cover.

29. If the ratchet strap was used, carefully remove it.

30. Clean excess adhesive from around the edges of the repair bracket.

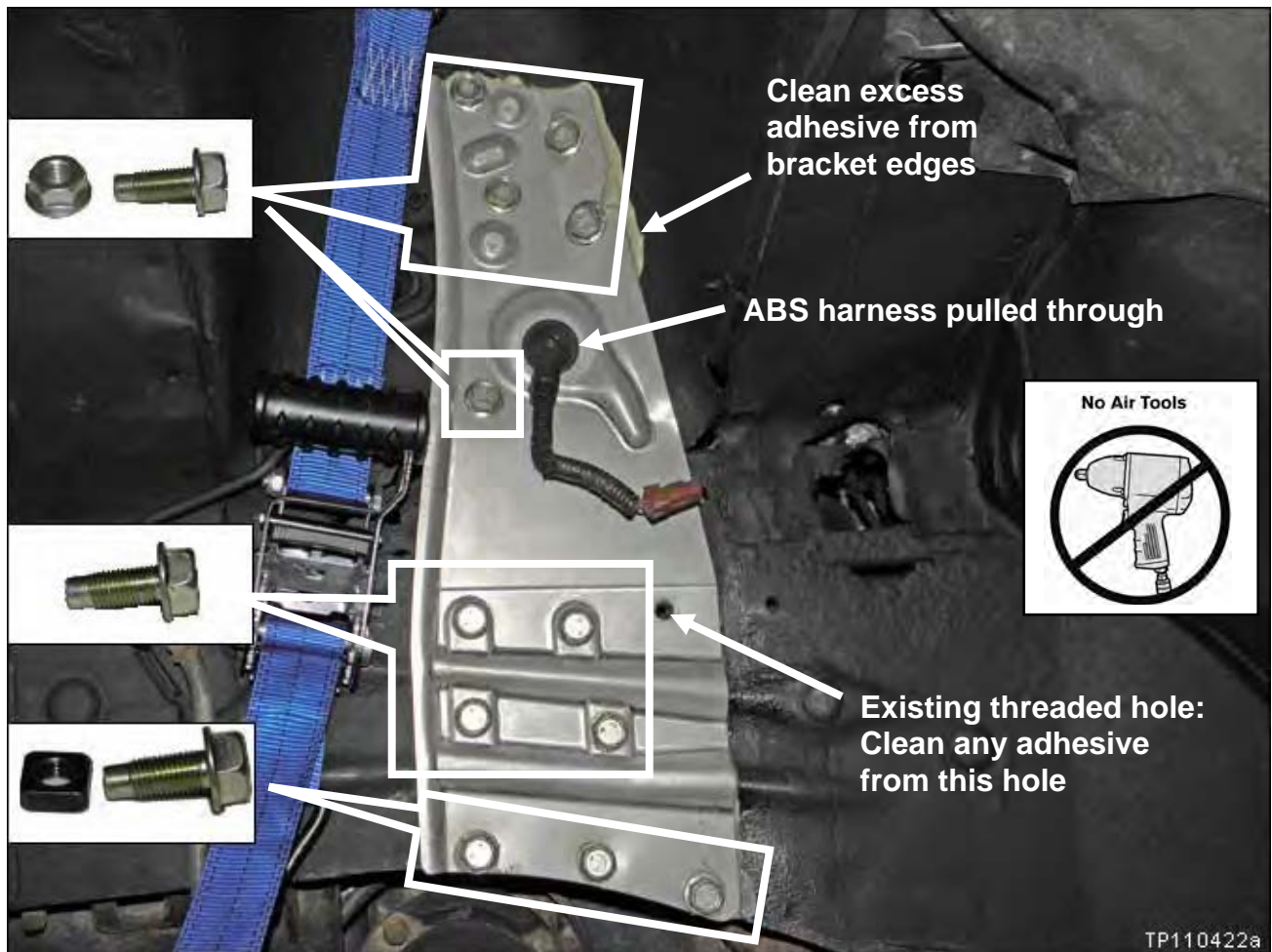

Figure RB25 – Driver side

NOTE: See additional repair bracket bolt installation information on page 33.

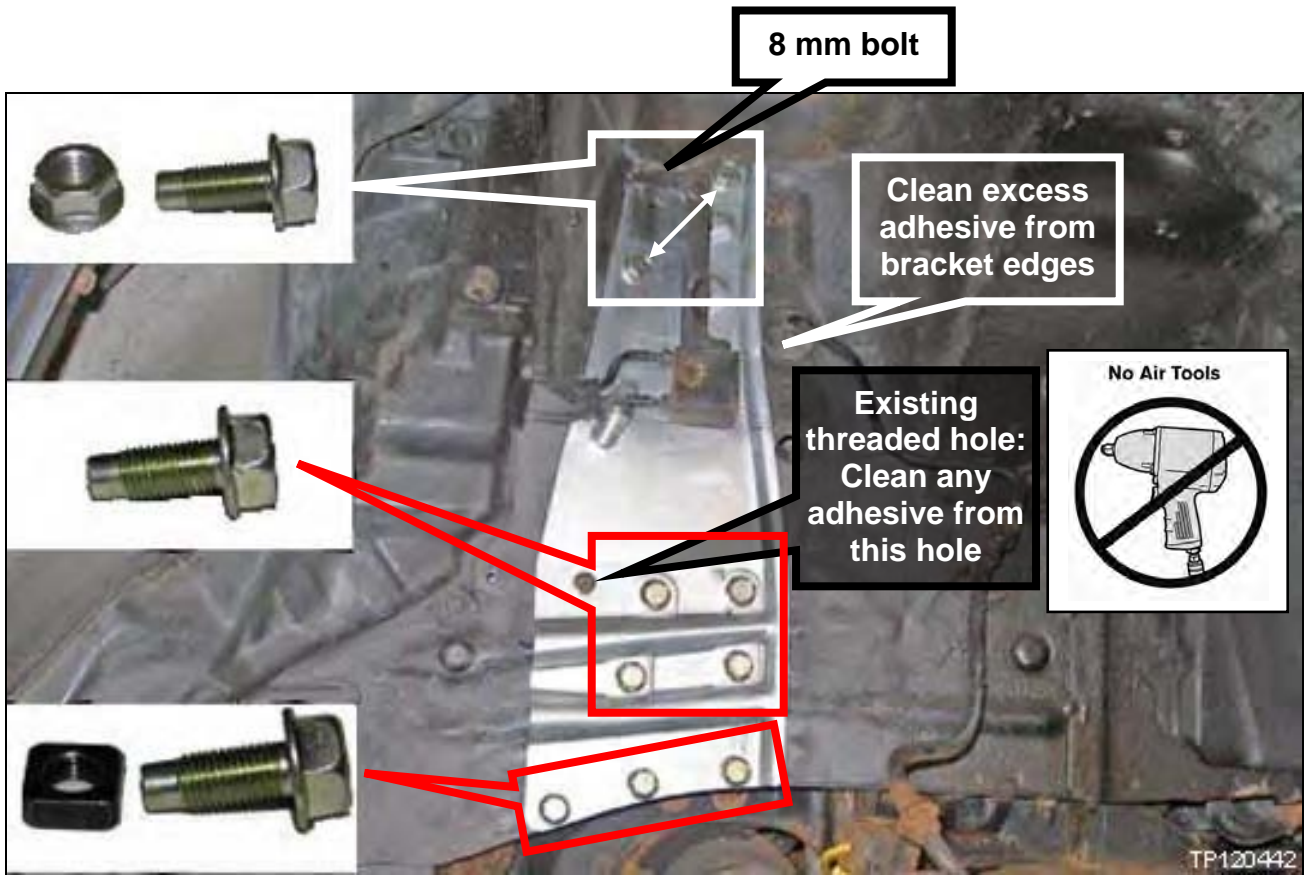

Figure RB26 – Passenger side

Additional Bolt Installation Information

Bolts that are preferred but not required (see Figure RB27):

- If these bolts do not have enough metal to support them (make them tight), use Lord Fusor® 108B to glue the bolts in the holes. **Do not leave open holes.** These bolts are preferred for bracket support, but not required.

Bolts with rivet nuts that Must accept the torque (see Figure RB27):

- These bolts are required and must accept the torque value of 50 N•m (5.1 kg-m, 37 ft-lb).
- If these bolts will not accept the specified torque value, the vehicle is not repairable:
 - a. Retain the vehicle at the dealer.
 - b. Supply the customer with a rental car.
 - c. Fax a completed Non-Repairable Report to Morley (see page 54).

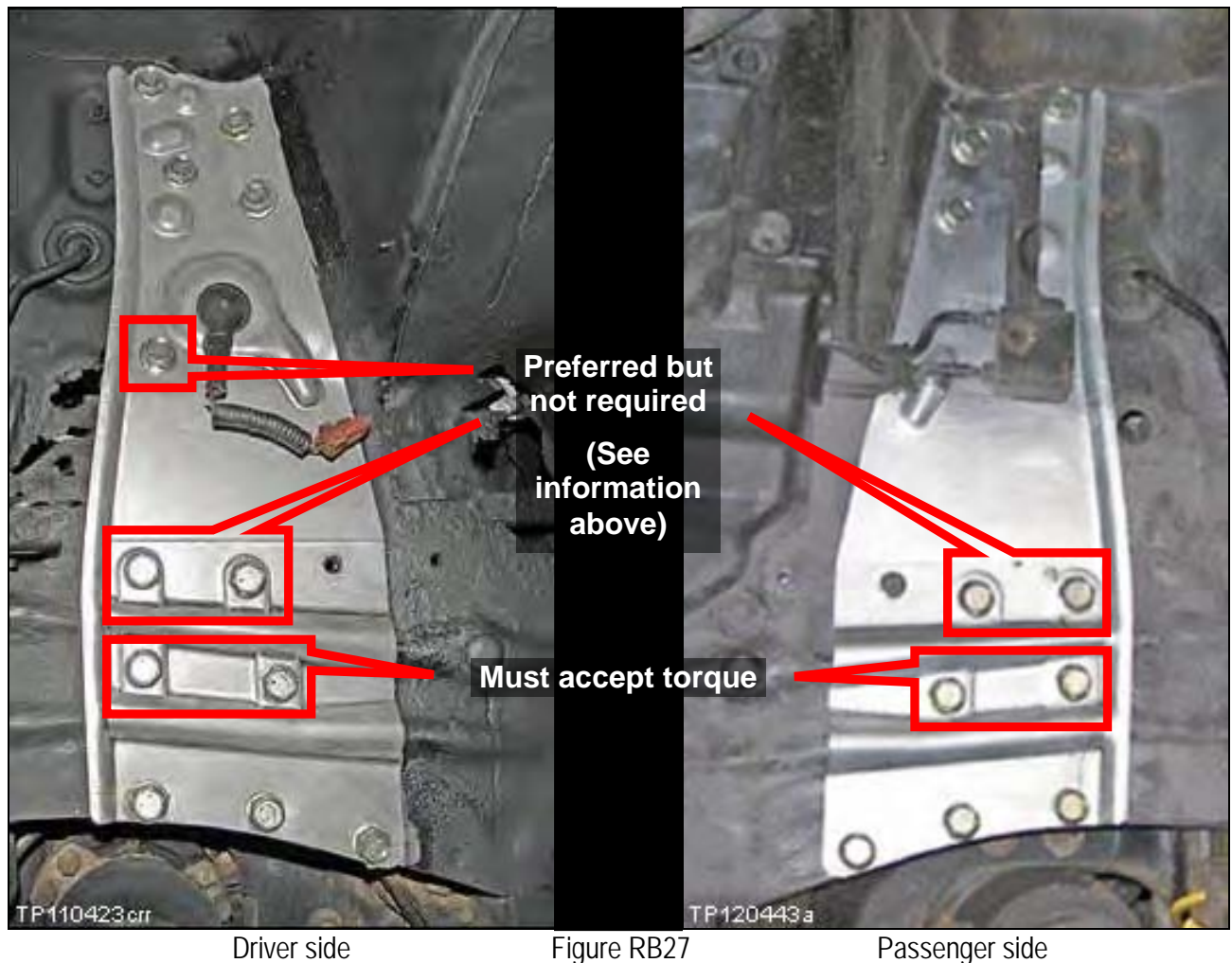

31. Inspect the metal brake lines under the hood and in the wheel house areas for damage due to contact with the separated strut housing.

- If there is damage, replace the line(s).
- Refer to the appropriate Service Manual for related brake line replacement information.

32. Driver side: Inspect the brake master cylinder for damage due to contact with the separated strut housing.

Contact with the strut housing may have occurred if the strut housing separated from the wheel house.

- If there is damage, replace the master cylinder.
- Refer to the appropriate Service Manual for brake master cylinder replacement information.



Figure RB28

Patching Perforated Areas

(Level 2 repair, driver side AND passenger side – continued)

NOTE: The photo in Figure RB29 is an example of possible perforation. The vehicle you are working on may have perforation in additional areas, areas different than these, or may not have any perforation.

If the vehicle you are working on does not have perforation, skip to step 36.

33. Cut fiberglass cloth to cover perforated areas (see example in Figure RB29).

- Cut cloth to cover at least 1 inch beyond the perforation on all sides, except when the perforation is next to the repair bracket.
- Where perforation is next to the repair bracket, cut cloth to fit along the edge of the repair bracket.
- If there is more than one perforation, cut fiberglass cloth for each perforated area.
- Use 3M™ Bondo Fiberglass Repair Kit (P/N 422) or equivalent.
- Use protective gloves (such as rubber gloves or disposable gloves) while working with fiberglass and resin.
- Do not install fiberglass patch on or over the repair bracket.

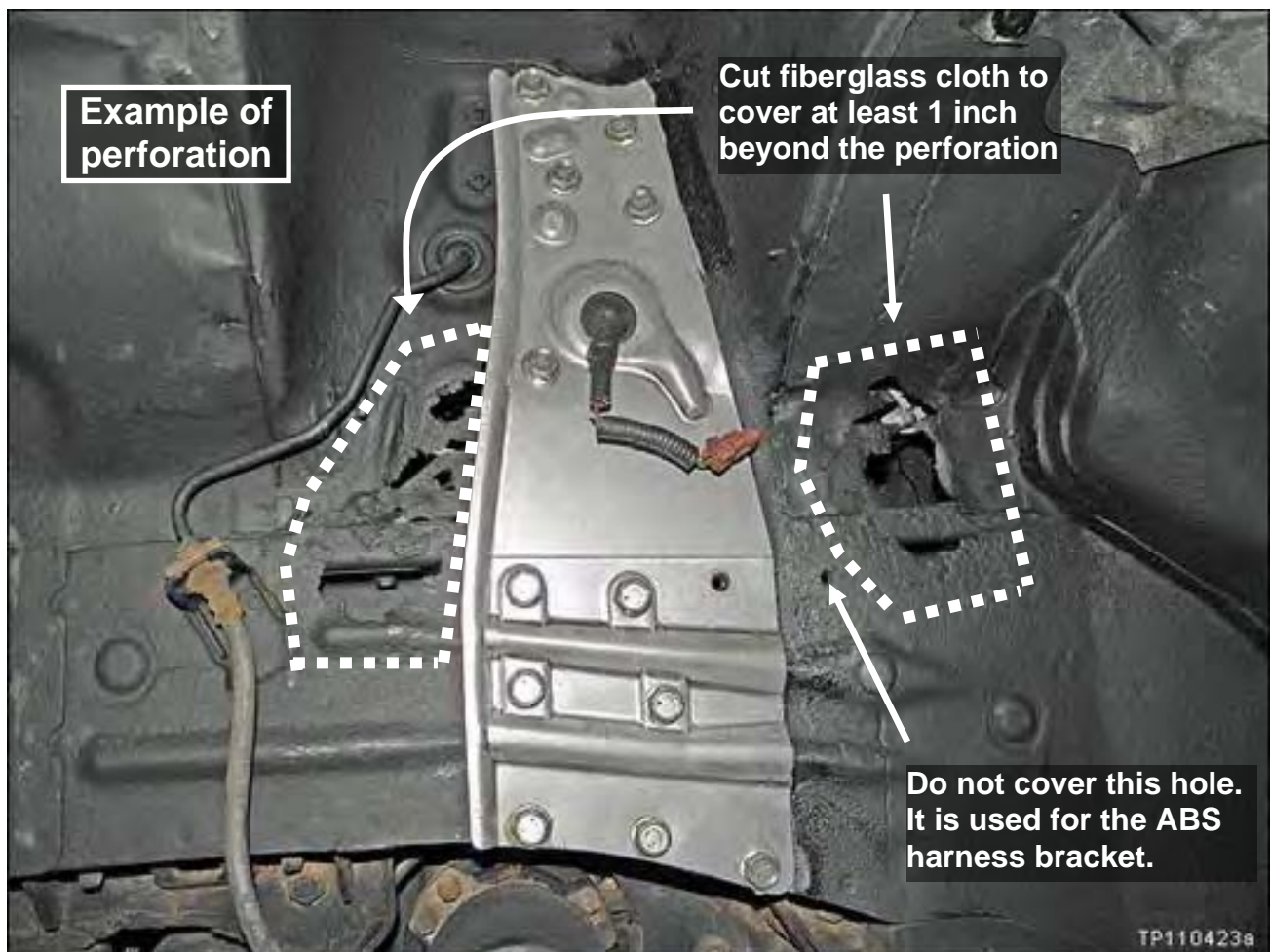

Figure RB29

34. Apply fiberglass patch to perforated areas.

- No additional surface preparation is needed.
 - Apply patch over the self etching primer.
 - Cleaning/grinding to bare metal **is not** needed.
- Use protective gloves (such as rubber gloves or disposable gloves) while working with fiberglass and resin.
- Follow all warnings and cautions for the fiberglass product being used.
- Follow the product instructions for applying the fiberglass patch.

WARNING: Perform repairs in a well ventilated area.

35. Allow the fiberglass patch and resin to harden before continuing (about 30 minutes).

36. Prepare for application of LORD Fusor® 800EZ (P/N 999MP – 9G000P) seam sealer.

- a. Load the cartridge into a 1:1 dispensing gun (see Figure RB30).
- b. Cut the tip at about ¼ inch diameter opening.

NOTE: Refer to the Parts Information for additional product detail.

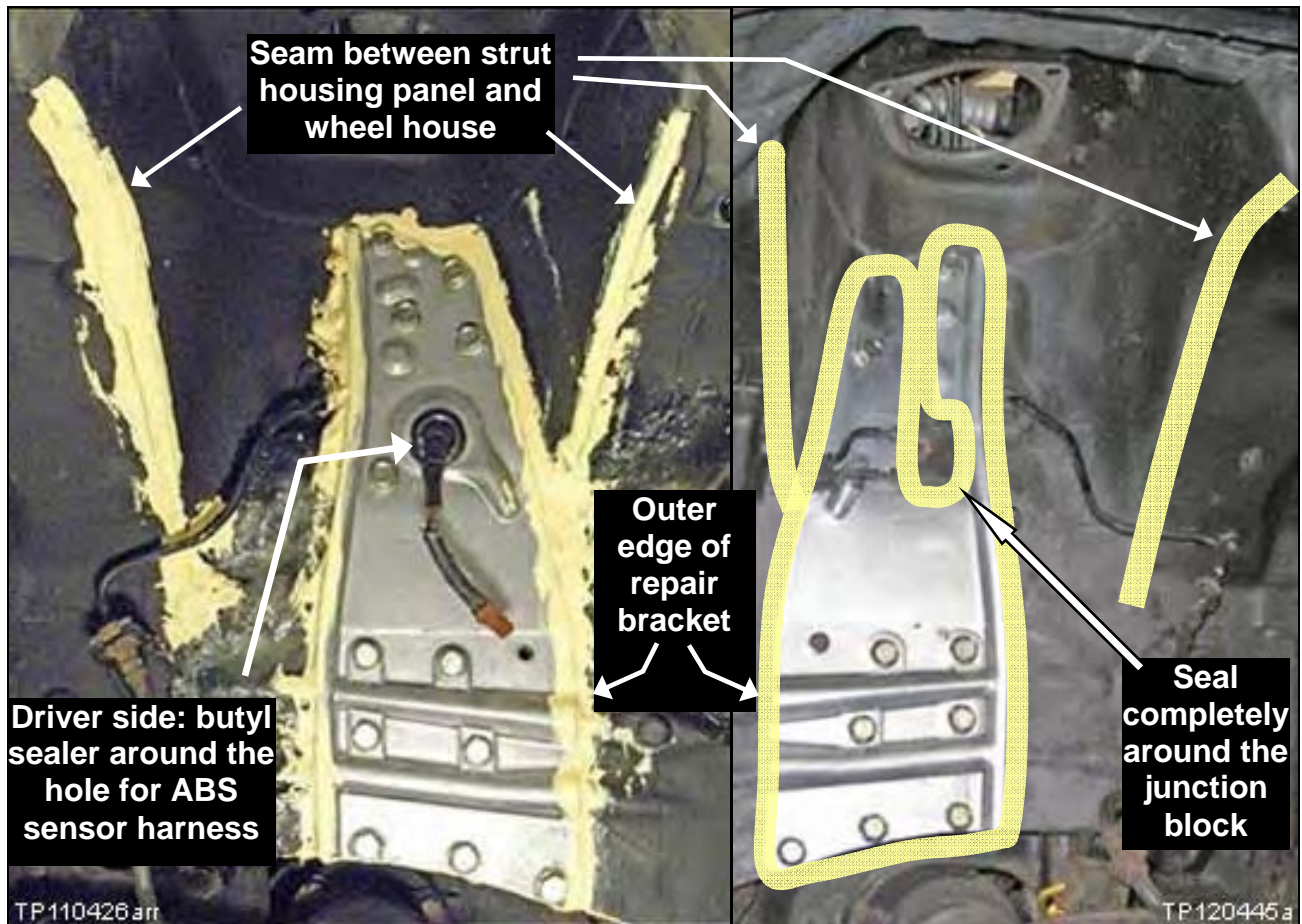

Figure RB30

37. Apply Fusor® 800EZ (seam sealer) as shown in Figure RB31.

- Apply around the outer edges of the repair bracket. Make sure all gaps are filled.
- Apply along the seams between the strut housing panel and the wheel house.
- Use a brush or other suitable tool to smooth the sealer for good seam coverage.
- Allow seam sealer to dry for 10-15 minutes.
- Passenger side: Also apply seam sealer around the brake line junction block.

38. Driver side: Apply Butyl Sealer (P/N B6553 – 89915) around the opening for the ABS sensor harness (see Figure RB31).



Driver side

Figure RB31

Passenger side

39. Driver side OR passenger side: Only if strut housing panel is separated:

Apply Fusor® 800EZ (seam sealer) as shown in Figure RB32.

- Apply along the front seam between the strut housing panel and the wheel house.
- Use a brush or other suitable tool to smooth the sealer for good seam coverage.
- Allow seam sealer to dry for 10-15 minutes.



Figure RB32

40. Completely and liberally coat the area shown in Figure RB33 (strut housing and wheel house area) with rubberized undercoat.

- Use 3M™ Rubberized Undercoating (P/N 051135 – 08883) or equivalent.
- Follow all product instructions.
- Coat all of the exposed metal areas on the strut housing and wheel house panels.

NOTE: Refer to the Parts Information for additional product details.

41. Inspect the ABS sensor harness covering – if needed use electrical tape to wrap the harness.

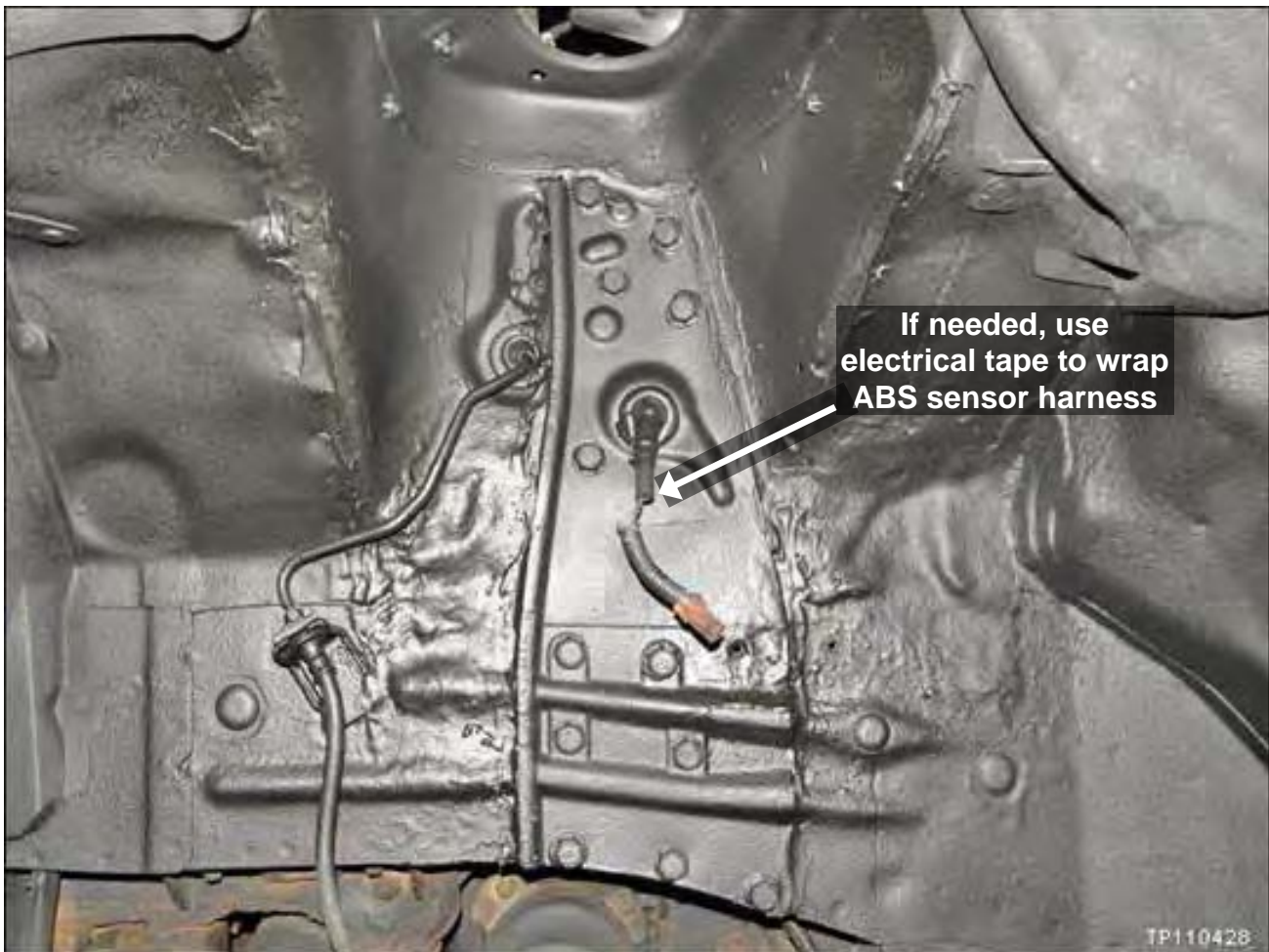

Figure RB33

42. Only if strut housing panel is separated:

Completely and liberally coat the area inside the dashed line shown in Figure RB34 with self etching primer.

- This is the under hood front of the strut housing panel.
- Use DuPont Etch Primer (P/N A-4119S™) or equivalent.
- Follow all product instructions.

NOTE: Refer to the Parts Information for additional product details.



Figure RB34

43. Driver side: If the steering shaft needs replacement, replace it at this time.

- Refer to steering shaft inspection, step 6 on page 18.
- Refer to Steering Shaft Replacement on page 42.

44. Driver side: Reinstall the air intake duct and the air filter box.

45. Reinstall the strut in reverse order of removal.

- Use **new** nuts for the upper strut mount (P/N 01225 - 00231).
- Nut torque is:
39-54 N•m (4.0 - 5.5 kg-m, 29-40 ft-lb)



Figure RB35

- Use **new** nuts for the lower strut mount (P/N 54588 – ED00A).

NOTE: Reuse the original bolts.

- Torque is:
151 – 165 N•m
(15.4 – 16.8 kg-m, 111 – 122 ft-lb)



Figure RB36

- Use a new clip for the brake line mount (P/N 46206 – 2J00A).
- Confirm the ABS sensor harness is mounted correctly as shown in Figure RB37.
- Make sure the brake line is not twisted.

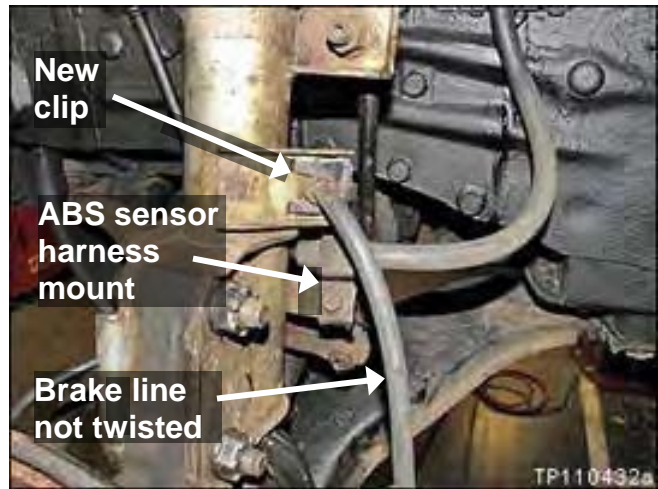

Figure RB37

- Use a new clip for the brake line mount (P/N 46206 – 2J00A).
- Make sure the brake line is not twisted.
- Confirm the ABS sensor harness is routed correctly behind the strut.
- Make sure the ABS sensor harness is mounted correctly as shown in Figure RB38.



Figure RB38

- Make sure the ABS sensor harness connector cover is installed as shown.
 - If the cover is missing, install a new one.
 - Coat the cover with 3M Rubberized Undercoating (P/N 051135 – 08883); don't get any undercoat on the strut rod.

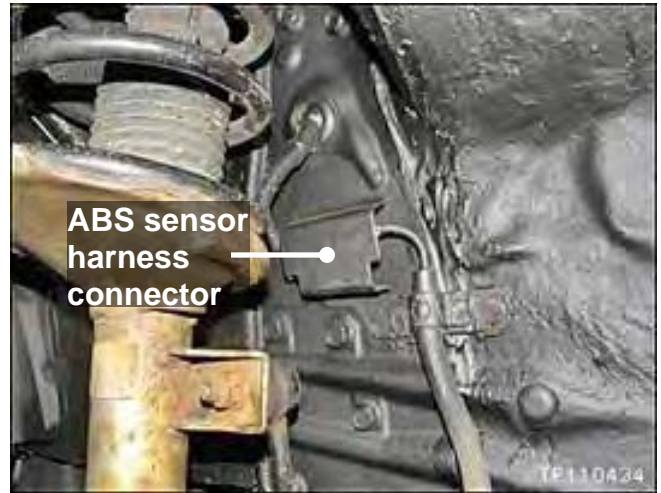

Figure RB39

46. Reinstall the wheel.

- Torque for wheel nuts is 118 – 147 N•m (12 – 15 kg-m, 87 – 108 ft-lb).

47. Check and adjust the front wheel toe.

NOTE: Do not wash for 24 hours. This will allow time for the undercoat to completely cure before exposure to water.

STEERING SHAFT REPLACEMENT

NOTE: Replace the steering column upper joint (steering shaft) only if needed. Refer to steering shaft inspection, step 6 on page 18.

1. Make sure the front wheels are positioned straight ahead.

2. Remove the clamp bolts at each end of the steering column upper joint (steering shaft).

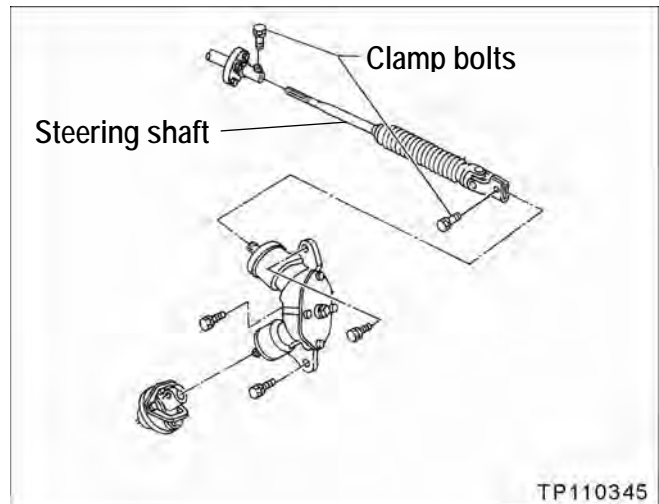

Figure SS1

3. Use a flat blade driver or other suitable tool to loosen both clamp ends of the steering shaft.

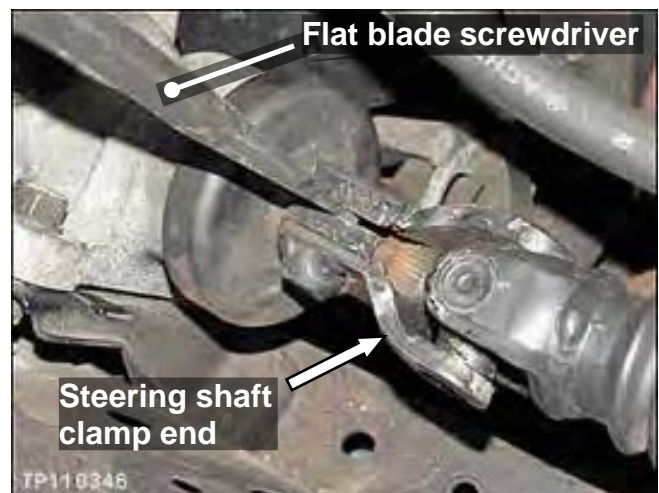

Figure SS2

4. Loosen the clamp ends enough so the steering shaft is loose at both ends.
 - Steering shaft will move back and forth a small amount.



Figure SS3

5. Set the steering wheel in the straight ahead position.
6. Position a steering wheel holding tool as shown.
 - This will keep the steering wheel stationary while replacing the steering shaft.



Figure SS4

NOTE: The marks shown in Figure SS5 should be aligned.

- Tab on transfer gear assembly
- Raised area on rubber cover
- Gap on steering shaft clamp



Figure SS5

7. Remove the 3 transfer gear assembly mounting bolts.

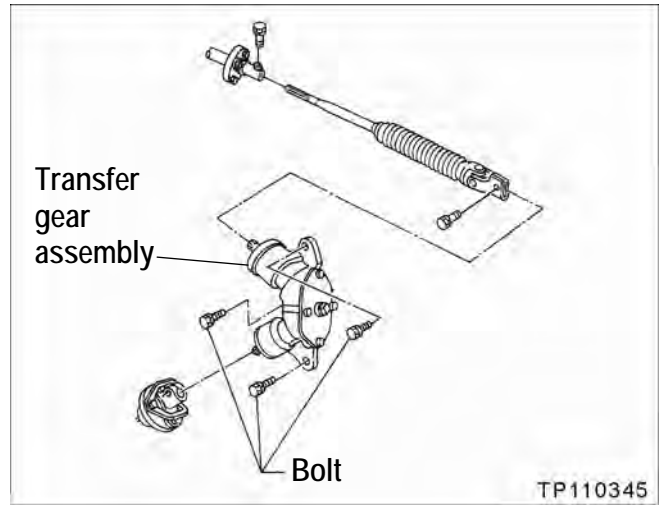

Figure SS6

8. Push the transfer gear assembly forward and remove the steering shaft.



Figure SS7

9. Pull the steering shaft to remove it from the other end.



Figure SS8

10. Install the new steering shaft in reverse order.

- The shaft end that goes towards the steering wheel is notched; it will go in only one way.
- Make sure shaft end at the steering gear assembly is aligned correctly (see Figure SS5 on page 43).

- Torque for steering gear assembly mounting bolts is:

20 – 29 N•m (2.0 – 3.0 kg-m, **14 – 22 ft-lb**)

- Torque for steering shaft clamp bolts (both ends) is:

24 – 29 N•m (2.4 – 3.0 kg-m, **17 – 22 ft-lb**)



EXAMPLE PHOTOS

Examples (Additional Photos) of Area 1 Perforation Inspection

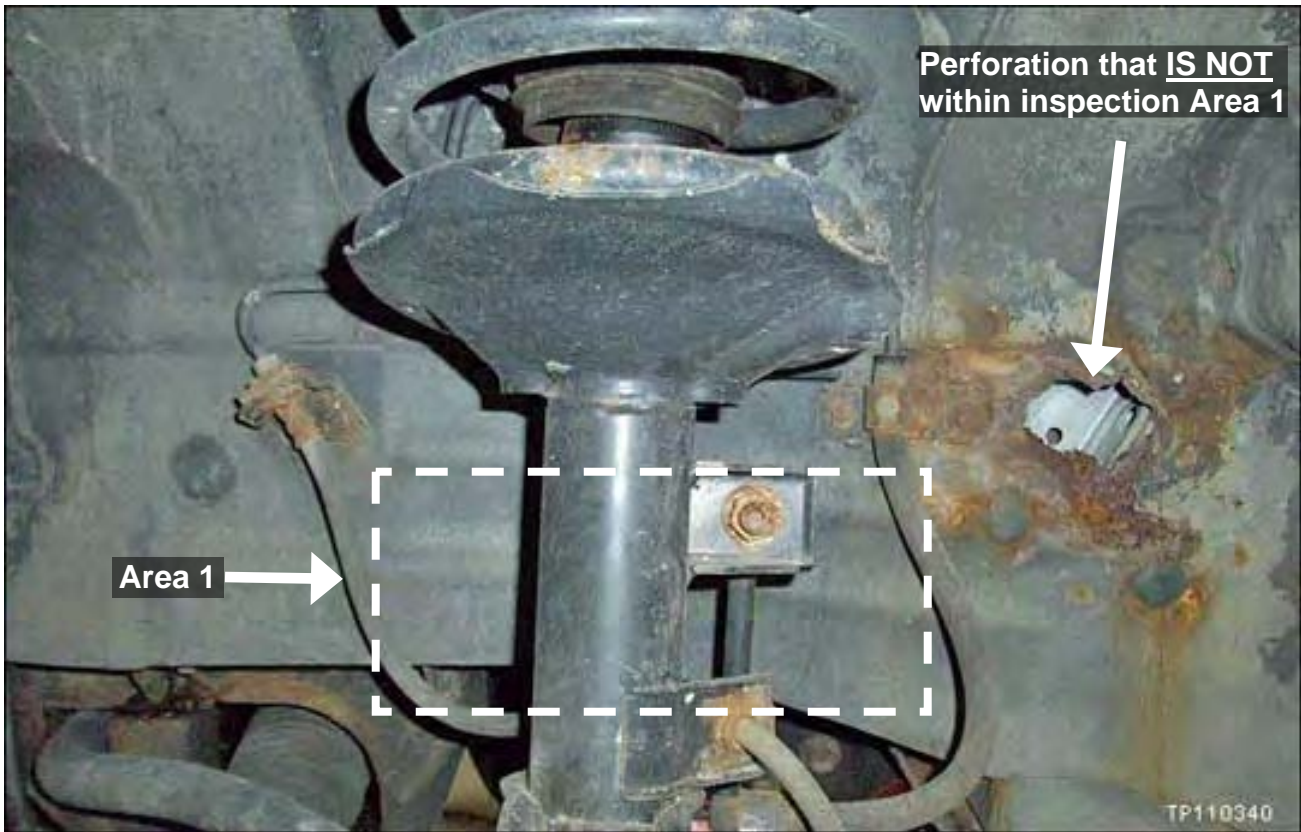

Example (Additional Photo) of Area 1 Perforation Inspection

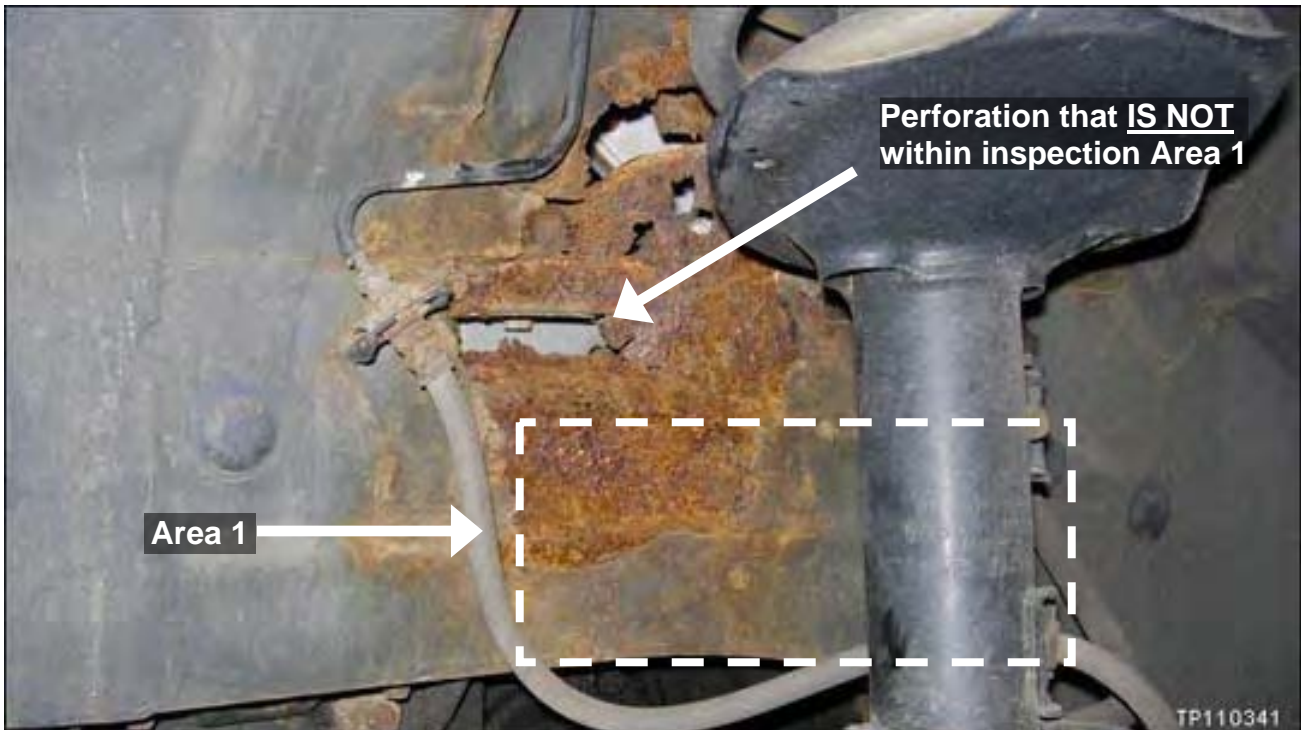

Example (Additional Photo) of Area 1 Perforation Inspection



Example (Additional Photo) of Area 2 Scab Corrosion Inspection

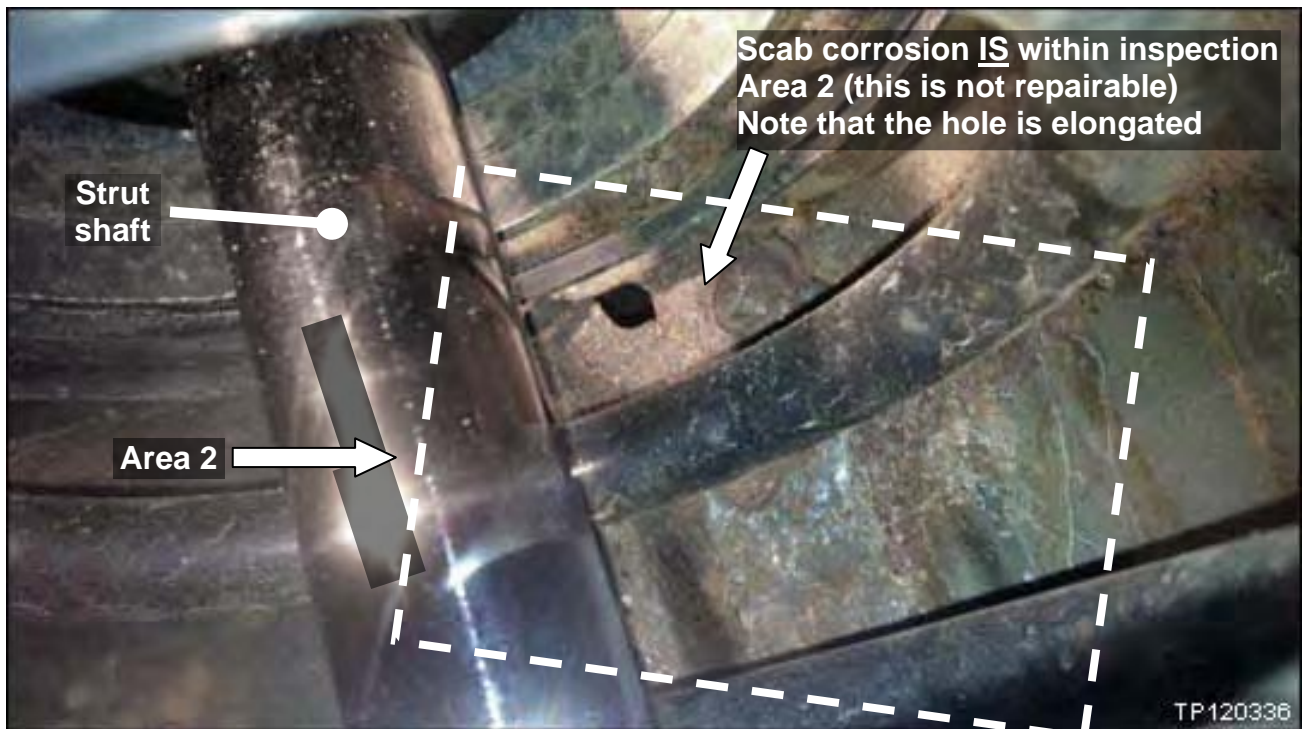

PARTS INFORMATION

Nissan Parts (Local PDC)

DESCRIPTION	PART #	QUANTITY
Repair Kit – Driver Side (Hood Ledge LH - Includes 1 repair bracket, 12 bolts, 8 nuts and 4 rivet nuts)	F4195 – 0W00C	1, if needed
Repair Kit – Passenger Side (Hood Ledge RH - Includes 1 repair bracket, 11 bolts, 6 nuts and 4 rivet nuts)	F4194-0W00A	1, if needed
Joint Assy-STR 14mm shaft (column upper joint – (steering shaft))	48070 – 0W00A or	1, if needed
Joint-Assy STR 17mm shaft (column upper joint – (steering shaft))	48070--0W001	1, if needed (June 2001-July 2001 production only)
Butyl Sealer (200 cm roll)	B6553 – 89915 (1)	1 roll will service approximately 20 vehicles
Clip (spring lock for brake line mounts)	46206 – 2J00A	2, for each strut removed
Nut (for lower strut mount)	54588 – ED00A	2, for each strut removed
Nut (for upper strut mount)	01225 – 00231	3, for each strut removed

(1) Do not list this part number on the claim. It is included in Expense Codes 101 and 104.

Other Products

DESCRIPTION	product # (2)	Source	QUANTITY	Expense Code
Self Etching Primer (DuPont Etch Primer)	A-4119S™ (or equivalent)	Local DuPont supplier	1 per vehicle (12 oz can)	100,103
3M Rubberized Undercoating	051135 – 08883 (or equivalent)	Local 3M™ supplier	1 per vehicle (24 oz can)	100
3M Bondo Fiberglass Repair Kit	422 (or equivalent)	Local 3M™ supplier	1 kit will service perforations for 8 strut/wheel housings	102
LORD Fusor® 108B (structural adhesive – includes 2 mixing nozzles)	999MP – 108BP	Nissan Chemicals	1 cartridge will service 2 repair bracket installations	101, 103
LORD Fusor® 800EZ (seam sealer)	999MP – 9G000P	Nissan Chemicals	1 cartridge for each repair bracket installation	101
Nissan Rust Penetrant	999MP-A3020P (or equivalent)	Nissan chemical	Shop Supply	-
Disposable mixing container for fiberglass resin (one time use)	N/A	Local source	1 container per side - level 2 repair	102
Disposable brush for application of fiberglass resin (one time use)	N/A	Local source	1 brush per side - level 2 repair	102
Isopropyl Alcohol		Local source	Shop Supply	-

(2) Do not list the above product numbers on the claim. Use the corresponding Expense Code.

Local DuPont Supplier: For help finding a local source for the DuPont product listed above or obtaining an MSDS, contact DuPont at 1-800-438-3876.

Local 3M™ Supplier: For help finding a local source for the 3M™ products listed above or obtaining an MSDS, contact 3M™ Automotive Aftermarket Division at 1-877-MMM-CARS.

Nissan Chemicals: Order this item through the Nissan Maintenance Advantage program: Phone: 877-NIS-NMA1 (877-647-6621), or website order via link on dealer portal www.NNAnet.com and click on "Maintenance Advantage-Tire/Wiper/Battery/Chemical" link. The MSDS for these chemicals will also be found on this site.

CLAIMS INFORMATION

Submit a Campaign (CM) line claim using the following claims coding:

“CM” I.D.: R1109

Not Repairable Program 1

CAMPAIGN ID	DESCRIPTION	OP CODE	FRT
R1109	Inspect only – vehicle is not repairable	R11090	0.3 hrs.

Repairable Program 2

CAMPAIGN ID	DESCRIPTION	OP CODE	FRT	EXPENSE CODE
R1109	Level 1 LH and Level 1 RH	R11091	1.6 hrs.	*100
*Each Expense Code can only be claimed once.				

Repairable Program 3

CAMPAIGN ID	DESCRIPTION	OP CODE	FRT	EXPENSE CODE
R1109	Level 2 LH and Level 1 RH	R11092	4.3 hrs.	*100,101
Combination	Description	Op code	FRT	
Only if needed	Replace Steering Column Upper Joint (Steering Shaft)	R1109A	0.3 hrs.	
Combination	Description	Op code	FRT	Expense code
Only if needed	Replace Brake Line – One Side	R1109B	0.3 hrs.	*006
Combination	Description	Op code	FRT	Expense code
Only if needed	Replace Brake Master Cylinder	R1109C	0.6 hrs.	*006
*Each Expense Code can only be claimed once.				

Repairable Program 4

CAMPAIGN ID	DESCRIPTION	OP CODE	FRT	EXPENSE CODE
R1109	Level 2 LH with Fiberglass Repair and Level 1 RH	R11093	4.6 hrs.	*100, 101,102
Combination	Description	Op code	FRT	
Only if needed	Replace Steering Column Upper Joint (Steering Shaft)	R1109A	0.3 hrs.	
Combination	Description	Op code	FRT	Expense code
Only if needed	Replace Brake Line – One Side	R1109B	0.3 hrs.	*006
Combination	Description	Op code	FRT	Expense code
Only if needed	Replace Brake Master Cylinder	R1109C	0.6 hrs.	*006
*Each Expense Code can only be claimed once.				

CLAIMS INFORMATION continued

Repairable Program 5

CAMPAIGN ID	DESCRIPTION	OP CODE	FRT	EXPENSE CODE
R1109	Level 2 LH w/o Fiberglass Repair and Level 2 RH with Fiberglass Repair	R11094	6.1 hrs.	*100, 102,104
Combination	Description	Op code	FRT	
Only if needed	Replace Steering Column Upper Joint (Steering Shaft)	R1109A	0.3 hrs.	
Combination	Description	Op code	FRT	Expense code
Only if needed	Replace Brake Line – One Side	R1109B	0.3 hrs.	*006
Combination	Description	Op code	FRT	Expense code
Only if needed	Replace Brake Line – Both Sides	R1109F	0.5 hrs.	*006
Combination	Description	Op code	FRT	Expense code
Only if needed	Replace Brake Master Cylinder	R1109C	0.6 hrs.	*006
*Each Expense Code can only be claimed once.				

Repairable Program 6

CAMPAIGN ID	DESCRIPTION	OP CODE	FRT	EXPENSE CODE
R1109	Level 2 LH with Fiberglass Repair and Level 2 RH with Fiberglass Repair	R11095	6.4 hrs.	*100, 102,104
Combination	Description	Op code	FRT	
Only if needed	Replace Steering Column Upper Joint (Steering Shaft)	R1109A	0.3 hrs.	
Combination	Description	Op code	FRT	Expense code
Only if needed	Replace Brake Line – One Side	R1109B	0.3 hrs.	*006
Combination	Description	Op code	FRT	Expense code
Only if needed	Replace Brake Line – Both Sides	R1109F	0.5 hrs.	*006
Combination	Description	Op code	FRT	Expense code
Only if needed	Replace Brake Master Cylinder	R1109C	0.6 hrs.	*006
*Each Expense Code can only be claimed once.				

CLAIMS INFORMATION continued

Repairable Program 7

CAMPAIGN ID	DESCRIPTION	OP CODE	FRT	EXPENSE CODE
R1109	Level 1 LH and Level 2 RH with Fiberglass Repair	R11096	4.2 hrs.	*100, 101,102
Combination	Description	Op code	FRT	Expense code
Only if needed	Replace Brake Line – One Side	R1109B	0.3 hrs.	*006
*Each Expense Code can only be claimed once.				

Non repairable Program 8 **

CAMPAIGN ID	DESCRIPTION	OP CODE	FRT	EXPENSE CODE
R1109	Level 2 LH or RH – 1 or both bolts will not torque	R11097	3.4 hrs.	*103
*Each Expense Code can only be claimed once.				

**As explained on page 33 and shown in Figure RB27.

Repairable Program 9

CAMPAIGN ID	DESCRIPTION	OP CODE	FRT	EXPENSE CODE
R1109	Level 1 LH and Level 2 RH w/o Fiberglass Repair	R11098	3.9 hrs.	*100, 101
Combination	Description	Op code	FRT	Expense code
Only if needed	Replace Brake Line – One Side	R1109B	0.3 hrs.	*006
*Each Expense Code can only be claimed once.				

Repairable Program 10

CAMPAIGN ID	DESCRIPTION	OP CODE	FRT	EXPENSE CODE
R1109	Level 2 LH with Fiberglass Repair and Level 2 RH w/o Fiberglass Repair	R11099	6.1 hrs.	*100, 102,104
Combination	Description	Op code	FRT	
Only if needed	Replace Steering Column Upper Joint (Steering Shaft)	R1109A	0.3 hrs.	
Combination	Description	Op code	FRT	Expense code
Only if needed	Replace Brake Line – One Side	R1109B	0.3 hrs.	*006
Combination	Description	Op code	FRT	Expense code
Only if needed	Replace Brake Line – Both Sides	R1109F	0.5 hrs.	*006
Combination	Description	Op code	FRT	Expense code
Only if needed	Replace Brake Master Cylinder	R1109C	0.6 hrs.	*006
*Each Expense Code can only be claimed once.				

EXPENSE CODES

EXPENSE CODE	DESCRIPTION	MAX AMOUNT
100	Primer and Undercoat	\$47.88
101	Adhesive, Seam Sealer, and Butyl	\$68.37
104	Adhesive, Seam Sealer, and Butyl (For Level 2 Repair Both Sides)	\$135.56
102	Fiberglass Patch, mixing container, and brush	\$2.70
103	Primer and Adhesive	\$74.18
006	Brake Fluid	\$7.98
502	Rental Car	Actual Cost DO NOT use "Goodwill" for rental car reimbursement

- Each expense code can be claimed only once per repair order.
- Corresponding op-code must be claimed with each expense code.

OWNER LETTER

Dear Infiniti owner:

This second notice is sent to you in accordance with the requirements of the National Traffic and Motor Vehicle Safety Act. Infiniti has decided that a defect that relates to motor vehicle safety exists in some 1997-2003 model year Infiniti QX4 vehicles. Our records indicate that you own or lease the Infiniti vehicle identified by the VIN on the cover of this notice.

Reason for Recall

Infiniti recently discovered that, in certain instances, in states where heavy concentrations of road salt are used in the winter, the front driver's side strut tower housing can develop corrosion that may cause strut tower housing damage. In certain cases this may allow the strut tower housing to contact the steering column. This would create noise and a noticeable difference in steering effort. If not addressed, this may lead to steering system damage and possibly brake line damage, which could result in a crash.

In the states listed below where there is heavy use of road salt in the winter and corrosion is likely to occur, the dealers will inspect the strut housing and determine the appropriate remedy outlined below.

Connecticut	Maine	New Hampshire	Vermont
Delaware	Maryland	New Jersey	West Virginia
District of Columbia	Massachusetts	New York	Wisconsin
Illinois	Michigan	Ohio	
Indiana	Minnesota	Pennsylvania	
Iowa	Missouri	Rhode Island	

According to our records, your vehicle is currently registered in one of the states listed above.

What Infiniti Will Do

In the states shown in the table above, where there is heavy use of road salt in the winter and corrosion is likely to occur, the dealer will inspect the strut housing and perform the following:

- If no corrosion or only minor surface corrosion is present, an anti-corrosion sealant will be applied.
- If moderate corrosion is present, resin patches will be applied in addition to the sealant.
- If there is evidence of more significant corrosion, a metal reinforcement plate will be used to reinforce the strut housing assembly.

The repair will vary based up the remedy required. In rare instances where it is impossible to repair the vehicle, Infiniti will provide an appropriate remedy.

What You Should Do

Contact your Infiniti dealer at your earliest convenience in order to arrange an appointment to have your vehicle inspected. Please bring this notice with you when you keep your service appointment. Instructions have been sent to your Infiniti dealer.

If you have paid to have your strut housing sheet metal repaired due to corrosion prior to this campaign, you may be eligible for reimbursement of the related expense. If you have additional questions you may contact the National Consumer Affairs Department, Infiniti Division, Nissan North America, Inc., P.O. Box 685003, Franklin, TN 37068-5003. The toll free number is 1-800-662-6200. You may also submit a complaint to the Administrator, National Highway Traffic Safety Administration, 1200 New Jersey Avenue, SE., Washington, DC 20590; or call the toll-free Vehicle Safety Hotline at 1-888-327-4236 (TTY: 1-800-424-9153); or go to <http://www.safercar.gov>.

Federal law requires that any vehicle lessor receiving this recall notice must forward a copy of this notice to the lessee within ten days.

Thank you for your cooperation. We are indeed sorry for any inconvenience this may cause you.

NON REPAIRABLE REPORT

If it is determined that the vehicle is **not repairable** based on the presence of perforation or scab corrosion, complete the form below and Fax it to Morley (see Fax # below).

- Dealer faxes inspection form to Morley.
- Morley contacts the customer within 24 hours to explain the next steps.
- Morley schedules and performs an inspection to confirm the dealer's findings.
- Morley will negotiate with the customer.
- Morley will schedule a surrender date and provide the dealer with instructions and a package of documents.
- After surrender Morley will arrange the vehicle pickup and scrap.

 INFINITI.		NISSAN NORTH AMERICA, INC.	
QX4 Strut Corrosion Campaign - Vehicle Not Repairable			
CUSTOMER / VEHICLE INFORMATION			
LAST NAME:		FIRST NAME:	
ADDRESS:			APT #:
CITY:		DEALER NAME:	
STATE:		DEALER CODE:	REGION:
ZIP CODE:		CONTACT:	
DAY TIME#:		TELEPHONE:	
CELL #:		VIN:	
ALT#:		MAKE/MODEL: Infiniti QX4	MILEAGE:
EMAIL:		MODEL YEAR:	SEC + #:
NNA Internal Use:			
ORIGINATOR CODE = DI	TREAD =VEHICLE CONCERNS / SUSPENSION FRONT STRUT(S) / FINANCIAL ASSISTANCE REQUEST (CAMPAIGN/RECALL)		
PLEASE REMEMBER TO DOCUMENT ALL FIELDS			
COMMENTS:			

Morley	
Fax #	Helpdesk #
877-276-2445	877-477-2292