



Program Bulletin



CUSTOMER SATISFACTION PROGRAM

SUBJECT: Enhancements for Side Impact Pole Performance

MODELS: 2011-2012 Chevrolet Volt

CONDITION

The 2011 and 2012 model year Chevrolet Volt vehicles passed all Motor Vehicle Safety Standards. A vehicle inspection following a side pole test, however, indicated that the vehicle experienced structural intrusion of approximately 50 mm into the battery, which may rupture the coolant line causing coolant leakage. If a vehicle with a leaking coolant system was left on its side or in an inverted position for an extended period of time, the coolant could flow onto the battery electronic controls on top of the battery pack. If the battery pack had not been depowered, after several days (at least 6 and likely much longer), a short circuit may occur and result in a vehicle fire.

CORRECTION

Dealers are to add a reinforcement bracket to further protect the battery pack in a severe side collision, replace the battery coolant system reservoir with a new reservoir that includes a sensor to monitor the coolant level, and add a tamper-resistant bracket to the top of the battery coolant reservoir to help prevent potential coolant overfills.

VEHICLES INVOLVED

Involved are **all** 2011 model year and **certain** 2012 model year Chevrolet Volt vehicles.

Important: Dealers are to confirm vehicle eligibility prior to beginning repairs by using the Required Field Actions section in the Global Warranty Management system. Not all vehicles may be involved.

For dealers with involved vehicles, a listing with involved vehicles containing the complete vehicle identification number, customer name, and address information has been prepared and will be provided to US and Canadian dealers through the GM GlobalConnect Recall Reports, or sent directly to export dealers. Dealers will not have a report available if they have no involved vehicles currently assigned.

The listing may contain customer names and addresses obtained from Motor Vehicle Registration Records. The use of such motor vehicle registration data for any purpose other than follow-up necessary to complete this program is a violation of law in several states/provinces/countries. Accordingly, you are urged to limit the use of this report to the follow-up necessary to complete this program.

PART INFORMATION

Parts required to complete this program are to be obtained from two different sources.

Parts listed in the table below are to be obtained from General Motors Customer Care and Aftersales (GMCC&A). Please refer to your "involved vehicles listing" before ordering parts. Normal orders should be placed on a DRO = Daily Replenishment Order. In an emergency situation, parts should be ordered on a CSO = Customer Special Order.

Part numbers 22920448, 22922225, and 19260759 are not eligible for RIM.

Part Number	Description	Quantity/Vehicle
22920448	Reinforcement Kit, F/Flr Tun	1
22922225	Battery Kit, Drv Mot (bottle/sensor kit)	1
19260759	Connector, Wrg Harn	1
12378390 - US 10953456 - CN	Coolant, Engine	2

The part listed in the table below is to be obtained from **Crest Industries, Inc.** by calling 1-800-822-4100 (U.S.) or J-2 Products at 1-888-880-0025 or 416-665-1404 (Canada), 8:00 am - 4:30 pm ET.

Part Number	Description	Quantity/Vehicle
7770B220	Ashland Pliogrip	1

SERVICE PROCEDURE

Perform a visual inspection of the drive motor battery cooling system reservoir fluid level **BEFORE** completing the service repairs in this bulletin.

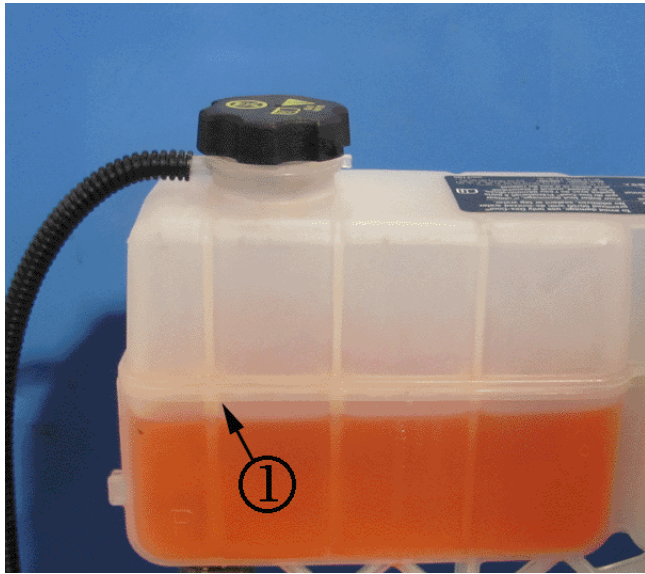

2770857

- If the coolant level of the drive motor cooling system reservoir is **below the seam of the reservoir (1)**, perform leak inspection diagnostics **BEFORE** proceeding to the service repair in this bulletin. Refer to SI for the appropriate leak inspection diagnostic information. Submit a warranty claim for leak inspection diagnostics and service repairs. After completing the inspection and repairs, proceed to the service repairs in this bulletin.
- If the drive motor cooling system reservoir is **NOT below the seam of the reservoir (1)**, proceed to the service repairs in this bulletin.

Note: The service repairs in this bulletin must be performed at a GM dealership that is authorized to perform Volt repair work. Only Volt certified technicians are to perform the repairs in this bulletin.

Battery Tunnel Reinforcement Installation

Note: The following tools are required to complete the battery tunnel reinforcement procedure:

- A compact quality drill.
- Drill bits that will drill through high strength steel. The drill bits are provided in kit P/N22920448.
- A pneumatically powered pop rivet gun that accepts 6.35 mm (¼ in), 4.76 mm (3/16 in), 3.96 mm (5/32 in) and 3.17 mm (1/8 in) rivets.
- Dual Cartridge Applicator for Pliogrip two-part polyurethane
- Small disposable brush for spreading the Pliogrip two-part polyurethane
- Butyl, 3M P/N 08578, 3M P/N 08612, or equivalent.
- RTV, P/N 88864346, (or equivalent)

Danger: Always perform the High Voltage Disabling procedure prior to servicing any High Voltage component or connection. Personal Protection Equipment (PPE) and proper procedures must be followed. The High Voltage Disabling procedure includes the following steps:

- Identify how to disable high voltage.
- Identify how to test for the presence of high voltage.
- Identify condition under which high voltage is always present and personal protection equipment (PPE) and proper procedures must be followed.

Before working on any high voltage system, be sure to wear the following Personal Protection Equipment:

- Safety glasses with appropriate side shields when within 15 meters (50 feet) of the vehicle, either indoors or outdoors.
- Certified and up-to-date Class "0" Insulation gloves rated at 1000V with leather protectors.
- Visually and functionally inspect the gloves before use.
- Wear the Insulation gloves with leather protectors at all times when working with the high voltage battery assembly, whether the system is energized or not.

Failure to follow the procedures may result in serious injury or death.

1. Disconnect and remove the high-voltage battery from the vehicle. Refer to *Drive Motor Battery Replacement and Shipping* in SI.

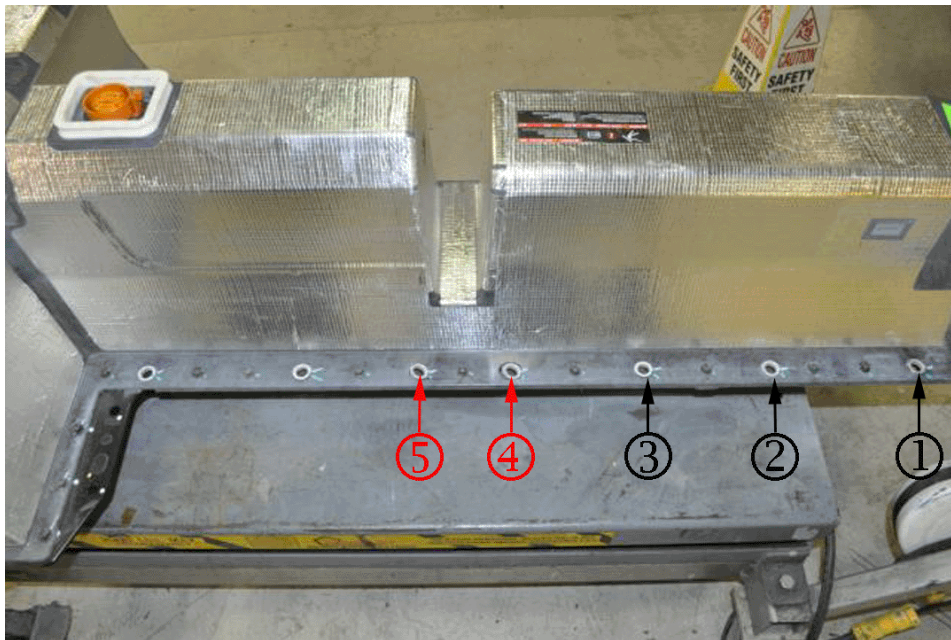

2756827

Caution: Do not pry on or contact the battery RESS cover while removing the aluminum crush limiters with screwdriver.

2. Remove the 4th and 5th aluminum crush limiters (indicated with red arrows in illustration) from the driver's and passenger's side of the battery RESS cover.



2756850

- 2.1 Place the tip of a small flat-blade screwdriver against the bottom of each aluminum crush limiter. Access the bottom of the crush limiter through the hole on the bottom side of the battery RESS cover.
- 2.2 Gently tap the end of the screwdriver with a small hammer. You may have to work around the bottom of the aluminum crush limiter, tapping it in a few locations to completely free the aluminum crush limiter from the cover.

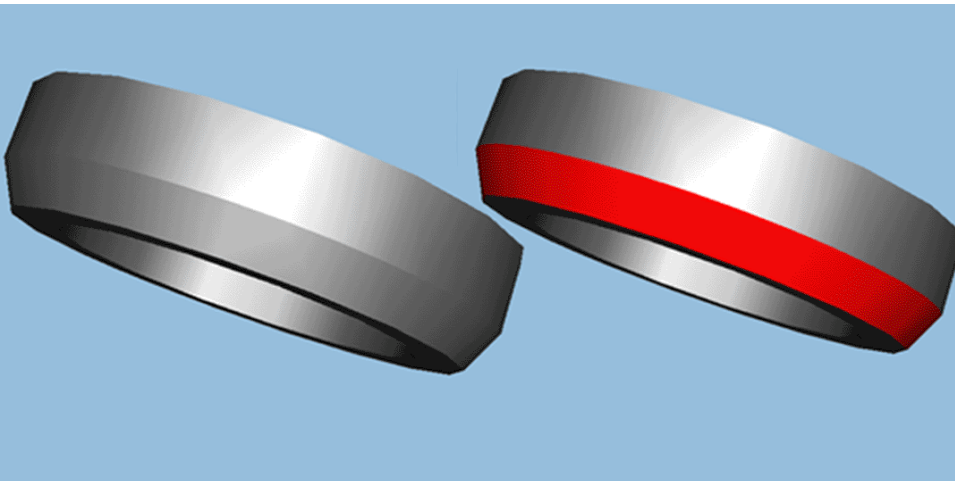

2756839

Note: Butyl should only be applied in the chamfer (red face) of the crush limiter. Refer to illustration. Butyl should not be present in the metal-to-metal joint between RESS cover, reinforcement plate and longitudinal rails.

3. Apply a butyl-based sealer such as 3M Ribbon Sealer 08612 or 3M Strip-Caulk 08578 (or equivalent) on the chamfer of the new aluminum crush limiters, P/N 22917161.

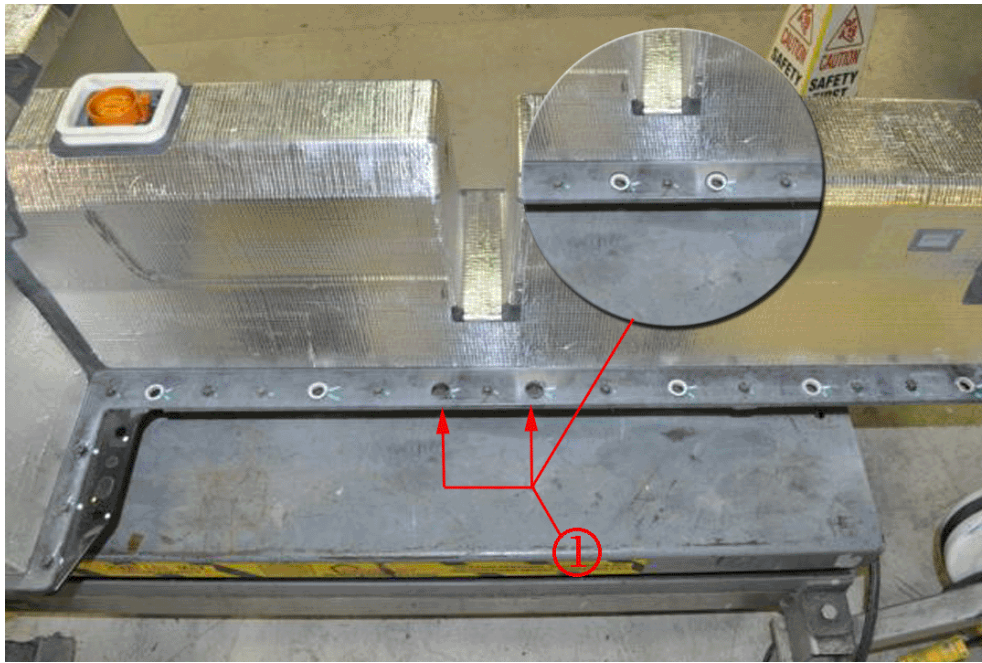

2756830

Note: The aluminum crush limiters are chamfered and must be installed with chamfer side down.

4. Press the four new aluminum crush limiters (1), P/N 22917161, into the battery RESS cover where the aluminum crush limiters were removed.

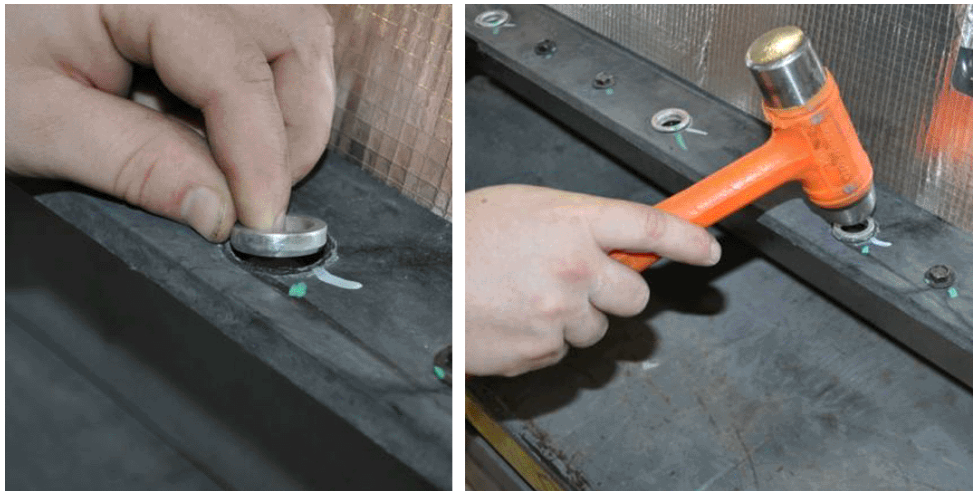

2756843

5. Install the new aluminum crush limiters by tapping lightly and evenly with small hammer.
6. Remove the excess butyl on the RESS cover.



2756855

7. Attach the reinforcement assembly (1) to the car body using the four shorter M10 bolts from the kit. Tighten bolts to 25 Nm (19 lb-ft). Make sure the reinforcement assembly is centered from side to side within the tunnel of the vehicle body.



2756857

8. Locate the front and rear plates to the car body and hold in position using two hand clamps or "C" clamps. Make sure the front and rear plates are centered from side to side on the tunnel reinforcement of the vehicle body.



2756888

9. Center punch all of the holes in the plates and reinforcement assembly before drilling the 3mm (1/8 in) pilot holes.

Caution: To increase the useful life of the drill bit, drill the holes into the vehicle body at a low speed. The appropriate drill speed will allow the drill bit to cut into the metal efficiently. The drill bit will remove metal chips or metal shavings from the high strength steel quickly if the appropriate drill speed is used. Ensure the drill used at a low speed for steps 10-14.

10. Drill 3mm (1/8 in) pilot holes into the vehicle body through the 20 existing holes in the front and rear plates. The three lower holes per plate will also go through the reinforcement assembly.
11. Drill 6.75mm (17/64 in) holes through the 20 pilot holes.
12. Remove the clamps and the front and rear plates. Set aside the plates.

Caution: To avoid vehicle damage, place a drill stop on drill bits to ensure drill does NOT enter the vehicle beyond 19 mm (3/4 in) in depth.

13. Drill 3mm (1/8 in) pilot holes into the vehicle body through the 28 existing holes in the reinforcement assembly. Do not allow the drill bit to enter the vehicle body beyond 19 mm (3/4 in) in depth for the six upper holes on each side.



2756882

Caution: To avoid vehicle damage, place a drill stop on drill bits to ensure drill does NOT enter the vehicle beyond 19 mm (3/4 in) in depth.

14. Drill 6.75mm (17/64 in) holes through the 28 pilot holes from step 13. Use a drill stop or otherwise do not allow the drill bit to enter the car body beyond 19 mm (3/4 in) in depth for the six upper holes on each side.
15. Remove the four M10 bolts and the reinforcement assembly from the vehicle body. Set aside the reinforcement assembly and the bolts.
16. Deburr all of the drilled holes in the front and rear plates, the reinforcement assembly, and the vehicle body. Remove any metal shavings from the surfaces of the front and rear plates, the reinforcement assembly, and the vehicle body.
17. Clean all mating surfaces of the front and rear plates, the reinforcement assembly, and the vehicle body using isopropyl (rubbing) alcohol and a clean, lint-free cloth. Allow the alcohol to dry.

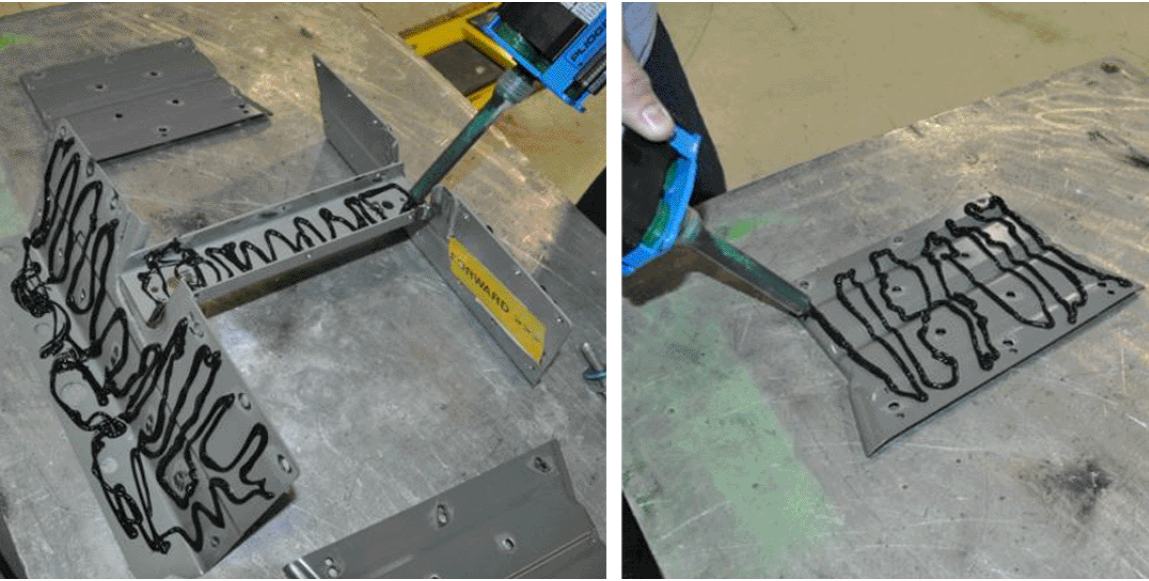

2756863

Caution: Ensure the Pliogrip two-part polyurethane mix is uniform in color BEFORE applying it to the parts. Discard the first 25 mm (1 in) of the mix that is not uniform. The color of the polyurethane varies. The illustrations in this bulletin show the polyurethane mix in black or green. The Pliogrip two-part polyurethane has a 30-minute open time. The application of the Pliogrip two-part polyurethane and the assembly of the reinforcement assembly must be completed in 30 minutes.

18. Apply approximately 5mm (3/16 in) beads of Pliogrip two-part polyurethane, P/N 7770B220, in the patterns shown onto the reinforcement assembly and the front and rear plates. Use a new mixing and dispensing tip, and ensure that both components of the polyurethane are dispensing and mixing from the dispensing tip prior to applying the polyurethane to the parts.



2756814

19. Coat drill holes and exposed metal with Pliogrip, P/N 7770B220, two-part polyurethane using a brush as shown in illustration.



2756872

20. Re-attach the reinforcement assembly to the vehicle body using the four shorter M10 bolts (1). Tighten bolts to 25 Nm (19 lb-ft). Make sure the reinforcement assembly is centered from side to side within the tunnel of the vehicle body. Ensure that the 6.75mm (17/64 in) holes drilled into the reinforcement assembly are aligned.

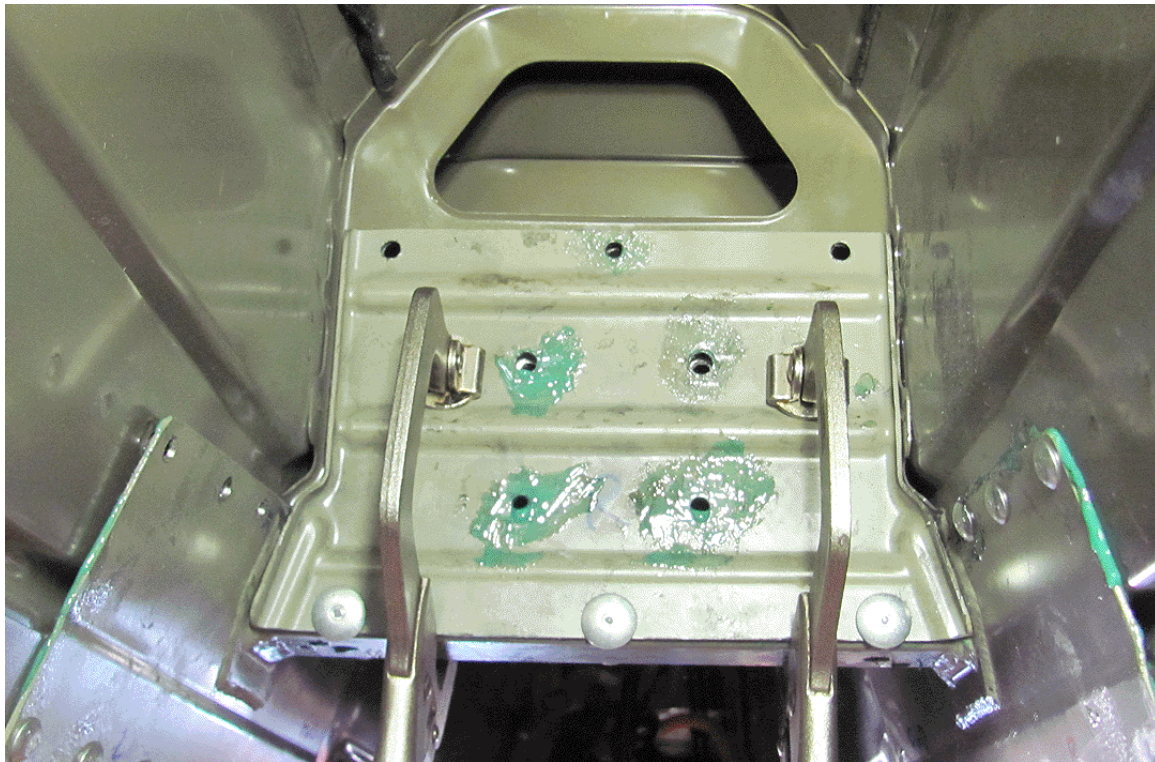

2756876

Caution: To ensure the pop rivets are installed correctly, use two hand clamps or “C” clamps to hold the plates into position. Make sure the rear plate is pressed against the vehicle body in each location as each rivet is being installed.

21. Re-locate the rear plate and install the 7 pop rivets (2), P/N 11561547, through the upper 6.75mm (17/64 in) holes. Make sure the rear plate is pressed against the vehicle body in each location as each pop rivet is being installed.
22. Re-locate the front plate and install 7 pop rivets (2), P/N 11561547, through the upper 6.75mm (17/64 in) holes. Make sure the front plate is pressed against the vehicle body in each location as each pop rivet is being installed.
23. Install the remaining 28 pop rivets (2), P/N 11561547, through the 6.75mm (17/64 in) holes of the reinforcement assembly. Make sure the reinforcement assembly is pressed against the vehicle body in each location as each pop rivet is being installed.

Note: The six longer rivets (3), P/N 11569698 are to be located in bottom of the front and rear plates.

24. Install the six pop rivets (3), P/N 11569698, through the lower 6.75mm (17/64 in) holes that were also drilled through the reinforcement assembly. Ensure the plate is pressed against the reinforcement assembly in each location as each pop rivet is being installed.
25. Grind flush any pop rivet mandrels that did not break off flush with the rivet head.
26. Wipe off any excess polyurethane that squeezed out around the reinforcement assembly or around the front and rear plates.

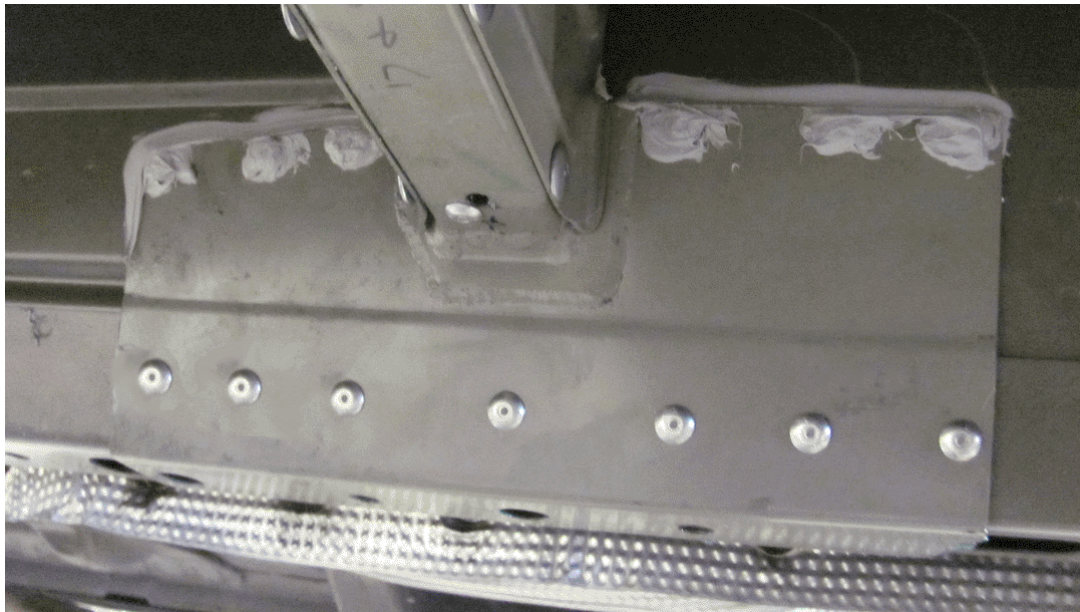

2756891

27. Apply RTV, P/N 88864346 (or equivalent), on and around each of the six upper rivet heads along each side of the reinforcement assembly. The other rivet head locations do not require sealer.

Caution: Remove and **discard** the four short M10 bolts from the reinforcement assembly. Discard the M10 and M8 bolts removed from the high-voltage battery. The battery tunnel reinforcement kit, PN 22920448, contains new M8 and M10 bolts. Use the new bolts to install the high-voltage battery to avoid vehicle damage.

28. Remove the four M10 bolts from the reinforcement assembly. Discard the M10 bolts.
29. Re-install and re-connect the high voltage battery using the 18 new M10 bolts, P/N 11588740, and four new M8 bolts, P/N 11588724, from the kit. Refer to Drive Motor Battery Replacement and Shipping in SI.
30. Lower the vehicle. Refer to *Lifting and Jacking the Vehicle* in SI.

HV Battery/Inverter Surge Tank Replacement and Coolant Level Sensor Jumper Harness Installation

1. Remove battery reservoir cap from coolant surge tank.

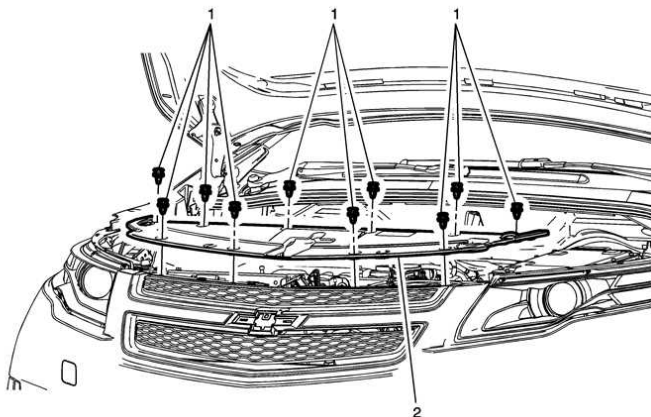

2393887

2. Remove front compartment sight shield.

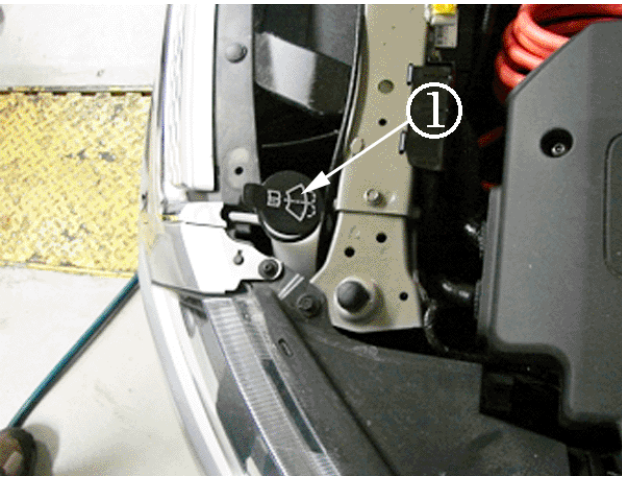

2757179

3. Remove windshield washer filler tube (1) by pulling up on it.

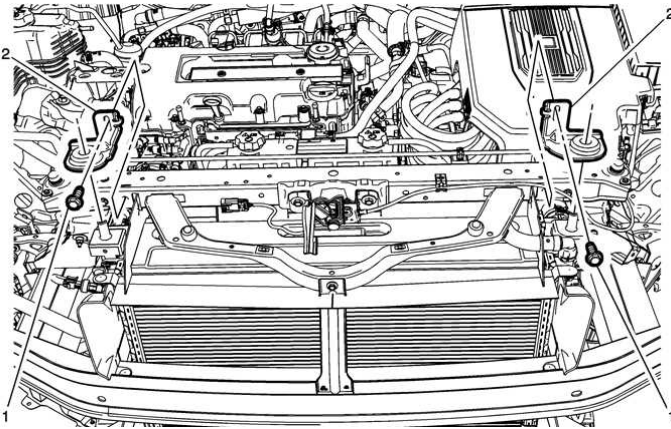

2417439

4. Remove radiator upper mounts (2).

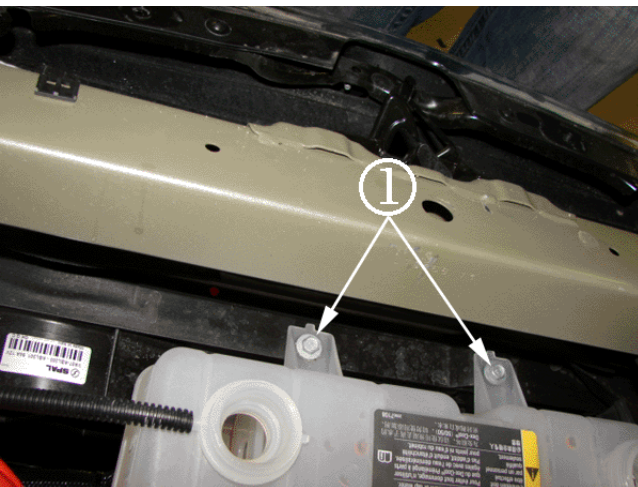

2757064

Caution: Do NOT use a prybar or similar tool to move the radiator module rearward, or damage to the radiator module can result.

Note: If accessing the surge tank-to-fan shroud fasteners is difficult, remove the radiator upper crossbar to gain access to the fasteners.

5. Push condenser/radiator/fan/module rearward and remove the two coolant surge tank fasteners (1).

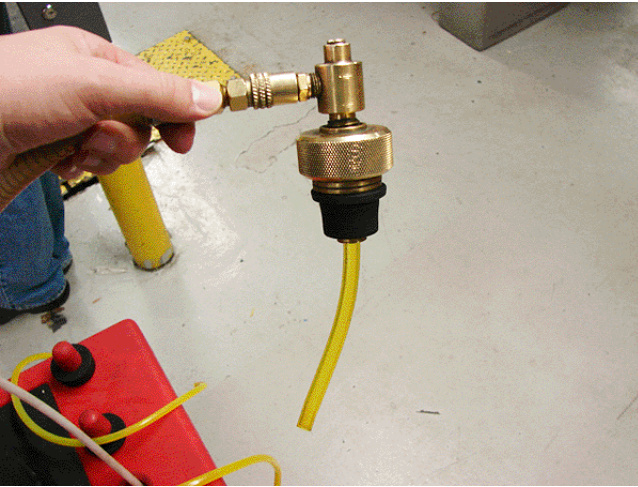

2757170

6. Empty the power inverter module cooling system reservoir using the Vac-N-Fill system with 152 mm (6 in) hose extension.
7. Clamp shut power inverter module cooling system reservoir hoses.



2757078

8. Disconnect all hoses for both reservoirs of the coolant surge tank. Remove the battery coolant pump inlet hose, battery coolant cooler outlet hose, battery radiator outlet hose and generator control module coolant tank hose.
9. Remove the coolant surge tank.
 - 9.1 Remove engine/intake cover.

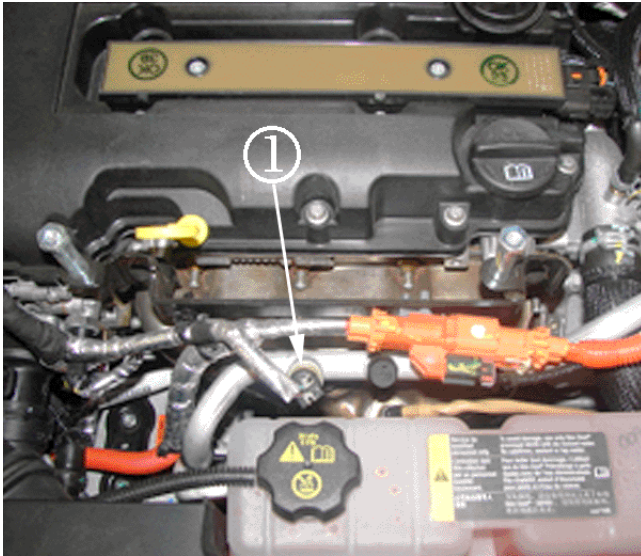

2756811

9.2 Remove A/C refrigerant pressure sensor connector (1).

9.3 Wiggle coolant surge tank out of engine compartment.

10. Install coolant level sensor jumper harness.

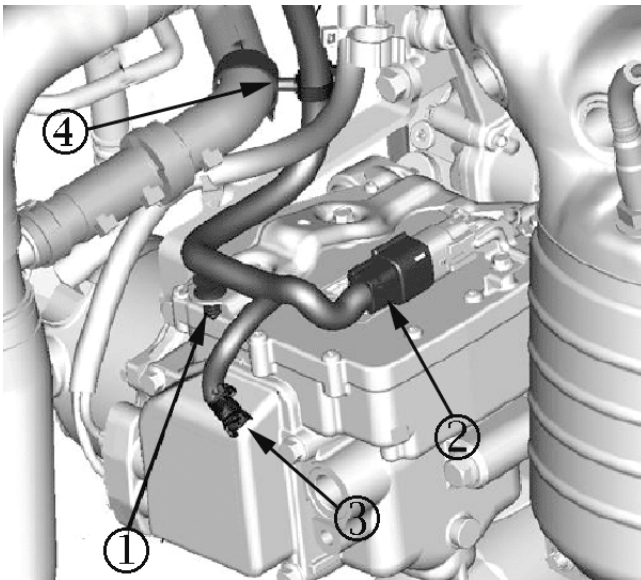

2757168

10.1 Unplug refrigerant temperature sensor (3).

10.2 Pull out the wire harness.

10.3 Unseat Christmas tree retainer (1).

10.4 Disconnect compressor connector (2).

10.5 Remove harness clip from hose (4).

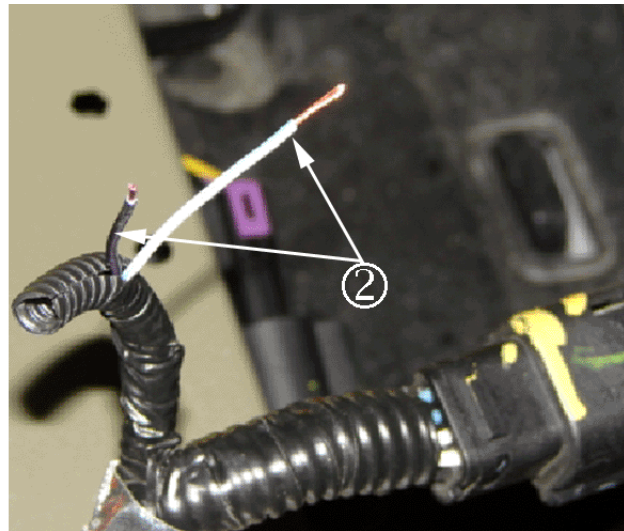

2757140

10.6 Cut off the wires at the back of the refrigerant temperature sensor (1) connector and strip 13 mm (1/2 in) of insulation from the two wire ends (2).

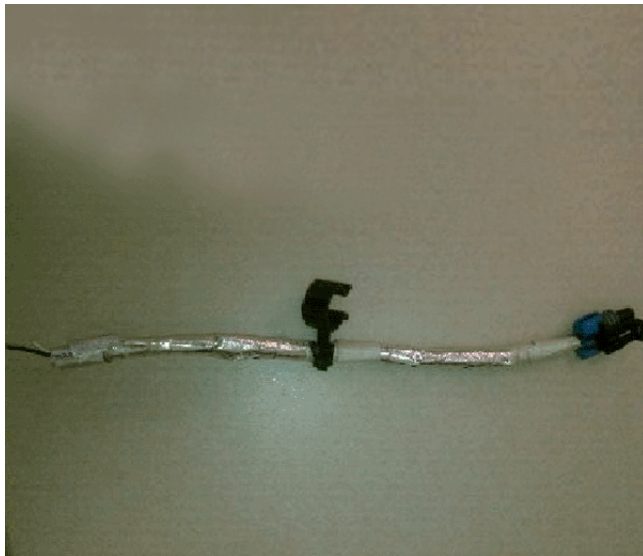

2757114

10.7 Locate the coolant level sensor jumper from service kit 19260759 and strip 13 mm (1/2 in) of insulation from the two wire ends.

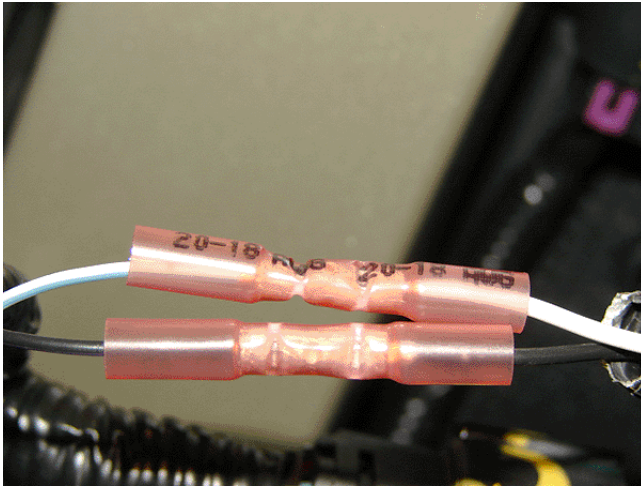

2757181

- 10.8 Crimp connect white and black wires on the new kit harness to the white/blue and black/violet wires respectively using the splice clip provided in the service kit. Refer to the instructions provided in the kit for proper procedure and tools.

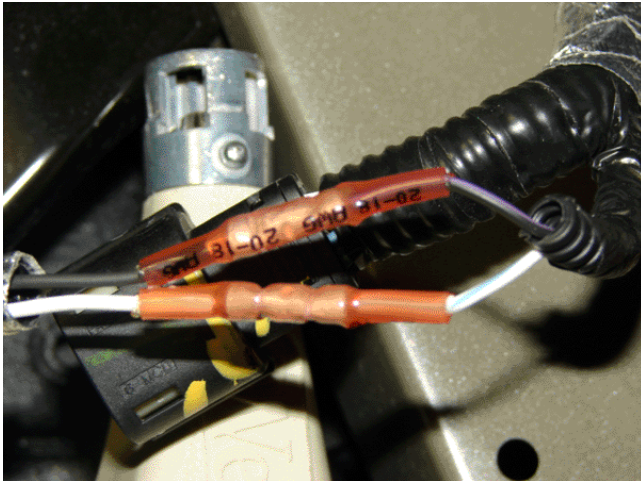

2757184

- 10.9 Apply heat to the splice clip/heat shrink to seal it to the wire insulation. Proper tools must be used to protect the wire insulation from excess heat.

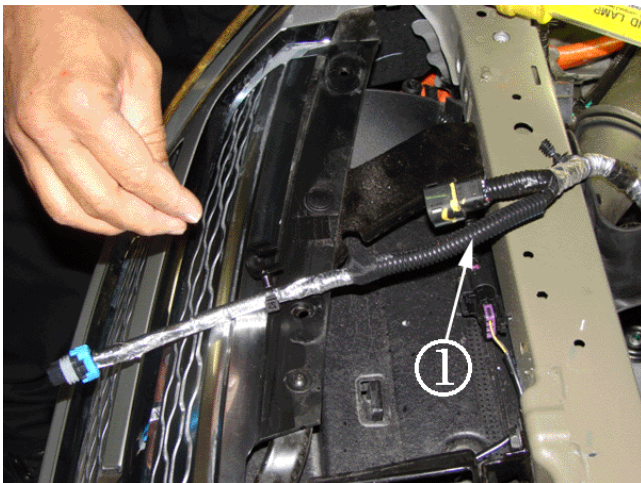

2757090

- 10.10 Install the new corrugated tube (1) that is provided in the service kit over the harness splice. The corrugated tube should overlap existing harness corrugated tube on both sides.

- 10.11 Completely wrap new corrugated tube with black electrical tape.
- 10.12 Reinstall the wire harness.
- 10.13 Install harness clip on hose in specified area.
- 10.14 Replug the compressor connector.
- 10.15 Reseat the Christmas tree retainer (replace if damaged).

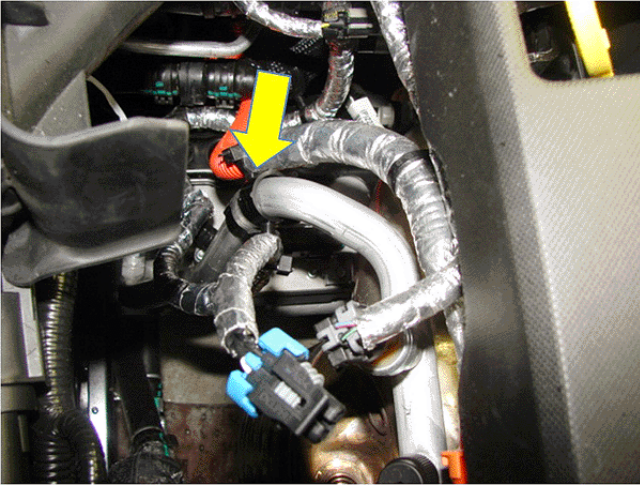

2757177

- 10.16 Install new harness clip (from the kit) on the A/C line above existing harness clip.

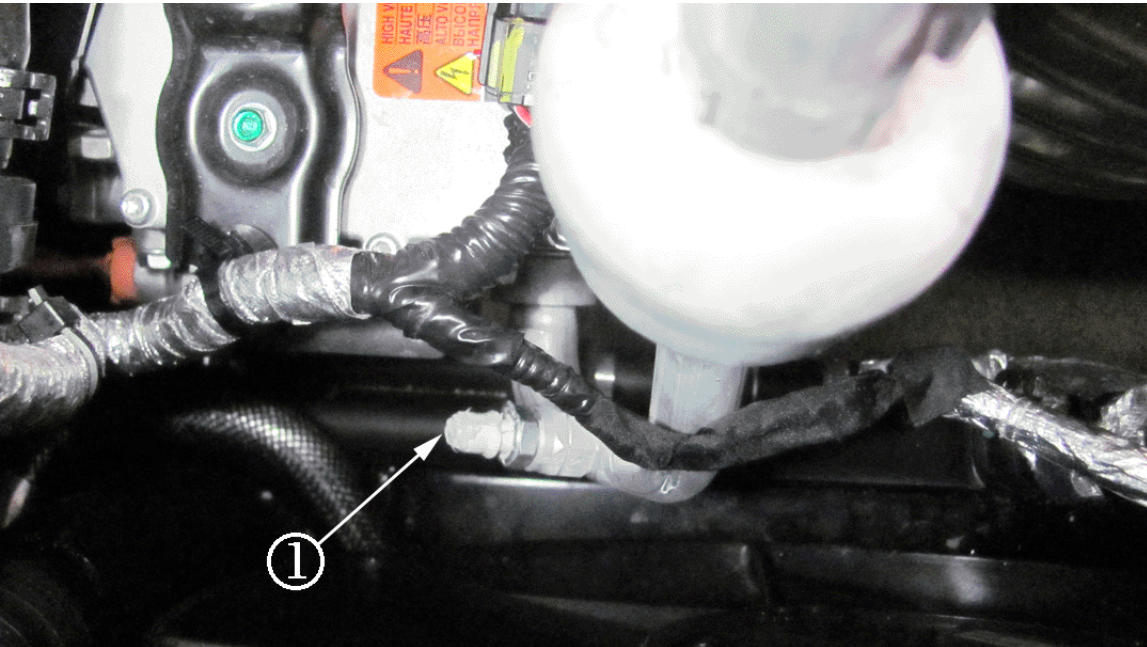

2757130

- 10.17 Put a dime-sized dab of RTV, P/N 88864346, (or equivalent) over exposed refrigerant temperature sensor (1) to cover exposed terminals.

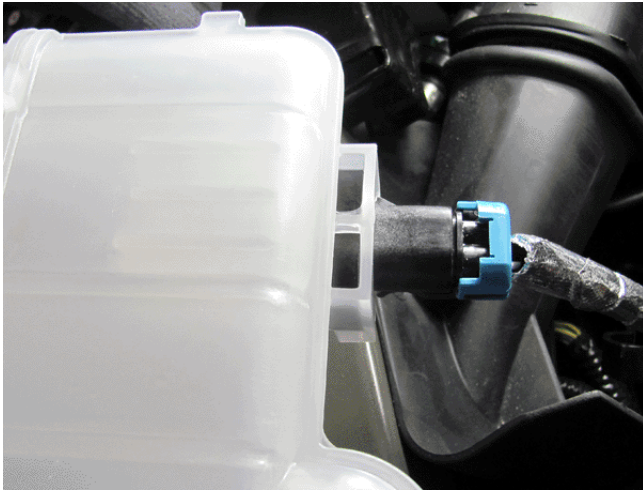

2757150

11. Install the new coolant surge tank.
12. Connect coolant level sensor to new coolant surge tank.
13. Reconnect all coolant surge tank hoses.
14. Push radiator toward the engine and secure the driver's side (left) mount coolant surge tank fastener (1) by installing and tightening the one bolt.
15. Reconnect A/C refrigerant pressure sensor connector.
16. Remove manual clamp from power inverter module cooling system reservoir hoses.

Note: Vac-N-Fill equipment must be used along with proper coolant. The Power Electronics / Charging and Battery Cooling systems require a 50/50 mix of DEX-COOL[®] and de-ionized water. This mixture is available in a pre-mix with bitterant, P/N 12378390 USA, P/N10953456, Canada. The pre-mixed coolant is no longer available without the bitterant chemical. Refer to P/I #PIP4910.

17. Vac-N-Fill the **power inverter module cooling system** reservoir.



2757171

- 17.1 Use the VAC-N-FILL equipment without the 152 mm (6 in) hose extension.

- 17.2 Pull vacuum (at least 15 in Hg) for five (5) minutes.
- 17.3 Fill while under vacuum.
- 17.4 Remove reservoir overflow port cap.
- 17.5 Install overflow tubing and reservoir cap.

Note: Vac-N-Fill equipment must be used along with proper coolant. The Power Electronics / Charging and Battery Cooling systems require a 50/50 mix of DEX-COOL[®] and de-ionized water. This mixture is available in a pre-mix with bitterant, P/N 12378390 USA, P/N10953456, Canada. The pre-mixed coolant is no longer available without the bitterant chemical. Refer to P/I #PIP4910.

18. Vac-N-Fill the **battery cooling system** reservoir.

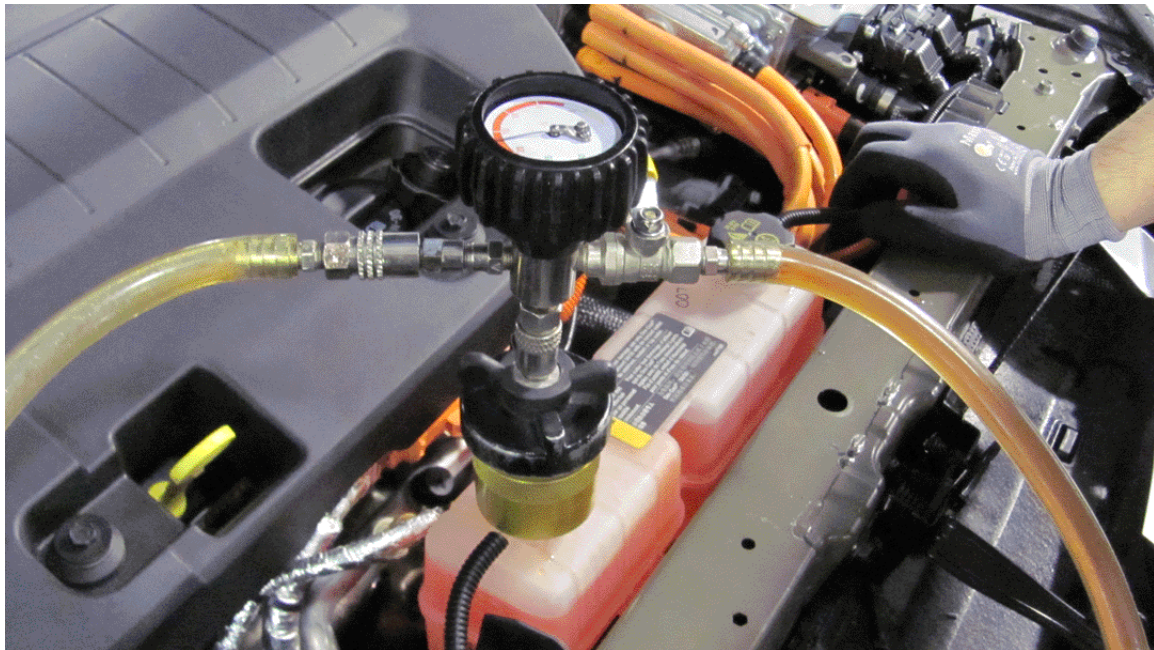

2757173

- 18.1 Use the VAC-N-FILL equipment without the 152 mm (6 in) hose extension.
- 18.2 Pull vacuum (at least 15 in Hg) for 5 minutes.
- 18.3 Fill while under vacuum.
- 18.4 Again pull vacuum (at least 15 in Hg) for 5 minutes.
- 18.5 Fill to top of reservoir.
- 18.6 Re-enable the high voltage battery. Refer to *Drive Motor Battery Replacement and Shipping* in SI.

Note: Do not attempt to order the calibration number from GM Customer Care and Aftersales. The calibration numbers required for this service procedure are programmed into control modules via a Multiple Diagnostic Interface (MDI) and TIS2WEB with the calibration update. When using the MDI for reprogramming, ensure that it is updated with the latest software version. Use **TIS2WEB on or after 02/10/12** to obtain the calibration. If you cannot access the calibration, call the Techline Customer Support Center and it will be provided.

For step-by-step programming instructions, please refer to SI and the Techline Information System (TIS) terminal.

19. Verify that there is a battery charge of 12 to 15 volts. The battery must be able to maintain a charge during programming. Only use an approved Midtronics® PSC 550 Battery Maintainer (SPS Programming Support Tool EL-49642) or equivalent to maintain proper battery voltage during programming.
20. Reprogram the modules listed in step 20.3. Refer to SI and Service Programming System (SPS) documentation for programming instructions.
 - 20.1 Connect the MDI to the vehicle. Connect the MDI to the programming terminal with a cable.
 - 20.2 Select J2534 MDI and Reprogram ECU from the Select Diagnostic Tool and Programming Process screen.

Note: Ensure that the hood is open and turn the vehicle ON to Service Mode. The Service Mode can be attained by pressing and holding the power button for 5 to 8 seconds WITHOUT depressing the brake pedal. Make sure that the ICE does not come on during this process.

- 20.3 Determine module year of vehicle.

Note: For 2011 vehicles, ensure that the most recent version of field action bulletin 11137 has been completed BEFORE performing the programming event in this bulletin.

- For 2011 model year vehicles, select SEQ Programming Sequence Battery Energy Control Module (K15) and Hybrid Powertrain Control Module 2 (K114B) from the Supported Controllers screen.
 - For 2012 model year vehicles, select Hybrid Powertrain Control Module 2 (K114B) from the Supported Controllers screen.
- 20.4 Follow the on-screen instructions.

Caution: The Coolant level will drop below reservoir during this process. If it does, do not break vacuum, but use the Vac-N-Fill equipment to fill the reservoir. Next, re-establish the 15 in Hg vacuum for the remainder of the fill procedure. You may have to fill the reservoir several times during this procedure to prevent a low coolant condition, which will induce air into the system. If at the end of the procedure, the fluid level is below the reservoir, fill the reservoir and repeat the MDI/GDS Hybrid/EV Battery Pack Coolant Pump Bleed Procedure.

21. Run MDI/GDS2 “Hybrid/EV Battery Pack Coolant Pump Bleed Procedure” test **while maintaining the 15 in Hg vacuum throughout** the process. This procedure will take about an hour to complete.
 - 21.1 Launch GDS2 and select Diagnostics.
 - 21.2 Ensure information is accurate on the Vehicle Selection screen and then press ENTER.
 - 21.3 Select Module Diagnostics and then press ENTER.
 - 21.4 Select Hybrid Powertrain Control Module 2 and then press ENTER.
 - 21.5 Select Control Function and then press ENTER.
 - 21.6 Select Hybrid/EV Battery Pack Coolant Pump Bleed Procedure and then press ENTER.
 - 21.7 Adjust (remove or add) coolant level to max fill line.
 - 21.8 Install overflow tubing and reservoir cap.
22. Clear diagnostic codes (DTCs) if necessary.
23. Disconnect the low voltage battery charger.
24. Turn vehicle off.

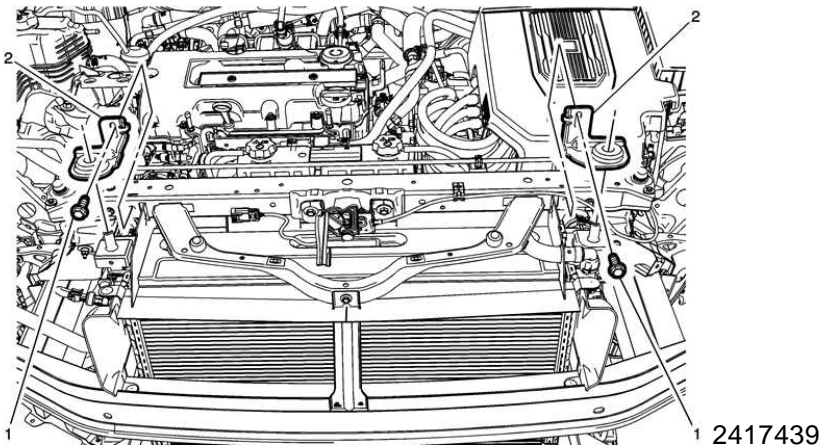

25. Reinstall radiator mounts (2). Tighten bolts to 22 Nm (16 lb-ft).

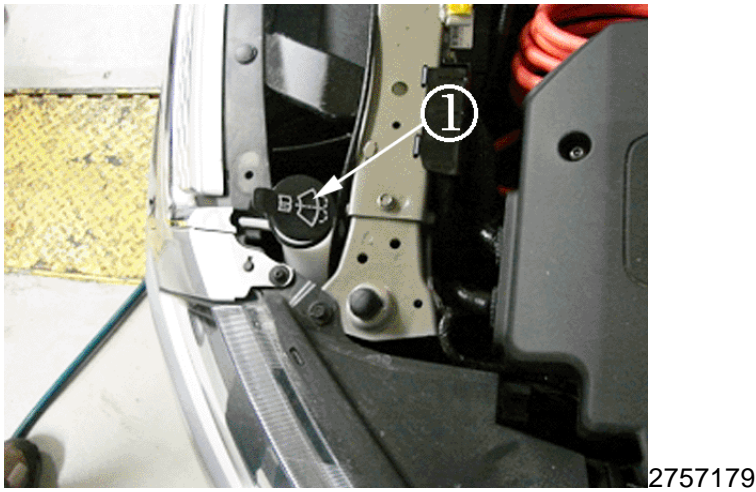

- 26. Reinstall windshield washer filler tube (1).
- 27. Reinstall engine/intake cover.
- 28. Road test the vehicle in Mountain Mode with the vehicle in Low Gear for approximately 5 miles (8 km). When performing the 5 mile (8 km) mile drive cycle, drive vehicle in slalom (side to side motion) to purge any remaining air.

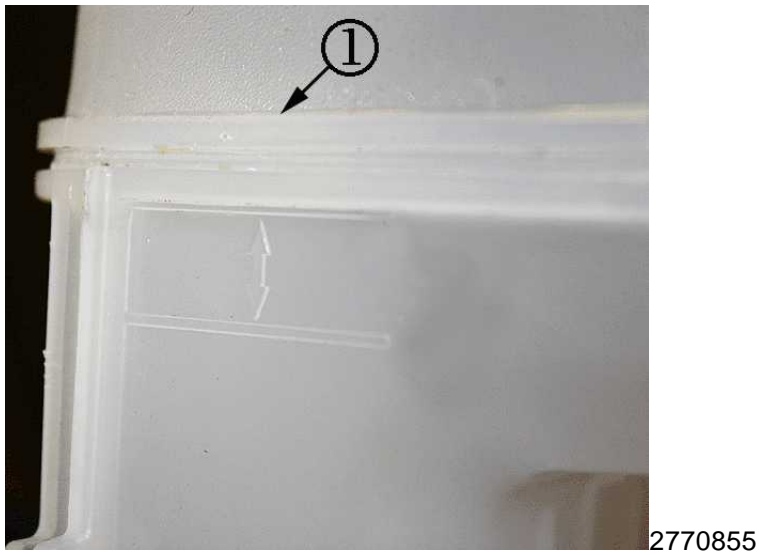

- 29. Re-check coolant level. Ensure the coolant level is to the top of the tank seam (1).

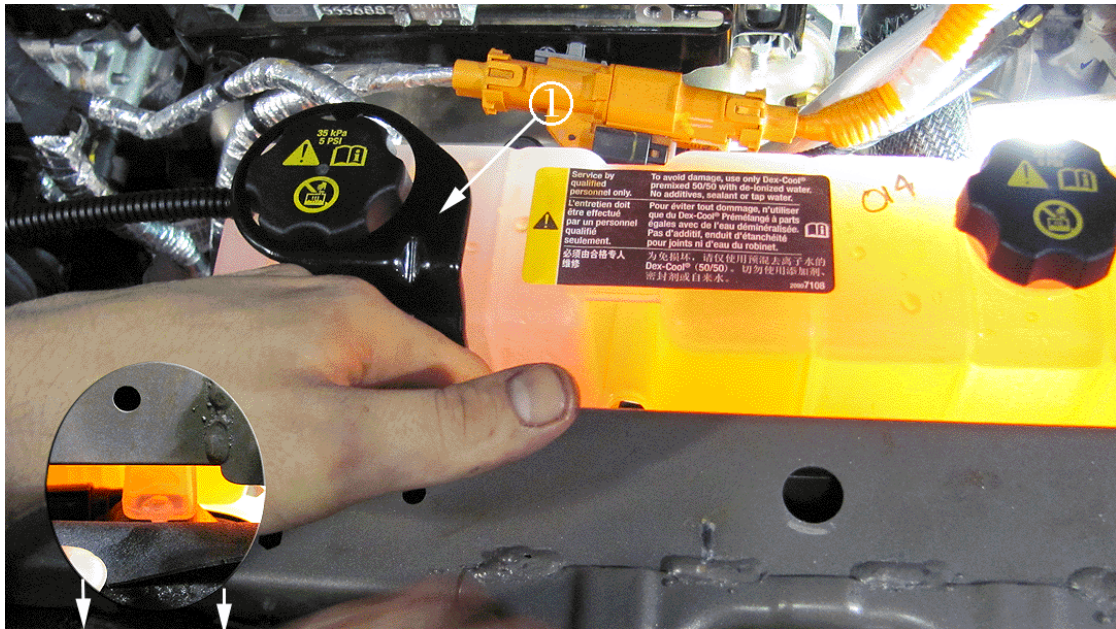

2757164

30. Install locking bracket (1) on vehicle right side reservoir securing the bracket and the reservoir with the bolt provided in the kit. Tighten bolt from front side of tie bar.

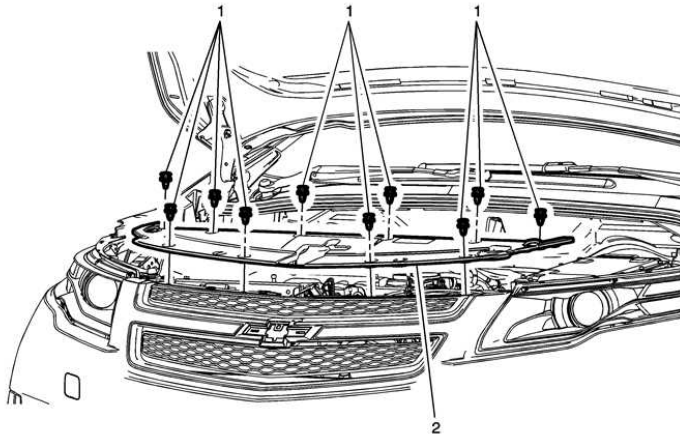

2393887

31. Reinstall front compartment sight shield.
 32. Wash the vehicle.
 33. Fill the fuel tank.
 34. Check tire pressure. Add air to tires if required.
 35. Fully charge the high-voltage battery before returning the vehicle to the customer.

COURTESY TRANSPORTATION – For US and Canada

The General Motors Courtesy Transportation program is intended to minimize customer inconvenience when a vehicle requires a repair that is covered by the New Vehicle Limited Warranties. The availability of courtesy transportation to customers whose vehicles are within the warranty coverage period and involved in a product program is very important in maintaining customer satisfaction. Dealers are to ensure that these customers understand that shuttle service or some other form of courtesy transportation is available and will be provided at no charge. Dealers should refer to the General Motors Service Policies and Procedures Manual for Courtesy Transportation guidelines.

WARRANTY TRANSACTION INFORMATION

Submit a transaction using the table below.

Labor Code	Description	Labor Time	Net Item
V2533	Install Battery Reinforcement Brkt, Coolant Sensor, Coolant Tank	7.0	*
T5848	Battery Charge, Tire Inflate, Vehicle Wash, & if applicable, Fill Tank	0.7	**

* Submit the cost of the adhesive required to perform the repair, not to exceed \$29.70 USD, \$32.60 CAD, plus shipping.

** Submit the cost to fill the fuel tank in the Misc field.

CUSTOMER NOTIFICATION – For US and Canada

General Motors will notify customers of this program on their vehicle (see copy of customer letter included with this bulletin).

CUSTOMER NOTIFICATION – For Export

Letters will be sent to known owners of record located within areas covered by the US National Traffic and Motor Vehicle Safety Act. For owners outside these areas, dealers should notify customers using the attached sample letter.

DEALER PROGRAM RESPONSIBILITY

All unsold new vehicles in dealers' possession and subject to this program must be held and inspected/repared per the service procedure of this program bulletin before customers take possession of these vehicles.

Dealers are to service all vehicles subject to this program at no charge to customers, regardless of mileage, age of vehicle, or ownership, from this time forward.

Customers who have recently purchased vehicles sold from your vehicle inventory, and for which there is no customer information indicated on the involved vehicle listing, are to be contacted by the dealer. Arrangements are to be made to make the required correction according to the instructions contained in this bulletin. A copy of the customer letter is provided in this bulletin for your use in contacting customers. Program follow-up cards should not be used for this purpose, since the customer may not as yet have received the notification letter.

In summary, whenever a vehicle subject to this program enters your vehicle inventory, or is in your facility for service in the future, you must take the steps necessary to be sure the program correction has been made before selling or releasing the vehicle.



(Letter for customers with 2011 MY vehicles - US Only)

February 2012

Dear Volt Customer:

GM is now ready to implement the Volt vehicle enhancements that you were informed of in January.

We will be making enhancements to the battery coolant system and vehicle structure. Specifically, your Chevrolet dealer will add a reinforcement bracket to further protect the battery pack in a severe side collision, replace the battery coolant system reservoir with a new reservoir that includes a sensor to monitor the coolant level, reprogram the high voltage battery diagnostic module to allow for low coolant sensing, and add a tamper-resistant bracket to the top of the battery coolant reservoir to help prevent potential coolant overfills. This service will be performed at no charge.

In the fall of 2011, a software update was made available to you through Customer Satisfaction Program 11137. This updated software is required to perform the service above. If your vehicle does not already have this updated software, it will be installed for you at the same time, again, at no charge. Your vehicle's estimated electric vehicle range displayed in the instrument cluster will be reset. This will not affect your actual electric vehicle range. Within a short period of time, the displayed electric vehicle range will adjust to reflect an estimate more consistent with your normal driving range.

We recommend that you contact your dealer at your convenience to schedule an appointment on or after March 19. Upon request, your dealer will also provide you with courtesy transportation while your vehicle is at the dealership.

If you have any questions that your dealer is unable to answer, please contact your Volt advisor. The contact information is 877-4-VOLT-INFO (877-486-5846) or Voltda101@gmexpert.com.

We want you to know that we will do our best, throughout your ownership experience, to ensure that your Chevrolet Volt provides you many miles of enjoyable driving.



Alicia Boler-Davis
U.S. Vice President
Customer Experience

(Letter for customers with 2012 MY vehicles - US & Canada Only)

February 2012

Dear Volt Customer:

GM is now ready to implement the Volt vehicle enhancements that you were informed of in January.

We will be making enhancements to the battery coolant system and vehicle structure. Specifically, your Chevrolet dealer will add a reinforcement bracket to further protect the battery pack in a severe side collision, replace the battery coolant system reservoir with a new reservoir that includes a sensor to monitor the coolant level, reprogram the high voltage battery diagnostic module to allow for low coolant sensing, and add a tamper-resistant bracket to the top of the battery coolant reservoir to help prevent potential coolant overfills. This service will be performed at no charge.

Your vehicle's estimated electric vehicle range displayed in the instrument cluster will be reset. This will not affect your actual electric vehicle range. Within a short period of time, the displayed electric vehicle range will adjust to reflect an estimate more consistent with your normal driving range.

We recommend that you contact your dealer at your convenience to schedule an appointment on or after March 19. Upon request, your dealer will also provide you with courtesy transportation while your vehicle is at the dealership.

If you have any questions that your dealer is unable to answer, please contact your Volt advisor. The contact information is 877-4-VOLT-INFO (877-486-5846) or Voltda101@gmexpert.com.

We want you to know that we will do our best, throughout your ownership experience, to ensure that your Chevrolet Volt provides you many miles of enjoyable driving.

11342-2



Alicia Boler-Davis
U.S. Vice President
Customer Experience