



Service Bulletin

PRELIMINARY INFORMATION

Subject: Retrofit Procedure for New Corded Folding Top Cover Installation to Original Design Frame

Models: 2011-2012 Chevrolet Camaro Convertible

Attention: Before starting this retrofit procedure, ensure Customer Satisfaction #12052A has been performed on the vehicle. For additional help, it is recommended that the technician review a copy of this retrofit procedure along with viewing the Camaro Convertible Top Cover Retrofit Procedure training course #12040.32V (U.S.). A training course is being developed for Canada and will be posted to the GM Canada LMS site (www.gmprocanada.com) as soon as available.

This PI is being revised to provide updated repair information. Please discard PI0756A.

Condition/Concern

The replacement folding top cover is a different design from the original top installed in production. The new design folding top cover contains six control cords (three each side), which were not part of the original design cover. Holes will need to be drilled into each side of the folding top frame accept the rivets that will retain these cords.

The instructions below are steps for removal of the top assembly from the vehicle, removal of the top cover, drilling the additional holes and installation of the new top cover including routing of the color keyed control cords.

Important: The three cords added to each side of the top cover are color-keyed with paint dots on the cord eyelets only. The white, yellow and orange colors were added to the graphics below to represent the color-key of the eyelets. The headliner cord was shown in red for illustration purposes only; the end eyelet of the headliner cord DOES NOT have a color-key designation.

Inboard/Left Side View of Cord Routing and P-Clip, Eyelet and Straps Orientation

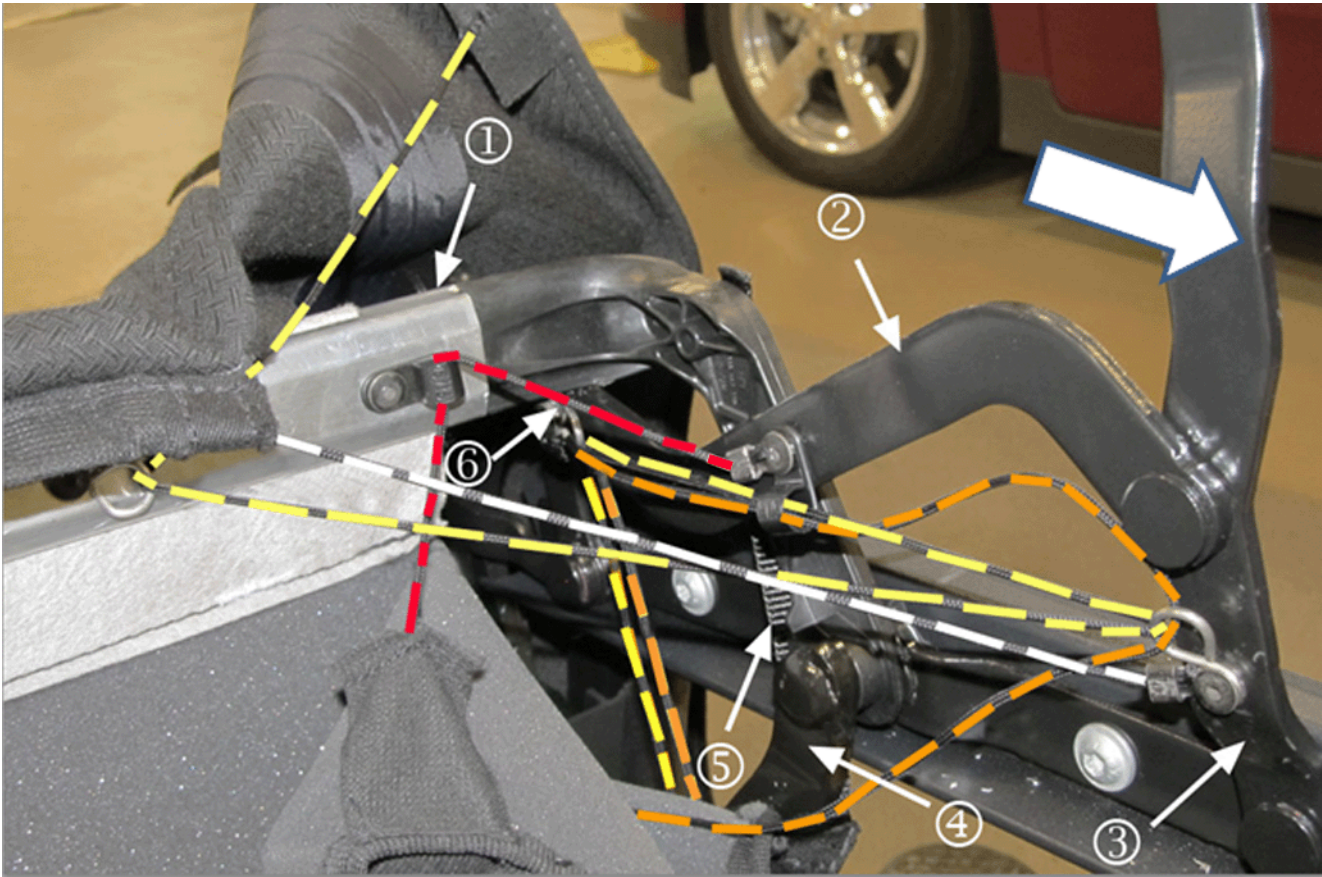

Outboard/Left Side View of Cord Routing and P-Clip, Eyelet and Straps Orientation

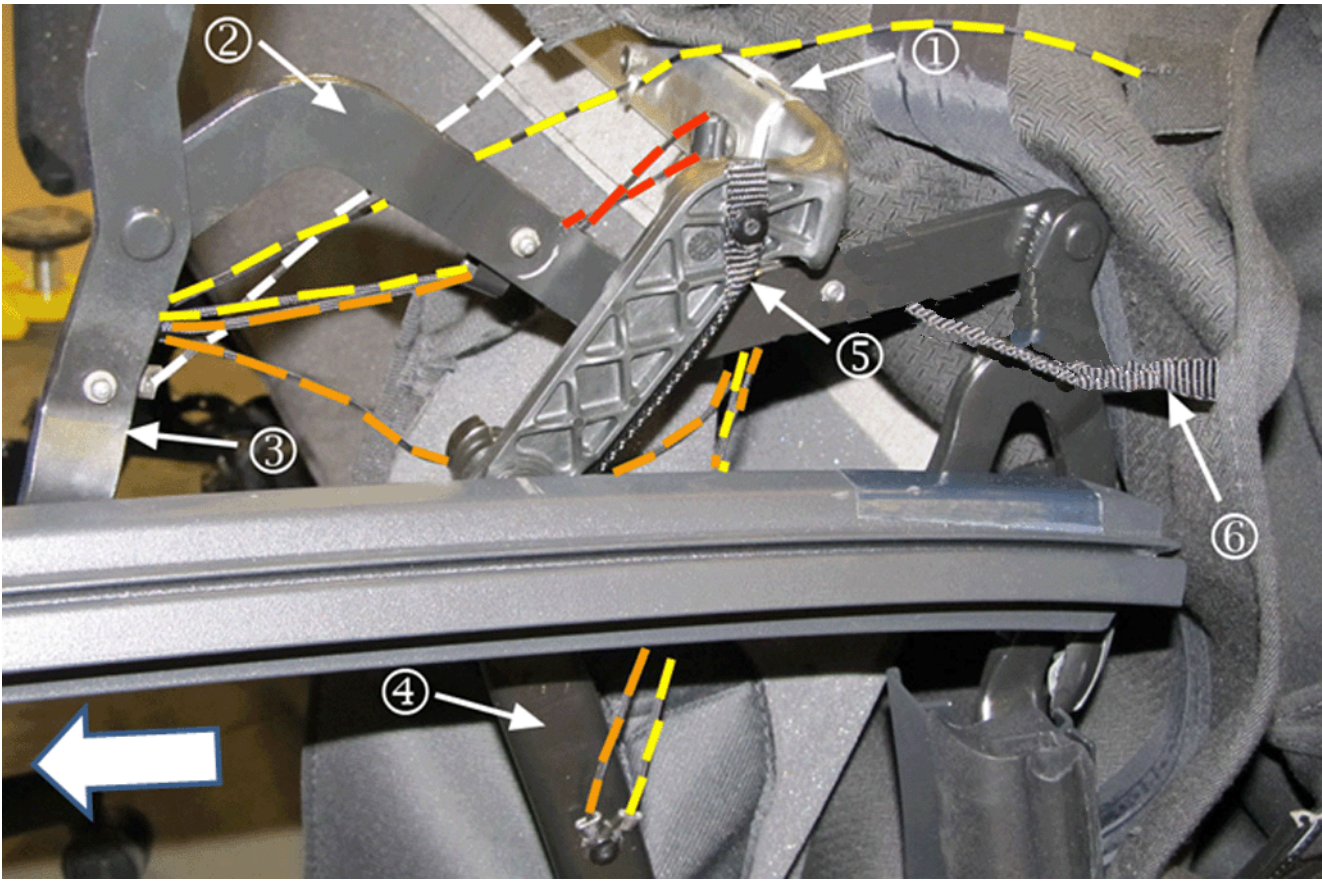

Note: The graphics above are views with the top in mid-open position and the right side views would mirror the left. The top frame links and strap callouts referenced later in the instructions are noted in the key below.

Key to Call-outs Noted Above

- (1) #2 Bow
- (2) Control Link
- (3) Rear #1 Bow Link
- (4) Balance Link
- (5) Headliner Strap
- (6) Rear Top Cover Strap

Recommendation/Instructions

Recommendations

- Read these instructions from beginning to end, including a review of any kit supplied instructions/appendices, before starting the retrofit.
- All the steps in this instructions are documented on the drivers side of the vehicle, unless noted otherwise.
- When adding holes to the frame or riveting the cords/straps of the new top cover in place, complete each step on both sides of the top before moving on to the next step.
- For the additional holes drilled in the frame during the retrofit, drill bit size is critical for proper retention of the rivets. A 13/64" bit should be used for the 5 mm (0.197 in) holes and a 1/8" bit should be used for the 3.2 mm (0.125 in) holes.

Instructions

1. Remove the convertible top assembly from the vehicle. Refer to Folding Top Frame Replacement in SI.



2. Place the convertible top on a clean tarp or other clean, dry, suitable surface with the top cover facing downward as shown above.
Note: When drilling out any existing rivets on the top cover or headliner, use a punch to mark a spot for drilling, at the top center of the old rivet.
3. Start removal of the old top cover at the #1 bow, looking at the inside of the top. Remove the front edge retainer, rail guides, top handle post garnish, flipper doors, and loosen the headliner as necessary. Refer to Folding Top Cover Replacement in SI.
Important: Removing the #5 bow assembly IS NOT necessary for the top cover retrofit. The #5 bow assembly and water management bar should stay attached to the folding top frame during the entire retrofit.
Note: The headliner should remain attached to the #3 bow, and all rearward bows, during this top cover replacement procedure.
4. Release the headliner retaining bead around the rear window, remove the rear window pivot bracket nuts, and disconnect the defogger connectors. Refer to Folding Top Cover Replacement in SI.



5. Position the folding top on the floor, sitting upright in the mid-open position with the 1 bow supported by a suitable support as shown above



Note: The fore/aft control cords were removed on the new top cover design. During reassembly, attachment to the 1 bow does not occur as in the previous design.

6. Start removing the top cover from the #1 bow exposing the entire top side of the #1 bow casting. Remove the large header garnish molding by accessing the fasteners from the top side of the #1 bow. Disassemble the headliner from the #1 bow and disconnect the top cover fore/aft control cords from the #1 bow. Drill out the top cover side strap rivets attached to the rear #1 bow link and control links. Refer to Folding Top Cover Replacement in SI.

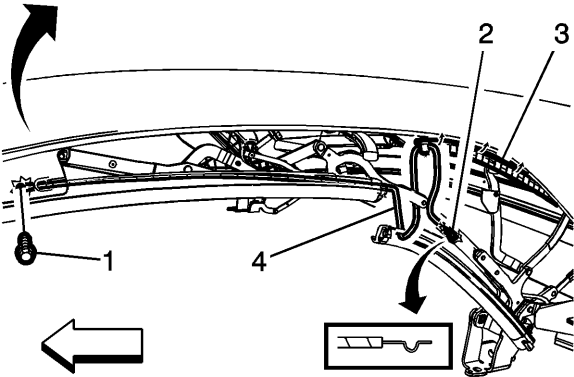
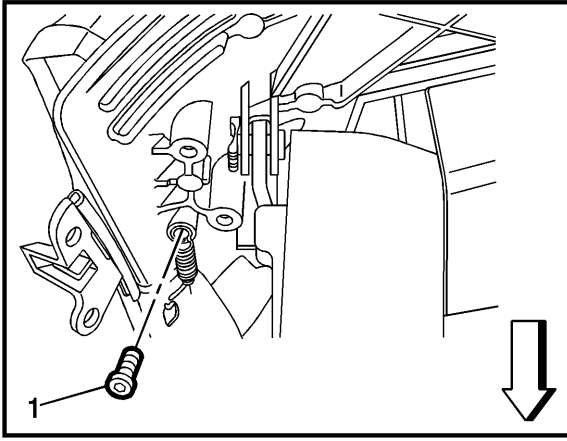

7. Remove the left and right side tension cables from the top cover and the rear side rail weatherstrips following the steps below. If additional detail is needed, refer to Folding Top Cover Side Tension Cable Replacement in SI.
 - 7.1. Remove the left front side tension cable spring retaining screw from the #1 bow.
 - 7.2. Feed the side tension cable and spring out of the top cover material.
 - 7.3. Pull the top cover edge plastic retainer out of the channel on the left rear side weatherstrip rail. Start at the bottom and work your way upward.
 - 7.4. Peel the left rear side weatherstrip out of the rail so there is access to the side tension cable.
 - 7.5. Remove the piece of tape holding the tension cable end into the side rail link hole.
 - 7.6. Remove the side tension cable anchor from the rear side rail.
 - 7.7. Pull the cable back through the weatherstrip so it is free and clear of everything.
 - 7.8. Repeat the same operation on the opposite side.



Note: Due to top cover replacement, the fabric connecting the top cover beads to the cover can be cut for quicker removal. DO NOT cut any of the headliner beads.

Important: Mark the #2 bow to show that the top cover bead is installed in the front slot and the headliner bead is installed in the rear slot. Note that the beads alternate front and rear position on each bow going rearward.

8. Starting at the #2 bow working rearward, remove the top cover from the bows by cutting the fabric connecting the top cover retaining beads to the cover. After cutting the fabric, slide the beads out of the bows.



9. Remove the 5 bow seal and release the top cover retainer from the 5 bow. The old top cover can now be lifted away from the top frame.

Early Design #2 Bow Bracket

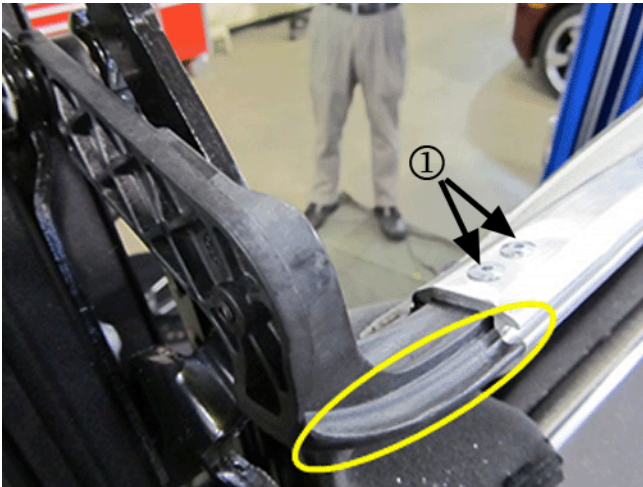

Current Design #2 Bow Bracket



Important: The #2 bow end brackets are made of plastic and will likely break/snap during removal. Two new brackets are included with the top cover replacement kit. Regardless of breakage, all early design #2 bow brackets should be replaced.

10. Remove the #2 bow from the top frame assembly following the steps below:

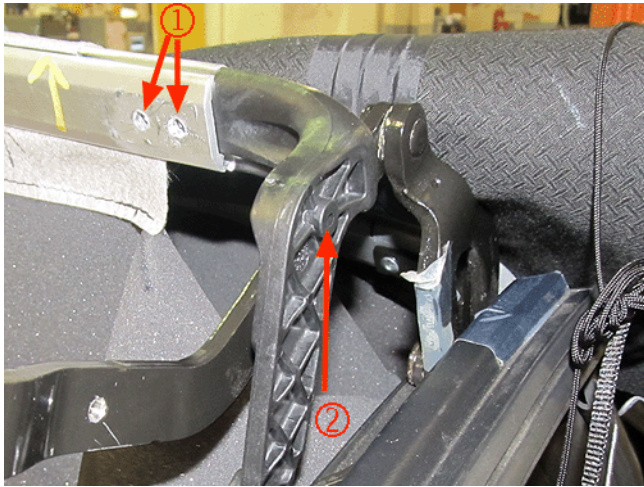

10.1. Drill out the rivets (1) that hold the #2 bow brackets to each end of the #2 bow (two rivets per side), and remove the D-link from the headliner cord on each side.

10.2. If still attached, slide the headliner retaining bead out of the #2 bow and drill out the rivet (2) retaining the side headliner straps to each side #2 bow bracket.

Note: Make sure to retain the thrust washers and bushings from disassembly of the #2 bow brackets and balance links. However, if parts are lost, extras are included in the top cover replacement kit.

10.3. With the aid of an assistant, technicians should stand on each side of the car, simultaneously holding the #2 bow with one hand and pulling outward on the #2 bow brackets with the other hand. Gradually increase the pull force until the #2 bow bracket is disengaged from the #2 bow.

10.4. Set aside the #2 bow for holes to be added in step #12.



10.5. Remove the retaining clips holding the #2 bow brackets to the balance link pins, and work the bushing and bracket out of the linkage on each side. Pull inboard at the top of the balance link to disengage the pin and leave it disengaged until later in the retrofit procedure.

Important: For ALL additional holes drilled, drill bit size is critical for proper retention of the rivets. A 13/64" bit should be used for the 5 mm (0.197 in) holes and a 1/8" bit should be used for the 3.2 mm (0.125 in) holes. All holes/rivets will be 5 mm (0.197 in) in size except for the single hole added to the left and right balance link, which is 3.2 mm (0.125 in).

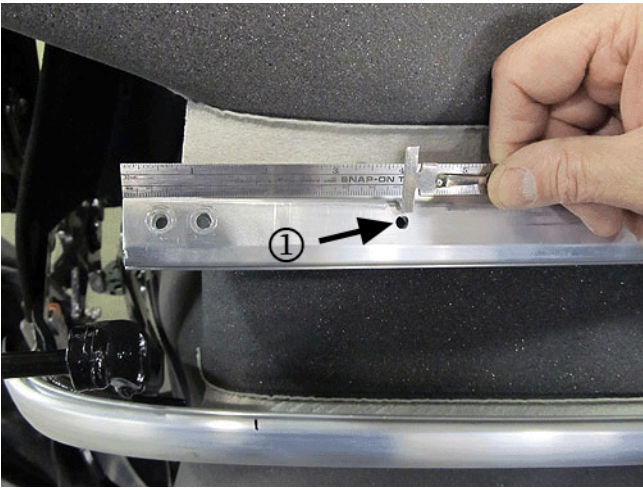

Important: The two holes added to the #2 bow should be centered on the bow and ARE NOT through holes. DO NOT drill through to the topside of the #2 bow.

11. While the #2 bow is removed, drill two 5 mm (0.197 in) holes (1) in the underside of the #2 bow. Position the holes 102 mm (4.0 in) from each end of the bow.



12. Centered on the left rear #1 bow link, drill a 5 mm (0.197 in) hole (1) into the link, positioned 35 mm (1.375 in) (3) from the center of the link pivot (2). Repeat the same operation on the opposite side of the top.

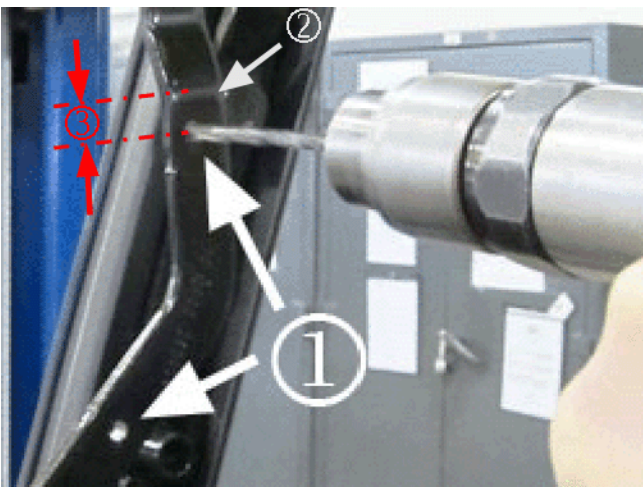

Note: Older convertible tops may be missing the upper 3.2 mm diameter hole shown in the control link above. If the hole is missing, add by drilling a new 5 mm (0.197 in) hole positioned 10 mm (0.40 in) (3) from the bend radius (2). Repeat the same operation on the opposite side of the top.

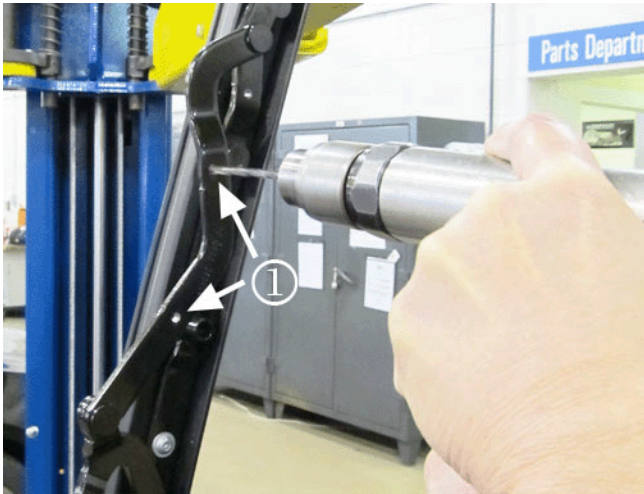

13. Re-drill the two existing 3.2 mm (0.125 in) holes (1) in the left control link to open the diameter up to 5 mm (0.197 in). Repeat the same operation on the opposite side.

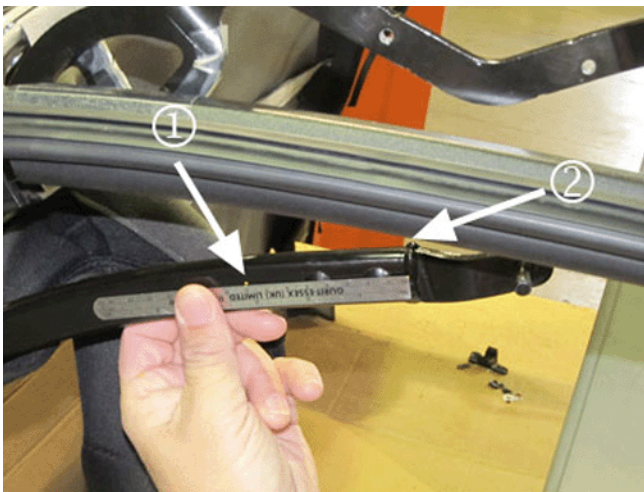

Important: The holes added to the each balance link are on the outboard side of the link and ARE NOT through holes. DO NOT drill through to the inboard side of the balance link. The right side balance link is shown in the graphic above.

14. Centered on the outboard side of the right balance link (1), drill a new 3.2 mm (0.125 in) hole, positioned 80 mm (3.15 in) from the center weld bead (2). Repeat the same operation on the opposite side.

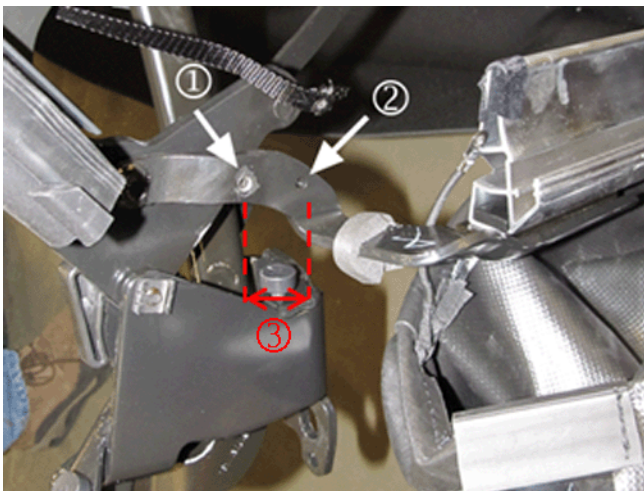

15. The graphic above shows the left #5 bow bracket with the strap and cords removed, and also the orientation of the new hole (1) and existing hole (2) for illustration purposes only.

15.1. Drill a 5 mm (0.197 in) hole into the left and right #5 bow brackets, positioned 30 mm (1.12 in) (3) from the hole where the rear headliner strap and water management bag cord are attached.

15.2. Drill out the original rivet retaining the strap and cord for repositioning those to the new hole.

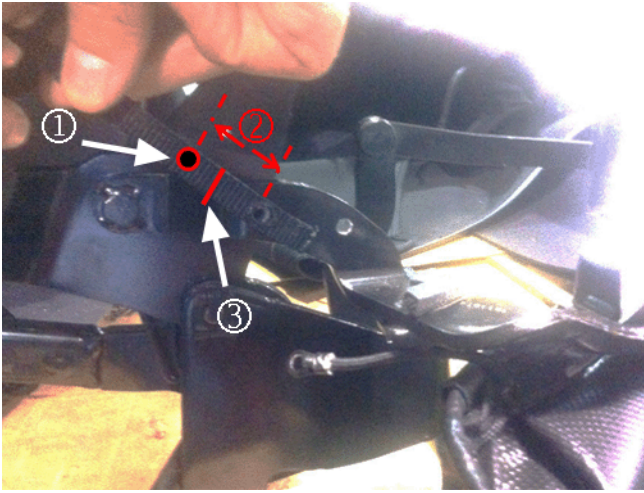

Important: The headliner strap, top cover cord and water bag cord will be installed to the #5 bow bracket later, in step #23.

15.3. The graphic above shows the headliner strap, which is attached to the 5 bow bracket. If the top being retrofitted does not have a new 5 bow bracket equipped with the new hole, then using a hot mandrel, or equivalent tool, burn a new hole (1) into the headliner strap. As shown above, locate the new hole 30 mm (1.20 in) (2) from the current location, then cut the reworked headliner strap at call out #3.



16. Lay out the new corded top cover on a clean, protected surface.



Important: Trial fit the top cover retaining beads into their corresponding roof bows. If installation is extremely difficult, it may be necessary to remove material from all of the beads, prior to their full installation. Use sand paper, or equivalent, to remove material from the tops of the beads to reduce/eliminate interference.



17. Starting from the passenger side, position the top cover beads to the beveled edge at the end of each bow.
18. With the aid of an assistant, alternately feed the beads into the slots on roof bows #3, #3.5 and #4. Continue to work the beads across to the opposite side until all the top cover beads are centered on the roof bows.

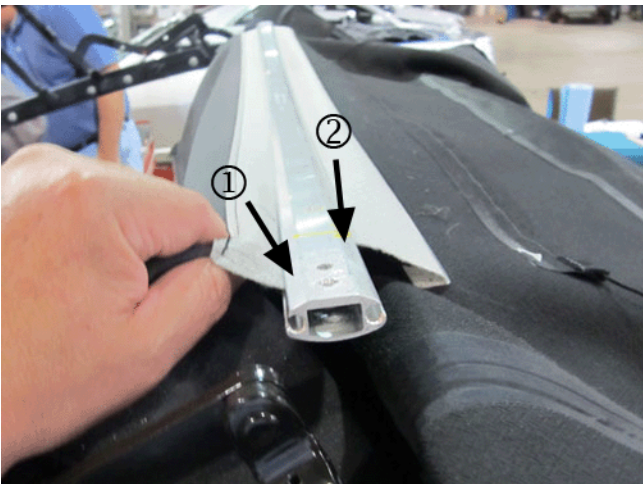

Note: As marked during the removal earlier, the headliner bead goes in the rear #2 bow slot (1) and the top cover bead goes in the front # bow slot (2).

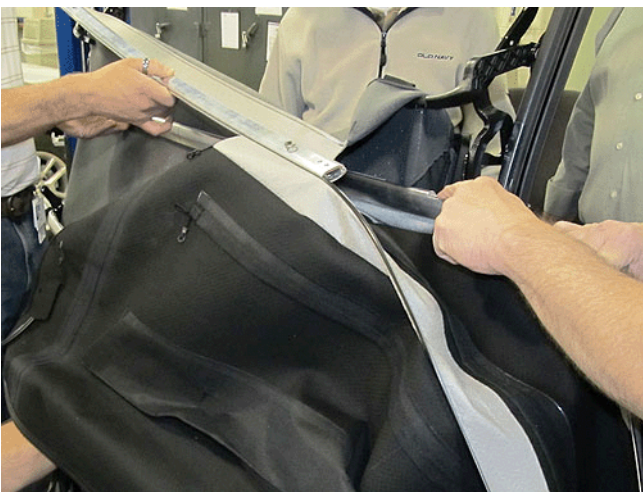

19. Slide the reworked #2 bow onto the headliner and new top cover beads **at the same time** as shown above.



20. Reassemble the #2 bow bracket bushings (1), new plastic thrust washers, then the retaining clips. With the aid of an assistant, install the #2 bow brackets to the #2 bow, while simultaneously angling the brackets into position on the linkage on each side.



21. Ensure the brackets are fully seated on the #2 bow and install only the outboard rivets on the left and right side at this time.



22. Reinstall the balance link pins, install the plastic thrust washers, then the retaining clips on each side.

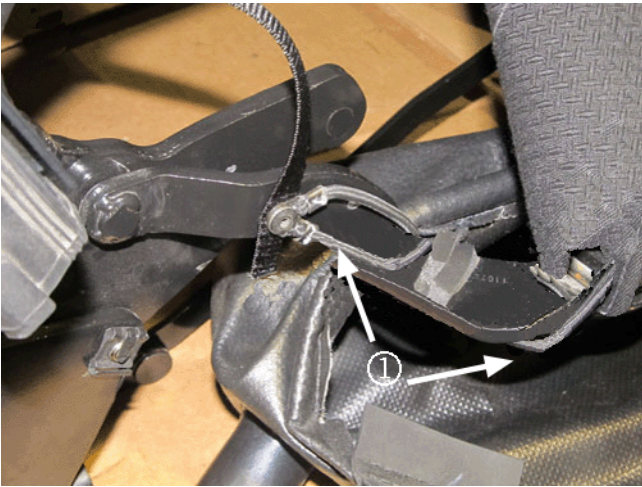

Important: Ensure that the top cover #5 bow bracket cord (1) is routed underneath the bracket.

23. Rivet the new top cover #5 bow bracket cord (1) to the new holes on the left and right #5 bow brackets, along with the water bag cord and 1 headliner control strap as shown above.
24. Install the rear window pivot bracket nuts, connect the defogger connectors, reinstall the headliner bead around the rear window, and secure the top cover to the #5 bow. Refer to Folding Top Cover Replacement in SI.
25. Reroute the side tension cables through the rear side rail, rear weatherstrip and top cover on each side following the steps below. If additional detail is needed, refer to Folding Top Cover Side Tension Cable Replacement in SI.



Note: The design of the top cover plastic retainer has changed slightly on the new corded top covers. The plastic retainer on the previous top covers had a slit near the end that allowed the side tension cable to pass through it as shown above.

Instead of a slit in the plastic, the retainer now has a large square hole at the very end, which is large enough to allow the cable anchor to pass through it. The retainer and square hole can be seen in the graphic below.



- 25.1. Starting on the left side, route the side tension cable through the backside of top cover edge plastic retainer as shown above.
 - 25.2. Next, route the cable through the small hole in the left side rail weatherstrip. It should run from the outside of the weatherstrip to the inside so that the cable is hidden, and it runs alongside the metal side rail itself.
- Note:** Ensure the cable anchor point is properly positioned. If additional information is needed, refer to #PIC5724.
- 25.3. Attach the cable anchor point back into the side rail and secure it with a piece of tape to hold it in place.
- Important:** The front springs and retaining screws will be attached to the #1 bow later in step #35.
- 25.4. Attach the forward side tension cable/spring end to a suitable wire, and starting at the bottom of the left top cover pocket, pull the tension cable and spring upward/forward through the cover material until the spring hangs from the exit slot at the front of the cover.
 - 25.5. Install the left top cover plastic retainer into the channel in the metal side rail.
- Note:** For more assistance, or if having difficulty, refer to #PIC5605.
- 25.6. Press the left rear side rail weatherstrip back in place and make sure it is secure.



Note: The graphic above shows the correct routing of the side tension cable once everything is reinstalled.

- 25.7. Repeat the same operation on the opposite side.
26. Reinstall the top assembly to the vehicle. Refer to Folding Top Frame Replacement in SI.



- 27. Position the folding top in the mid-open position. Clear any contents out of the rear seat and move the front seats forward. The technician v need to stand in the back seat to route and rivet the control cords and straps to the top frame.

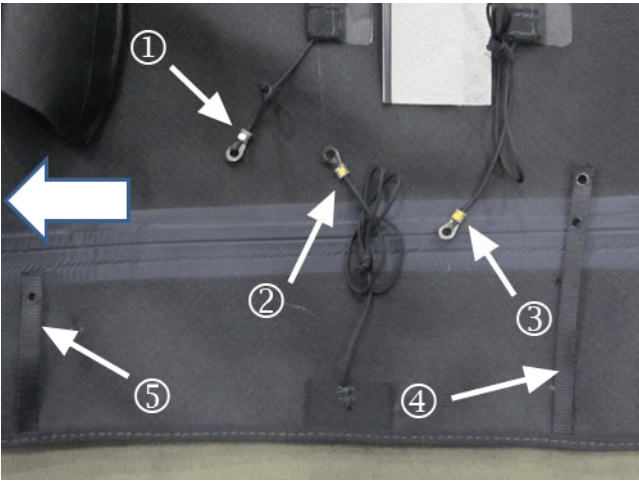

Note: The three cords added to each side of the top cover are color-keyed with paint dots on the cord eyelets. The orientation of the three colors white (1), yellow (2) and orange (3), along with the rear (4) and front (5) control straps, are shown above. The following steps will reference them as the white, yellow or orange control cords.

28. Rivet a new P-clip to the inboard hole of the #2 bow bracket on the left and right sides following the steps below:

Note: The **headliner** cord end eyelets will be riveted at a later step. They can hang off the top side of the P-clip for now.



- 28.1. Route the cord (no color dot) coming off the **headliner tab** upward through the bottom of the P-clip. Position the clip to the #2 bow so that the P-clip is facing outboard.

Note: The headliner control cord must be routed through the P-clip before installing the rivet.

- 28.2. Install the rivet. (The headliner cord end eyelets can hang off the top side of the P-clip for now. They will be riveted to the control line later in step #31.)

- 28.3. Repeat the same operation on the opposite side.

Note: For the eye loop installations, use the flatter design eye loop except as noted in step #30.

29. Rivet a new eye loop to the remaining inboard-most hole on the left and right sides of the #2 bow following the steps below:

- 29.1. Grab the 735 mm (29 in) yellow control cord, which is attached to a tab off the binding of the top cover.

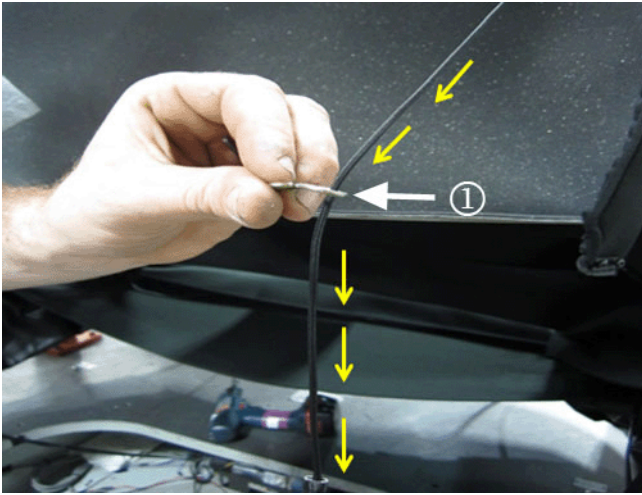

29.2. Route the cord downward through the large eye loop (1) with the eye loop angled downward as shown above.

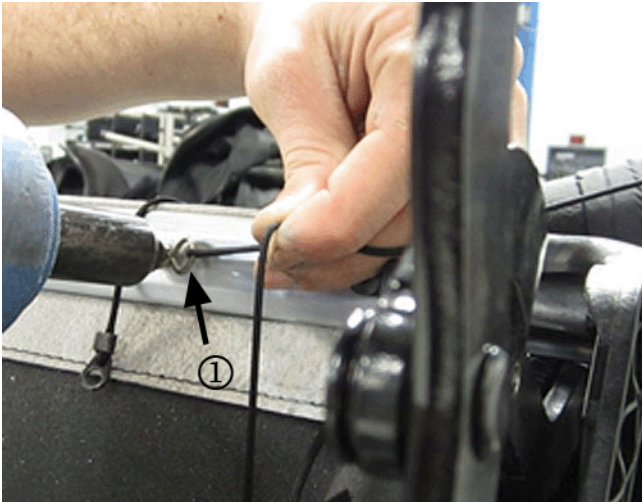

29.3. Install the rivet on the #2 bow through the small eye loop hole with the large eye loop hole (1) aimed outboard as shown above.

29.4. Repeat the same operation on the opposite side.

Note: The steps in the next several sections will normally need to be performed with the aid of an assistant.

Important: The eye loops attached to the left and right rear #1 bow links are the only two that contain a 75° bend. These unique bend eye loops are used in only these two locations.

30. Rivet a new 75° bend eye loop to the hole previously drilled in the left and right rear #1 bow link following the steps below:

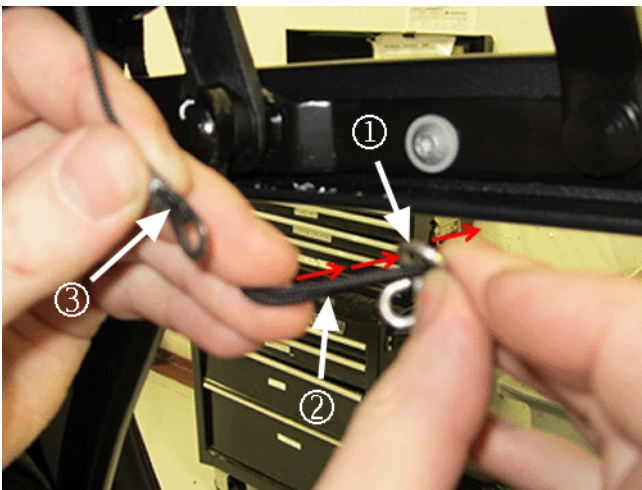

30.1. Holding the eye loop (1) with the 75° bend angled upward, route the yellow (2) and orange (3) top cover control cords down through the large eye loop opening.

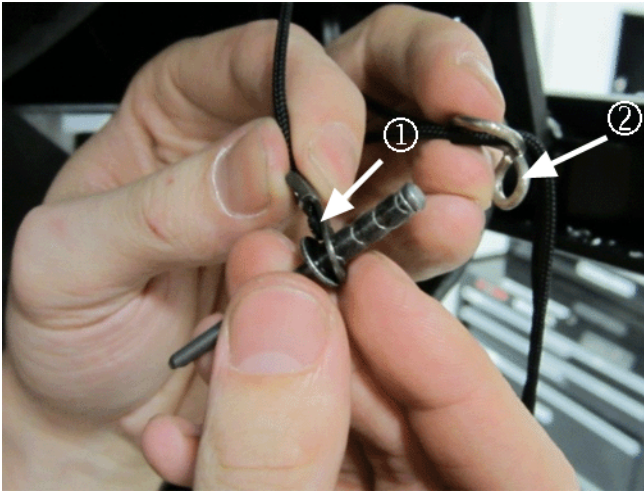

30.2. Grab the eyelet on the end of the white top cover control cord. Put the eyelet (1) on the new rivet, then add the eye loop (2) through small hole of the 75° bend eye loop.

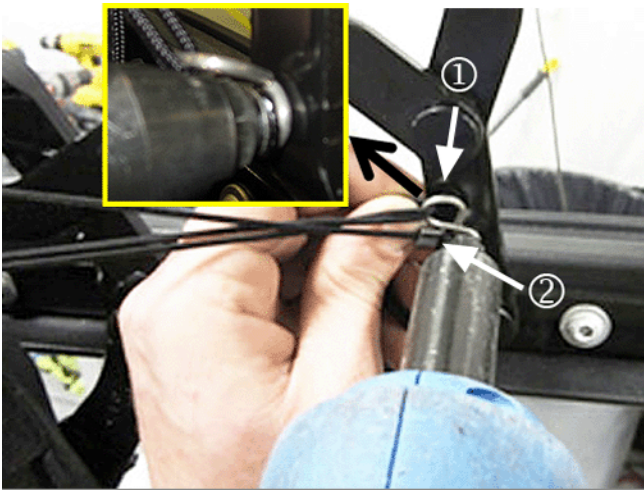

Note: The large eye loop should already have the yellow and orange control cords routed through it, prior to attaching the rivet.

30.3. Install the rivet to the rear #1 bow link with the 75° bend of the large eye loop angled inboard (as shown in the inset above) and the orientation of the eye loop (1) and the cord eyelet (2) as shown.

30.4. Repeat the same operation on the opposite side.

31. Rivet the end eyelets of the **headliner** cord (no color dot), along with a new P-clip, to the forward hole previously drilled in the left and right control links following the steps below:

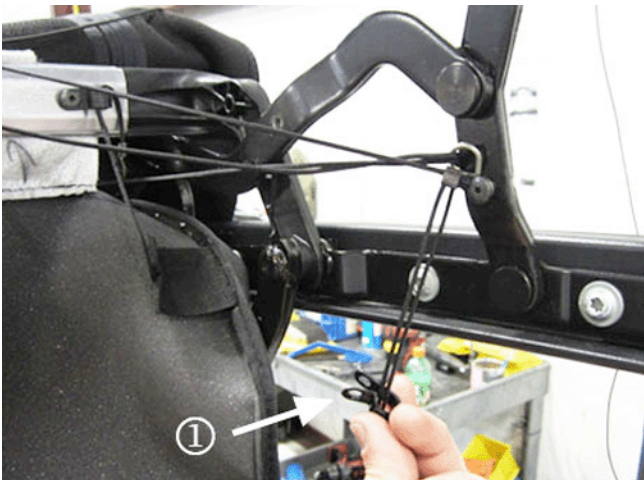

31.1. Grab a new P-clip (1) and route the yellow and orange control cords through the P-clip as shown above.



31.2. Insert a new rivet in the **headliner** eyelet, then through the P-clip (with the yellow and orange cords already running through it) and position them to the forward hole previously drilled in the control links.

31.3. Install the rivet to the control link with the orientation of the cord eyelet (1) and the P-clip (2) as shown above.

31.4. Repeat the same operation on the opposite side.

32. Rivet a new eyelet, along with the rear strap that is attached to the top cover binding, to the rearward hole previously drilled in the left and r control links following the steps below:

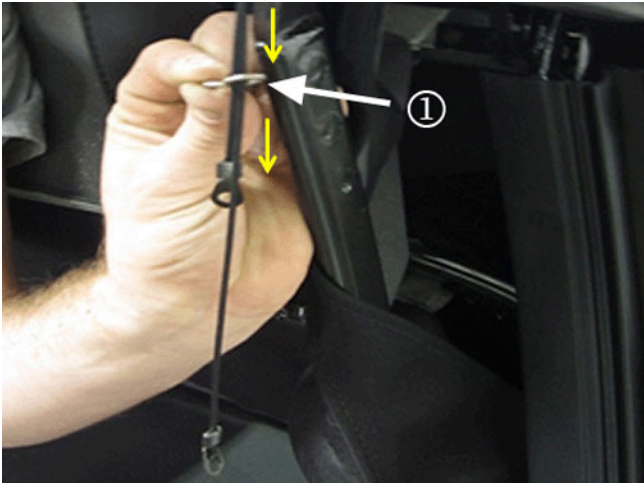

32.1. Route the yellow and orange control cords down through the large hole in a new eye loop (1) with the eye loop angled upward as shown above.

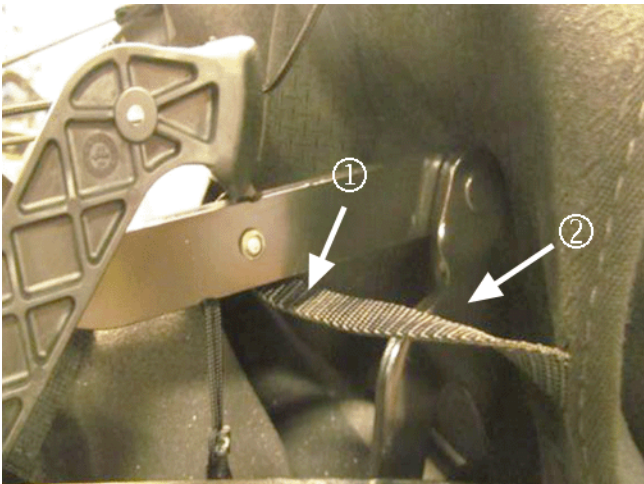

Important: Verify that the rear strap (1) of the top cover is routed under the side link and is not hung up behind, but is clear of, the wishbone link (2) as shown above.

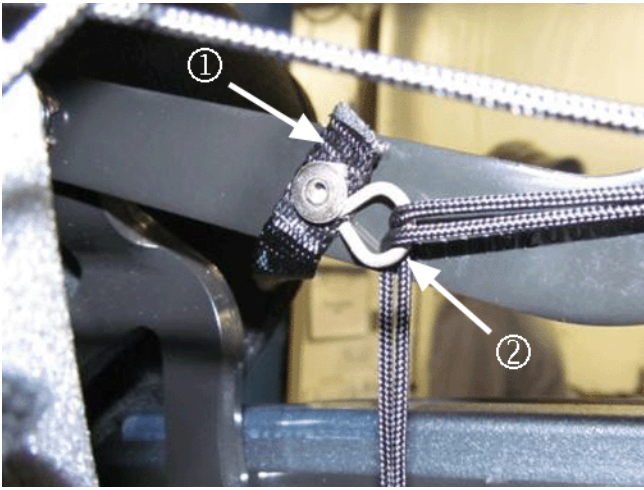

32.2. Insert a new rivet through the small opening in the eye loop (2), then through the strap (1) with the orientation of the eyelet and the strap as shown in the graphic above.

Note: The large eye loop should already have the yellow and orange control cords routed through it prior to attaching the rivet. Also ensure that the cover strap is oriented straight down and under the link and not angled forward or rearward.

32.3. Install the rivet to the control link.

32.4. Repeat the same operation on the opposite side.



33. Rivet both end eyelets of the yellow and orange control cords to the hole previously drilled in the left and right balance links following the steps below:

33.1. Insert a new 3.2 mm (0.125 in) rivet through the end eyelets on first the yellow (1), and then the orange (2), control cords.

33.2. Attach the rivet to the hole in the balance link as shown above.

33.3. Repeat the same operation on the opposite side.

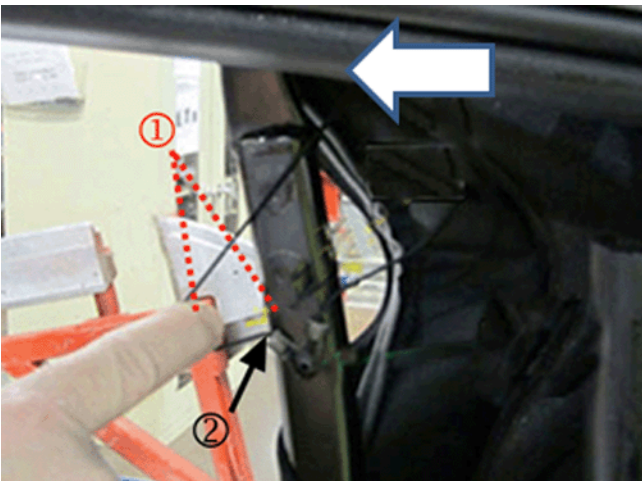

34. Balance the new cross-car control cord in the top cover's second pocket by completing the following steps:
- 34.1. Cycle the top to the half open position.
 - 34.2. Locate the second pocket control cord with the orange paint dot on the eyelet (2), which is the longer of the two cords riveted to the balance link.
 - 34.3. With your index finger, pull the cord forward, taking out the slack.
 - 34.4. When the cords are even from side to side, there will be a gap of about 25 mm (1.0 in) (1) between your finger and the balance link shown above. If the gap is less than an inch, reach into the top cover and gently pull the cord towards you, then recheck the gap. Noting the gap on one side, go to the other side of the top and repeat the process. Repeat this process from side to side until the gaps are equal.
35. Complete the installation of the headliner straps and corner supports, the tension cables and the top cover at the #1 bow. If additional detail needed, refer to Folding Top Cover Replacement in SI.

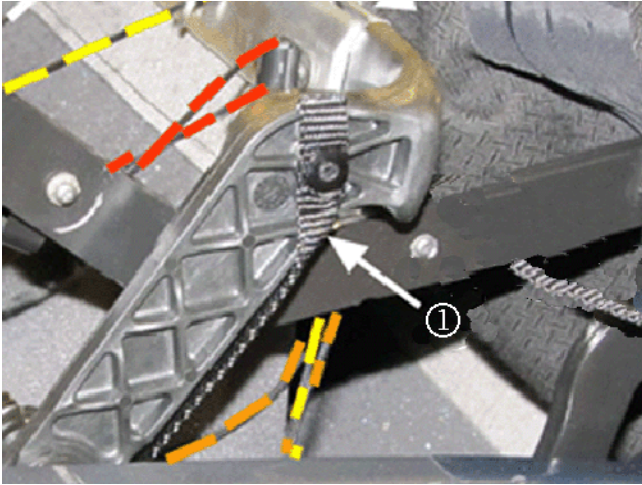

Important: Ensure the headliner strap is routed under, and towards the backside of, the #2 bow bracket.

- 35.1. Install the side headliner strap (1) to the left and right #2 bow brackets.



- 35.2. Install the tension cable spring and retaining screw (1) to both sides of the #1 bow.

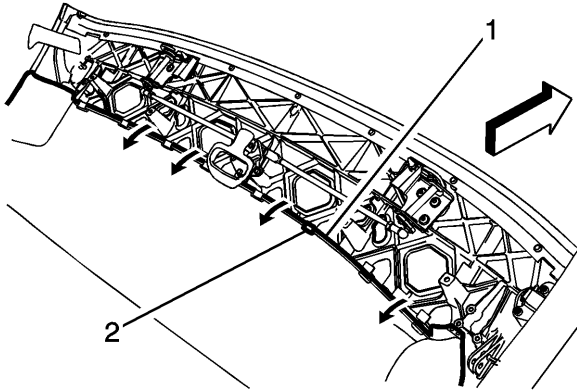

35.3. Install the headliner (1) to the #1 bow retainers (2) across the inner lower edge of the bow.

35.4. Install the #1 bow garnish molding.

35.5. Install the side front top cover strap to the rear of the #1 bow link, and install the top cover over the #1 bow.

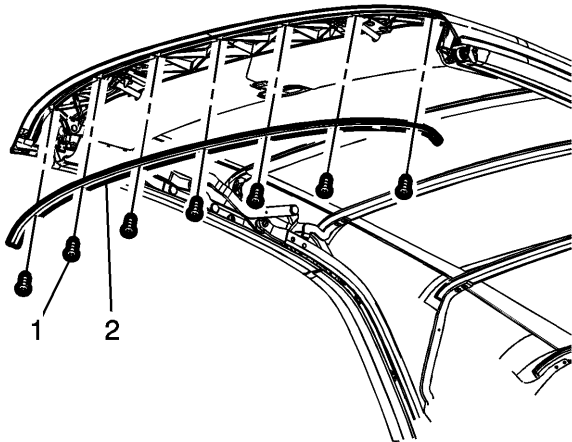

35.6. Install the top cover front edge retainer and screws.

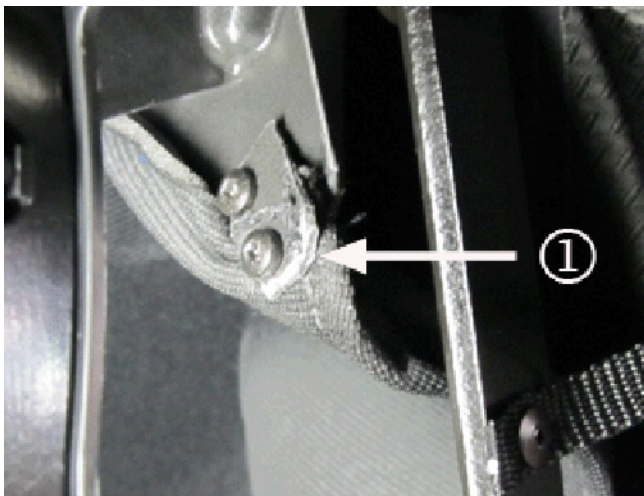

35.7. Position the headliner front corner supports to the left and right flipper doors, and install the retaining screws.

- 36. After balancing the cross car cord and completing the top cover installation, cycle the top to the fully stowed position before cycling the top closed.
- 37. Verify proper operation of the folding top.
- 38. Water test the folding top to verify there are no water leaks.

Warranty Information

For vehicles repaired under warranty, use:

Labor Operation	Description	Labor Time
B6823*	Retrofit Replacement of New Corded Top Cover to Original Design Frame	7.0 hrs
Add	For vehicles equipped with 6 tube drain panel system	0.4 hr

*This is a unique labor operation for bulletin use only. It will not be published in the Labor Time Guide.

GM bulletins are intended for use by professional technicians, NOT a "do-it-yourselfer". They are written to inform these technicians of conditions that may occur on some vehicles, or to provide information that could assist in the proper service of a vehicle. Properly trained technicians have the equipment, tools, safety instructions, and know-how to do a job properly and safely. If a condition is described, DO NOT assume that the bulletin applies to your vehicle, or that your vehicle will have that condition. See your GM dealer for information on whether your vehicle may benefit from this information.



WE SUPPORT VOLUNTARY TECHNICIAN CERTIFICATION