

Technical Service Bulletin



57 Outer door seals loose

57 12 74 2027494/4 October 3, 2012. Supersedes Technical Service Bulletin Group 57 number 12 – 71 dated September 17, 2012 for reasons listed below.

Model(s)	Year	VIN Range	Vehicle-Specific Equipment
A4	2011	FL BA109486 – FL BA999999	Not Applicable
	2011	FL BN040729 – FL BN999999	
	2012	000001 – 999999	
	2013	000001 – 999999	
Audi Q5	2011	000001 – 999999	
	2012	000001 – 999999	
	2013	000001 – 999999	

Condition

REVISION HISTORY		
Revision	Date	Purpose
4	-	Revised <i>Warranty</i> (SRTs)
3	9/17/2012	Revised header data (Added model year 2013)
2	10/31/2011	Revised <i>Service</i> Revised <i>Required Parts and Tool</i> (Added parts)
1	9/7/2011	Original publication

The outer door seals have become partially detached



Figure 1. The outer door seal, partially detached.

Technical Background

Loss of adhesion between the door structure and door seal due to a flaw in the attachment process in production.

Production Solution

No changes to production have been made, as no issue has been identified.

Service



Note:

Audi of America is requesting your cooperation in supplying us with technical information regarding this condition. Before repairing the door seals using the procedure in TSB 2019733, please complete the door seal survey at:

<http://www.surveymonkey.com/s/B8DoorSealSurvey>

Answer the questions regarding the extent and location of detachment of the door seals from the tables shown below:



Technical Service Bulletin

Audi

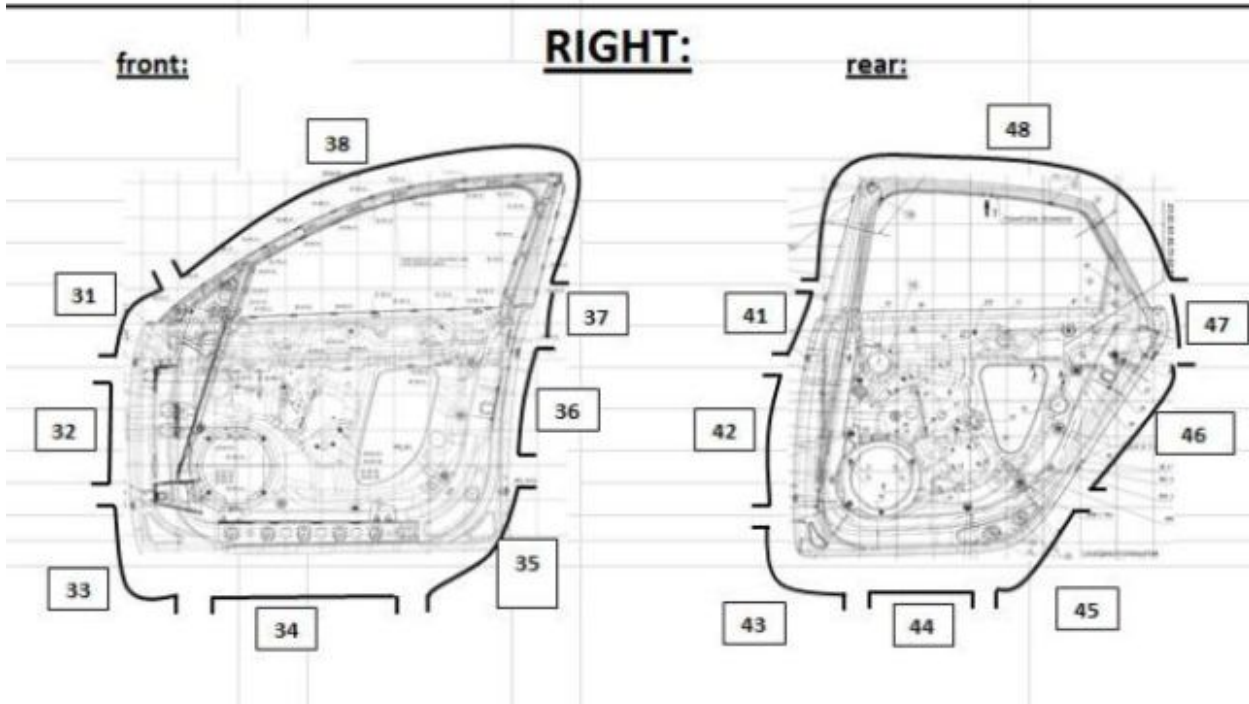
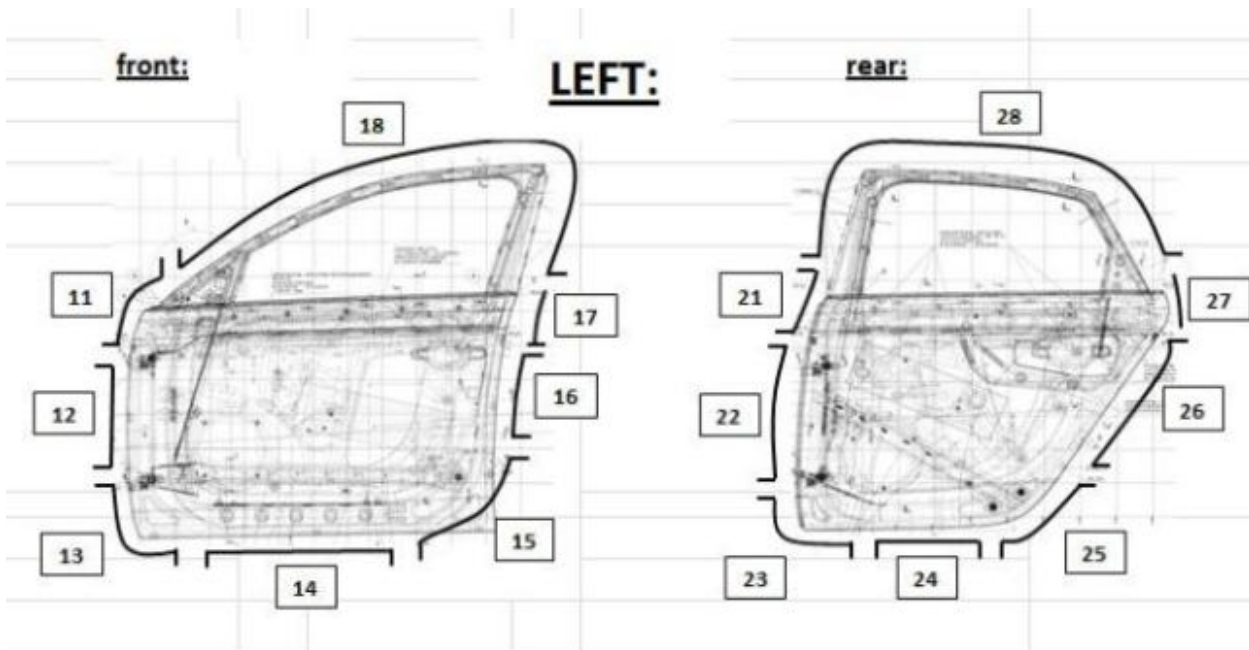



Audi

Technical Service Bulletin





 <p>Type 1:</p> <ul style="list-style-type: none">▪ 1.0 – 2.0 mm loose <p>▪ No repair is necessary</p>	 <p>Type 2:</p> <ul style="list-style-type: none">▪ Detachment width: 2.0 mm – 5.0 mm▪ Detachment length: 0 mm – 50 mm <p>▪ Repair is necessary</p>
 <p>Type 3:</p> <ul style="list-style-type: none">▪ Detachment width: 5.0 mm – 8.0 mm▪ Detachment length: 50 mm – 200 mm <p>▪ Repair is necessary</p>	 <p>Type 4:</p> <ul style="list-style-type: none">▪ Detachment width: Completely loose▪ Detachment length: Greater than 200 mm <p>▪ Door seal must be replaced</p>

Figure 2. Door seal locations and types.

Answering these questions in the survey will help us gather information to implement further production improvements. After the survey is completed, continue with any necessary repairs. The procedure for repair follows.

In cases where the outer door seal has become partially detached, it may not be necessary to replace the outer door seal. Seals can be reattached provided they are not damaged, have not been previously repaired or previously reattached, and the detachment length does *not* exceed 10 cm.

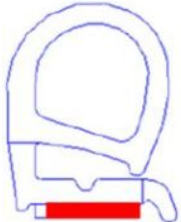
1. Inspect all four doors.

- All undamaged, previously unrepaired or loose seals with a detachment length less than 10 cm will be repaired. Complete steps 2-10 below to repair the door seals.
- If the door seal is damaged, has been previously repaired or previously reattached or detached greater than 10 cm, replace the door seal according to the repair instructions in *ElsaWeb* >> *Body* >> *Body Exterior* >> *57 Front Doors, Central Locking System* >> *Removal and Installation* >> *Doors* >> *Door Seals*. In the case of a rear door seal replacement, refer to *ElsaWeb* >> *Body* >> *Body Exterior* >> *58 Rear Doors* >> *Removal and Installation* >> *Rear Door* >> *Door Seals*.



Note:

In addition to the repair manual instructions for replacing the door seals observe the following: Thoroughly clean the area of seal attachment with plastic cleaner **D 00940104**. Allow the area of seal attachment to dry completely (at least 5 minutes). Apply bonding agent **D 355205A2** using a **D 00950025** applicator to the seal attachment area. Allow to dry an additional 5 minutes.

If repairing the door seals, proceed as follows:

2. Ensure that the temperature of the door and outer door seal are not cooler than 70°F (21°C). This is vital to ensure optimum adhesion of the outer door seal.

3. Thoroughly clean the bonding surfaces of the doors to be repaired with plastic cleaner **D 00940104**. Allow the bonding surfaces to dry completely (at least 5 minutes). The bonding surfaces must be dry and free of any dust, grease, silicone or any other similar contaminant that might compromise the adhesion.
4. Apply bonding agent **D 355205A2** using a **D 00950025** applicator in the area to be bonded. Allow the treated surface to dry an additional 5 minutes.
5. Thinly coat the outer door seal with rubber profile adhesive **D 477KD1A2** in the area that has become detached.

6. Press the door seal lightly to the door surface and then detach it again (Figure 3). This ensures that the glue is distributed as evenly as possible on the surfaces to be bonded.

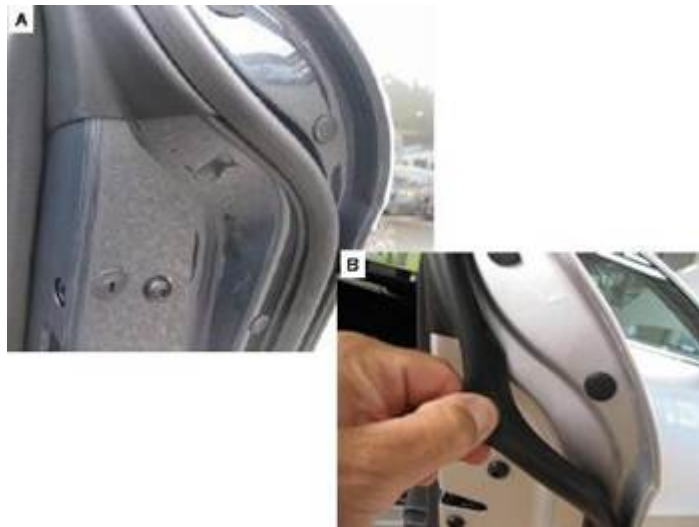

Figure 3. The door seal pressed to the door (A), and detached again (B).

7. Allow the now detached area to dry for 5 minutes.

8. After this time attach the seal firmly to the door surface. Roll over this area several times with special tool **3356** (or equivalent).

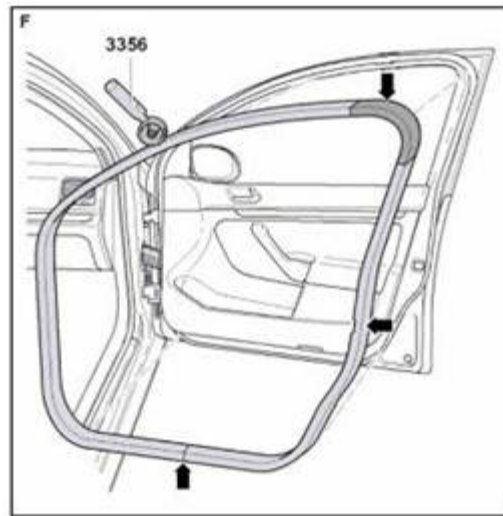

Figure 4. Use of special tool 3356.

9. Apply force to the seal with the **3356** only at the base of the seal (Figure 5, 3).



Figure 5. Apply force to seal.

10. Remove any residual adhesive that may be visible with adhesive remover **D 002000A2**.



Tip: The repaired door should *not* be closed for two hours. During this time, any freshly glued surfaces should *not* be tested by pulling on the seal to see if they have bonded.

Technical Service Bulletin



Warranty

Claim Type:	Use applicable claim type. If vehicle is outside any warranty, this Technical Service Bulletin is informational only.		
Service Number:	5765		
Damage Code:	0018		
Labor Operations:	Check all door seals and report condition via survey.	57 65 99 99	20 TU
	Front Door - A4:		
	Front door trim panel remove and reinstall	70 59 19 00	40 TU
	Additional seal remove and reinstall	57 65 19 50	40 TU
	Clean residual adhesive	57 65 99 99	10 TU
	Front Door – Audi Q5:		
	Outer front door seal remove and reinstall	57 65 19 00	40 TU
	Clean residual adhesive	57 65 99 99	10 TU
	Rear Door – Both A4 and Audi Q5:		
	Rear door trim panel remove and reinstall	70 73 19 00	30 TU
	Rear door outer seal remove and reinstall	58 64 19 50	40 TU
	Clean residual adhesive	58 64 99 99	10 TU
	Diagnostic Time:	GFF	No allowance
Road test prior to service procedure		No allowance	0 TU
Road test after service procedure		No allowance	0 TU
Technical diagnosis at dealer's discretion (Refer to Section 2.2.1.2 and Audi Warranty Online for DADP allowance details)			
Claim Comment:	As per TSB #2027494/4		

All warranty claims submitted for payment must be in accordance with the *Audi Warranty Policies and Procedures Manual*. Claims are subject to review or audit by Audi Warranty.

Required Parts and Tools

Part Number	Part Description	Quantity Required per Door
D 00940104	Plastic cleaner	0.25
D 355205A2	Bonding agent	0.25
D 477KD1A2	Rubber profile adhesive	0.25
D 002000A2	Adhesive remover	0.1
Part Number	Part Description	Quantity Required per Vehicle
D 00950025	Applicator	1

Tool Number	Tool Description	Note
3356	Roller	Equivalent, suitable tool may be used.

Additional Information

All parts and service references provided in this TSB are subject to change and/or removal. Always check with your Parts Department and service manuals for the latest information.