

SERVICE PROCEDURE

25507R1

October, 2025

SUBJECT: SAFETY RECALL

Brake systems on certain 2019 thru 2025 International® CV™ Series trucks built 1/11/2018 thru 9/9/2024, manufactured without a silicone block harness, with feature codes 0004198, 0004240 (Brake system, hydraulic with Hydromax brake booster).

CUSTOMER LETTER

Print ready (PDF file) copy of the Customer Letter.

REVISION STATEMENT

Update to procedure to include taping of harness.

DEFECT DESCRIPTION

These vehicles may have been built with a brake pressure switch assembly that allows brake fluid to leak beyond the diaphragm seal into the pressure switch. The brake fluid may seep into the electrical components and short the brake pressure switch.

If brake fluid shorts the brake pressure switch and the associated fuse, the circuit can generate excessive heat that can result in a fire increasing the risk of property damage or personal injury to the operator.

MODELS INVOLVED

This safety recall involves certain International® CV™ Series trucks remedied under Safety Recall 23V-282 (International 23511) and manufactured without a silicone block harness, built 1/11/2018 thru 9/9/2024 with feature codes 0004198, 0004240 (Brake system, hydraulic with Hydromax brake booster).

ELIGIBILITY

This procedure applies ONLY to vehicles marked in the International® Service PortalSM with Safety Recall 25507. Also complete any other open campaigns listed on the Service Portal at this time.

PARTS INFORMATION

NOTE: Depending on the location of the brake pressure switch on the vehicle you are working on, there are two brake pressure switch jumper harnesses. Harness Part Number 8900388R91 is for vehicles built 11/30/2020 and prior. Harness Part Number 8900387R91 is for vehicles built 12/01/2020 and after.

Part Number	Part Description	Quantity
8900388R91	Harness, Brake Jumper; Built 11/30/2020 And Prior	1
8900387R91	Harness, Brake Jumper; Built 12/01/2020 And After	1
306132C1	Strap, Cable, 14-inch	As Needed
476074C1	Nut, Battery Terminal 3/8" UNC	1
NANO2133005	Dielectric Grease Coating (BLUE)	As Needed
7096462C1 or Purchase locally	Tape, Electrical Harness (25' Roll) Coloplast 837X	As Needed

Table 1 Parts Information

SERVICE PROCEDURE

WARNING! To prevent personal injury and / or death, or damage to property, park vehicle on hard flat surface, turn the engine off, set the parking brake and install wheel chocks to prevent the vehicle from moving in either direction.

WARNING! To prevent personal injury and / or death, or damage to property, if the vehicle must be raised, do not work under the vehicle supported only by jacks. Jacks can slip or fall over.

WARNING! To prevent personal injury and / or death, always wear safe eye protection when performing vehicle maintenance.

WARNING! To prevent personal injury and / or death, or damage to property, allow engine / vehicle components to cool before servicing engine or vehicle.

WARNING! To prevent personal injury and / or death, or damage to property, keep flames or sparks away from vehicle and do not smoke while servicing the vehicle's batteries. Batteries expel explosive gases.

WARNING! To prevent personal injury and / or death, or damage to property, remove the ground cable from the negative terminal of the battery box before disconnecting any electrical components. Always connect the ground cable last.

1. Park vehicle on flat surface.
2. Shift transmission to Park or Neutral and set parking brake.
3. Turn vehicle ignition to Key OFF position.
4. Install wheel chocks.
5. Disconnect and isolate negative battery cable on main vehicle battery.
Discard battery terminal nut.
6. Unlatch and open hood.

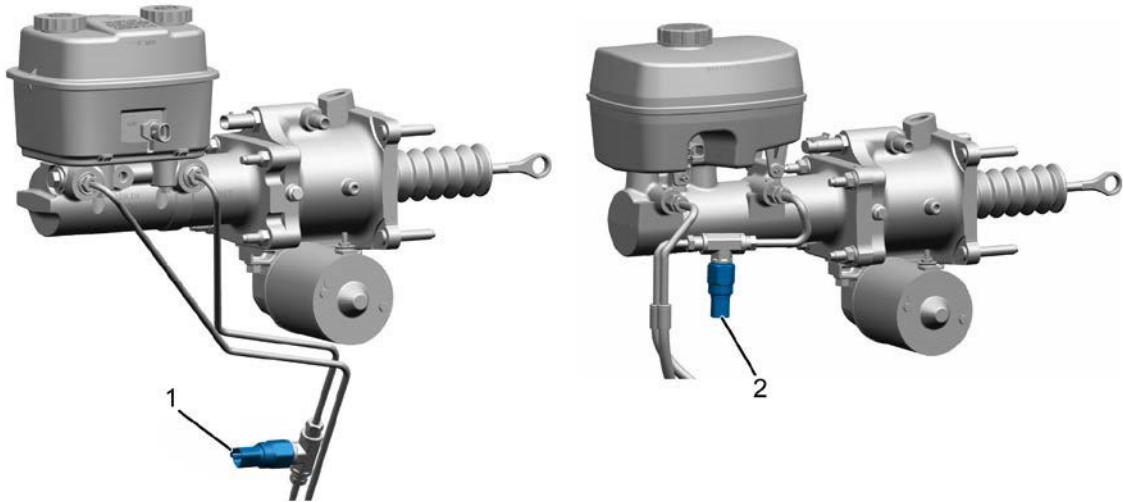

0000478040

Figure 1. Brake Pressure Switch Placement

1. Built 11/30/2020 and prior
2. Built 12/01/2020 and after

NOTE: Placement of the brake pressure switch is different for vehicles built 11/30/2020 and prior and vehicles built 12/01/2020 and after (Figure 1, Items 1 and 2).

NOTE: Harness part number 8900388R91 will require the harness to have electrical harness tape installed, if it is not already fully taped. The tape is to prevent abrasion to the harness from other components.



0000491901

Figure 2. Harness Not Fully Taped

1. Harness

7. Verify that the replacement harness is fully taped.
 - a. If the harness is not fully taped (Figure 2), proceed to Step 8.
 - b. If the harness is fully taped, proceed to Step 11.

8. When wrapping the harness start with three wraps around the harness and finish up with three wraps. The electrical tape should overlap the previous wrap and be half the width of the tape.

9. When taping the junction areas of the harness, the electrical tape should be wrapped around all wires going to the junction area and should overlap half the width of the previously installed wrap.

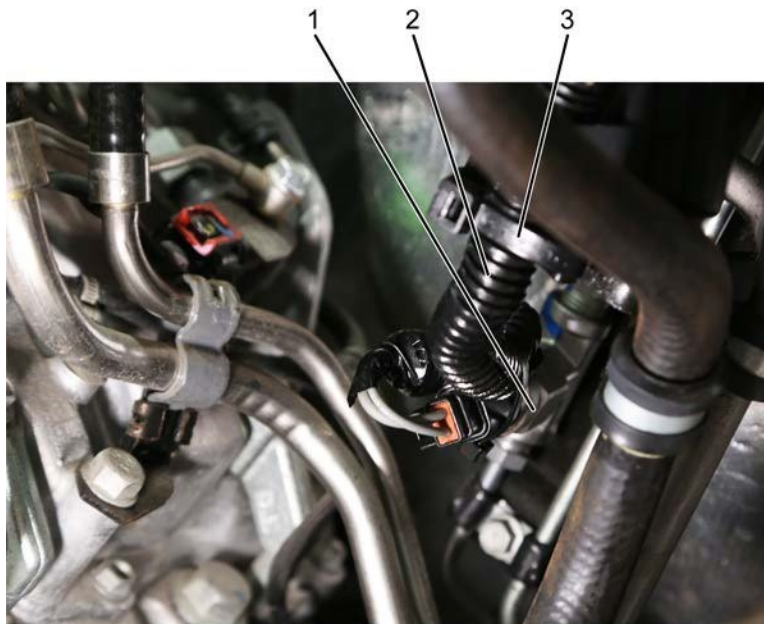

0000478041

Figure 3. Brake Pressure Switch Connector Location

1. Brake pressure switch connector
 2. Harness connector
 3. Cable tie strap
-
10. Locate the brake pressure switch connector (Figure 3, Item 1) located near vehicle master cylinder.
 11. Disconnect harness connector (Figure 3, Item 2) from the brake pressure switch connector (Figure 3, Item 1).

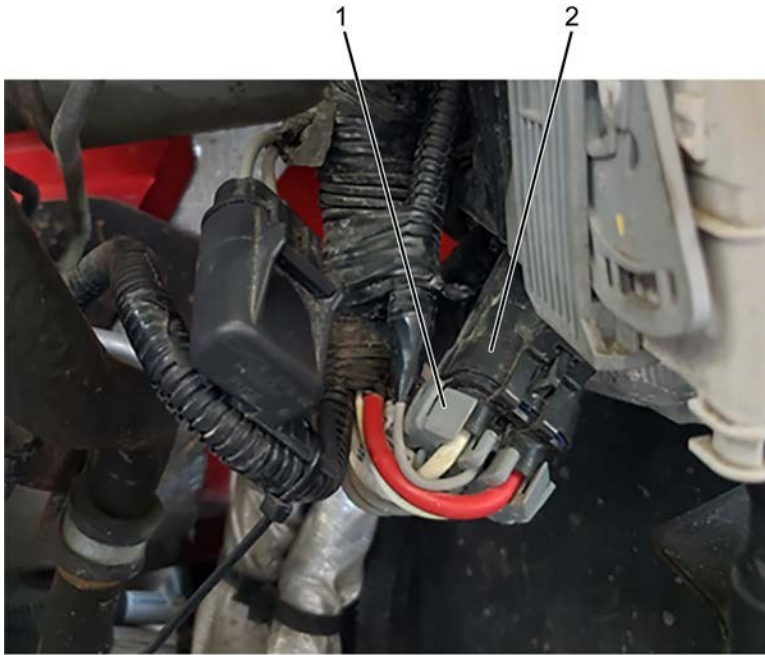

0000478044

Figure 4. Booster Pump Motor Jumper Harness Connector

1. Booster pump motor jumper harness connector
2. Center chassis harness connector

12. Disconnect the booster pump motor jumper harness connector (Figure 4, Item 1) from the center chassis harness connector (Figure 4, Item 2).

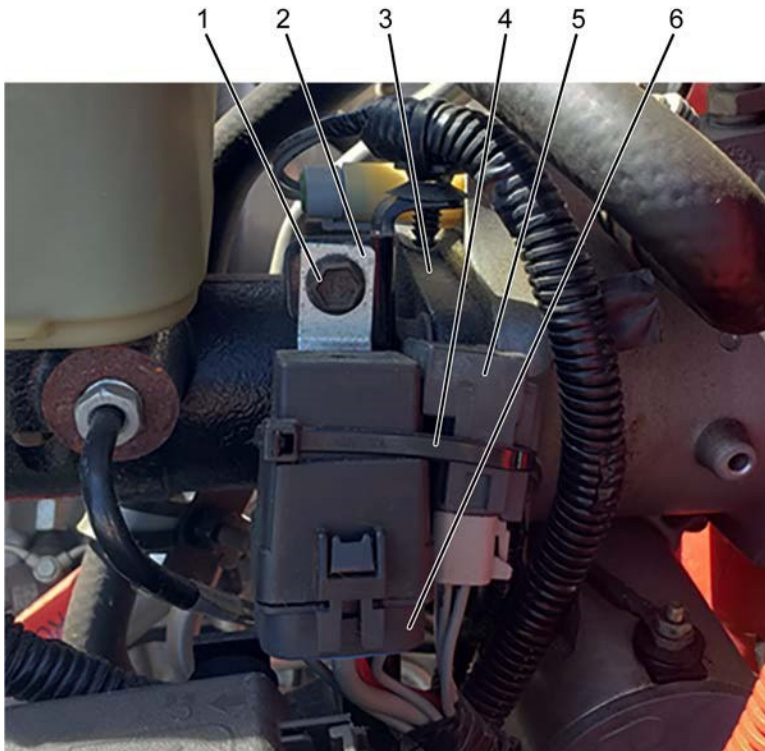

0000478045

Figure 5. Relay Mount

1. Bolt
2. Relay mounting bracket
3. Master cylinder
4. Cable tie strap
5. Diode
6. Relay connector

13. Cut and discard cable tie strap (Figure 5, Item 4) connecting diode (Figure 5, Item 5) to relay mounting bracket (Figure 5, Item 2). Disconnect relay connector (Figure 5, Item 6).

14. Verify the vehicle build date.

- a. For vehicle built 11/30/2020 and prior, disconnect master cylinder fluid level sensor mounted on brake fluid reservoir, low-pressure brake switch connector mounted on master cylinder, and brake booster flow switch mounted on the Hydromax booster.
- b. For vehicle built 12/01/2020 and after, disconnect master cylinder fluid level sensor mounted on brake fluid reservoir and brake booster flow switch mounted on the Hydromax booster.

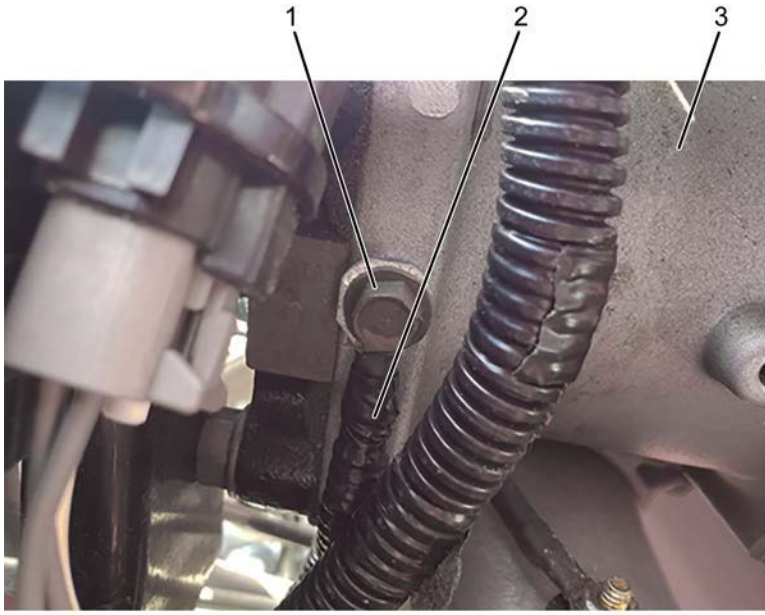

0000478046

Figure 6. Hydromax Brake Booster

1. Bolt
2. Ground wire
3. Hydromax brake booster

15. Remove bolt (Figure 6, Item 1) securing ground wire (Figure 6, Item 2) to the Hydromax brake booster (Figure 6, Item 3). Reposition ground wire and save bolt for reuse.

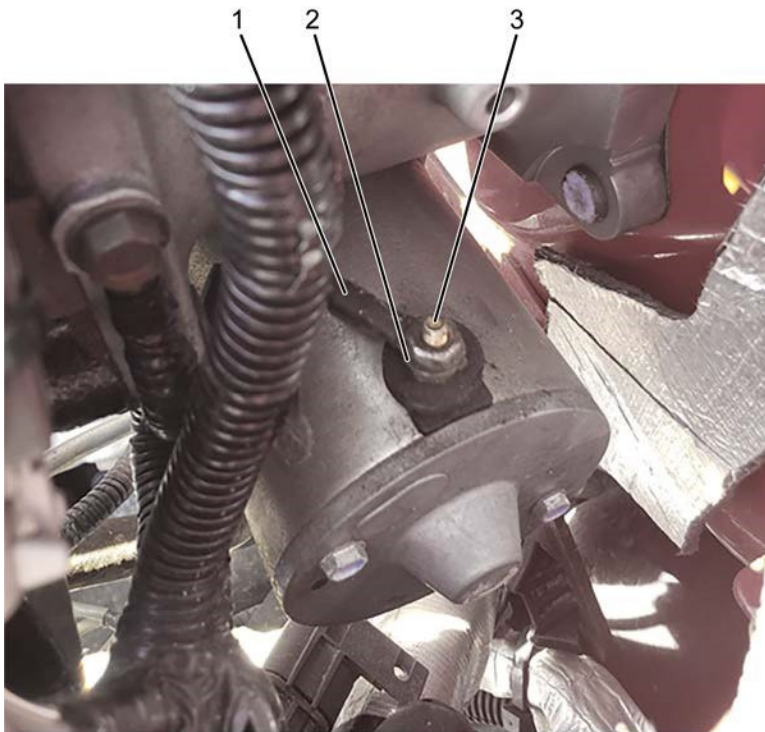

0000478047

Figure 7. Booster Pump

1. Power wire
2. Nut and lock washer
3. Booster pump motor terminal

16. Remove nut and lock washer (Figure 7, Item 2) securing power wire (Figure 7, Item 1) to booster pump motor terminal (Figure 7, Item 3). Reposition power wire and save nut and lock washer for reuse.

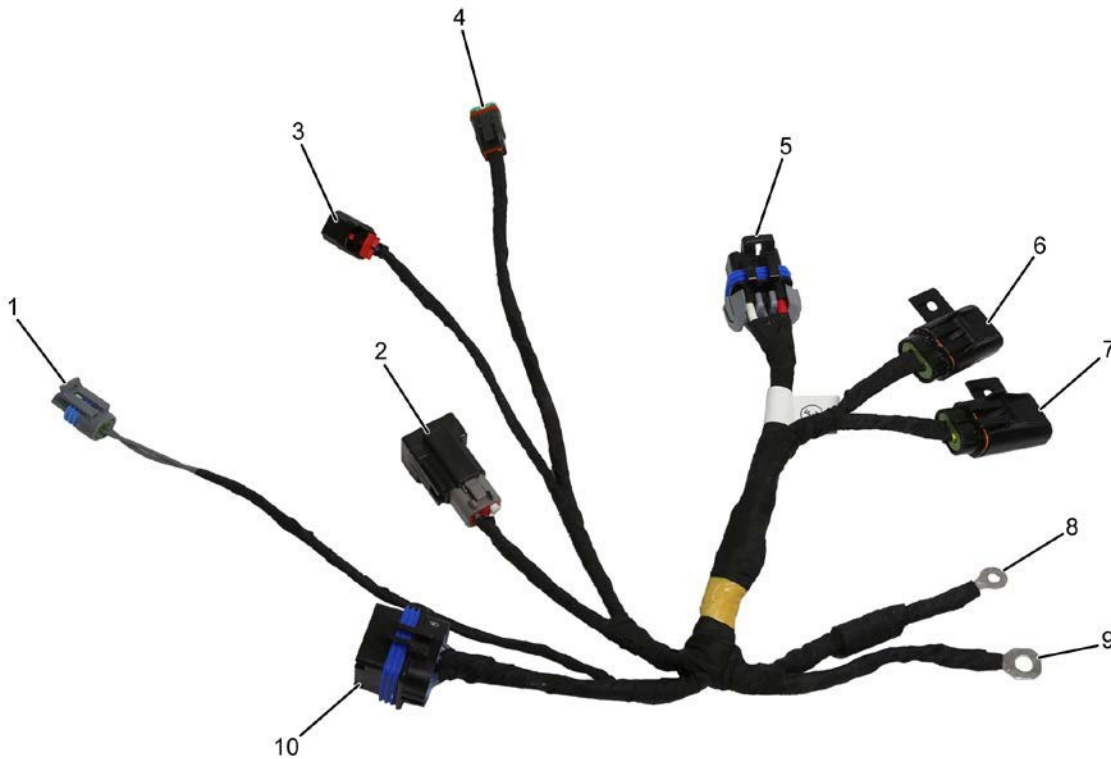

0000478048

Figure 8. Brake Jumper Harness for 12/01/2020 and later

1. Brake booster flow switch connector
2. Diode
3. Brake fluid level sensor connector
4. Brake pressure switch connector
5. Booster pump motor jumper harness connector
6. 5-amp fuse
7. 5-amp fuse
8. Power terminal
9. Ground terminal
10. Relay connector

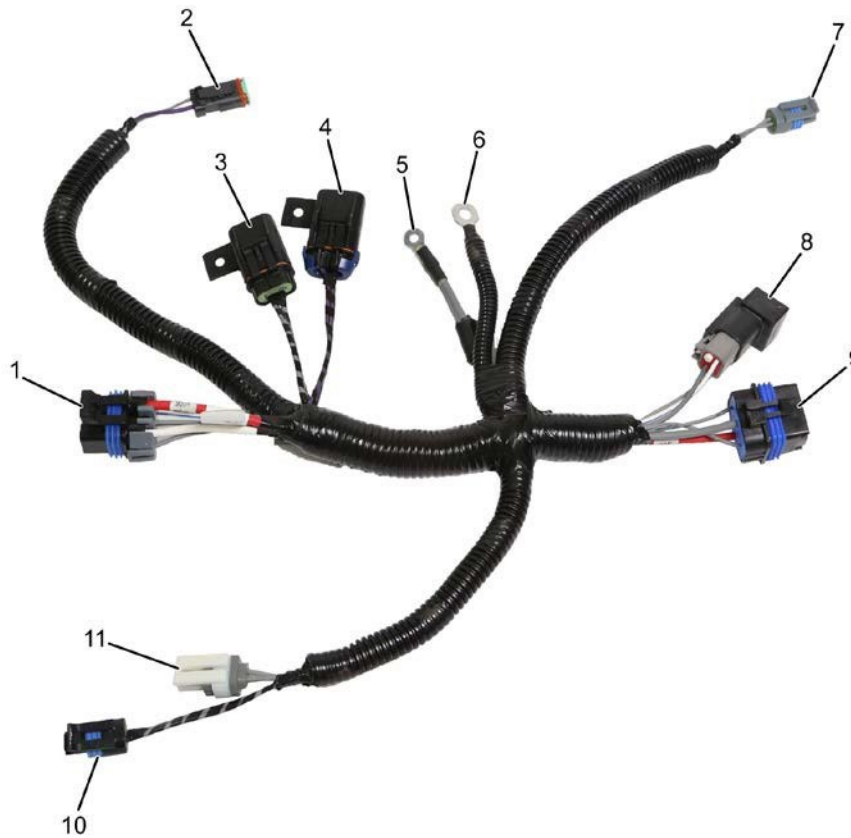

0000478049

Figure 9. Brake Jumper Harness for 11/30/2020 and prior

1. Booster pump motor jumper harness connector
2. Brake pressure switch connector
3. 5-amp fuse
4. 5-amp fuse
5. Power terminal
6. Ground terminal
7. Brake booster flow switch connector
8. Diode
9. Relay connector
10. Master fluid level sensor
11. Low pressure flow switch connector

17. Record harness routing and location of cable wire ties and clipping saddles.

18. Cut and discard cable ties securing harness and remove harness from vehicle. Discard harness.

CAUTION! To prevent damage to property, use caution while routing harness. Failure to do so can lead to damage to harness.

19. Using previously recorded routing and clipping locations, route new harness as noted in Step 14.
20. Position ring terminal of power wire (Figure 7, Item 1) over booster pump motor terminal (Figure 7, Item 3). Install lock washer and nut removed in Step 13 (Figure 7, Item 2).
21. Using torque wrench, tighten booster pump motor terminal nut to 17 lb-in (2 N·m).

CAUTION! To prevent damage to property, ensure even application of dielectric grease to backup pump power terminal nut and booster pump ground bolt. Failure to do so can result in damage to property.

22. Evenly apply dielectric grease to top of backup pump power terminal nut.
23. Evenly apply dielectric grease to both sides of ground ring terminal eyelet.
24. Position ground bolt (Figure 6, Item 1) through ring terminal eyelet of the ground wire (Figure 6, Item 2) and into the Hydromax brake booster.
25. Using torque wrench, tighten ground bolt to 102 lb-in (11.5 N·m).
26. Verify the vehicle built date.
 - a. For vehicle built 11/30/2020 and prior, connect master cylinder fluid level sensor mounted on brake fluid reservoir, low-pressure brake switch connector mounted on master cylinder, and brake booster flow switch mounted on the Hydromax booster.
 - b. For vehicle built 12/01/2020 and after, connect master cylinder fluid level sensor mounted on brake fluid reservoir and brake booster flow switch mounted on the Hydromax booster.
27. Connect relay connector (Figure 5, Item 6).
28. Connect booster pump motor jumper harness connector to center chassis harness connector.
29. Route brake hydraulic pressure switch connector to the brake hydraulic switch.
30. Using cable tie strap, secure both fuse holders to brake jumper harness.

31. Using a cable tie strap, secure diode (Figure 5, Item 5) to relay mounting bracket (Figure 5, Item 2).
32. Connect brake hydraulic switch connector to the brake hydraulic switch.
33. Using a cable tie strap (Figure 3, Item 3), secure brake hydraulic switch harness connector (Figure 3, Item 2) to its clipping point.
34. Using a wire brush, electronic contact cleaner, and compressed shop air, clean negative battery terminal components.
35. Apply BLUE dielectric grease to battery terminal stud, negative battery cable ring terminal, and threads of new battery stud nut.
36. Using new battery stud nut, reconnect negative battery cable to negative terminal on main vehicle battery and install new battery terminal nut.
37. Using torque wrench, tighten battery stud nut to 12–15 lb-ft (16–20 N·m).
38. Turn ignition switch to Key ON, engine OFF position.
39. Depress brake pedal to verify backup booster pump motor operation.
40. Turn ignition to Key OFF position.
41. Close and latch hood.
42. Remove wheel chocks.

END OF SERVICE PROCEDURE

LABOR INFORMATION

Operation Number	Description	Time
A40-25507-1	Replace Brake Switch Harness	0.6 hrs
A40-25507-2	Tape Harness For CV Built Before 12/1/2020	0.2 hrs

Table 2 Labor Information

CAMPAIGN IDENTIFICATION LABEL

Each vehicle corrected in accordance with this campaign must be marked with a CTS-1075 Campaign Identification Label.

Complete the label and attach on a clean surface next to the vehicle identification number (VIN) plate.

DO NOT REMOVE
INTERNATIONAL
Campaign No.
VIN
Eng.#
COMPLETED
Service Location Code #
DO NOT REMOVE

ADMINISTRATIVE / DEALER RESPONSIBILITIES

WARRANTY CLAIMS

Warranty claim expense is to be charged to Warranty. Claims are to be submitted in the normal manner, making reference to Safety Recall 25507.

Section 7 of the Warranty Policy and Procedures Manual contains further information related to the submission and processing of AFC / Recall claims.

As with all claim submissions, items acquired locally must be submitted in the "Other Charges" tab. The cost of any bulk items (such as a bag of cable tie straps, roll of wire, barrel of oil, or tube of silicone) should be prorated for the cost of the individual pieces / amount used during each repair.

	GROUP	NOUN	C	WARR.	TP	PAD
GROUP — Enter number						
NOUN — Leave blank						
C (CAUSE) — Enter either 1, 2, 3. (See below)						
1. Inspected (No repair required).						
2. Inspected and repaired.						
3. Defective part from parts stock.						
WARRANTY — (Warranty Code) Enter 40.						
TYPE PART — Enter P for type part causing failure.						
PAD — Enter 100						

0000047910

UNITED STATES AND POSSESSIONS

The National Traffic and Motor Vehicle Safety Act, as amended, provides that each vehicle that is subject to a vehicle recall campaign must be adequately repaired within a reasonable time after the owner has tendered it for repair. A failure to adequately repair within 60 days after a tender of a vehicle is prima facie evidence of failure to repair within a reasonable time. If the condition is not adequately repaired within 60 days, the owner may be entitled to replacement with an identical or reasonable equivalent vehicle at no charge, or to a refund of the purchase price less reasonable allowance for depreciation.

Dealers must correct all vehicles subject to this campaign at no charge to the owner, regardless of mileage, age of vehicle, or ownership, from this time forward.

Dealers should proceed immediately to make necessary correction to units in inventory. Federal law prohibits a dealer from delivering under a sale or lease, a new motor vehicle or any new or used item of motor vehicle equipment (including a tire) covered by the notification of a recall until the defect or noncompliance is remedied.

Dealers must make every effort to promptly schedule an appointment with each owner to repair his or her vehicle as soon as possible. However, consistent with the customer notification, dealers are expected to complete the repairs on the mutually agreed upon service date.

Dealers involved in the recall process will be furnished a listing of owner names and addresses to enable them to follow up with owners and have the vehicles corrected. Use of this listing must be limited to this campaign because the list may contain information obtained from state motor vehicle registration records, and the use of such motor vehicle registration data for purposes other than this campaign is a violation of law in several states.

CANADA

Dealers must correct all vehicles subject to this campaign at no charge to the owner, regardless of mileage, age of vehicle, or ownership, from this time forward.

Dealers should proceed immediately to make necessary correction to units in inventory. All inventory vehicles subject to this recall campaign must be corrected prior to sale, transfer or delivery. If vehicles have been sold or transferred and you are in receipt of Customer Notification Letters and Authorization for Recall Service cards for those vehicles, the transfer location or customer must be notified immediately from your dealer location.

Dealers must make every effort to promptly schedule an appointment with each owner to repair his or her vehicle as soon as possible. However, consistent with the customer notification, dealers are expected to complete the repairs on the mutually agreed upon service date.

Dealers involved in the recall process will be furnished a listing of owner names and addresses to enable them to follow up with owners and have the vehicles corrected. Use of this listing must be limited to this campaign because the list may contain information obtained from state motor vehicle registration records, and the use of such motor vehicle registration data for purposes other than this campaign is a violation of law in several states.

EXPORT

Export Distributors should proceed immediately to make necessary correction to units in inventory. All inventory vehicles subject to this recall campaign must be corrected prior to sale, transfer or delivery. If vehicles have been sold or transferred and you are in receipt of Customer Notification Letters and Authorization for Recall Service cards for those vehicles, the transfer location or customer must be notified immediately from your distributor location.

Export Distributors are to submit warranty claims in the usual manner making reference to this recall number.

Export Distributors are expected to provide full cooperation and follow-up with respect to this important subject matter. If you have any questions or need further assistance, please contact the Regional Service Manager at your regional office.

International Motors, LLC*
International Motors, LLC d/b/a International Motors
USA LLC in Illinois and Ohio.