

ATTENTION: Mercedes-Benz Dealer Principals, General Managers, Sales Managers, Service Managers & Parts Managers

Safety Recall Launch Notification

March 27, 2026

Campaign #	NHTSA ID	Description	Replace High Voltage Battery – Wave 4
2025080004	25V487	25P5490109	

Campaign Details

Total Recall Population	154 (Wave 1+2+3) + 50 (Wave 4) = 204	Model(s)/ Platform(s)	EQB (243 platform)
Vehicles in Dealer Inventory	0		
Model Year(s)	2022-2023		
Issue	Mercedes-Benz AG, the manufacturer of Mercedes-Benz vehicles, has decided that a defect exists on certain subject vehicles. The busbar screw connection within the high-voltage battery might not meet current production specifications. In this case, the screw head might not sit flush on the busbar, which could lead to sporadic interruption of power transmission and a sudden loss of vehicle propulsion without warning. As a result, the risk of a crash might be increased.		
What We're Doing	MBUSA will conduct a voluntary recall. The high-voltage battery on the affected vehicles will be replaced.		
Remedy	The remedy is available and can be ordered at this time. Due to the remedy part logistics, dealers must order parts in advance of scheduled service appointments to reduce downtime for the customer. Parts provided will be VIN-specific. Until the remedy has been performed, vehicle maximum state of charge should be reduced to 80%, and when not in use, the vehicle should be parked outside.		
Launch Date	Affected Wave 4 VINs will be flagged in VMI as “OPEN” on Friday, March 27, 2026. The campaign will be visible on the www.NHTSA.gov website and may generate questions from customers.		
Approximate Customer Notification Date	Friday, April 10, 2026 Final customer letters can be found at MBUSA.com/recall or NHTSA.gov at the time of mailing.		
Warranty Claim Notice	Please note the campaign will close after the warranty claim has been submitted. This change can take at least one day to reflect in Netstar VMI.		

Given this notice, it is a violation of federal law for a dealer to sell or lease any new vehicle in dealer inventory covered by this notification until the vehicle has been repaired. Violations of federal law may result in civil penalties.

- Loaner and demonstrator vehicles may continue to be driven, but must not be retailed until repaired.
- Once the remedy is available, vehicles will be flagged as “OPEN” and Work Instructions will be available.
- As a matter of normal service process, please check for other repair measures that might be applicable to the vehicle(s).

Additionally, given this notice, it is a violation of federal law for car rental companies to rent vehicles covered by this notification until the vehicle has been repaired. Violations of federal law may result in civil penalties.

While we regret any inconvenience this may cause, MBUSA is determined to maintain a high level of vehicle quality and customer satisfaction. Please refer all customer inquiries to the Customer Care Center at 1-800-FOR-MERCEDES.



Recall Campaign Bulletin



January 2026

TO: ALL MERCEDES-BENZ DEALERS

CAMPAIGN NO.	2025080004
CAMPAIGN DESC.	25P5490109
NHTSA ID	25V487
SUBJECT	Replace High Voltage Battery – Wave 4
MODEL(S)	EQB (243 platform)
MODEL YEAR(S)	2022 – 2023
CAMPAIGN POPULATION	204 = 154 (Wave 1+2+3) + 50 (Wave 4)

Campaign Technical Instructions

Prior to performing this Campaign:

Check the Vehicle Master Inquiry (VMI) to verify this campaign applies to the specific vehicle!

1. Always check for other OPEN campaigns and perform them accordingly.
2. Review the entire campaign bulletin first and perform the procedures exactly as described.

Order No. P-RC-2025080004

Recall Campaign Bulletin

Recall Campaign Bulletin

Recall Campaign Bulletin

Recall Campaign Bulletin

Recall Campaign Bulletin

Primary Parts Information

Qty.	Part Name	Part Number
1	High-voltage battery*	A 243 340 51 03 80
14	Hexalobular head screw***	A 000 990 46 29
2	Locking cap (coolant caps on HV battery side)	A 007 997 90 89
4	Compensating elements***	A 243 342 02 00
As required	Coolant	**

* High-voltage battery orders **MUST** be submitted via **Star Support Case (Group: New Model Campaign and Recall Review MBUSA)**, and the Vehicle Identification Number (VIN) **MUST** have a corresponding **TIPS Case**.

* The **high-voltage battery Part Number listed above is the ONLY acceptable part number for this repair!** Any changes to this will be reflected in this document.

** The replacement parts must be determined according to the equipment variant for the vehicle identification number via the parts process in XENTRY Portal.

*** Single-use fasteners

 Small parts such as screws, lock nuts, sealing rings, cable ties, fluids, sealant, etc. are not listed in the parts list. The required small parts are taken into account in the budgeting.

Workshop Equipment Information

W 000 588 25 62 00 - Lifting platform – WS01.00-P-0264A †
W 169 589 02 31 00 - Vehicle hoist securing tool – WS00.00-P-0281Z
W 000 588 19 31 00 - Load-carrying device – WS54.00-P-0094B ††
W 000 588 20 31 00 - Sling gear – WS54.00-P-0095B
W 000 588 25 31 00 - Crane vehicle – WS54.00-P-0128B

† Inspect workshop lift table to ensure wheels and casters are in good operating condition.

†† In combination with W 000 588 20 31 00 sling gear and portal crane or forklift.

†† In combination with W 000 588 25 31 00 Crane vehicle (provided that no forklift, portal crane or similar is available).

In the event of a Manual High-Voltage Power down:

W 242 589 00 63 00 – Test adapter
W 000 589 94 63 00 – Test adapter
600V FLUKE T+PRO Electrical Tester

⚠ This repair MUST be completed by a technician qualified to work on high-voltage on-board electrical systems. See SI00.00-P-0156A for information and qualifications. ⚠

Work Procedure

1. Replace high-voltage battery.

i For basic data, see **AR47.70-P-0002EQB**.

NOTE: The following document serves as a reference guide for the comprehensive repair outlined in AR47.70-P-0002EQB. All torque measurements must be performed in accordance with WIS specifications.

REMOVE

1. Visual inspect battery **AR47.70-P-0017EQA**
2. Deenergize high-voltage on-board electrical system **AR47.70-P-1000EQA**
3. Secure on lift with **Vehicle hoist securing tool (W 169 589 02 31 00)**.

i The vehicle lift pads should be removed prior to installing the securing tool.

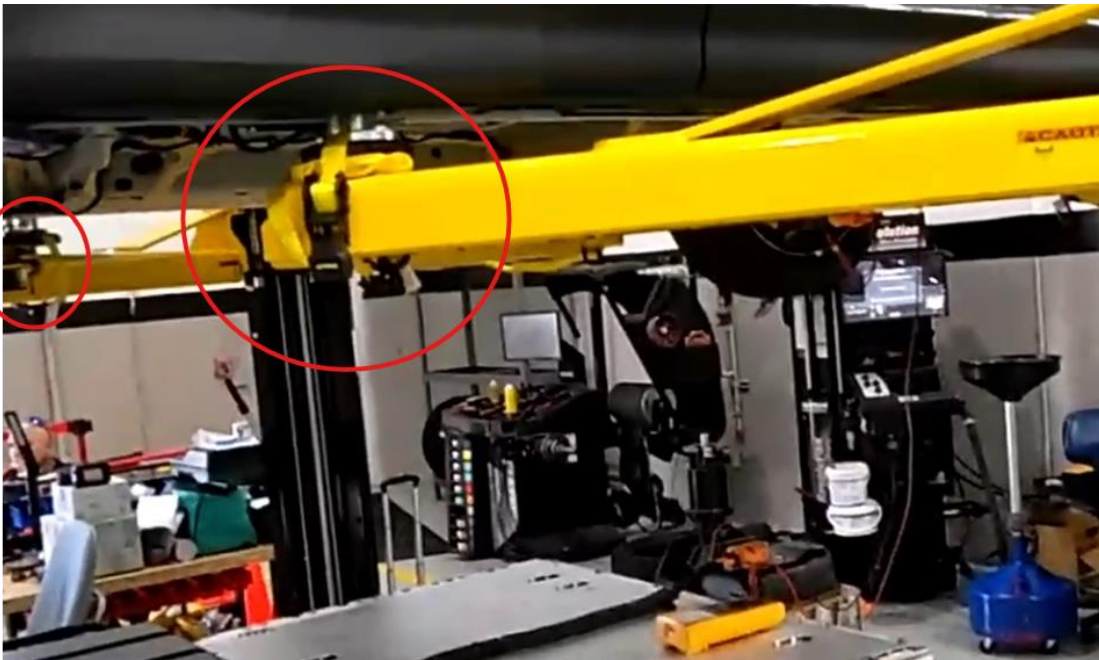

Figure 1

NOTE: Pay close attention to vehicle position when mounting on lift; the drivers' door may contact the lift arm due to lower profile mount points. If lift pads are not in the right position, it is extremely difficult to remove the underlining.

IMPORTANT: Once secured on lift, position Lifting platform (W 000 588 25 62 00) beneath the vehicle to visually verify level on lift. If the platform does not align flush with the vehicle, readjust mounting points before continuing!

CHECK

4. Transport assessment **AD00.00-P-2000-06MFA**
5. Check HV Battery with XENTRY Diagnosis, **print out a copy of HV Control Unit log**
 - Once CUL is printed, disconnect 12 V battery negative terminal to prevent coolant pumps auto-run!
6. Remove underfloor panels - **AR61.30-P-1001EQA**
7. Remove rear axle trim - **AR61.30-P-0050EQA**
8. Disconnect coolant lines (**Figure 2, 1**) – clamp off hoses as close to HV battery as possible!
 - i** Keep coolant inside the battery to ensure the anti-freeze mix is still in there for corrosion protection!
9. Remove coolant lines from HV battery **AR08.50-P-0018-01EQ**

10. Open clamps on coolant lines (**Figure 2, 1**) and drain coolant
11. Unclip HV lines at bracket (**Figure 2, 13**) and remove bracket (**13**)
12. Remove HV plugs of HV lines (**Figure 2, 2, 3 & 4**) **AR47.70-P-0005-01EQ**

NOTE: Pay close attention to electrical connector Figure 2, 4. The locking mechanism can break if not fully released and will require the harness to be replaced. This will not be covered under this campaign.

13. Release and disconnect electrical connector (**Figure 2, 5**).

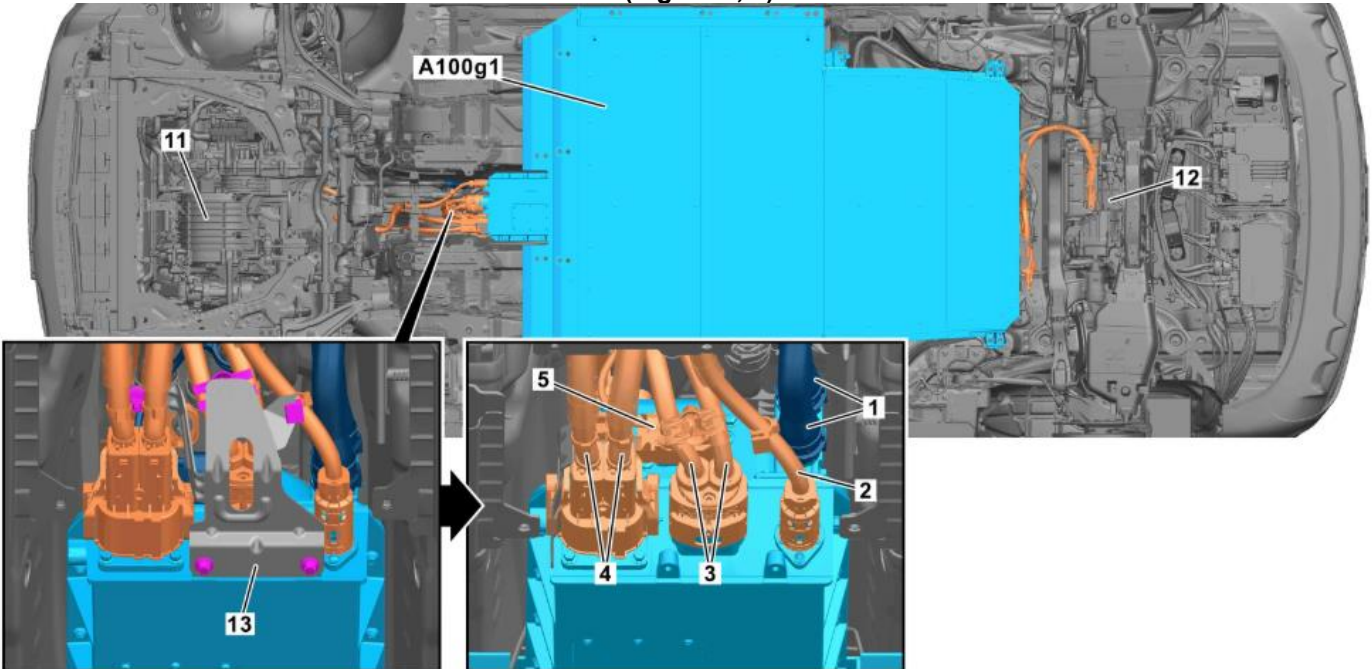

Figure 2

14. Remove HV plug (**Figure 3, 17**), expose HV harness (**Figure 3, 16**) and guide out via rear axle towards the front.
15. Remove holder (**Figure 3, 6**) then HV plug (**Figure 3, 7**) at rear axle drive unit (**Figure 3, 12**).
16. Release and disconnect electrical connector (**Figure 3, 15**).

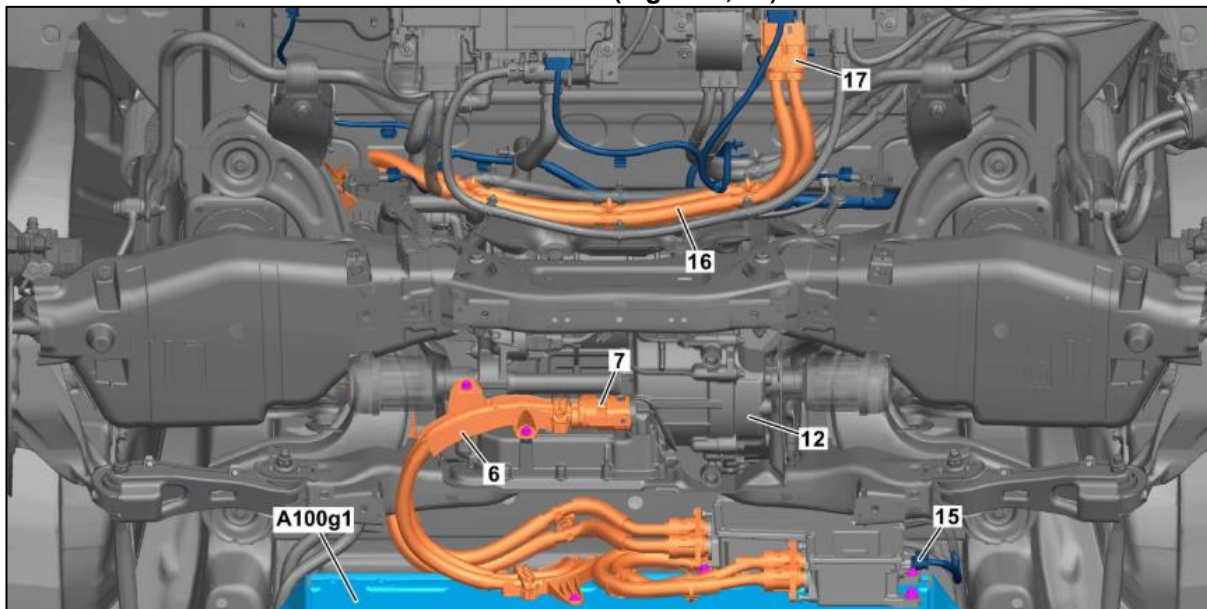

Figure 3

17. Position **lift table 000 588 25 62 00** centrally under HV battery
18. Raise lift platform until HV battery is resting centrally on lift table.
- i** To assist with installation, mark the lift table wheel locations with tape.
19. Unscrew **14 hexalobular screws (Figure 4, 9a-9n)** – *Single-use fasteners, must be replaced.*
- i** **Note the bolt hole positions prior to removal as this may vary from WIS.**

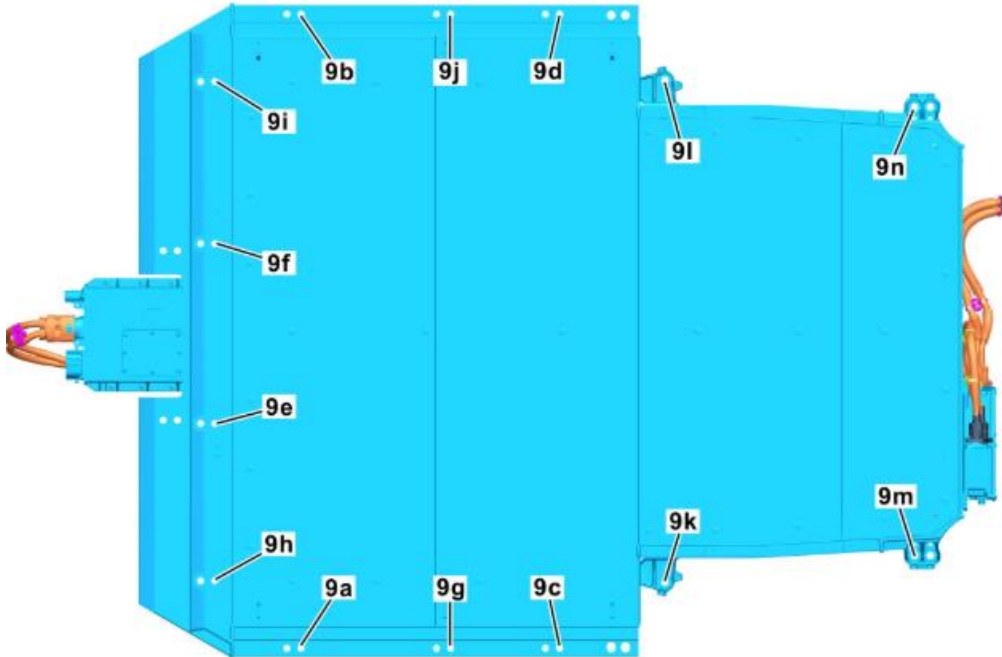

Figure 4

20. Lower lift table slowly
- i** **Pay close attention that no electrical lines or other components are in the way.**
21. Remove **compensating elements (Figure 5, 10)** – *Single-use fastener, must be replaced.*
- i** **Note the rear compensating element position prior to removal as this may vary from WIS.**
22. Remove HV harness (Figure 5, 18) from HV battery (with code M0005 4MATIC)

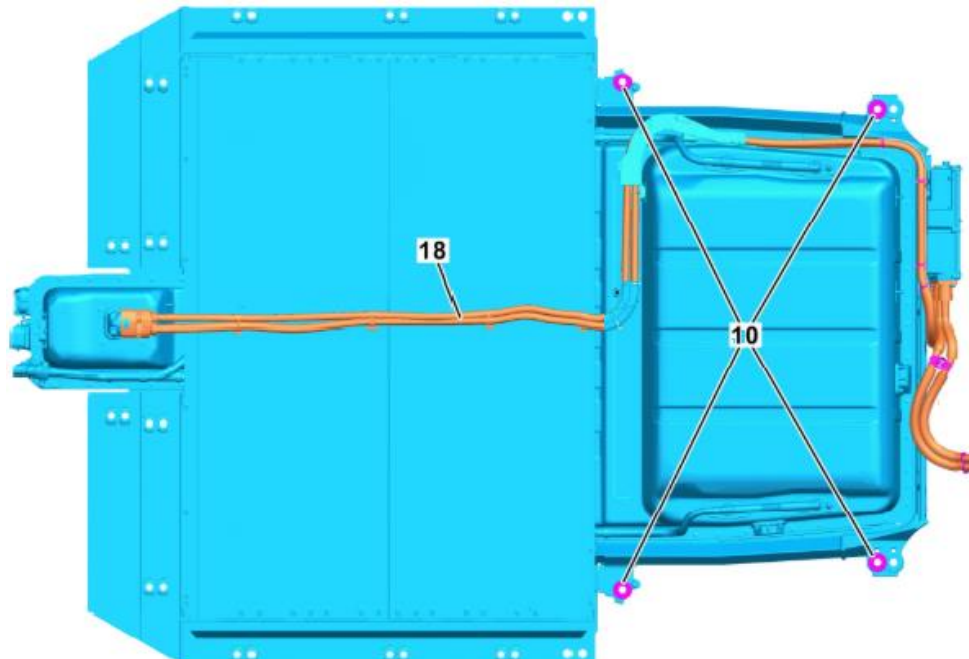

Figure 5

23. Remove HV disconnect device (N171) for battery charger.

i Only with code 847 (3rd seat row)

i For basic data, see AR47.70-P-1600EQB.

- Remove screws (Figure 7, 10), and guide electrical line duct (Figure 7, 11) out of rear axle.
- Remove HV Battery (Lower lift table).
- Remove nuts (Figure 8, 7) and screws (Figure 8, 6).
- Remove HV harness of HV disconnect device (Figure 6, N171) from HV battery (A100).
- Remove screws (Figure 6, 3) and remove HV disconnect device (Figure 7, N171) together with HV harness (Figure 7, 12).

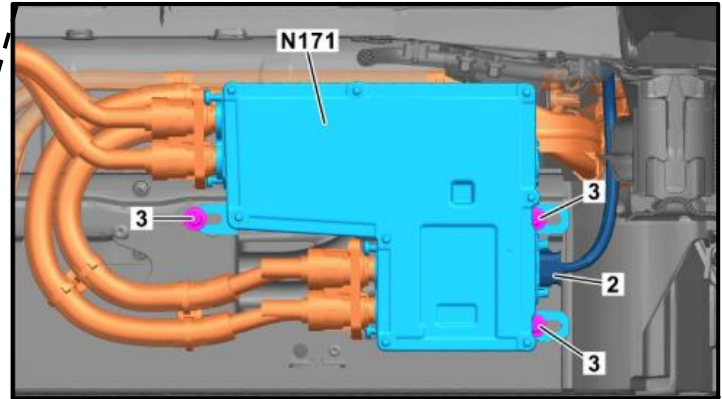

Figure 6

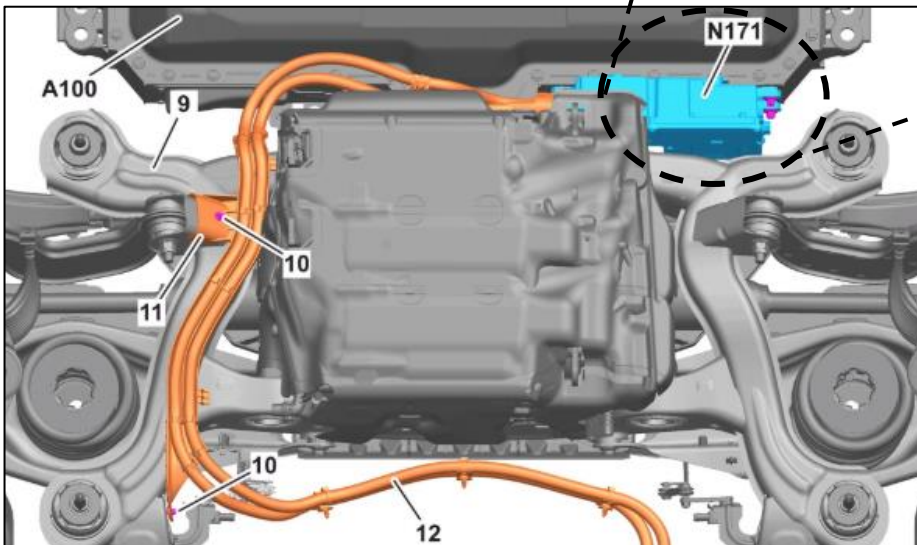

Figure 7

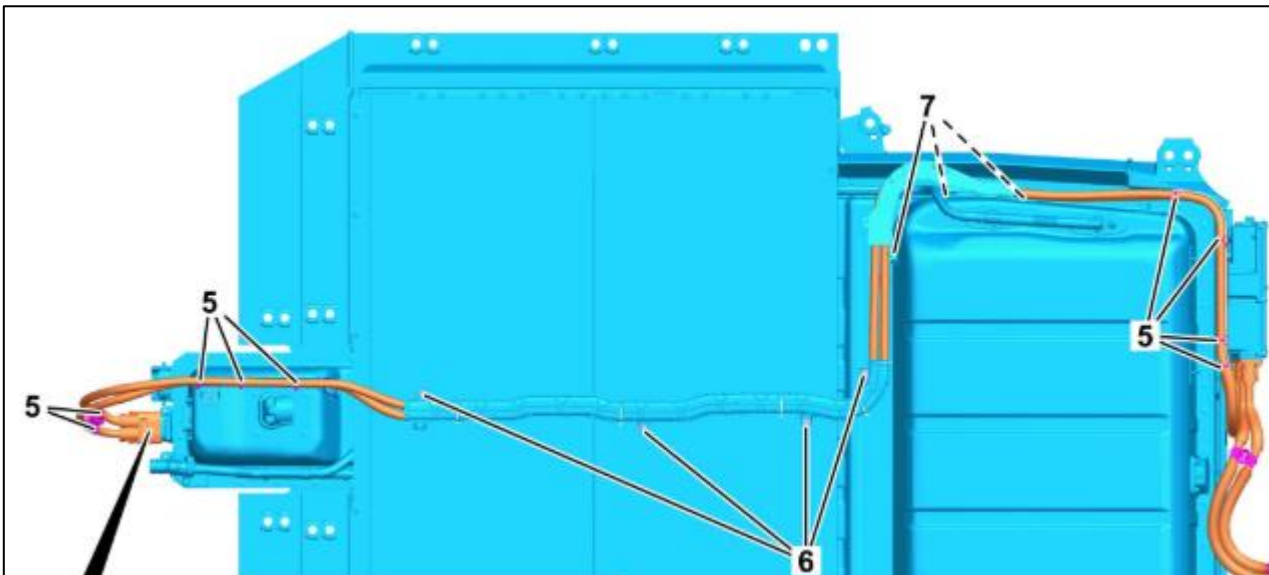

Figure 8

CLEAN

24. Clean surface of HV battery with lint-free rag
NOTE: If coolant gets onto the surface of the HV battery, immediately remove coolant!

CHECK

25. Check previously non-visible areas of housing of HV battery **AR47.70-P-0017-01A**
 26. Attach lifting device to HV battery **AR47.70-P-0002-00EQA**
 - **000 588 19 31 00 Load-carrying device**
 27. Put HV battery in transport case with load-carrying device
 28. Pack HV battery for proper return – Store in a proper location until transportability has been determined.

NOTE: A used high-voltage battery may only be handed over for transportation when the transportability has been determined and documented, and the high-voltage battery has been properly packed.

Include the following completed documents for high-voltage battery return in TIPS case and Paperless XD:

- Analysis sheet for transportability of high-voltage batteries
- Control unit log for high-voltage battery from diagnostic system.

INSTALL

29. Screw drifts in two of the outer fastening points of HV battery to body using the two long drifts
 30. Attach load-carrying device to new HV battery, then remove from transport case and position it on lift table:
 - **000 588 19 31 00 Load-carrying device**
 - **000 588 25 62 00 Lift table**
 31. Align HV battery lift table in marked location so that drifts are located above outer attachment points of HV battery
 32. Carefully lift lifting platform until high-voltage battery is in contact with vehicle body.
 ⓘ Aid of a helper required.
 33. Install disconnect device (N171) for charger of HV battery **AR47.70-P-1600EQB**
 ⓘ Only with code 847 (3rd seat row)
 34. Attach HV wiring harness to HV battery
 35. Install new compensating elements
 36. Tighten new screws (Figure 4, 9a–9j) slightly by hand, remove drifts, torque to specification in alphanumeric order.
BA47.70-P-1003-01A
 37. Position new screws (Figure 4, 9k–9n) in compensating elements, torque to specification in alphanumeric order.
BA47.70-P-1003-01A
 ⓘ Catch tabs of compensating elements must remain in starting position during positioning. Lift function of compensating elements is otherwise not present.
 38. Install rear electrical connector
 ⓘ Only with code 847 (3rd seat row)
 39. Install holder (Figure 3, 6)
 40. Guide high-voltage wiring harness and connector to rear axle plug (Figure 3, 17)
 ⓘ Only with code 847 (3rd seat row)
 41. Attach high-voltage plugs of high-voltage lines (Figure 2, 2, 3, 4) and torque to specification. **BA47.70-P-1012-01A**
 42. Install bracket for high-voltage electrical connectors. **BA47.70-P-1021-01A**
 43. Attach coolant lines to high-voltage battery
 44. Fill coolant for low-temperature circuit of high-voltage battery. **AR20.00-P-1151EQA**
 45. Visually inspect components for leak tightness.
 46. Install rear axle trim and underfloor paneling
 47. Perform **Initial Startup** of high-voltage battery following XENTRY Diagnosis. **AR47.70-P-1000EQA**

Warranty Information

i **Note:** *The following allowable labor operation should be used when submitting a warranty claim for this repair:*

Damage Code	Operation Number	Description	Labor Time (hrs.)
54 901 09	11-0025	Replace High-voltage battery	ZM

i **Note:** *Always check Xentry Operation Time (XOT) for the current OP-Code times. Labor times are subject to change and updates may not be reflected in this document.*

- i** **Include the following completed documents for high-voltage battery return in TIPS case and Paperless XD:**
- Analysis sheet for transportability of high-voltage batteries
 - Control unit log for high-voltage battery from diagnostic system.