

# Safety Recall

## Code: 93AA



**Subject**  
**Document History**

**High-Voltage Battery**

Date	Summary
09/25/2025	Updated HV battery parts ordering and claiming information. <b>CRITICAL REMINDER: BEFORE PERFORMING THE SOFTWARE UPDATE, IT IS ESSENTIAL THAT THE BATTERY EVALUATION IS CARRIED OUT FIRST, WHEN APPLICABLE.</b>
09/19/2025	Added repair availability for ALL criteria. Updated parts tables, claiming instructions and work instructions.
07/10/2025	Updated vehicle counts Updated criteria information
05/22/2025	Updated cell module criteria in parts claiming section for Q5 model.
04/22/2025	Original publication

**Affected Vehicles**

Country	Beginning Model Year	Ending Model Year	Vehicle	Vehicle Count
USA	2022	2022	A7 PHEV	10
USA	2021	2024	Q5 PHEV	20,191
CAN	2022	2022	A7 PHEV	7
CAN	2022	2024	Q5 PHEV	695

Check Campaigns/Actions screen in Elsa on the day of repair to verify that a VIN qualifies for repair under this action. Elsa is the only valid campaign inquiry & verification source.

- ✓ Campaign status must show "open."
- ✓ If Elsa shows other open action(s), inform your customer so that the work can also be completed at the same time the vehicle is in the workshop for this campaign.

**Problem Description**

In rare circumstances the high-voltage battery modules may experience a thermal overload possibly resulting in smoke or fire. Defective high-voltage battery cell modules may overheat, increasing the risk of a fire.

**Corrective Action**

Install an advanced onboard diagnostic software that will detect potential issues with the performance of the battery modules and alert the driver before problems may occur.

When necessary, certain vehicles will have the high voltage battery evaluated.

Certain vehicles also have pre-identified batteries or cell modules that require replacement.

**Precautions**

Owners are instructed not to charge the vehicle from external sources or via the combustion engine until the recall remedy software has been installed.

**Code Visibility**

On December 03, 2024, the campaign code was applied to affected vehicles.

**Owner Notification**

Owner notification began in April 2025. Repair available owner notifications for those who only received an interim letter will take place in September 2025. Owner letter examples are included in this bulletin for your reference.

**Additional Information**

**Please alert everyone in your dealership about this action, including Sales, Service, Parts and Accounting personnel. Contact Warranty if you have any questions.**

## IMPORTANT REMINDER ON VEHICLES AFFECTED BY SAFETY & COMPLIANCE RECALLS

**New Vehicles in Dealer Inventory:** It is a violation of federal law for a dealer to deliver a new motor vehicle or any new or used item of motor vehicle equipment (including a tire) covered by this notification under a sale or lease until the defect or noncompliance is remedied. By law, dealers must correct, prior to delivery for sale or lease, any vehicle that fails to comply with an applicable Federal Motor Vehicle Safety Standard or that contains a defect relating to motor vehicle safety.

**Pre-Owned Vehicles in Dealer Inventory:** Dealers should not deliver any pre-owned vehicles in their inventory which are involved in a safety or compliance recall until the defect has been remedied.

Dealers must ensure that every affected inventory vehicle has this campaign completed before delivery to consumers.

<b><u>Overview of criteria:</u></b>	
<b>Criteria</b>	<b>Description</b>
SW	Perform software update
S1, S2, ...S*	*th update for new vehicles with criteria SW
WA	No longer used
W1, W2, ...W*	No longer used
Y0	HV Battery evaluation required (offline vehicles or vehicles needing batteries/modules)
YA, YB, ...Y*	*th update for new vehicles with criteria Y0
UN	Perform software update (UNECE vehicles)
01	Replace battery module, position 1
02	Replace battery module, position 2
03	Replace battery module, position 3
04	Replace battery module, position 4
05	Replace battery module, position 5
06	Replace battery module, position 6
07	Replace battery module, position 7
08	Replace battery module, position 8
HV	Replace entire HV battery

Model	Criteria	Order of Work
ALL	SW or SW+S* criteria with no other criteria UN or UN + S* criteria with no other criteria SW + UN + S* criteria with no other criteria <i>Example 1: SW</i> <i>Example 2: SW, S1</i>	Update diagnostic software
ALL	SW and/or UN + Any S* criteria and/or any Y* criteria <i>Example: SW, S1, YA, Y0</i>	<ol style="list-style-type: none"> <li>1. Battery Evaluation</li> <li>2. Battery/module replacement, <i>if necessary</i></li> <li>3. Update diagnostic software</li> </ol>
ALL	SW and/or UN + Any S* criteria and/or any Y* criteria + 01 through 08 <i>Example: SW, Y0, 05, 07</i>	<ol style="list-style-type: none"> <li>1. Battery Evaluation</li> <li>2. Battery/module replacement</li> <li>3. Update diagnostic software</li> </ol>
ALL	HV + Y* criteria (or any other criteria) <i>Example: HV, Y0</i>	<ol style="list-style-type: none"> <li>1. Replace HV Battery</li> <li>2. Update battery regulation control module software</li> </ol>

## Parts Information (if necessary)

### Q5 MODELS - COMPLETE BATTERY REPLACEMENT

Applies to vehicles assigned criteria HV, or vehicles requiring complete HV battery replacement as a result of the HV battery evaluation

Criteria	Quantity	Part Number	P.O.C. Part Description
HV or HV + UN	1	80A-915-099- (confirm part number in ETKA)	BATTERY
ALL	4	N -911-922-01	BOLT (battery bracket to body)
	1	5Q0-121-809-A	Sealing (coolant bottle)
	Up to 4	80A-886-373	GROMMET (seat grommet)
	1	8W0-253-141-A	CLAMP (exhaust clamp) (if necessary)
	1	12E-010-006-AA	STICKER
	Up to 8 L	G12 EVO Coolant	

### Q5 MODELS - BATTERY MODULE REPLACEMENT

Applies to vehicles assigned criteria 01 through 08, or vehicles requiring module replacement as a result of the HV battery evaluation

Criteria / Module Pos.	Quantity	Part Number	P.O.C. Part Description
02, 04, 05 or 07	1	4M0-915-591-N	CELL MOD.
01, 03, 06 or 08	1	4M0-915-591-P	CELL MOD.
01 - 08	1/module	4M0-915-474-A	Therm. pad
	4	N -911-922-01	SCREW (battery bracket to body)
	1	5Q0-121-809-A	Sealing (coolant bottle)
	1	4M0-998-587-A	PARTS KIT (small parts kit)
	Up to 4	80A-886-373	GROMMET (seat grommet)
	1	8W0-253-141-A	CLAMP (exhaust clamp) (if necessary)
	1	4M0-915-434	GASKET (upper cover – if damaged)
	4	WHT-008-251	SCREW (separating plate – lower modules)
	As needed	N -107-293-01	TAPE
	As needed	G -052-150-A2	LITH.GREAS
	Up to 8 L	G12 EVO Coolant	
05, 06, 07 or 08	2	N -106-021-01	BOLT (harness connection cover) (if removed)
	1	4M0-915-434-A	GASKET (lower cover – if damaged)
	1	4M0-915-162	SEPARATOR (HV Connection point)
	1	4K0-915-433	GASKET (SX6 to battery – lower modules)
	5	N -907-378-03	BOLT (SX6 to battery – lower modules)
	Up to 4	4M0-915-641	CONNECTOR (lower modules - coolant connection w/ seal)

### A7 MODELS - COMPLETE BATTERY REPLACEMENT

Applies to vehicles assigned criteria HV, or vehicles requiring complete HV battery replacement as a result of the HV battery evaluation

Quantity	Part Number	P.O.C. Part Description
1	4K0-915-099- (confirm part number in ETKA)	BATTERY
8	N -912-189-01	BOLT (battery to body)
6	N -910-423-03	BOLT (SX6 bracket)
1	4KE-121-809-B	Sealing (coolant bottle)
2	N -912-280-01	SCREW (subframe)
7	N -107-486-01	BOLT (crossbrace)
1	12E-010-006-AA	STICKER (if necessary)
1	12E-010-001-G	STICKER (if necessary)
1	12E-010-006-Q	WARN. SIGN (if necessary)
1	12E-010-849-G	STICKER (recycling label) (if necessary)
1	12E-010-006	WARN. SIGN (English) (if necessary)
1	12E-010-006-A	WARN. SIGN (French) (if necessary)
Up to 8 L	G12 EVO Coolant	

### A7 MODELS - BATTERY MODULE REPLACEMENT

Applies to vehicles assigned criteria 01 through 08, or vehicles requiring module replacement as a result of the HV battery evaluation

**See ELSA/ETKA for labor and parts.**

*(NOTE: due to the low population of A7 models and the low expected need for a cell module, the labor and parts will not be listed)*

**Initial Allocation:**

**NO**

There will be no parts allocation.

#### NOTE

Your dealer's Estimated Remaining Repairs by campaign can be found in Parts on Command. Click on "View Campaign List" and review the Estimated Remaining Repairs column.

#### NOTE

Campaign parts should always be ordered as per the parts information in this circular. The ordering system will supersede the part, if applicable.

## Claim Entry Instructions

The labor times listed here may differ from the labor operations and labor times listed in ELSA.

After campaign has been completed, enter claim as soon as possible to help prevent work from being duplicated elsewhere. Attach the Elsa screen print showing action open on the day of repair to the repair order.

If a customer declines campaign work, refer to the “Customer Declines Campaign/Update Repair” section in the Campaign/Update Policy and Procedures Manual.

<b>Service Number</b>	93AA
<b>Damage Code</b>	0099
<b>Parts Vendor Code</b>	002
<b>Claim Type</b>	Sold vehicle: 7 10 Unsold vehicle: 7 90
<b>Causal Indicator</b>	Mark labor as causal if HV battery is OK and if only the software update is performed Mark BATTERY* as causal if the HV battery is replaced Mark CELL. MOD* as causal if a HV battery module(s) is replaced
<b>Vehicle Wash</b>	Do not claim wash under this action
<b>Vehicle Loaner</b>	<b>Software update and HV battery replacement claims ONLY:</b> Do not claim loaner under this action
	<b>Module replacement claims ONLY:</b> See special claiming instructions for rental/loaner claiming. <b><i>NOTE: A 2nd claim must be entered for rental/loaner claiming</i></b>

**Vehicles may have more than one criteria.  
Complete and claim all applicable criteria on one claim.**

**When a vehicle has multiple criteria assigned, it's extremely important that ALL criteria are entered on the claim. Failure to do so could leave the campaign open, which would lead to unnecessary duplicate repairs.**

<b>SOFTWARE UPDATE CLAIMING INSTRUCTIONS</b>			
<b>LABOR</b>			
<b>Criteria</b>	<b>Labor Op</b>	<b>Time Units</b>	<b>Description</b>
ALL	0151 00 10	SEE ELSA	Software update ( <i>setup + battery charger</i> )
	0151 00 60	Time stated on diagnostic protocol (up to 100 TU)	Software update (GFF Operations)
	0689 01 99	10	Perform bus sleep

<b>HV BATTERY EVALUATION CLAIMING INSTRUCTIONS</b>			
<p>Applies ONLY to vehicles assigned Y0, YA, YB, ...Y* that do not have module position criteria assigned.</p> <p><i>Example 1: VIN is assigned SW and Y0 = evaluation necessary</i></p> <p><i>Example 2: VIN is assigned SW, Y0 and 01 = NO evaluation necessary</i></p>			
<b>LABOR</b>			
<b>Criteria</b>	<b>Labor Op</b>	<b>Time Units</b>	<b>Description</b>
Y0, YA, YB, ...Y* that do not have module position criteria assigned.	0150 00 60	Time stated on diagnostic protocol (up to 400 TU)	GFF/Guided functions
	<p><i>NOTE: When a battery or battery module is replaced, the GFF time to complete all operations associated with the repair should be added to labor operation 0150 00 60 and claimed only once.</i></p>		

**Continued on Next Page**

## Q5 ONLY

### COMPLETE BATTERY REPLACEMENT CLAIMING INSTRUCTIONS

Applies to vehicles assigned criteria HV, or vehicles requiring complete HV battery as a result of the HV battery evaluation

Add the following labor and parts when a HV battery is replaced

#### LABOR

	Labor Op	Time Units	Description
	9303 19 50	SEE ELSA	High voltage battery remove+reinstall
	9303 55 50	SEE ELSA	High voltage battery replace
	9303 01 52	SEE ELSA	High voltage battery check (leak test)
	9302 03 50	SEE ELSA	Battery housing measure (Equipotential bonding)
	9310 83 50	SEE ELSA	HV system voltage deactivate and activate (Diagnostic activation HV System)
	9303 01 53	SEE ELSA	Battery module check (classification)
	9136 19 50	SEE ELSA	Sub-woofer remove+reinstall (if equipped)
	7003 19 10	SEE ELSA	Side trim, luggage comp. (rear) remove+reinstall
	2706 89 50	SEE ELSA	Battery charge
	0150 00 60	Time stated on diagnostic protocol (up to 400 TU)	GFF/Guided functions

#### PARTS

Criteria	Quantity	Part Number	Description	
ALL	1.00	12E010006AA	STICKER (if necessary)	
	1.00	5Q0121809A	Sealing	
	Up to 4.00	80A886373	GROMMET	
HV or HV + UN	1.00	80A915099* (per EKTA)	BATTERY*	
ALL	1.00	8W0253141A	CLAMP (if necessary)	
	Up to 40.00 Or Up to 2.00	G 12E100S1 or G 12E050S0	COOLANT (concentrate) Or COOLANT (pre-mix)	USA ONLY
	Up to 40.00	G 12E100S1	COOLANT (concentrate)	CANADA ONLY
	4.00	N 91192201	SCREW, HEX. HD.	

**Continued on Next Page**

## A7 ONLY

### COMPLETE BATTERY REPLACEMENT CLAIMING INSTRUCTIONS

Applies to vehicles assigned criteria HV, or vehicles requiring complete HV battery as a result of the HV battery evaluation

Add the following labor and parts when a HV battery is replaced

#### LABOR

	Labor Op	Time Units	Description
	9303 19 50	SEE ELSA	High voltage battery remove+reinstall
	9303 01 52	SEE ELSA	High voltage battery check (classification)
	9302 03 50	SEE ELSA	Battery housing measure (Equipotential bonding)
	9310 83 50	SEE ELSA	Disable HV system voltage deactivate and activate (Diagnostic activation HV System)
	9352 19 50	SEE ELSA	High-voltage charger remove+reinstall
	9301 01 50	SEE ELSA	Battery module check (classification)
	1938 17 63	SEE ELSA	Coolant drain+fill
	2633 19 15	SEE ELSA	Rear muffler remove+reinstall
	9136 19 55	SEE ELSA	Sub-woofer remove+reinstall (if equipped)
	2706 89 50	SEE ELSA	Battery charge
	0150 00 60	Time stated on diagnostic protocol	GFF/Guided functions
	0151 00 60	Time stated on diagnostic protocol (up to 100 TU)	Software update (GFF Operations)

#### PARTS

	Quantity	Part Number	Description
	1.00	12E010001G	STICKER (if necessary)
	1.00	12E010006	WARN. SIGN (English) (if necessary)
	1.00	12E010006A	WARN. SIGN (French) (if necessary)
	1.00	12E010006AA	STICKER (if necessary)
	1.00	12E010006Q	WARN. SIGN (if necessary)
	1.00	12E010849G	STICKER (if necessary)
	1.00	4K0915099* (per ETKA)	BATTERY*
	1.00	4KE121809B	Sealing

Continued on Next Page

PARTS (cont.)				
	Quantity	Part Number	Description	
	Up to 40.00 Or Up to 2.00	G 12E100S1 or G 12E050S0	COOLANT (concentrate) Or COOLANT (pre-mix)	<b>USA ONLY</b>
	Up to 40.00	G 12E100S1	COOLANT (concentrate)	<b>CANADA ONLY</b>
	7.00	N 10748601	HEX BOLT WITH INTERNAL TORX HEAD	
	6.00	N 91042303	BOLT	
	8.00	N 91218901	BOLT	
	2.00	N 91228001	SCREW	

**Continued on Next Page**

## Q5 ONLY

### HV BATTERY MODULE REPLACEMENT CLAIMING INSTRUCTIONS

Applies to vehicles assigned criteria 01 through 08, or vehicles requiring module replacement as a result of the HV battery evaluation

Add the following labor and parts when battery module(s) are replaced

#### LABOR

Criteria / Module Position	Labor Op	Time Units	Description
01 - 08	9303 19 50	SEE ELSA	High voltage battery remove+reinstall
	9303 01 52	SEE ELSA	High voltage battery check <i>(leak test)</i>
	9302 03 50	SEE ELSA	Battery housing measure <i>(Equipotential bonding)</i>
	9310 83 50	SEE ELSA	HV system voltage deactivate and activate <i>(Diagnostic activation HV System)</i>
	9136 19 50	SEE ELSA	Sub-woofer remove+reinstall <i>(if equipped)</i>
	7003 19 10	SEE ELSA	Side trim, luggage comp. (rear) remove+reinstall
	9303 01 50	SEE ELSA	High voltage battery check <i>(leak test)</i>
	9301 89 50	SEE ELSA	Battery module charge
	9301 89 53	SEE ELSA	Battery module charge <i>(each additional module)</i>
	9301 01 50	SEE ELSA	Battery module check <i>(classification)</i>
	9310 01 50	SEE ELSA	Disable HV system voltage check <i>(insulation measurement)</i>
	9302 19 50	SEE ELSA	Battery housing remove+reinstall <i>(top cover)</i>
	2706 89 50	SEE ELSA	Battery charge
	0150 00 60	Time stated on diagnostic protocol	GFF/Guided functions
Add for criteria 01 – 04	9301 19 50	SEE ELSA	Battery module remove+reinstall <i>(layer 1)</i>
Add for criteria 05 – 08	9301 19 55	SEE ELSA	Battery module remove+reinstall <i>(layer 2)</i>

**Continued on Next Page**

<b>PARTS</b>				
<b>Criteria / Module Pos.</b>	<b>Quantity</b>	<b>Part Number</b>	<b>Description</b>	
02, 04, 05 or 07	1.00	4M0915591N	CELL MOD.*	
01, 03, 06 or 08	1.00	4M0915591P	CELL MOD.*	
01 – 08	1.00	4M0915434	GASKET (upper cover – if damaged)	
	1.00/module	4M0915474A	Therm. pad	
	1.00	4M0998587A	PARTS KIT	
	1.00	5Q0121809A	Sealing	
	Up to 4.00	80A886373	GROMMET	
	1.00	8W0253141A	CLAMP (if necessary)	
	1.00	G 052150A2	LITHIUM-GREASE	
	Up to 40.00 Or Up to 2.00	G 12E100S1 or G 12E050S0	COOLANT (concentrate) Or COOLANT (pre-mix)	<b>USA ONLY</b>
	Up to 40.00	G 12E100S1	COOLANT (concentrate)	<b>CANADA ONLY</b>
	2.00	N 10602101	HEXAGON SOCKET FLAT HEAD BOLT (if necessary)	
	Up to 1.00	N 10729301	TAPE	
	4.00	N 91192201	SCREW, HEX. HD.	
	4.00	WHT008251	SCREW	
	Add for criteria 05, 06, 07 or 08	1.00	4K0915433	GASKET
1.00		4M0915162	SEPARATOR	
1.00		4M0915434A	GASKET (lower cover – if damaged)	
Up to 4.00		4M0915641	CONNECTOR	
5.00		N 90737803	SOCKET HD. SCREW WITH COLLAR	
4.00		WHT008251	SCREW	

**Continued on Next Page**

## A7 ONLY

### HV BATTERY MODULE REPLACEMENT CLAIMING INSTRUCTIONS

Applies to vehicles assigned criteria 01 through 08, or vehicles requiring module replacement as a result of the HV battery evaluation

**See ELSA/ETKA for labor and parts.**

*(NOTE: due to the low population of A7 models and the low expected need for a cell module, the labor and parts will not be listed)*

## ALL VEHICLES REQUIRING MODULE REPLACEMENT

### LOANER CLAIMING INSTRUCTIONS

<b>Vehicle Loaner (if required)</b>	<b>Enter vehicle loaner claim as a separate (2<sup>nd</sup>) claim</b>		
<b>IMPORTANT</b>	<b>Loaner coverage is allowed only for vehicles with HV battery MODULE replacement</b>		
	<b>Claim Type</b>	7 MO	(letter O, not number 0)
	<b>Service Number</b>	93AA	
	<b>Damage Code</b>	0010	
	<b>Parts Vendor Code</b>	002	
	<b>Criteria</b>	MO	(letter O, not number 0)
	<i>NOTE: Criteria MO must be entered on the vehicle loaner claim. If it is not entered, the campaign will close out completely.</i>		
	<b>Outside Labor Operation</b>	LOAN1600	Enter dollar amount on rental/loaner invoice: <b>US Dealers - \$50 max per day</b> <b>Canadian Dealers - \$60 max per day</b> <b>Maximum of 2 days</b>

## Customer Letter Example (USA)

<MONTH YEAR>  
<CUSTOMER NAME>  
<CUSTOMER ADDRESS>  
<CUSTOMER CITY STATE ZIPCODE>

**This notice applies to your vehicle:** <MODEL YEAR> <BRAND> <CARLINE>, <VIN>

**NHTSA:** 24V898 / 25V080

**Subject: Safety Recall 93AA – High Voltage (HV) Battery**

Dear Audi Owner,

This notice is sent to you in accordance with the National Traffic and Motor Vehicle Safety Act. Audi has decided that a defect, which relates to motor vehicle safety, exists in certain 2021-2024 model year Audi vehicles. Our records show that you are the owner of a vehicle affected by this action.

### **What is the issue?**

The high-voltage battery modules may experience a thermal overload possibly resulting in smoke or fire. Defective high-voltage battery cell modules may overheat, increasing the risk of a fire.

### **What will we do?**

To correct this defect, your authorized Audi dealer will install an advanced onboard diagnostic software that will detect potential issues with the performance of the battery modules and alert the driver before problems may occur. This will be performed free of charge. Vehicles requiring software only will take about an hour to complete.

Additionally, when necessary, certain vehicles will have the high-voltage battery evaluated. Certain vehicles also have pre-identified batteries or cell modules that require replacement. This work will also be performed free of charge. If high-voltage battery evaluation and/or repairs/replacement are necessary, this work can take up to two (2) days to complete once your dealer has parts available to do the work.

Please keep in mind that your dealer may need additional time for the preparation of the work, as well as to accommodate their daily workshop schedule.

### **What should you do?**

Please contact your authorized Audi dealer without delay to schedule this recall work. For your convenience, you can also visit [www.audiusa.com](http://www.audiusa.com) and click on the "Find a Dealer" link to locate a dealer near you and schedule this service.

### **Precautions you should take:**

Owners are instructed not to charge the vehicle from external sources or via the combustion engine until the recall remedy software has been installed.

### **Additional Information**

- If you are the lessor and registered owner of the vehicle identified in this action, the law requires you to forward this letter immediately via first-class mail to the lessee within ten (10) days of receipt.
- If your authorized Audi dealer fails or is unable to complete this work free of charge within a reasonable time, if you have changed your address or no longer own the vehicle identified in this letter, or if you should have any questions about this communication, please contact Audi Customer Experience at 1-800-253-2834 or via our "Contact Us" page at [www.audiusa.com](http://www.audiusa.com).
- If you still cannot obtain satisfaction, you may file a complaint with: The Administrator, National Highway Traffic Safety Administration, 1200 New Jersey Avenue, SE., Washington, DC 20590; or call the toll-free Vehicle Safety Hotline at 1-888-327-4236 (TTY:1-888-275-9171); or go to <http://www.safercar.gov>.
- To check your vehicle's eligibility for repair under this or any other recall/service campaign, please visit the Recall/Service Campaign Lookup tool at [www.audiusa.com](http://www.audiusa.com) and enter your Vehicle Identification Number (VIN).
- If you have previously paid for repairs relating to the condition described in this letter, the enclosed form explains how to request reimbursement. We would be pleased to review your reimbursement request.

We apologize for any inconvenience this matter may cause; however, we are taking this action to help ensure your safety and continued satisfaction with your vehicle.

Sincerely,

Audi Customer Protection

## Customer Letter Example (Canada)

<MONTH YEAR>

<CUSTOMER NAME>

<CUSTOMER ADDRESS>

<CUSTOMER CITY STATE ZIPCODE>

**This notice applies to your vehicle:** <MODEL YEAR> <BRAND> <CARLINE>, <VIN>

**Transport Canada Recall:** 2025-369

**Subject: Safety Recall 93AA – High Voltage (HV) Battery**

Dear Audi Owner,

This notice is sent to you in accordance with the requirements of the *Motor Vehicle Safety Act*. This is to inform you that your vehicle may contain a defect that could affect the safety of a person. Our records show that you are the owner of a vehicle affected by this action.

### **What is the issue?**

The high-voltage battery modules may experience a thermal overload possibly resulting in smoke or fire. Defective high-voltage battery cell modules may overheat, increasing the risk of a fire.

### **What will we do?**

To correct this defect, your authorized Audi dealer will install an advanced onboard diagnostic software that will detect potential issues with the performance of the battery modules and alert the driver before problems may occur. This will be performed free of charge. Vehicles requiring software only will take about an hour to complete.

Additionally, vehicles will have the high-voltage battery evaluated. This will take about an hour to complete. Repairs/replacement (if necessary) can take up to two (2) days to complete once your dealer has parts available to do the work.

Please keep in mind that your dealer may need additional time for the preparation of the work, as well as to accommodate their daily workshop schedule.

### **What should you do?**

Please contact your authorized Audi dealer without delay to schedule this recall work.

### **Precautions you should take:**

Owners are instructed not to charge the vehicle from external sources or via the combustion engine until the recall remedy software has been installed.

### **Additional Information**

- If you are the lessor and registered owner of the vehicle identified in this letter, you shall forward this letter (and any subsequent notice, if applicable) to the lessee within ten (10) days of receipt.
- If your authorized Audi dealer fails or is unable to complete this work free of charge within a reasonable time, if you have changed your address or no longer own the vehicle identified in this letter, or if you should have any questions about this communication, please contact Audi Customer Relations Monday through Friday from 8AM to 8PM EST at 1-800-822-2834 or via our "Contact Audi Canada" page at [www.audi.ca](http://www.audi.ca).
- If you have previously paid for repairs relating to the condition described in this letter, the enclosed form explains how to request reimbursement. We would be pleased to review your reimbursement request.

We apologize for any inconvenience this matter may cause; however, we are taking this action to help ensure your safety and continued satisfaction with your vehicle.

Sincerely,

Audi Customer Protection

## Safety Precautions When Working ON the High-voltage System (additional information is also available in the ELSA Repair Manual)

### DANGER

#### **Extremely dangerous due to high voltage.**

- The high-voltage system is under heavy voltage. Severe bodily injury or death by electrocution or electric arcs is possible.
- When working on the high-voltage system the high-voltage system must be de-energized.
- When performing procedures that do not directly affect the high-voltage system, in some cases it is still necessary to de-energize the high-voltage system.
- Pay attention when the high-voltage system must be de-energized. Refer to the Repair Manual
- Have a High-Voltage Technician or a High-Voltage Expert de-energize the high-voltage system.

#### **The electric and magnetic fields are extremely dangerous.**

- There are electric and magnetic fields on the high-voltage system. Death or serious injury are possible due to malfunction of active implants (for example cardiac pacemakers, insulin pumps).
- Persons with active implants may not perform procedures on the high-voltage system.

### WARNING

#### **Risk of injury - motor may start unexpectedly**

It is difficult to determine whether the drive system of an electric vehicle or hybrid vehicle is active. Moving parts can trap or draw in parts of the body.

### CAUTION

#### **Risk of damage to high-voltage wiring**

- Incorrect handling may result in damage to the insulation of high-voltage wires or high-voltage connectors.
- Do not support yourself on high-voltage cables or connectors.
- Never prop tools against high-voltage wiring or high-voltage connectors.
- Never bend or kink high-voltage wiring.
- Observe the coding of the high-voltage connectors when joining them up.

## Safety Precautions When Working NEAR the High-voltage System (additional information is also available in the ELSA Repair Manual)

### DANGER

#### **Extremely dangerous due to high voltage.**

- The voltage levels in the high-voltage system constitute a safety hazard. Danger of severe or fatal injuries from electric shock if high-voltage components or high-voltage wiring are damaged.
- Carry out a visual check of high-voltage components and high-voltage wiring.
- Never use cutting/forming tools or other sharp-edged implements.
- Never perform work using welding, brazing, thermal bonding or hot air in the area of high-voltage components and high-voltage cables.

 **DANGER**

**High voltage increases the risk of fatal injury**

**Electrocution can cause severe bodily or fatal injury.**

- For the following procedures suitable personal protective equipment must be worn.
- For the following steps two correspondingly qualified technicians must be present for the supervision.
- If necessary, a second technician can help the high-voltage expert outside of the hazardous area within their qualification.
- The personal protective equipment (PPE) must be dry and undamaged.

## Repair Overview

Model	Criteria	Order of Work
ALL	SW or SW+S* criteria with no other criteria UN or UN + S* criteria with no other criteria SW + UN + S* criteria with no other criteria <i>Example 1: SW</i> <i>Example 2: SW, S1</i>	Update diagnostic software
ALL	SW and/or UN + Any S* criteria and/or any Y* criteria <i>Example: SW, S1, YA, Y0</i>	4. Battery Evaluation 5. Battery/module replacement, <i>if necessary</i> 6. Update diagnostic software
ALL	SW and/or UN + Any S* criteria and/or any Y* criteria + 01 through 08 <i>Example: SW, Y0, 05, 07</i>	4. Battery Evaluation 5. Battery/module replacement 6. Update diagnostic software
ALL	HV + Y* criteria (or any other criteria) <i>Example: HV, Y0</i>	3. Replace HV Battery 4. Update battery regulation control module software

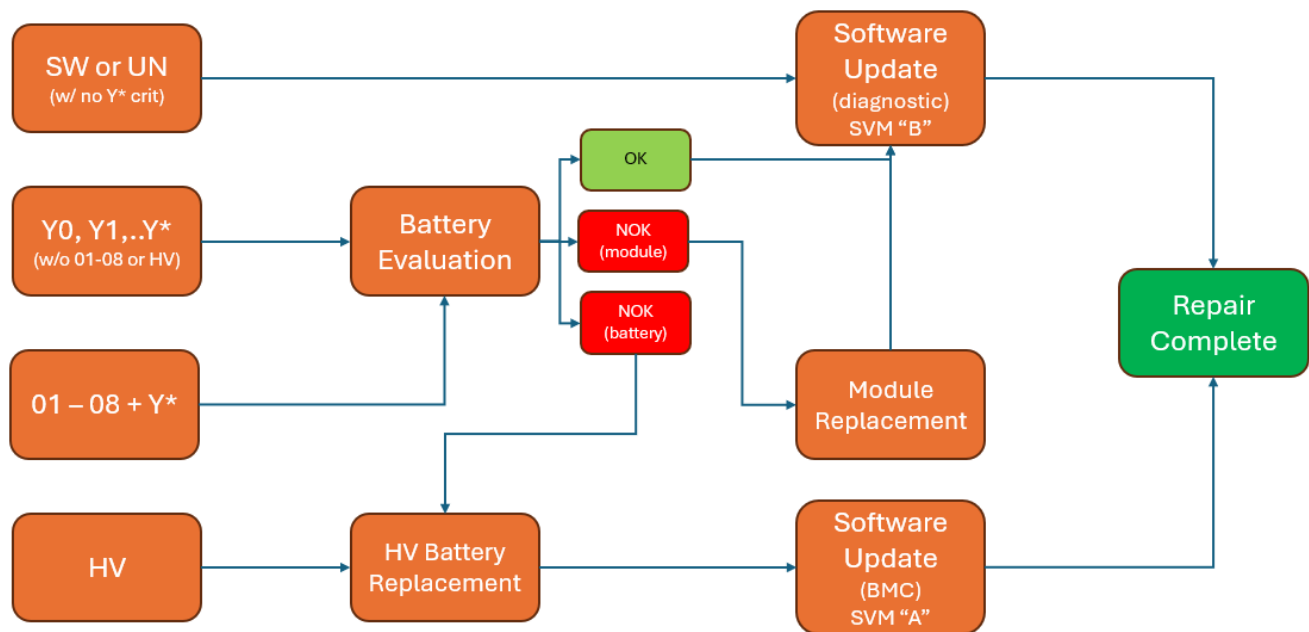



### NOTE

- All vehicles are assigned SW and/or UN.
- If a VIN is assigned HV, no evaluation is required.

 **NOTE**

- These repair instructions may differ from the labor operations and labor times listed in ELSA.
- Damages resulting from improper repair or failure to follow these work instructions are the dealer's responsibility and are not eligible for reimbursement under this action.
- This procedure must be read in its entirety prior to performing the repair.
- Due to variations in vehicle equipment and options, the steps/illustrations in this work procedure may not identically match all affected vehicles.
- Diagnosis and repair of pre-existing conditions in the vehicle are not covered under this action.
- When working during extreme temperatures, it is recommended that the vehicle be allowed to acclimate inside the shop to avoid temperature-related component damage/breakage.

## Required Tools (all vehicles)

 <p>Battery Charger (Max. 105Amp) -VAS5908KIT-</p>	 <p>Diagnostic Tester -VAS6150X/6160X- (or equivalent)</p>
---	--

## Required Tools for HV Battery Removal (if necessary)

### NOTE

Review the ELSA repair manual regarding the required special tools for A7 HV battery removal.

 <p>Hose Clamps - Up To 25mm -3094- (or equivalent)</p>	 <p>Shop Crane -VAS6100- (or equivalent)</p>
 <p>Lift Arm -VAS6100/4-</p>	 <p>Shop Crane - Drip Tray -VAS6208- (or equivalent)</p>
 <p>Hose Clip Pliers -VAS6362- (or equivalent)</p>	 <p>Insulating Mat -VAS6762/44-</p>
 <p>Lifting Eye -VAS691013- (qty 4)</p>	 <p>Shackle (Equivalent to VAS691009A) -VAS691009US- (qty 4)</p>

Continued on next page

 <p>Holding Strap -T40155A- (or equivalent, qty 2)</p>	 <p>Support Feet -T40415-</p>
 <p>Test Adapter - Hybrid Module -VAS6558A-</p>	 <p>Warning Sign - High Voltage -VAS6649-</p>
 <p>Warning Sign - "Do Not Switch On" -VAS6650A-</p>	 <p>Padlock -T40262/1- (from Service Disconnect Lock -T40262-)</p>
 <p>Pliers -T40172C- (or equivalent)</p>	 <p>High Voltage Diagnostics Box -VAS5581A-</p>
 <p>Diagnostic Box - Adapter Cable - VAS5581/1A-</p>	 <p>Pry lever -80-200- (or equivalent)</p>



Continued on next page

 <p>Trim Removal Wedge -3409- (or equivalent, Q5 only)</p>	 <p>Omega Clip Tool -T40280- (or equivalent, Q5 only)</p>
 <p>Cooling System Tester – Adapter -VAG1274/8-</p>	 <p>Cooling System Charge Kit -VAS6096-</p>
 <p>Cooling System Tester -VAG1274B- B/1</p>	 <p>Safety Gloves and Safety Goggles</p>
 <p>Set of Kelvin Clamps and Test Probes -VAS6558A/27- (optional – VAS6558A can also be used)</p>	

**Additional Tools Required for Cell Module Replacement (if necessary)**

**NOTE**

Review the ELSA repair manual regarding the required special tools for A7 cell module replacement.

 <p>T-Handle Hook -3438-</p>	 <p>High-voltage tool set -VAS6762A-</p>
---	--

Continued on next page

 <p>Insulated Torx Wrench Set - 3/8 -VAS691003A-</p>	 <p>Module Jack -T40351-</p>
 <p>Module Balancer -VAS6910- Or -VAS6910A-</p>	 <p>Connection Lead -VAS6910/10-1- (VAS6910 only)</p>
 <p>Connection Lead -VAS6910/10-2- (VAS6910 only)</p>	 <p>Connection Lead -VAS6910/12A-3- (VAS6910 only)</p>
 <p>Cable set (HV) -VAS6910A/24- (VAS6910/A only, part of VAS6910A balancer kit)</p>	 <p>Pole cover set -VAS6910/26- (VAS6910/A only, part of VAS6910A balancer kit)</p>
 <p>Adapter -VAS691005/12-</p>	 <p>Leak-Tight Connector -T40354-</p>

Continued on next page

**Required Shop Materials (if necessary)**

<p>Cleaner D -009-401-04 (shop supply) -OR- 91% Isopropyl Alcohol (locally sourced)</p> <p><b><i>NOTE: Use only 91% Isopropyl alcohol as a cleaner (9% water). Do not use Isopropyl with any additional surfactants (cleaners) or additives (scents).</i></b></p>	<p>Lint Free Towels (locally sourced)</p>
---	---

## Repair Instruction

### Section A - Check for Previous Repair

#### TIP

If Campaign Completion label is present, no further work is required.

Applicable criteria ID(s)	Campaign/Action Status
01 	Open 

**EXAMPLE**

Campaign/Action	Start	Designation
	2015-11-10	W-SERV_ACT -
	2018-12-13	RECALL -
	2017-05-16	A-RECALL -

**EXAMPLE**

- Enter the VIN in Elsa and proceed to the “Campaign/Action” screen.

#### TIP

On the date of repair, print this screen and keep a copy with the repair order.

- Confirm the Campaign/Action is open <arrow 1>. If the status is closed, no further work is required.
- Note the Applicable Criteria ID <arrow 2> for use in determining the correct work to be done and corresponding parts associated.

#### **CRITICAL REPAIR STEP**



All campaigns/actions with a repair available must be performed in order of the Start date <arrow 3>. The oldest should be performed first (unless otherwise noted in the repair instructions).

Model	Criteria	Order of Work	Section of Work Instructions
ALL	SW or SW + S* criteria with no other criteria UN or UN + S* criteria with no other criteria SW + UN + S* criteria with no other criteria	Update diagnostic software	Section E
ALL	SW and/or UN + Any S* criteria and/or any Y* criteria SW or SW + S* criteria and/or any Y* criteria UN or UN + S* criteria and/or any Y* criteria SW + UN + S* criteria and/or any Y* criteria	Battery Evaluation	Section B
		Part replacement, if necessary	(C or D, if necessary)
		Update diagnostic software	Section E
ALL	SW and/or UN + Any S* criteria and/or any Y* criteria + 01 through 08	Module Replacement	Section D
		Update diagnostic software	Section E
ALL	HV + Y* criteria (or any other criteria)	Replace HV Battery AND update BMC software	Section C

**NOTE**

- Damages resulting from improper repair or failure to follow these work instructions are the dealer's responsibility and are not eligible for reimbursement under this action.
- Diagnosis and repair of pre-existing conditions in the vehicle are not covered under this action.

## Section B – Evaluating Need for HV Battery Repair or Replacement

### ! IMPORTANT

**BEFORE PERFORMING THE SOFTWARE UPDATE, IT IS ESSENTIAL THAT THE BATTERY EVALUATION IS CARRIED OUT FIRST.**

### ! NOTE

Analysis of the high-voltage battery will be performed and is required to determine the following:

- If the HV battery is ok.
- If the HV battery requires replacement.
- If any cell modules require replacement and if they do, their positions inside the battery.

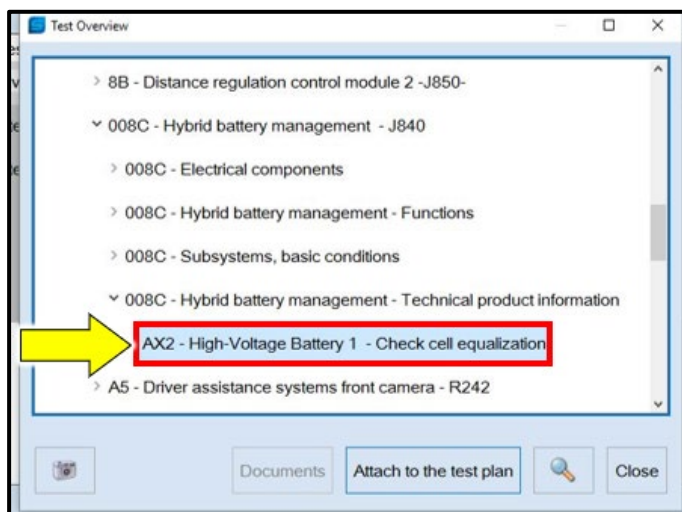

- Connect a battery charger.
- Perform a full diagnostic scan of the vehicle.
- Using operating mode Diagnosis, perform the "Check Cell equalization" test plan <arrow>:
  - **Q5:** Select the test plan tab > Select self-test tab > Body > Electrical Equipment > 01 – Onboard Diagnostic (OBD) capable systems > 008C – Hybrid battery management – J840 > 008C – Hybrid battery management – Technical product information > AX2 – High-Voltage Battery 1 – Check cell equalization > Attach to the test plan.
  - **A7:** Select the test plan tab > Select Self-test tab > Systems with diagnostic capability > 008C - Hybrid Battery Energy Management -J840 > 008C - Hybrid Battery Energy Management - Technical Product Information > AX2 - High-voltage battery 1 - Check cell equalization.
- Follow the on-screen prompts.
- If the test plan states, the high-voltage battery requires replacement:
  - **Proceed to Section C**
- If the test plan states a cell module(s) requires replacement:
  - **Proceed to Section D**
- If the test plan states, the high-voltage battery is OK:
  - **Proceed to Section E**

## Section C – Replacing HV Battery

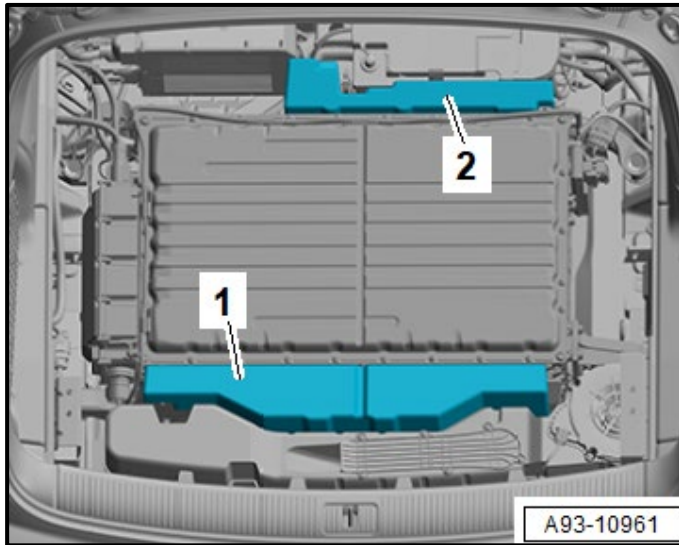

### Replace the HV battery:

#### **CAUTION**

Observe all relevant notes, cautions, and warnings in the repair manual.

#### **NOTE**

(Q5 only): The new HV battery does not require the software update listed in Section E. The new part is already up to date.

#### **NOTE**

The exhaust clamp only requires replacement if damaged during removal.

- Replace the HV battery per the ELSA repair manual:
  - *Repair manual > Engine > 4-Cylinder Direct Injection 2.0L 4V TFSI Engine (EA 888 Generation III) > 93 Electric drive > High-Voltage Battery Unit > Hybrid Battery Unit AX1, Removing and Installing.*

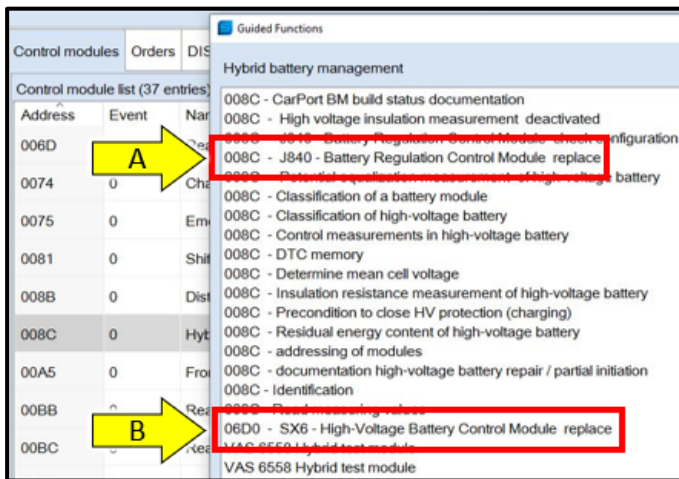

- Reconnect the battery charger if removed.
- **Q5 only:** Under guided functions of DA 008C, perform the replacement test plan for DA 008C <arrow A>:
  - DA 008C > Guided Functions > 008C – J840 Battery Regulation Control Module replace
- Follow the on-screen prompts.
- **Q5 and A7:** Perform the replacement test plan for the SX6 <arrow B>:
  - DA 008C > Guided Functions > 06D0 – SX6 – High-Voltage Battery Control Module replace.
- Follow the on-screen prompts.
- Send the GFF log online when exiting ODIS

**NOTE**

After successful replacement of the HV battery per the repair manual, external charging of the HV battery is no longer prohibited.

**ALL VEHICLES:** Continue with the battery regulation control module software update listed in this section.

**NOTE**

Observe all relevant notes, cautions, and warnings in Section E pertaining to the required pre-conditions that must be met prior to performing a software update.

**NOTE**

After completion of the software update, external charging of the HV battery is no longer prohibited.

## Software update for HV battery control unit after HV battery replacement

- Connect the battery charger.
- Switch off all consumers, air conditioning, heater blower motor, lights, heated seats, etc.
- Ensure the latest version of ODIS is downloaded.
- Ensure diagnostic head is connected to ODIS tester via USB cable.
- Switch the hazard flashers on.
- Move selector lever to P.
- Use operating mode, FLASH.
- Select “SVM – Code Input”.

### IMPORTANT

The following SVM code must **ONLY** be used if the entire HV battery is replaced.

- Enter SVM code **93ABA054** and follow the on-screen prompts.
- Vehicle access = **DoIP**.
- Perform a five-minute bus sleep before exiting the session.
- When exiting the FLASH program, ensure the diagnostic log is sent to GFF Paperless.

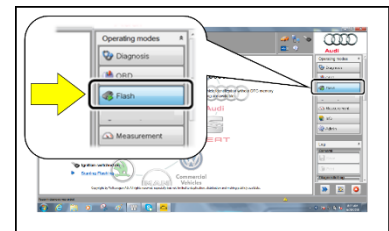

Proceed to Section F

## Section D – Replacing Cell Module(s)

### CRITICAL REPAIR STEP

 **STOP!** 

Before balancing the new cell module, be sure that the vehicle is ready for the repair to be performed.

If possible, the high voltage battery should be de-energized right after recording the voltage reading to avoid possible voltage variations.

Charging the vehicle, driving the vehicle, leaving the ignition on, or running the HVAC can change the high voltage battery voltage.

After reading out the average cell module voltage from the MVBs, avoid moving the vehicle if possible. The vehicle must not be charged or have any electrical consumers used. If this step is not followed, there is a risk that the new cell module will not be balanced correctly resulting in possible faults and having to remove and re-balance the cell module again.

### IMPORTANT

The position and number of cell modules to be replaced is determined by:

- The assigned criteria (01-08).
  - The criteria assigned is in relation to the position of the cell module to be replaced. For example: A vehicle assigned criteria 02 should have cell module #2 replaced.
- The results of the cell module equalization test plan.

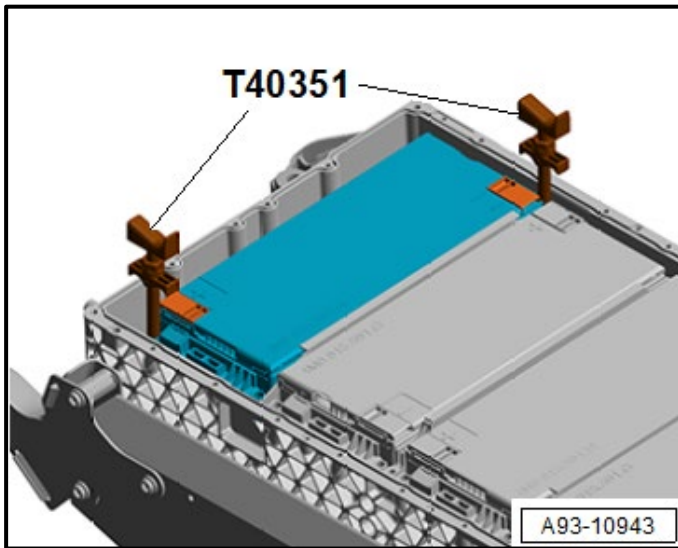

### Replace HV battery cell module:

#### ⚠ CAUTION

Observe all relevant notes, cautions, and warnings in the repair manual.

#### ⓘ NOTE

More than one cell module may require replacement. Please review all assigned criteria and the results of the cell module evaluation test plan (if applicable) prior to starting the repair.

- Replace the affected cell module(s) per the ELSA repair manual:
  - **Removal:** *Repair manual > Engine > 4-Cylinder Direct Injection 2.0L 4V TFSI Engine (EA 888 Generation III) > 93 Electric drive > High-Voltage Battery Components > Battery Module, Removing.*
  - **Installation:** *Repair manual > Engine > 4-Cylinder Direct Injection 2.0L 4V TFSI Engine (EA 888 Generation III) > 93 Electric drive > High-Voltage Battery Components > Battery Module, Installing.*

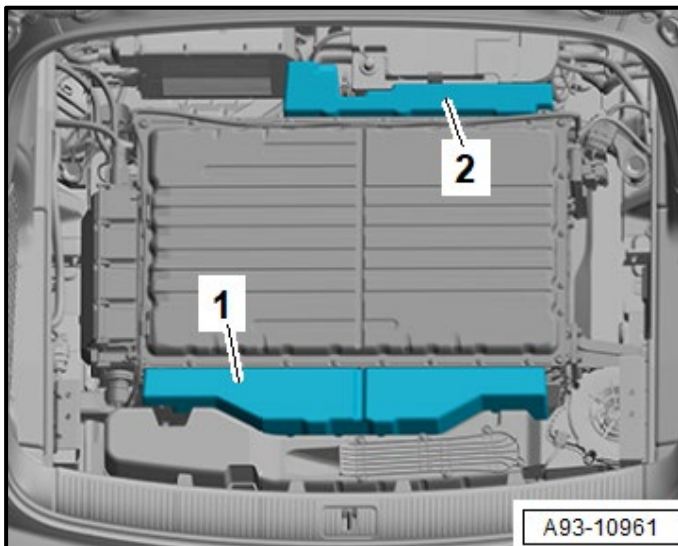

#### ⓘ NOTE

The exhaust clamp only requires replacement if damaged during removal.

- Reinstall the HV battery per the ELSA repair manual:
  - *Repair manual > Engine > 4-Cylinder Direct Injection 2.0L 4V TFSI Engine (EA 888 Generation III) > 93 Electric drive > High-Voltage Battery Unit > Hybrid Battery Unit AX1, Removing and Installing.*

### Proceed to Section E

## Section E – Software Update

### NOTE

**Prior to launching the VAS Diagnostic Tester and starting an update, ensure the following conditions are met;**

- ✓ **The ODIS software is completely up to date.**
  - Refer to the “Current ODIS Service Version” circular found in Elsa2Go Service References.
- ✓ **The battery charger is connected to the vehicle battery and remains connected for the duration of the software update.**
  - Battery voltage must remain above 12.5 volts for the duration of the software update. Failure to do so may cause the update to fail, which could result in damage to the control module. Control modules damaged by insufficient voltage will not be covered.
- ✓ **The screen saver and power saving settings are off.**
  - Failure to do so may result in the tester entering power save mode during the software update, which could result in damage to the control module.
- ✓ **The VAS Diagnostic Tester is plugged in using the supplied power adapters.**
  - Under no circumstances should the tester be used on battery power alone during the software update. Failure to do so may result in the tester powering off during the update, which could result in damage to the control module.
- ✓ **Flash process through “Audi Flashing” not Guided Fault Finding (GFF).**
  - DO NOT USE Guided Fault Finding (GFF) to perform this flash. Using GFF will cause the flash to take longer. Requests for additional time will not be considered.
- ✓ **The VAS Diagnostics Interface MUST ONLY be connected to the tester with a USB cable.**
  - Performing a software update using a Bluetooth or WiFi connection increases the risk of losing connection during the update, which could result in damage to the control module. It also greatly increases the time required to perform the update. Requests for additional time or parts will be denied if the GFF log shows the update was performed using Bluetooth or WiFi.

### NOTE

- All campaign software updates must be completed during a single, standalone ODIS Diagnostic Session. You must fully complete this campaign and send all logs before beginning any other campaigns or operations.
- If there are any ODIS “Hot-Fix” patches installed, they must be removed from the scan tool before beginning this operation. ODIS “Hot-Fix” patches may affect the update process.

### WARNING

Radiator Fan(s) may cycle ON high speed during the Update Process! There is a serious risk that personal injury may result if contact is made with spinning fan blades. Keep hands and all objects away from Radiator Fan(s) during Update Process!

## IMPORTANT

To Update-Programming using SVM, review and follow instructions in Technical Bulletin 2011732: *Software Version Management (SVM) Operating Instructions for the US*, or 2037026: *Working with the Software Version Management (SVM) for Canada*.

The SVM Process must be completed in its entirety, so the database receives the update confirmation response. A warranty claim may not be reimbursed if there is no confirmation response to support the claim.

## NOTE

After completion of the software update, external charging of the HV battery is no longer prohibited.

- Connect the battery charger.
- Switch off all consumers, air conditioning, heater blower motor, lights, heated seats, etc.
- Ensure the latest version of ODIS is downloaded.
- Ensure diagnostic head is connected to ODIS tester via USB cable.
- Switch the hazard flashers on.
- Move selector lever to P.

## IMPORTANT

**Vehicles assigned any Y\* criteria:**

**Before performing the software update, it is essential that the battery evaluation in Section B is carried out first.**

**Vehicles with cell module replacement:**

**Perform the software update AFTER replacing the cell modules (all models).**

- Use operating mode, FLASH.
- Select “SVM – Code Input”.
- Enter SVM code **93ABB054** and follow the on-screen prompts.
- Vehicle access = **DoIP**.
- Perform a five-minute bus sleep before exiting the session.
- When exiting the FLASH program, ensure the diagnostic log is sent to GFF Paperless.

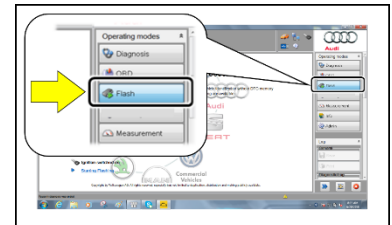

**Proceed to Section F**

## Section F – Campaign Completion Label

### Install Campaign Completion Label

- Fill out and affix Campaign Completion Label, part number CAMP 010 000, next to the vehicle emission control information label.

 **TIP**

Ensure Campaign Completion Label does not cover any existing label(s).

### If the HV battery, one module, or multiple modules required replacement:

- US DEALERS - Proceed to Section G
- CANADIAN DEALERS - Proceed to Section H

## Section G - Parts Return/Disposal – US DEALERS ONLY

### High-Voltage Battery Module(s):

Refer to the latest instructions for high-voltage battery recycling, found in Elsa2Go: *Elsa2Go-> Infomedia->Service References->Electric Vehicle Category ->“HV Battery Recycling Program Guide”*

### All other parts:

Properly store (retain), destroy or dispose of removed parts in accordance with all state/province and local requirements, unless otherwise indicated and/or requested through the Warranty Parts Portal (WPP).

## Section H - Parts Return/Disposal – CANADIAN DEALERS ONLY

### High-Voltage Battery Module(s):

Refer to the latest version of TSB 2062871.

### All other parts:

Properly store (retain), destroy or dispose of removed parts in accordance with all state/province and local requirements, unless otherwise indicated and/or requested through the Part Destruction and Core Disposition Report for Canada.