

SAFETY RECALL

Volvo Trucks North America

Greensboro, NC USA

VOLVO

Release Date	Number	Release	Page
11.2024	RVXX2409	04	1(9)

**Bendix ABS ECU
VAH, VHD, VN, VNRE**

Rev. 4 date: 06/12/2025

- **Changed labor code for claiming purposes**

RECALL INFORMATION

(November 2024)

Volvo Trucks has determined that certain VAH, VHD, VN, and VNRE model vehicles equipped with Bendix EC-80 ABS and towing capability may get an ABS fault due to miscommunication with the trailer. This could impact the ABS/ESP/AEB performance which could result in improper responses from the ABS system. The system may respond incorrectly to the event which could increase the likelihood of a crash.

To ensure these vehicles meet Volvo's strict quality standards, the Bendix EC-80 electronic control unit software will be updated.

VEHICLES AFFECTED

Certain 2020-2025 VAH, VHD, VN, and VNRE vehicles manufactured from May 1, 2019, through October 18, 2024

VEHICLE QUANTITY

There are 133,407 vehicles affected by this recall (115,128 US, 17,844 Canada, and 435 Mexico).

Parts Information

- N/A

Repair Instructions

1. Park the vehicle on level surface.
2. Apply the parking brake.
3. Place the transmission in neutral.
4. Install the wheel chocks.

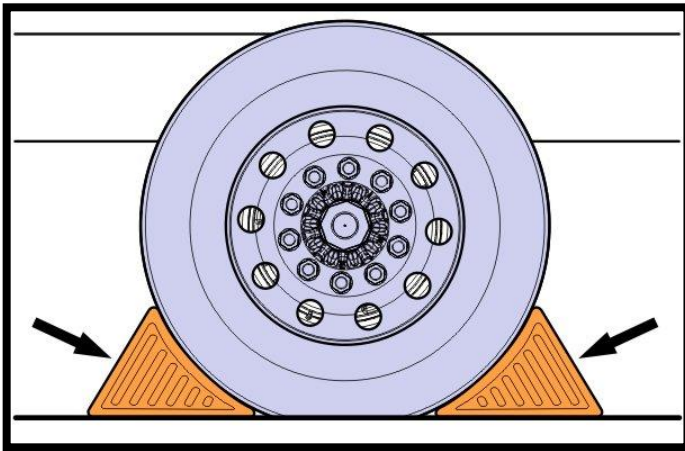

WARNING

ALWAYS ENSURE MOST UP-TO-DATE SOFTWARE VERSION IS DOWNLOADED FROM TRUCKS DEALER PORTAL. YOU MUST **UNINSTALL ALL PREVIOUS VERSIONS BEFORE DOWNLOADING AND INSTALLING NEWEST VERSION.**

Download Bendix's EC-80 Software Update

5. Navigate to Trucks Dealer Portal > Information > Service > Software Downloads. Fleets will contact their Fleet Service Manager for tool download information.

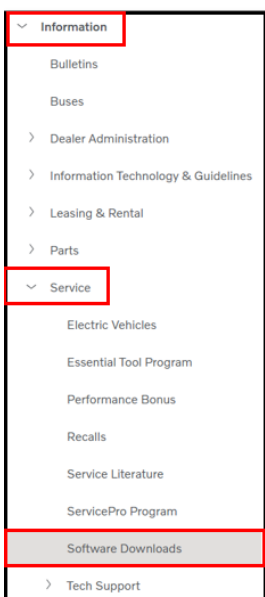

1. Open software downloads

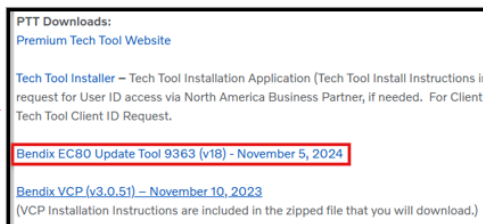

2. Select Bendix EC80 Update tool under PTT downloads.

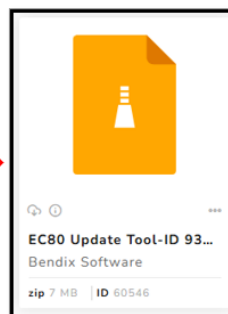

3. Open download by selecting the yellow icon.

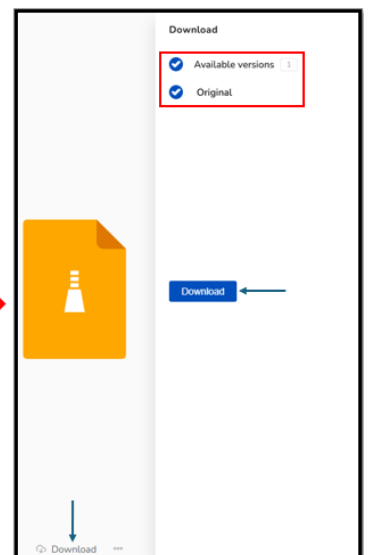

4. Select download, check **original**, click **blue download** option.

6. Download to an accessible location on a Window's 10 or 11 based device.
7. Run the **EC80 Update Tool-ID 9363** installer and follow the instructions in the dialog box of the installer until installation is completed. The EC80 Update Tool-ID 9363 will only need to be installed once. If any issues occur with the install, contact your local IT department.

Step 1. Run the EC80 Setup Wizard.

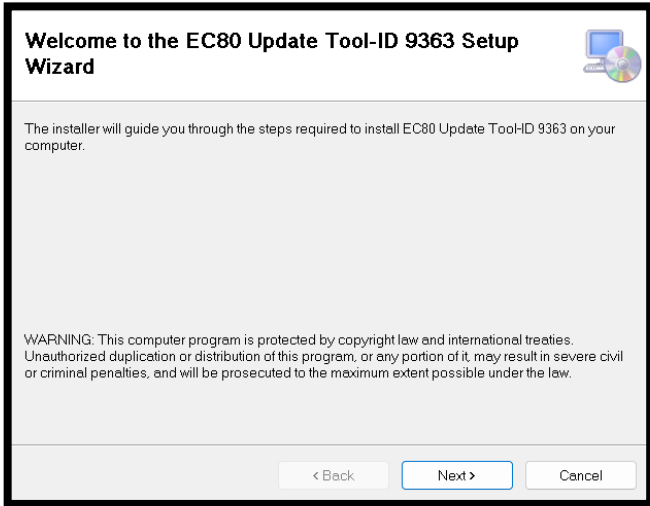

Step 2. Select folder location for EC80 Update Tool.

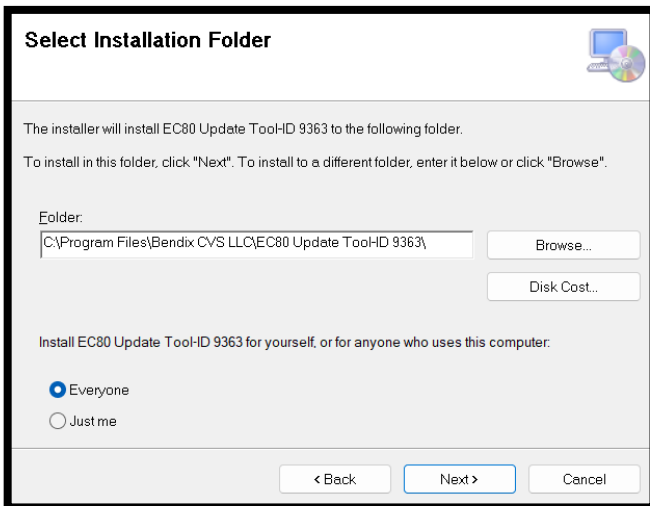

Step 3. Confirm installation of EC80 Update Tool.

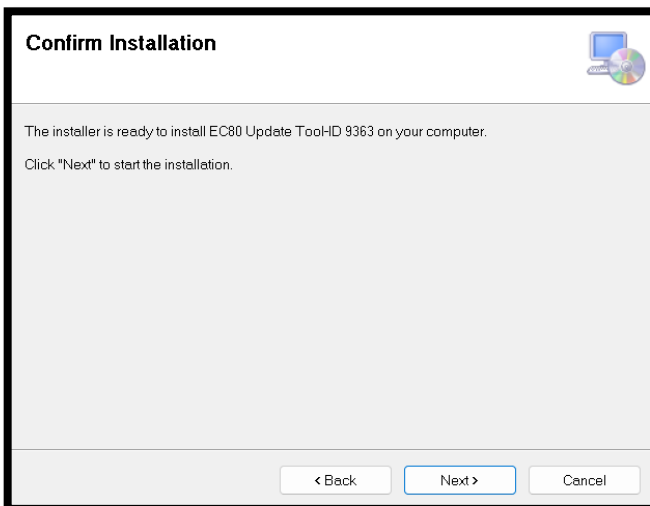

Step 4. Close the Setup Wizard. Installation is complete.

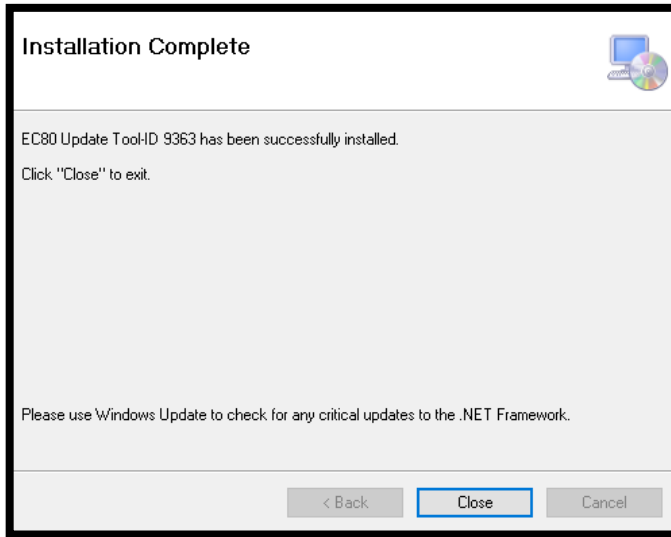

Complete EC-80 Update Procedure

8. Before beginning the update procedure, ensure proper battery voltage of the vehicle.
9. With the engine off, key on the vehicle. Do NOT start or enable traction voltage on the vehicle.
10. Connect the harness from the Window's 10 or 11 device to the vehicle using the 16-pin diagnostic connector.
11. Select and open the **EC80 Update Tool-ID 9363** shortcut.

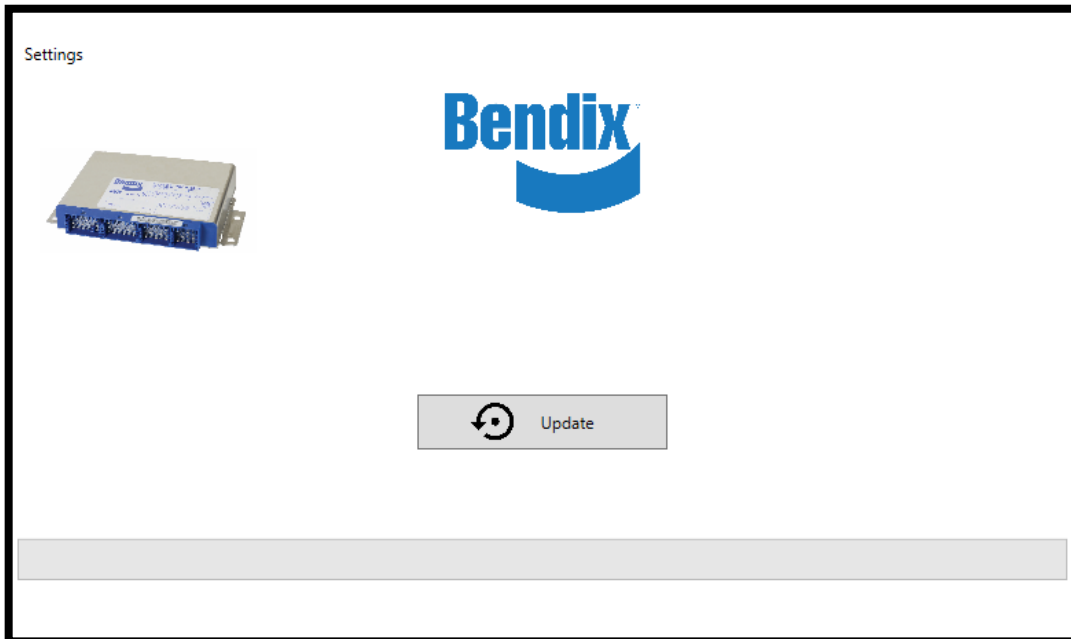
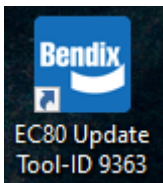

12. Select the settings tab.

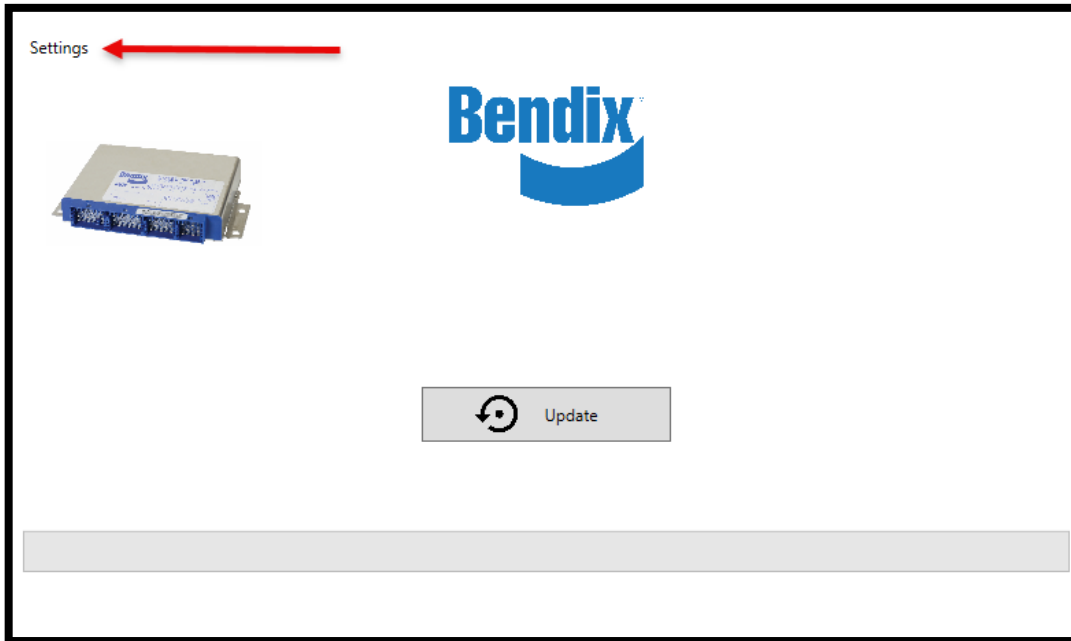

13. Choose the installed diagnostic interface noted by the blue box (Reference compatible list of interfaces below). Select channel 2 with Auto Baud rate from the drop down indicated by the red arrow. Once selected, click **save**.

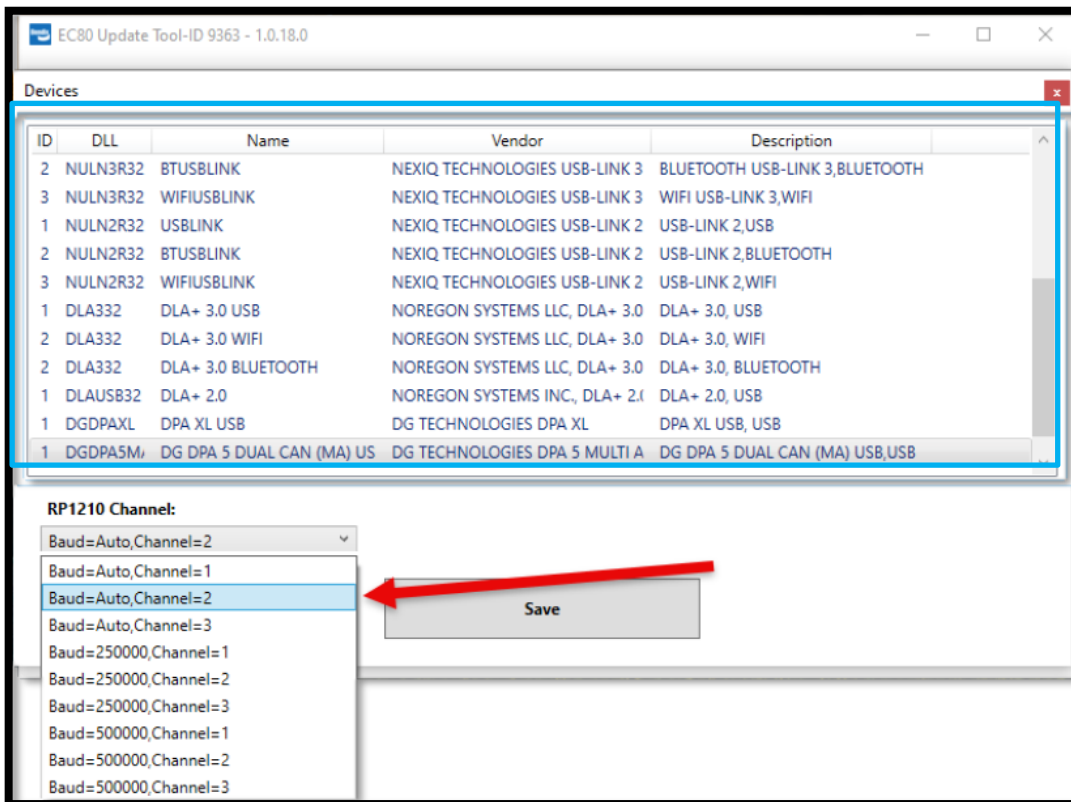

Compatible Interfaces:

- DG Dearborn Protocol Adapter (DPA) 5
- DG Dearborn Protocol Adapter (DPA) XL
- Noregon 2.0
- Noregon 3.0
- Nexiq USB Link 2.0
- Nexiq USB Link 3.0
- Vocom I
- Vocom II Tough
- Vocom II Mini

14. On the Update Tool dialog, click **Update**.

1. If the update is **successful**, the screen will show that the software has been updated and the procedure is complete.

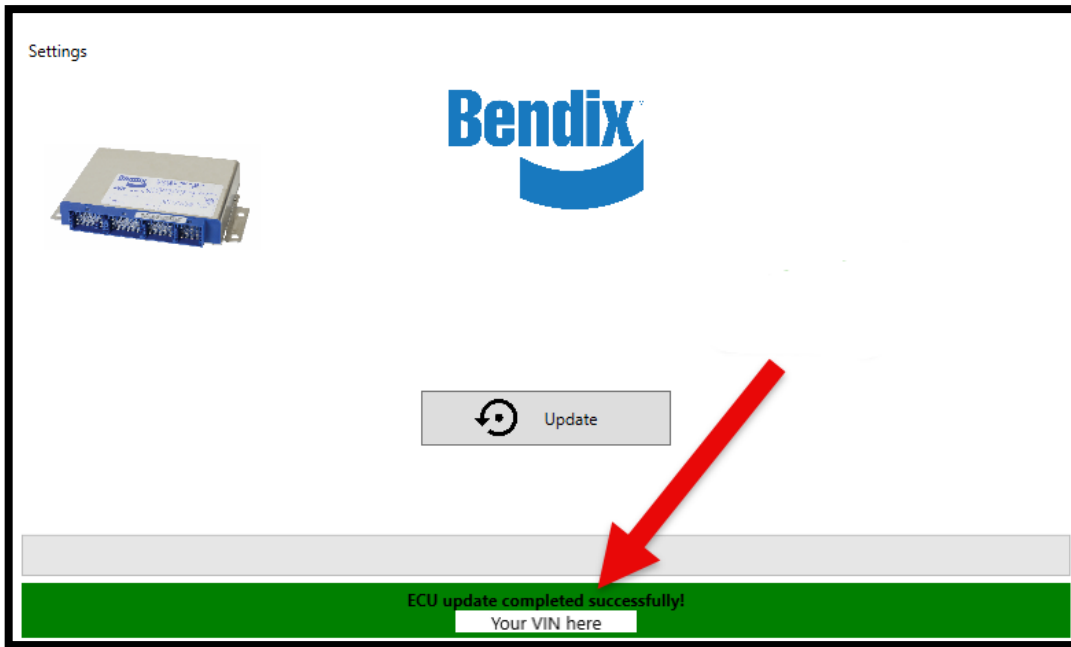

15. If the update has already been performed, no further action is required.

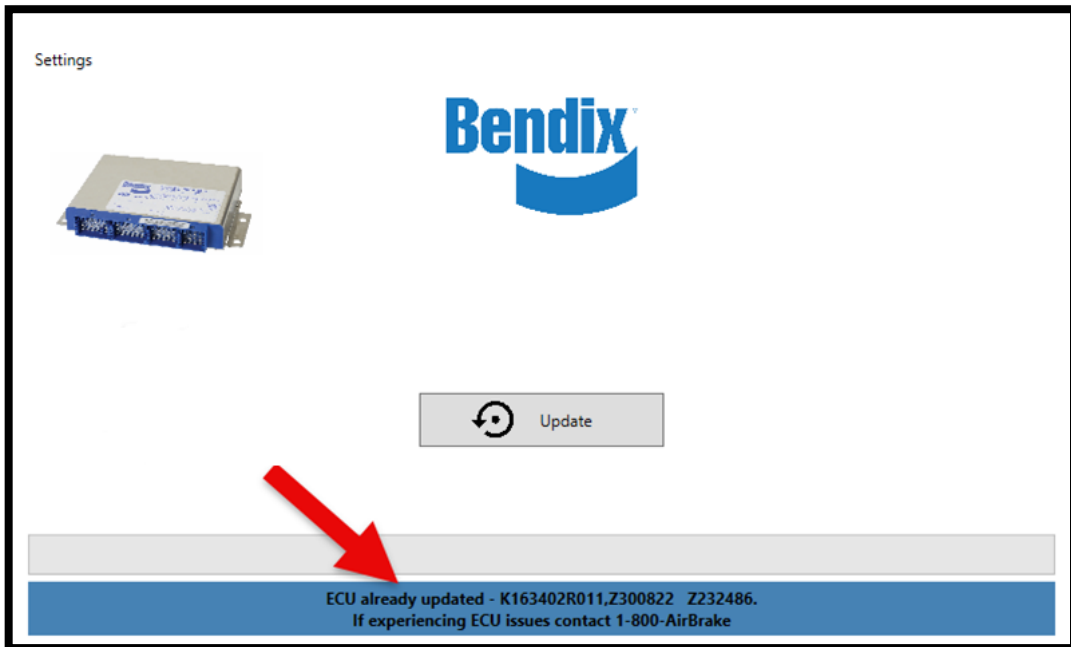

16. If the update **fails or ends in an errored state (examples of errors below)**, the screen will show the software was not able to update. Power cycle the vehicle and restart the update procedure from Step 11.

1. If the detected ECU is not eligible for an update, truck can be released for service.



2. If engine RPM is detected during the procedure, power cycle to ignition only and restart the update procedure from Step 11.



3. If the ECU is not detected, verify the ignition power is ON and/or ensure the correct channel is selected. Verify user is connected to the proper diagnostic connector. Then, restart the update procedure from step 11.

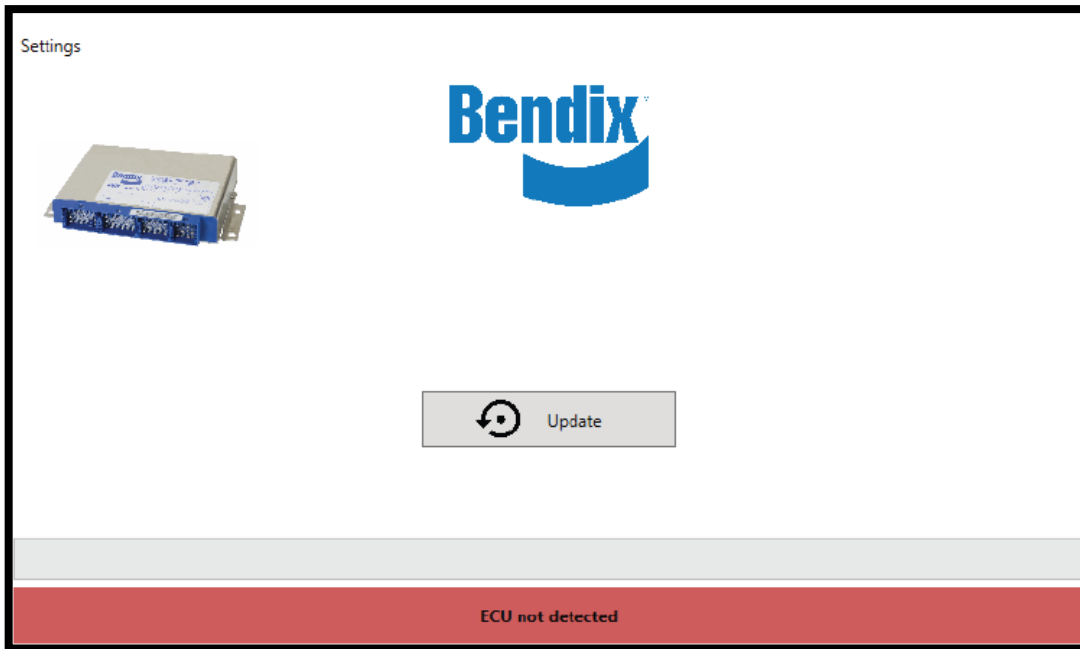

17. Once the Bendix EC-80 software has been updated successfully, clear any Diagnostic Trouble Codes (DTC's) caused by the Bendix EC-80 software update using suitable tools and return the vehicle to service.

REIMBURSEMENT

This repair is covered by an authorized Safety Recall. Reimbursement is obtained through the normal claim handling process.	
	UCHP Reimbursement
Claim Type (used only when uploading from the Dealer Business System)	40
Recall Status	
Vehicle repaired per instructions	1-Modified per instructions
Labor Codes	
1720-16-09-01 Campaign, General	0.3 x 1 (0.3 hrs)
Causal Part	23103632
Authorization Number	C0402

Note: Dealers or the designated representatives are required to perform Safety Recall on all subject vehicles at no charge to the vehicle owner regardless of mileage, age of vehicle or ownership (original purchaser or subsequent purchasers). Whenever vehicles that are subject to a Safety Recall are brought to your dealership for service, it is strongly recommended that every effort be made to perform the recall correction before the vehicle is released to the owner.