

October 8, 2024

Version 2

## Safety Recall: 2023–25 HR-V Steering Gearbox Assembly

Supersedes 24-118 dated October 8, 2024, to revise the information highlighted in yellow.

### AFFECTED VEHICLES

Year	Model	Trim Level	VIN Range
2023–25	HR-V	ALL	Check the iN-VIN status for eligibility.

### REVISION SUMMARY

Under PARTS INFORMATION, the parts table was added.

### BACKGROUND

Due to an improperly produced steering gearbox worm wheel, the wheel can swell during use, reducing the grease film thickness between the worm wheel and worm gear. In addition, the worm gear spring preload was set improperly high, increasing the sliding force between the components. As a result of the reduced grease film thickness and increased sliding force, friction between the worm wheel and worm gear increases.

Increased friction between the worm gear and worm wheel can increase steering effort and difficulty, increasing the risk of a crash or injury.

### CUSTOMER NOTIFICATION

Owners of affected vehicles will be sent a notification of this safety recall.

Do an iN VIN status inquiry to verify eligibility.

Some vehicles affected by this campaign may be in your new or used vehicle inventory.

Failure to repair a vehicle subject to a recall or campaign may subject your dealership to claims or lawsuits from the customer or anyone else harmed as a result of such failure. To see if a vehicle in inventory is affected by this safety recall, do a VIN status inquiry before selling it.

### CORRECTIVE ACTION

Redistribute grease to the worm gear, and replace the end cap, spring, and spring seat in the EPS gearbox assembly.

**CUSTOMER INFORMATION:** The information in this bulletin is intended for use only by skilled technicians who have the proper tools, equipment, and training to correctly and safely maintain your vehicle. These procedures should not be attempted by “do-it-yourselfers,” and you should not assume this bulletin applies to your vehicle, or that your vehicle has the condition described. To determine whether this information applies, contact an authorized Honda automobile dealer.

## PARTS INFORMATION

Due to limited supply, parts will be automatically allocated to your dealership based on availability.

Part Name	Part Number	Quantity
Gearbox Assembly Steering Kit	06530-T20-305	1
Washer Bolt (14X85)	90179-T20-A01	4
Washer Bolt (14x85)	90163-TGH-A01	2
Washer Bolt (14X85)	90130-T20-A00	1
Flange Bolt (14X80)	90108-T20-A00	3
Split Pin (3.0X22)	94201-30220	2
Washer Bolt (10X25)	90159-TBA-A00	3
Self-Lock Nut (12mm)	90215-SB0-003	6
Flange Nut (10mm)	90002-S10-000	2
Flange Bolt (14X50)	90181-TLA-A00	2

## REQUIRED MATERIALS

Part Name	Part Number	Quantity
Hondabond HT	08718-0004	1 tube per 50 vehicles

## TOOL INFORMATION

Tool Name	Tool Number	Quantity
Subframe Adapter	VSB02C00016	1
Ball Joint Thread Protector (12mm)	07AAF-SDAA100	1
Ball Joint Remover (28mm)	07MAC-SL00202	1
Subframe Alignment Pin	070AG-SJAA10S	1

## WARRANTY CLAIM INFORMATION

Operation Number	Description	Flat Rate Time	Defect Code	Symptom Code	Template ID	Failed Part Number
5130A4	Replace the spring seat, spring, and end cap in the EPS gearbox and redistribute the grease to the worm gear (includes VSA relearn, and alignment).	1.8 hr	6JP00	MJU00	A24118A	53620-3W0-A23

Skill Level: Repair Technician

## REPAIR PROCEDURE

1. Remove the steering gearbox/subframe assembly.

NOTE: **Do not** remove the steering gearbox from the subframe.

- Steps 1-10, *Steering Gearbox Removal and Installation*, ([Click Here](#)).

2. Remove the heat shield.

- Step F, *Front Subframe/Steering Gearbox Area* ([Click Here](#))

3. With a clean, damp rag, clean any dirt, mud, or debris around the black cover on the EPS gearbox. While wearing safety glasses, use compressed air to dry the area around the black cover and to remove any debris.

NOTE: Take appropriate steps to ensure that no debris enters the EPS gearbox.

4. Removing the steering motor black cover:

1. Remove the two bolts securing the black cover.

2. Using a plastic trim tool, gently pry the cover to separate it from the EPS gearbox. Slowly work the tool around the bottom edge of the cover to release the cover.

NOTE:

- **Do not** use a screwdriver or metal tool to pry the cover.
- The cover is sealed with an O-ring, which may provide some resistance.

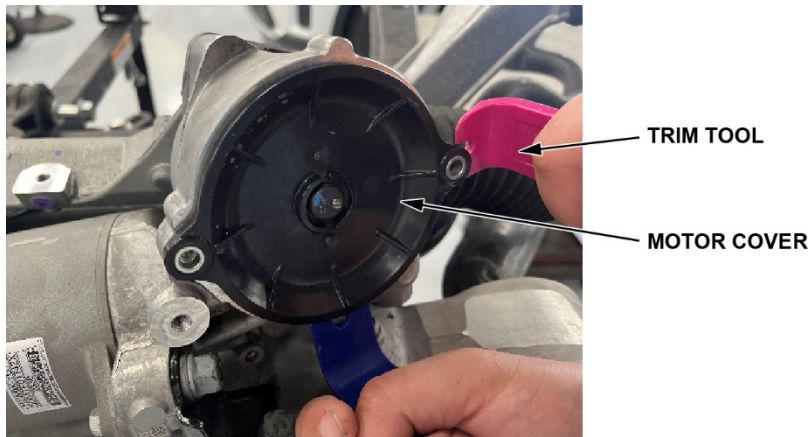

3. Remove the cover.

NOTE: The amount and color of the grease inside the housing may vary from vehicle to vehicle.

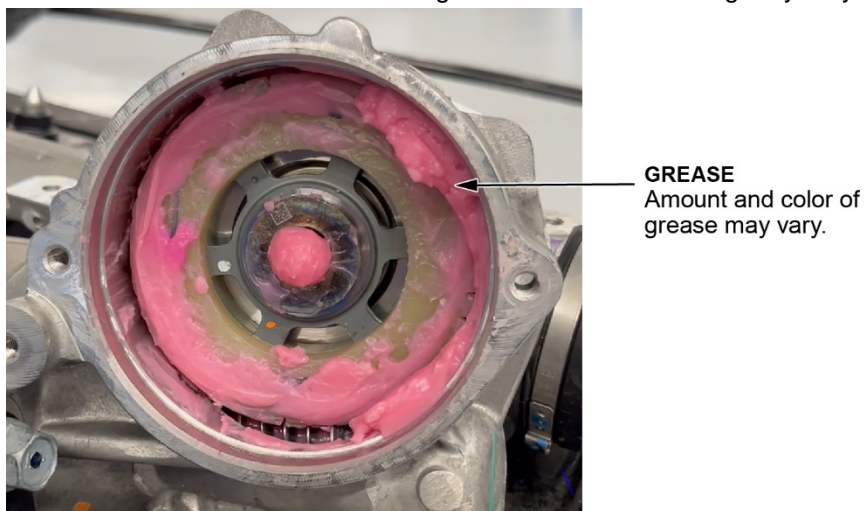

5. Remove the original O-ring from the cover and discard.

6. With a clean cloth, wipe the cover to remove any grease or contamination.

NOTE: **Do not** use brake cleaner to clean the cover.

7. Pack the grease into the worm gear:

NOTE:

- **Do not** add any additional grease.
  - Save a small amount of grease to be used in **Steps 8 and 9**.
1. While wearing clean gloves, start at the top and run your finger along the nylon gear and aluminum housing while directing the excess grease to the metal worm gear at the lower area of the housing.
  2. Once the excess grease is moved to the lower area of the nylon gear, pack the grease into the worm gear location until the grease fills the gap where the worm gear mates with the nylon gear.

Click here to view the video:

[▶ PLAY VIDEO](#)

**BEFORE**



**AFTER**

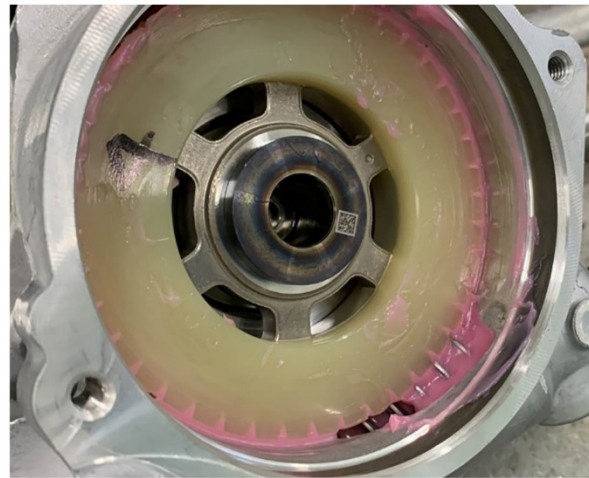

8. **Using the extra grease from the previous step**, apply grease between the new replacement end cap, spring, spring seat, and also on top of the spring seat. Protect the assembly from potential contamination by setting it aside in a safe place.

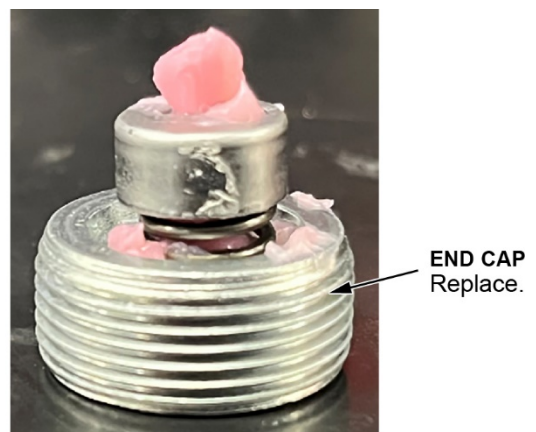
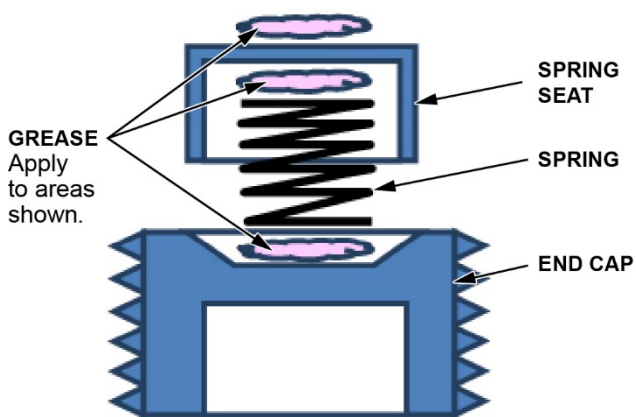

9. Apply grease to the new O-ring.

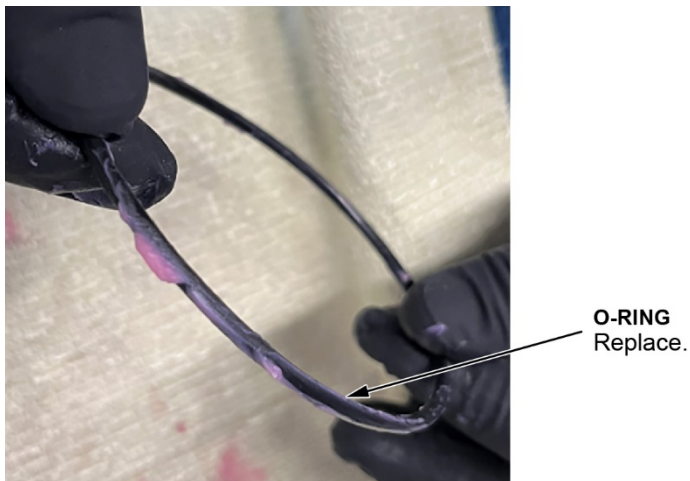

10. Install the new greased O-ring onto the cover.

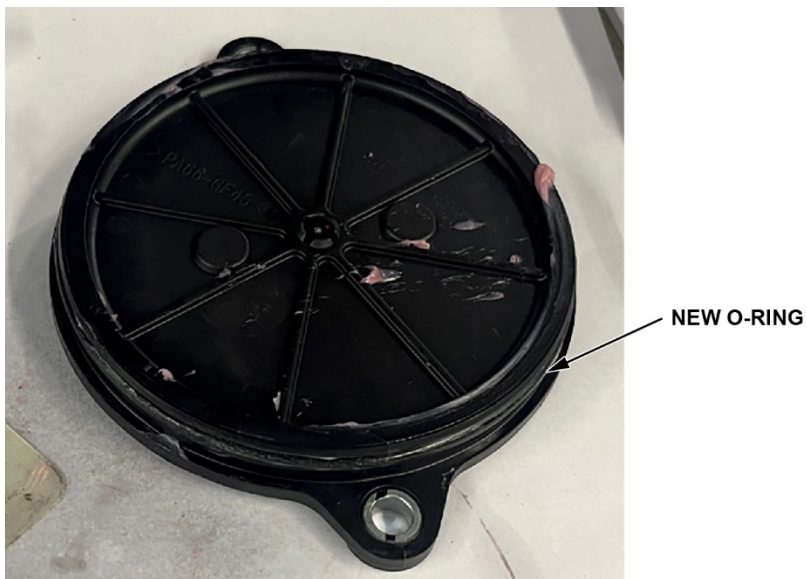

11. Wipe off any excess grease around the EPS aluminum housing.

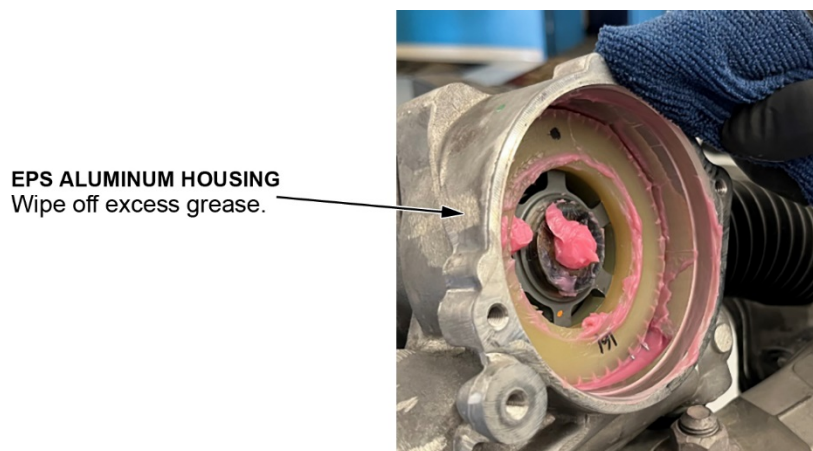



12. Install the steering motor black cover:

1. Loosely install the bolts.
2. Gently press the cover to set the cover onto the aluminum housing.
3. Torque the two bolts to **8 N-m (6 lb-ft)**.



**BOLTS**  
Loosely install.



**COVER**  
Gently press.



**TORQUE BOLTS**  
8 N-m (6 lb-ft)

13. Remove the EPS bracket.



**EPS BRACKET**

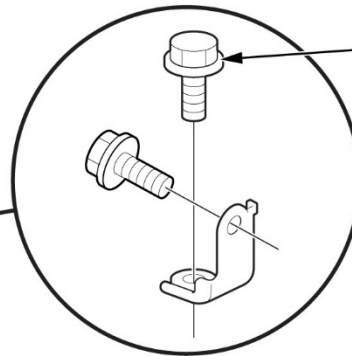

**BOLTS (2)**  
44 N-m (32 lb-ft)

14. Remove the EPS gearbox from the subframe.

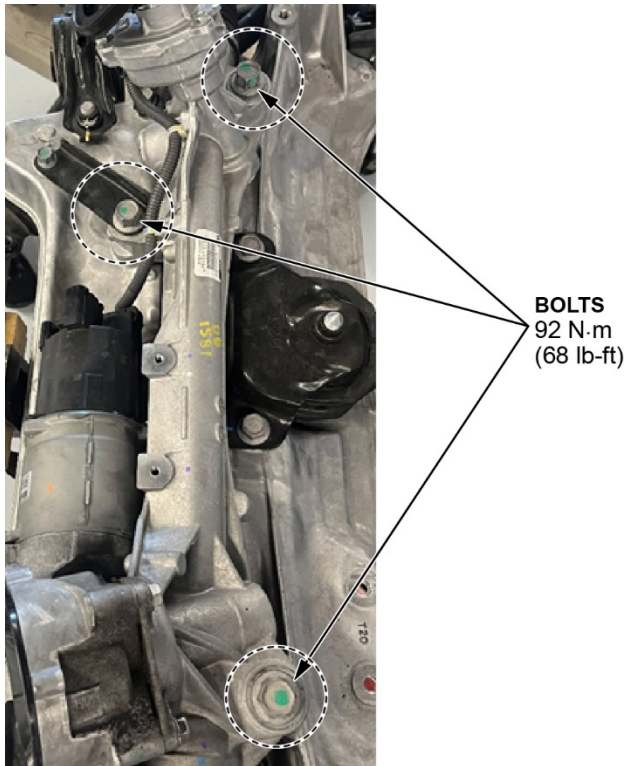

15. Using a wire brush, clean off the exposed sealant around the end cap. Then, use a rag (with brake cleaner) to wipe away any residual loose material.

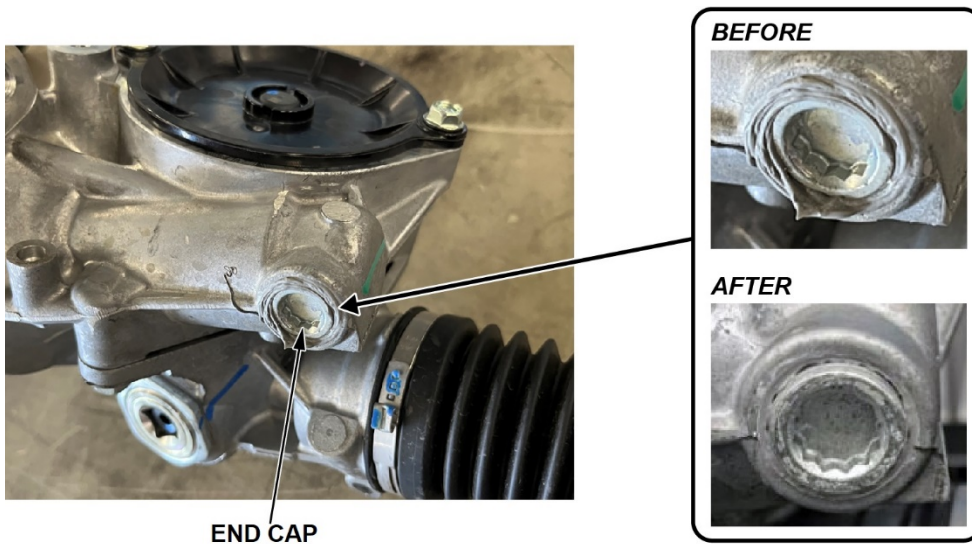

16. With a **10 mm** hex socket bit, remove the end cap on the EPS gearbox.



17. Using a magnet tool, remove the spring from the EPS gearbox and **immediately discard upon removal**.

NOTE: Be careful not to get contamination in the opening.



SPRING  
Discard.

18. Using a magnet tool, remove the spring seat from the EPS gearbox and **immediately discard upon removal**.

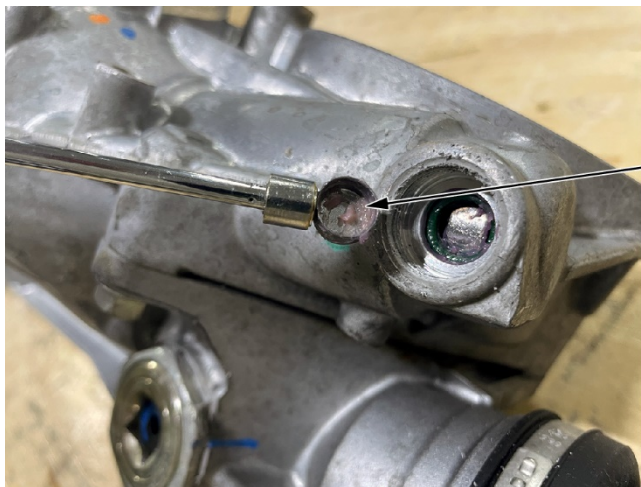

SPRING SEAT  
Discard.



19. With the new spring seat, spring, and end cap held together by the grease, install the pieces together into the EPS gearbox, then tighten the end cap until **4 mm** of threads remain exposed.

NOTE: To keep the parts from falling off the hex socket bit while installing, rotate the EPS housing until the hole is facing downward, then install the spring seat, spring, and end cap up into the hole.

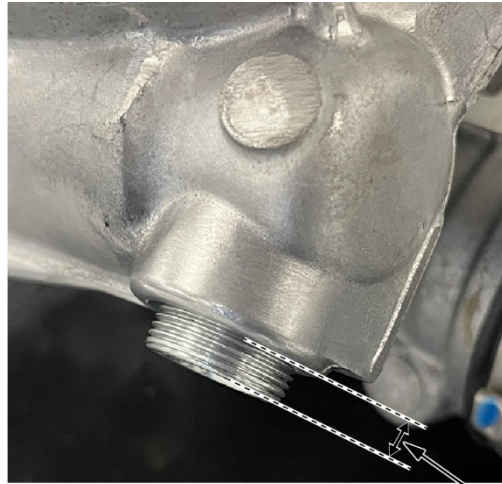

4mm

20. Before torquing, apply Hondabond sealant to the exposed threads of the end cap.

HONDABOND



21. Torque the end cap to **12 N·m (9 lb-ft)**, then remove all excess Hondabond.



END CAP  
12 N·m (9 lb-ft)

22. Install all parts in reverse order of removal.
23. Turn the steering wheel full left then full right to ensure smooth operation.
24. Do a wheel alignment.
25. Do the *VSA Sensor Neutral Position Memorization* [\(Click Here\)](#).