

# Safety Recall

## Code: 931A



<b>Subject</b>	<b>High-Voltage Battery Modules</b>				
<b>Document History</b>	<b>Date</b>		<b>Summary</b>		
	10/21/2025		Updated SVM code and SVM entry instructions.		
	07/15/2025		<b>RECALL REMEDY LAUNCH – Original publication</b> <b>READ ENTIRE CIRCULAR <u>BEFORE</u> DOING ANY WORK</b>		
<b>Affected Vehicles</b>	<b>Country</b>	<b>Beginning Model Year</b>	<b>Ending Model Year</b>	<b>Vehicle</b>	<b>Vehicle Count</b>
	USA	2022	2024	E-TRON GT	4,459
	USA	2022	2024	RS E-TRON GT	1,385
	<i>Check Campaigns/Actions screen in Elsa on the day of repair to verify that a VIN qualifies for repair under this action. Elsa is the <u>only</u> valid campaign inquiry &amp; verification source.</i>				
	<ul style="list-style-type: none"> <li>✓ Campaign status must show “open.”</li> <li>✓ If Elsa shows other open action(s), inform your customer so that the work can also be completed at the same time the vehicle is in the workshop for this campaign.</li> </ul>				
<b>IMPORTANT INFORMATION FOR VEHICLES WITH BOTH 931A AND 931B</b>	<p>A small number of vehicles are assigned both 931A and 931B.</p> <p>If a vehicle has both codes assigned:</p> <ul style="list-style-type: none"> <li>• The 931B inspection must be completed before the software update.</li> <li>• The inspection and potential module replacement will be claimed under the 931B.</li> <li>• The final remedy software will be performed and claimed under the 931A.</li> </ul>				
<b>Problem Description</b>	Certain high-voltage (HV) batteries may experience short circuits within the battery modules. A short circuit in the high-voltage battery module can increase the risk of a fire.				
<b>Corrective Action</b>	Update vehicle software and, if necessary, replace the high-voltage battery modules in affected vehicles.				
<b>Precautions</b>	<b>As a precaution, Audi recommends setting the maximum battery charge to 80%. This is an important measure to help protect the high-voltage battery modules in affected vehicles until the recall remedy is available.</b>				
	The vehicle owner’s manual contains important information about charging the vehicle, and regarding the vehicle’s warning lights and messages. We encourage owners and anyone who drives the vehicle to review the owner’s manual to become familiar with charging procedures, and with the types of vehicle indicators, warnings and messaging they may see.				
<b>Code Visibility</b>	On October 02, 2024 the campaign code was applied to affected vehicles.				
<b>Owner Notification</b>	Recall remedy available owner notification letters will be mailed in July 2025. Owner letter examples are included in this bulletin for your reference.				
<b>Additional Information</b>	<b>Please alert everyone in your dealership about this action, including Sales, Service, Parts and Accounting personnel. Contact Warranty if you have any questions.</b>				
	<b>IMPORTANT REMINDER ON VEHICLES AFFECTED BY SAFETY &amp; COMPLIANCE RECALLS</b>				
	<b>New Vehicles in Dealer Inventory:</b> It is a violation of federal law for a dealer to deliver a new motor vehicle or any new or used item of motor vehicle equipment (including a tire) covered by this notification under a sale or lease until the defect or noncompliance is remedied. By law, dealers must correct, prior to delivery for sale or lease, any vehicle that fails to comply with an applicable Federal Motor Vehicle Safety Standard or that contains a defect relating to				

The information in this document is intended for use only by skilled technicians who have the proper tools, equipment and training to correctly and safely maintain your vehicle. These procedures are not intended to be attempted by "do-it-yourselfers," and you should not assume this document applies to your vehicle, or that your vehicle has the condition described. To determine whether this information applies, contact an authorized Audi dealer. ©2025 Audi of America, Inc. and Audi Canada. All Rights Reserved.

**motor vehicle safety.**

**Pre-Owned Vehicles in Dealer Inventory: Dealers should not deliver any pre-owned vehicles in their inventory which are involved in a safety or compliance recall until the defect has been remedied.**

Dealers must ensure that every affected inventory vehicle has this campaign completed before delivery to consumers.

## Parts Information

**All cars are assigned criteria F8 and SW.**

**Criteria 01-33 is assigned to each VIN to designate which module position(s) require replacement.**

Criteria	Quantity	Part Number	P.O.C. Part Description	Ordering Method
01, 02, 05, 06, 09, 10, 13, 15, 16, 17, 20, 21, 22, 23, 25, 26	1	9J1-915-591-J	BATTERY	Reference POC comments individually by part number.
03, 04, 07, 08, 11, 12, 14, 18, 19, 24, 27, 28, 29, 30, 31, 32, 33	1	9J1-915-592-J	BATTERY	
21, 22	1	9J1-915-153-AA	CONNECTOR	
04, 05, 08, 09, 12, 13, 24, 25	1	9J1-915-153-AB	CONNECTOR	
02, 03, 06, 07, 10, 11, 26, 27	1	9J1-915-153-AC	CONNECTOR	
03, 04, 05, 06, 07, 08, 09, 10, 11, 12, 15, 16, 25, 26, 28, 33	1	9J1-915-153-AD	CONNECTOR	
29, 30, 31, 32	2	9J1-915-153-AD	CONNECTOR	
13, 14	1	9J1-915-153-AE	CONNECTOR	
14, 15, 27	1	9J1-915-153-AG	CONNECTOR	
23, 24	1	9J1-915-153-AH	CONNECTOR	
16, 17, 24	1	9J1-915-153-AJ	CONNECTOR	
01, 02, 22, 23	1	9J1-915-153-AK	CONNECTOR	
ALL	1	9J1-915-153-AM	CONNECTOR	
19, 20	1	9J1-915-153-AN	CONNECTOR	
18, 20	1	9J1-915-153-AP	CONNECTOR	
01-17 and 19-33	1	9J1-915-153-AQ	CONNECTOR	
01-17 and 21-33	1	9J1-915-153-AR	CONNECTOR	
13, 14, 27, 28	1	9J1-915-153-AT	CONNECTOR	
01, 02, 05, 06, 33	1	9J1-915-153-BA	CONNECTOR	
ALL	2	12E-010-001-G	STICKER	
01-17 and 21-33	1	12E-010-006	WARN. SIGN (English)	
01-17 and 21-33	1	12E-010-006-A	WARN. SIGN (French)	
01-17 and 21-33	1	12E-010-006-AA	STICKER	
01-17 and 21-33	1	12E-010-006-Q	WARN. SIGN	
01-17 and 21-33	1	12E-010-849-G	STICKER	
01-17 and 21-33	1	1EA-010-505	WARN. SIGN	
01-17 and 21-33	1	9J1-010-006-B	WARN. SIGN	

**Continued on next page**

Criteria	Quantity	Part Number	P.O.C. Part Description	Ordering Method
ALL	1	9J1-801-407- Y	PLATE	Reference POC comments individually by part number.
01-17 and 21-33	1	9J1-802-423-BY	PLATE	
01-17 and 21-33	10	9J1-804-997-A	SLEEVE	
01-17 and 21-33	6	9J1-915-433-C	GASKET	
01-17 and 21-33	1	9J1-915-433-J	GASKET	
01-17 and 21-33	2	9J1-915-448	DAMP.ELEM	
01-17 and 21-33	2	9J1-915-448-A	DAMP.ELEM	
01-17 and 21-33	4	9J1-915-448-B	DAMP.ELEM	
01-17 and 21-33	1	9J1-971-504-A	BRACKET	
01-17 and 21-33	3	9J1-971-906-B	HOLDER	
01-17 and 21-33	3	D -004-556-M2	2K GLUE	
18-20	1			
01-17 and 21-33	3	D -181-802-M1	ACTIVATOR	
18-20	1			
ALL	Up to 2	D -009-500-25	APPLICATOR (1 per cover)	
01-17 and 21-33	1	D -476-KD1-M3	SEALANT	
18-20	1			
ALL	1/module	D -G00-025-M2	PASTE	
01-17 and 21-33	1	G -055-172-A1	LUBRICANT	
ALL	As needed	G -12E-100-1G CON	G12 EVO Coolant Concentrate	
	<b>-OR-</b>			
	As needed	G -12E-050-1G-RTU	G12 EVO Coolant - 50/50 Pre-mix	
01-17 and 21-33	4	N -909-377-01	TIE WRAP	Reference POC comments individually by part number.
ALL	4/module	N -912-706-01	BOLT	
01-17 and 21-33	186	WHT-009-525-A	SCREW	
18-20	54			
ALL	if necessary	WHT-009-526-A	Screw (repair bolt)	
01-17 and 21-33	11	WHT-009-770	BOLT (9 for SX6, 2 for upper battery housing)	
01-17 and 21-33	6	WHT-009-771	BOLT	
01-17 and 21-33	10	WHT-009-948	NUT	

## Claim Entry Instructions

The labor times listed here may differ from the labor operations and labor times listed in ELSA.

After campaign has been completed, enter claim as soon as possible to help prevent work from being duplicated elsewhere. Attach the Elsa screen print showing action open on the day of repair to the repair order.

If a customer declines campaign work, refer to the “Customer Declines Campaign/Update Repair” section in the Campaign/Update Policy and Procedures Manual.

<b>Service Number</b>	931A
<b>Damage Code</b>	0099
<b>Parts Vendor Code</b>	002
<b>Claim Type</b>	Sold vehicle: 7 10 Unsold vehicle: 7 90
<b>Causal Indicator</b>	Mark BATTERY* as causal part
<b>Vehicle Wash</b>	Do not claim wash under this action
<b>Vehicle Loaner</b>	See special claiming instructions for rental/loaner claiming. <b>NOTE: A 2nd claim must be entered for rental/loaner claiming</b>

### Overview of criteria:

**SW** (assigned to all VINs) – Final remedy software

**Vehicles may also have criteria F8 along with criteria 01 through 33. This indicates pre-identified module(s) that require replacement and will also have to be entered on the claim when module(s) are replaced.**

**F8** – Claimed only if battery module(s) are replaced

**01 through 33** – Module positions 1 through 33

Modules 01-17 and 21-33 are located in the level 1 section (lower/main section) and modules 18-20 are located in the level 2 section (upper section).

**X1, X2, ...X\*** – Assigned for administrative purposes only and is not associated with work needing to be performed. This criteria is not required to be entered on the claim.

<b>Criteria I.D.</b>	<b>SW - Enter when the final software update is completed.</b>		
	Perform final software update		
	<b>Labor Op</b>	<b>Time Units</b>	<b>Description</b>
	0151 00 10	SEE ELSA	Battery charge
	0151 00 60	Time stated on diagnostic protocol	Software update

<b>Criteria I.D.</b>	<b>F8 along with criteria 01 through 33</b>		
	ADD as needed for cell module(s) replacement		

<b>LABOR</b>			
<b>Criteria</b>	<b>Labor Op</b>	<b>Time Units</b>	<b>Description</b>
ALL	0150 00 60	Time stated on diagnostic protocol	GFF/Guided Functions
	1938 17 00	SEE ELSA	Coolant drain+fill
	2706 89 50	SEE ELSA	12V Battery charge
	9301 01 50	SEE ELSA	Battery module check <i>(Classification)</i>
	9301 89 50	SEE ELSA	Battery module charge
	9302 03 50	SEE ELSA	Battery housing measure <i>(Equipotential bonding)</i>
	9303 01 52	SEE ELSA	High voltage battery check <i>(Classification)</i>
	9303 01 54	SEE ELSA	High voltage battery check <i>(Leak test – Level 1 and Level 2)</i>
	9303 01 57	SEE ELSA	High voltage battery check <i>(Initial setup)</i>
	9303 19 50	SEE ELSA	High voltage battery remove+reinstall
	9310 01 50	SEE ELSA	Disable HV system voltage check <i>(Insulation measurement)</i>
	9310 83 50	SEE ELSA	Disable HV system voltage deactivate and activate <i>(Diagnostic activation HV System)</i>
Add only for criteria 01-17 and 21-33	9301 19 50	SEE ELSA	Battery module remove+reinstall <i>(Level 1)</i>
	9302 19 60	SEE ELSA	Battery housing remove+reinstall <i>(Cover – Level 1)</i>
	9303 01 50	SEE ELSA	High voltage battery check <i>(Leak test – Level 1)</i>
	9327 19 50	SEE ELSA	Switch box high-voltage battery remove+reinstall

**Continued on next page**

<b>LABOR (cont.)</b>			
<b>Criteria</b>	<b>Labor Op</b>	<b>Time Units</b>	<b>Description</b>
Add only for criteria 18, 19 or 20	9301 19 52	SEE ELSA	Battery module remove+reinstall (Level 2)
	9302 19 50	SEE ELSA	Battery housing remove+reinstall (Cover – Level 2)
<i>Add the following only if a cell module was classified as critical:</i>			
F8, N1, N2, ...,N*	9301 00 50	SEE ELSA	High-voltage battery module – pack critical high-voltage module
<b>PARTS</b>			
<b>Criteria</b>	<b>Quantity</b>	<b>Part Number</b>	<b>Description</b>
ALL	2	12E010001G	STICKER
ALL	1	9J1801407 Y	PLATE
ALL	1	9J1915153AM	CONNECTOR
ALL	1	D 181802M1	ACTIVATOR
ALL	1/module	D G00025M2	PASTE
ALL	Up to 85.00 or Up to 4.50	G 12E100S1 or G 12E050S0	COOLANT (concentrate) or COOLANT (pre-mix)
ALL	4/module	N 91270601	BOLT
ALL	if necessary	WHT009526A	Screw (repair bolt for covers)
01-17 and 21-33	1	12E010006	WARN. SIGN (English)
01-17 and 21-33	1	12E010006A	WARN. SIGN (French)
01-17 and 21-33	1	12E010006AA	STICKER
01-17 and 21-33	1	12E010006Q	WARN. SIGN
01-17 and 21-33	1	12E010849G	STICKER
01-17 and 21-33	1	1EA010505	WARN. SIGN
01-17 and 21-33	1	9J1010006B	WARN. SIGN
01-17 and 21-33	1	9J1802423BY	PLATE
01-17 and 21-33	10	9J1804997A	SLEEVE
01-17 and 21-33	1	9J1915153AR	CONNECTOR
01-17 and 21-33	6	9J1915433C	GASKET
01-17 and 21-33	1	9J1915433J	GASKET
01-17 and 21-33	2	9J1915448	DAMP.ELEM
01-17 and 21-33	2	9J1915448A	DAMP.ELEM
01-17 and 21-33	4	9J1915448B	DAMP.ELEM
01-17 and 21-33	1	9J1971504A	BRACKET
01-17 and 21-33	3	9J1971906B	HOLDER
01-17 and 21-33	3	D 004556M2	2K GLUE

**Continued on next page**

<b>PARTS (continued)</b>			
<b>Criteria</b>	<b>Quantity</b>	<b>Part Number</b>	<b>Description</b>
01-17 and 21-33	2	D 00950025	APPLICATOR
01-17 and 21-33	1	D 476KD1M3	SEALANT
01-17 and 21-33	1	G 055172A1	LUBRICANT
01-17 and 21-33	4	N 90937701	TIE WRAP
01-17 and 21-33	186	WHT009525A	SCREW
01-17 and 21-33	11	WHT009770	BOLT
01-17 and 21-33	6	WHT009771	BOLT
01-17 and 21-33	10	WHT009948	NUT
21, 22	1	9J1915153AA	CONNECTOR
04, 05, 08, 09, 12, 13, 24, 25	1	9J1915153AB	CONNECTOR
02, 03, 06, 07, 10, 11, 26, 27	1	9J1915153AC	CONNECTOR
03, 04, 05, 06, 07, 08, 09, 10, 11, 12, 15, 16, 25, 26, 28, 33	1	9J1915153AD	CONNECTOR
29, 30, 31, 32	2	9J1915153AD	CONNECTOR
13, 14	1	9J1915153AE	CONNECTOR
14, 15, 27	1	9J1915153AG	CONNECTOR
23, 24	1	9J1915153AH	CONNECTOR
16, 17, 24	1	9J1915153AJ	CONNECTOR
01, 02, 22, 23	1	9J1915153AK	CONNECTOR
19, 20	1	9J1915153AN	CONNECTOR
18, 20	1	9J1915153AP	CONNECTOR
01-17 and 19-33	1	9J1915153AQ	CONNECTOR
13, 14, 27, 28	1	9J1915153AT	CONNECTOR
01, 02, 05, 06, 33	1	9J1915153BA	CONNECTOR
01, 02, 05, 06, 09, 10, 13, 15, 16, 17, 20, 21, 22, 23, 25, 26	1	9J1915591J	BATTERY*
03, 04, 07, 08, 11, 12, 14, 18, 19, 24, 27, 28, 29, 30, 31, 32, 33	1	9J1915592J	BATTERY*
18-20	1	D 004556M2	2K GLUE
18-20	1	D 00950025	APPLICATOR
18-20	1	D 476KD1M3	SEALANT
18-20	54	WHT009525A	SCREW

**Continued on next page**

Vehicle Loaner (if required)	Enter vehicle loaner claim as a separate (2 <sup>nd</sup> ) claim		
	<b>Claim Type</b>	7 MO	(letter O, not number 0)
	<b>Service Number</b>	931A	
	<b>Damage Code</b>	0010	
	<b>Parts Vendor Code</b>	002	
	<b>Criteria</b>	MO	(letter O, not number 0)
	<i>NOTE: Criteria MO must be entered on the vehicle loaner claim.</i>		
	<b>Outside Labor Operation</b>	LOAN1600	Enter dollar amount on rental/loaner invoice: \$50 max per day <b>Two days maximum</b>

## Customer Letter Example (USA) - VEHICLES ASSIGNED ONLY 931A

<MONTH YEAR>

<CUSTOMER NAME>

<CUSTOMER ADDRESS>

<CUSTOMER CITY STATE ZIPCODE>

**This notice applies to your vehicle:** <MODEL YEAR> <BRAND> <CARLINE>, <VIN>

**NHTSA:** 24V726

**Subject: Safety Recall 931A - High-Voltage Battery Modules**

Dear Audi Owner,

This notice is sent to you in accordance with the National Traffic and Motor Vehicle Safety Act. Audi has decided that a defect, which relates to motor vehicle safety, exists in certain 2022-2024 model year Audi vehicles. Our records show that you are the owner of a vehicle affected by this action.

### **What is the issue?**

Certain high-voltage (HV) batteries may experience short circuits within the battery modules. A short circuit in the high-voltage battery module can increase the risk of a fire.

### **What will we do?**

To correct this defect, your authorized Audi dealer will update vehicle software and, if necessary, replace the high-voltage battery modules in affected vehicles. The software update will take about an hour to complete. High-voltage battery module replacement, when necessary, will take up to three (3) days to complete, depending on the number of modules requiring replacement. Both the software update and high-voltage battery module replacement (if necessary) will be performed for you free of charge. Please keep in mind that your dealer may need additional time for the preparation of the work, as well as to accommodate their daily workshop schedule.

### **What should you do?**

Please contact your authorized Audi dealer without delay to schedule this recall work. For your convenience, you can also visit [www.audiusa.com](http://www.audiusa.com) and click on the "Find a Dealer" link to locate a dealer near you and schedule this service.

### **Precautions you should take:**

As a precaution, Audi recommends setting the maximum battery charge to 80%. This is an important measure to help protect the high-voltage battery modules in the vehicle until the recall remedy can be performed.

The vehicle owner's manual contains important information about charging the vehicle, and regarding the vehicle's warning lights and messages. We encourage owners and anyone who drives the vehicle to review the owner's manual to become familiar with charging procedures, and with the types of vehicle indicators, warnings and messaging they may see.

### **Additional Information**

- If you are the lessor and registered owner of the vehicle identified in this action, the law requires you to forward this letter immediately via first-class mail to the lessee within ten (10) days of receipt.
- If your authorized Audi dealer fails or is unable to complete this work free of charge within a reasonable time, if you have changed your address or no longer own the vehicle identified in this letter, or if you should have any questions about this communication, please contact Audi Customer Experience at 1-800-253-2834 or via our "Contact Us" page at [www.audiusa.com](http://www.audiusa.com).
- If you still cannot obtain satisfaction, you may file a complaint with: The Administrator, National Highway Traffic Safety Administration, 1200 New Jersey Avenue, SE., Washington, DC 20590; or call the toll-free Vehicle Safety Hotline at 1-888-327-4236 (TTY:1-888-275-9171); or go to <http://www.safercar.gov>.
- To check your vehicle's eligibility for repair under this or any other recall/service campaign, please visit the Recall/Service Campaign Lookup tool at [www.audiusa.com](http://www.audiusa.com) and enter your Vehicle Identification Number (VIN).
- If you have previously paid for repairs relating to the condition described in this letter, the enclosed form explains how to request reimbursement. We would be pleased to review your reimbursement request.

We apologize for any inconvenience this matter may cause; however, we are taking this action to help ensure your safety and continued satisfaction with your vehicle.

Sincerely,

Audi Customer Protection

## Customer Letter Example (USA) - VEHICLES ASSIGNED BOTH 931A & 931B

<MONTH YEAR>

<CUSTOMER NAME>

<CUSTOMER ADDRESS>

<CUSTOMER CITY STATE ZIPCODE>

**This notice applies to your vehicle:** <MODEL YEAR> <BRAND> <CARLINE>, <VIN>

**NHTSA:** 24V726

**Subject: Safety Recalls 931A & 931B - High-Voltage Battery Modules**

Dear Audi Owner,

This notice is sent to you in accordance with the National Traffic and Motor Vehicle Safety Act. Audi has decided that a defect, which relates to motor vehicle safety, exists in certain 2022-2024 model year Audi vehicles. Our records show that you are the owner of a vehicle affected by this action.

### **What is the issue?**

Certain high-voltage (HV) batteries may experience short circuits within the battery modules. A short circuit in the high-voltage battery module can increase the risk of a fire.

### **What will we do?**

To correct this defect, your authorized Audi dealer will inspect the high-voltage battery modules in affected vehicles, replace module(s) if necessary and perform vehicle software update.

High-voltage battery module inspection, will take up to four (4) days to complete. If the inspection shows that a battery module needs replacement, dealers will order the necessary parts and perform the replacement. This work can take up to three (3) days to complete, depending on the number of modules requiring replacement. The software update will take about an hour to complete.

Both the software update and high-voltage battery module replacement (if necessary) will be performed for you free of charge. Please keep in mind that your dealer may need additional time for the preparation of the work, as well as to accommodate their daily workshop schedule.

### **What should you do?**

Please contact your authorized Audi dealer without delay to schedule this recall work. For your convenience, you can also visit [www.audiusa.com](http://www.audiusa.com) and click on the "Find a Dealer" link to locate a dealer near you and schedule this service.

### **Precautions you should take:**

As a precaution, Audi recommends setting the maximum battery charge to 80%. This is an important measure to help protect the high-voltage battery modules in the vehicle until the recall remedy can be performed.

The vehicle owner's manual contains important information about charging the vehicle, and regarding the vehicle's warning lights and messages. We encourage owners and anyone who drives the vehicle to review the owner's manual to become familiar with charging procedures, and with the types of vehicle indicators, warnings and messaging they may see.

### **Additional Information**

- If you are the lessor and registered owner of the vehicle identified in this action, the law requires you to forward this letter immediately via first-class mail to the lessee within ten (10) days of receipt.
- If your authorized Audi dealer fails or is unable to complete this work free of charge within a reasonable time, if you have changed your address or no longer own the vehicle identified in this letter, or if you should have any questions about this communication, please contact Audi Customer Experience at 1-800-253-2834 or via our "Contact Us" page at [www.audiusa.com](http://www.audiusa.com).
- If you still cannot obtain satisfaction, you may file a complaint with: The Administrator, National Highway Traffic Safety Administration, 1200 New Jersey Avenue, SE., Washington, DC 20590; or call the toll-free Vehicle Safety Hotline at 1-888-327-4236 (TTY:1-888-275-9171); or go to <http://www.safercar.gov>.
- To check your vehicle's eligibility for repair under this or any other recall/service campaign, please visit the Recall/Service Campaign Lookup tool at [www.audiusa.com](http://www.audiusa.com) and enter your Vehicle Identification Number (VIN).
- If you have previously paid for repairs relating to the condition described in this letter, the enclosed form explains how to request reimbursement. We would be pleased to review your reimbursement request.

We apologize for any inconvenience this matter may cause; however, we are taking this action to help ensure your safety and continued satisfaction with your vehicle.

Sincerely,

Audi Customer Protection

## Safety Precautions When Working ON the High-voltage System (additional information is also available in the ELSA Repair Manual)

### DANGER

#### **Extremely dangerous due to high voltage.**

- The high-voltage system is under heavy voltage. Severe bodily injury or death by electrocution or electric arcs is possible.
- When working on the high-voltage system the high-voltage system must be de-energized.
- When performing procedures that do not directly affect the high-voltage system, in some cases it is still necessary to de-energize the high-voltage system.
- Pay attention when the high-voltage system must be de-energized. Refer to the Repair Manual
- Have a High-Voltage Technician or a High-Voltage Expert de-energize the high-voltage system.

#### **The electric and magnetic fields are extremely dangerous.**

- There are electric and magnetic fields on the high-voltage system. Death or serious injury are possible due to malfunction of active implants (for example cardiac pacemakers, insulin pumps).
- Persons with active implants may not perform procedures on the high-voltage system.

### WARNING

#### **Risk of injury - motor may start unexpectedly**

It is difficult to determine whether the drive system of an electric vehicle or hybrid vehicle is active. Moving parts can trap or draw in parts of the body.

### CAUTION

#### **Risk of damage to high-voltage wiring**

- Incorrect handling may result in damage to the insulation of high-voltage wires or high-voltage connectors.
- Do not support yourself on high-voltage cables or connectors.
- Never prop tools against high-voltage wiring or high-voltage connectors.
- Never bend or kink high-voltage wiring.
- Observe the coding of the high-voltage connectors when joining them up.

## Safety Precautions When Working NEAR the High-voltage System (additional information is also available in the ELSA Repair Manual)

### DANGER

#### **Extremely dangerous due to high voltage.**

- The voltage levels in the high-voltage system constitute a safety hazard. Danger of severe or fatal injuries from electric shock if high-voltage components or high-voltage wiring are damaged.
- Carry out a visual check of high-voltage components and high-voltage wiring.
- Never use cutting/forming tools or other sharp-edged implements.
- Never perform work using welding, brazing, thermal bonding or hot air in the area of high-voltage components and high-voltage cables.

 **DANGER**

**High voltage increases the risk of fatal injury**

**Electrocution can cause severe bodily or fatal injury.**

- For the following procedures suitable personal protective equipment must be worn.
- For the following steps two correspondingly qualified technicians must be present for the supervision.
- If necessary, a second technician can help the high-voltage expert outside of the hazardous area within their qualification.
- The personal protective equipment (PPE) must be dry and undamaged.

## Repair Overview

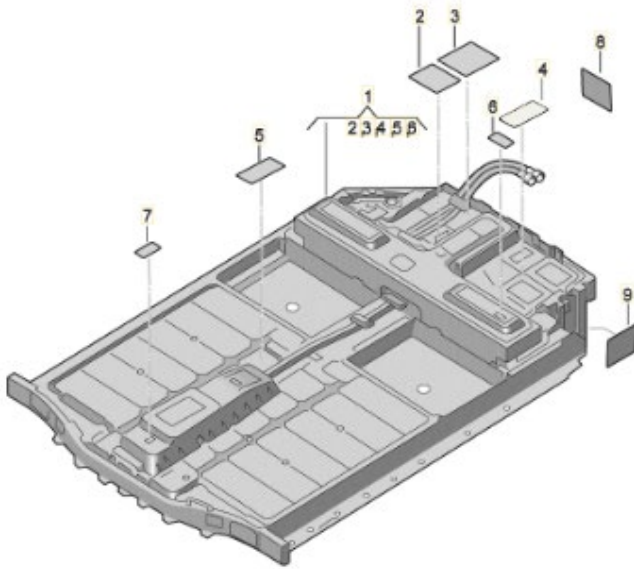

### Vehicles assigned ONLY Criteria SW:

- Perform final remedy software update

### Vehicles assigned Criteria SW AND F8 and 01 thru 33:

- Replace pre-determined cell modules.

X2 is assigned for administrative purposes only and is not associated with work needing to be performed.

## CRITICAL REPAIR STEP

 **STOP!** 

A small number of vehicles are assigned both 931A and 931B.













If a vehicle has both codes assigned:

- The 931B inspection must be completed before the software update.
- The inspection and potential module replacement will be claimed under the 931B.
- The final remedy software will be performed and claimed under the 931A.

## NOTE

- These repair instructions may differ from the labor operations and labor times listed in ELSA.
- Damages resulting from improper repair or failure to follow these work instructions are the dealer's responsibility and are not eligible for reimbursement under this action.
- This procedure must be read in its entirety prior to performing the repair.
- Due to variations in vehicle equipment and options, the steps/illustrations in this work procedure may not identically match all affected vehicles.
- Diagnosis and repair of pre-existing conditions in the vehicle are not covered under this action.
- When working during extreme temperatures, it is recommended that the vehicle be allowed to acclimate inside the shop to avoid temperature-related component damage/breakage.









## Required Tools (if cell module(s) require replacement)



 <p>Battery Tester/Charger capable of <b>minimum 90 Amp</b> continuous supply</p>	 <p>Diagnostic Tester -VAS6150X/6160X- (or equivalent)</p>
 <p>Plates for T40424 -T40424/5-</p>	 <p>Module Picker -T40424-</p>
 <p>Lifting Eye -VAS691013-</p>	 <p>Release Tool -T90027-</p>
 <p>Shock-Proof Protection (30 Pcs) -T40421-</p>	 <p>Digital Scale -VAS231007- (or equivalent)</p>
 <p>Spatula kit -VAS281011- (or equivalent)</p>	 <p>Shop Crane -VAS6100- (or equivalent)</p>
 <p>Double Cartridge Adhesive Gun -VAS5237-</p>	 <p>Pneumatic Gun - 10 Bar -VAS6648KIT-</p>

	<p>Window Cutter -VAG1561B-</p>		<p>Blade Set for VAG1561B -VAG1561A/31-</p>
	<p>Guide Pin (4 Pcs) -T40448-</p>		<p>Test Adapter - Hybrid Module -VAS6558A-</p>
	<p>Plastic Wedge Set -VAS852015-</p>		<p>Double Suction Cups Set - 2Pcs (Similar to VAG1344) -TPK49CUPS-</p>
	<p>Scraper Set -VAS861005- (or equivalent)</p>		<p>Cable Set -VAS6910/12B-</p>
	<p>Connection Line -VAS6910/19-</p>		<p>Module Balancer -VAS6910-</p>
	<p>Support (4 Pcs) -VAS6131/19-</p>		<p>Cooling System Tester for High Voltage Batteries -VAS691005-</p>



	<p>Scissor Lift Table -VAS6131B-</p>		<p>Cartridge Gun -VAG1628- (or equivalent)</p>
	<p>Template -T90023-</p>		<p>High Voltage Tool Set - Voltage Tester -VAS6762/45-</p>
	<p>Adapter Cable -VAS5581/6-</p>		<p>Diagnosis Lead -VAS5581A/12-</p>
	<p>Test Instrument Set -VAS6356-</p>		<p>Vehicle Diagnosis System - Connection Lead -VAS5051/66-</p>
	<p>Pressure Sensor -VAS611013-</p>		<p>Cooling System Tester -VAG1274B-</p>
	<p>Leak Tester - Test Connector Set -VAS6911/3B-</p>		<p>Cooling System Service Machine -VAS531011-</p>

 <p>Digital Pressure Sensor -VAG1397B-</p>	 <p>Spring-Type Clip Pliers -VAS6891- (or equivalent)</p>
 <p>Padlock -T40262/1- (from Service Disconnect Lock -T40262-)</p>	 <p>Frame -T40447-</p>
 <p>Hose Clamps - Up To 25mm -3094- (or equivalent)</p>	 <p>Lifting Tackle -3033-</p>
 <p>Cover -T90028-</p>	 <p>Holding Strap -T40155A- (or equivalent, qty. 2)</p>
 <p>Seal -T40449-</p>	 <p>Shackle (Equivalent to VAS691009A) -VAS691009US- (qty. 2)</p>
 <p>Assembly Tool -T90024B-</p>	 <p>Sealing Plug -T40349-</p>

 <p>Oil Sump Assembly Pin -T40199-</p>	 <p>Depth Gauge -VAS6082- (or equivalent)</p>
 <p>Adapter Cable -VAS5581/1A-2-</p>	 <p>Diagnosis Lead -VAS6558A/39-1-</p>
 <p>Diagnosis Lead -VAS6558A/39-2-</p>	 <p>High Voltage Diagnostics Box -VAS5581A-</p>
 <p>Insulating Mat -VAS6762/44-</p>	 <p>Set of Kelvin Clamps and Test Probes -VAS6558A/27-</p>
 <p>High-voltage tool set -VAS6762A-</p>	 <p>High Voltage Tool Set - Torque Wrench -VAS6883/1A</p>
 <p>Insulated Torx Wrench Set - 3/8 -VAS691003A-</p>	 <p>Warning Sign - "Do Not Insert" -VAS6871-</p>

 <p>Warning Sign - High Voltage -VAS6649-</p>	 <p>Warning Sign - "Do Not Switch On" -VAS6650A-</p>
 <p>Warning Sign – Battery -VAS6786-</p>	

**Required Shop Materials (if necessary)**

  <p>Cleaner D -009-401-04 (shop supply) -OR- 91% Isopropyl Alcohol (locally sourced)</p> <p><b><i>NOTE: Use only 91% Isopropyl alcohol as a cleaner (9% water). Do not use Isopropyl with any additional surfactants (cleaners) or additives (scents).</i></b></p>	 <p>Lint Free Towels (locally sourced)</p>
---	---

## Repair Instruction

### Section A - Check for Previous Repair

#### TIP

If Campaign Completion label is present, no further work is required.

Applicable criteria ID(s)	Campaign/Action Status
01 	Open 

**EXAMPLE**

Campaign/Action	Start	Designation
	2015-11-10	W-SERV_ACT -
	2018-12-13	RECALL -
	2017-05-16	A-RECALL -

**EXAMPLE**

- Enter the VIN in Elsa and proceed to the “Campaign/Action” screen.

#### TIP

On the date of repair, print this screen and keep a copy with the repair order.

- Confirm the Campaign/Action is open <arrow 1>. If the status is closed, no further work is required.
- Note the Applicable Criteria ID <arrow 2> for use in determining the correct work to be done and corresponding parts associated.

#### **CRITICAL REPAIR STEP**



All campaigns/actions with a repair available must be performed in order of the Start date <arrow 3>. The oldest should be performed first (unless otherwise noted in the repair instructions).

#### **Vehicles assigned ONLY Criteria SW:**

- **Proceed to Section C**

#### **Vehicles assigned Criteria SW AND F8 AND 01 through 33:**

- **Proceed to Section B**

## Section B – Replace Cell Module

### **⚠ CRITICAL REPAIR STEP**

**STOP STOP**

Before balancing the new cell module, be sure that the vehicle is ready for the repair to be performed.

If possible, the high voltage battery should be de-energized right after recording the voltage reading to avoid possible voltage variations.

Charging the vehicle, driving the vehicle, leaving the ignition on, or running the HVAC can change the high voltage battery voltage.

After reading out the mean cell module voltage from the MVBs, avoid moving the vehicle if possible. The vehicle must not be charged or have any electrical consumers used. If this step is not followed, there is a risk that the new cell module will not be balanced correctly resulting in possible faults and having to remove and re-balance the cell module again.

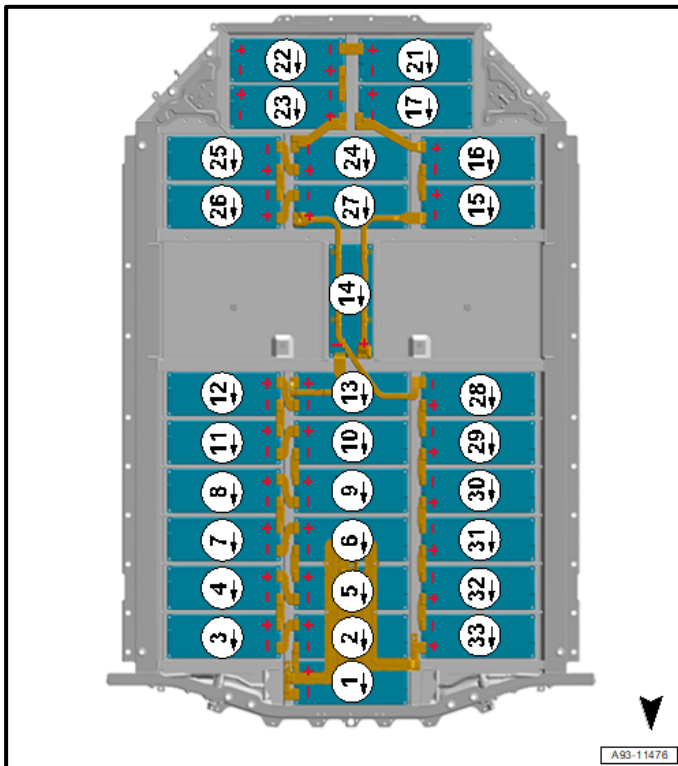

### Cell module replacement determination:

#### **⚠ CRITICAL REPAIR STEP**

**STOP STOP**

#### **Cell module replacement is determined by the assigned criteria!**

The following are examples of an assigned criteria and which cell module requires replacement:

- Criteria SW, F8, 01 requires replacement of cell module #1.
- Criteria SW, F8, 02, 24 requires replacement of cell modules #2 and #24.
- Refer to the corresponding campaign criteria in ELSA to determine which cell module requires replacement.

#### **ⓘ NOTE**

Cell modules 18, 19, 20 are found on level 2. All other cell modules are found on level 1.

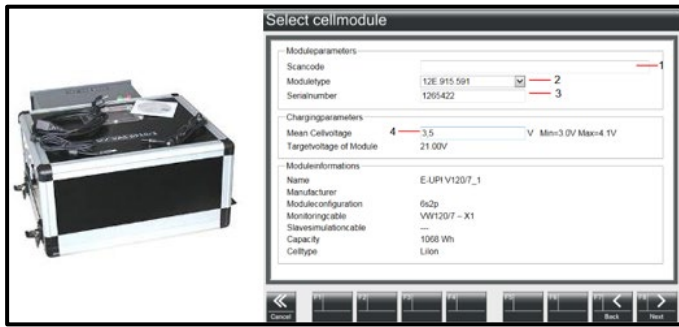

### Balance the new cell module:

- Determine the average cell module voltage per the ELSA repair manual:
  - *Repair manual > Engine > Electric Drive Motor OEG > 93 Electric drive > High-Voltage Battery Unit > Average Cell Voltage, Determining.*
- Balance the new cell module per the ELSA repair manual:
  - *Repair manual > Engine > Electric Drive Motor OEG > 93 Electric drive > High-Voltage Battery Unit > Battery Modules, Charging and Discharging.*
- Follow the VAS6910 operating instructions in conjunction with the DSS Manager program to perform the cell balancing on the new cell module.

**i TIP**

Operating instructions for the VAS6910 and DSS Manager program can be found on the Audi Special Tools and Equipment website.



Image shown may not be actual product.  
Product and price information are subject to change without notice.

Module Balancer  
Model: VAS6910

Price: **\$12,984.18\***

log in for dealer pricing.

Available

Add To Cart

Notes

DSS Manager OperatingManual Rev02  
OperatingManual Rev10  
VAS 6910 Unpacking Instruction and Start-Up EN rev12

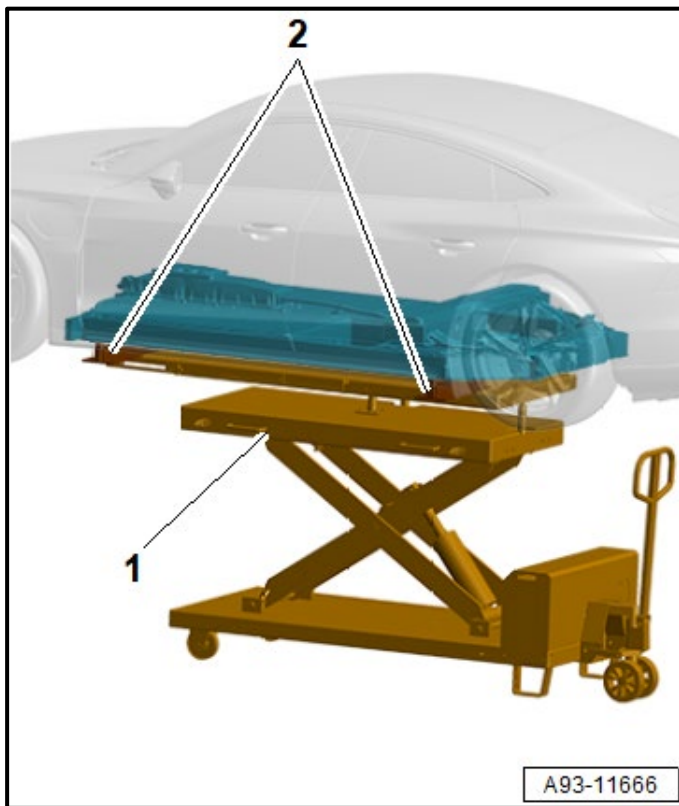

## High-voltage battery removal:

### **⚠ DANGER**

**There is a risk of fatal injury due to high voltage. Electrocutation by direct contact or electric arc can cause severe bodily injury or fatal injury.**

Have a high-voltage technician or a high-voltage expert de-energize the high-voltage system.

- Remove the high-voltage battery from the vehicle per the ELSA repair manual:
  - *Repair manual > Engine > Electric Drive Motor OEG > 93 Electric drive > High-Voltage Battery Unit > High-Voltage Battery 1 AX2, Removing and Installing.*
- Note the following when removing the high-voltage battery:
  - Mark the position of the scissor lift table on the floor to aid in repositioning the table during reinstallation.
  - Pay close attention to all wiring harnesses when lowering the battery.
  - Pay close attention to all coolant hoses when lowering the battery.

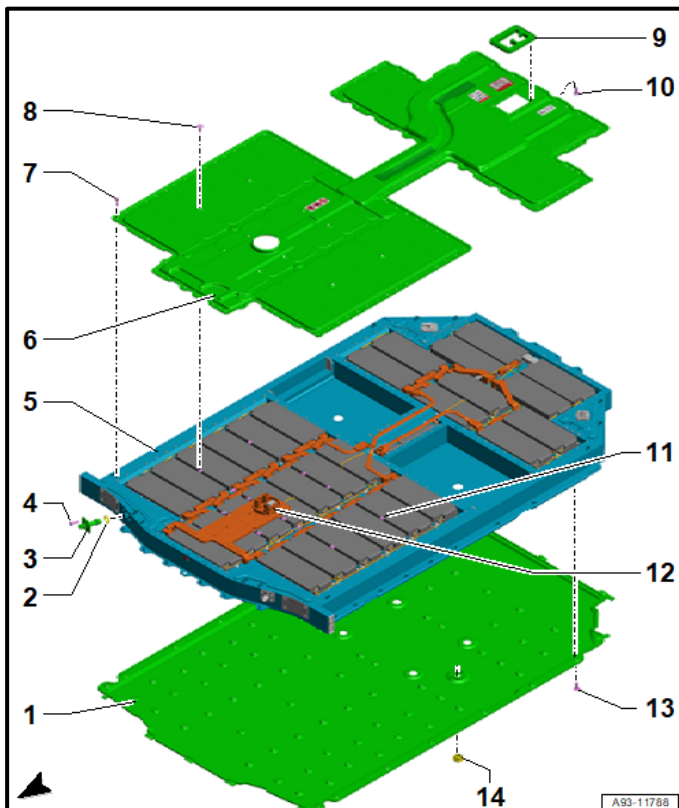

## Remove the high voltage battery cover(s):

### **⚠ DANGER**

**There is a risk of fatal injury due to high voltage. Severe bodily injury or death by electrocution or electric arcs is possible.**

The following procedures may only be performed by a qualified high-voltage expert HVE.

### **⚠ DANGER**

**There is a risk of fatal injury due to high voltage. Electrocution by direct contact or electric arc can cause severe bodily injury or fatal injury.**

- For the following procedures suitable personal protective equipment must be worn.
- For the following steps two correspondingly qualified technicians must be present for the supervision.
- If necessary, a second technician can help the high-voltage expert outside of the hazardous area within their qualification.
- The personal protective equipment (PPE) must be dry and undamaged.

### **⚠ CRITICAL REPAIR STEP**



**RISK OF SEVERE CONSEQUENTIAL DAMAGE!**

**USE HAND TOOLS ONLY!**

Do not use power tools to remove any of the bolts. Using power tools to remove the bolts can damage the threads in the lower housing. Claims for lower housing replacements due to improper bolt removal will be denied.

### **⚠ CAUTION**

**Risk of damaging the high-voltage battery components due to incorrect handling.**

Pay close attention to the ELSA repair manual cautions.

- Clean off any debris that has accumulated on the battery housing prior to opening.

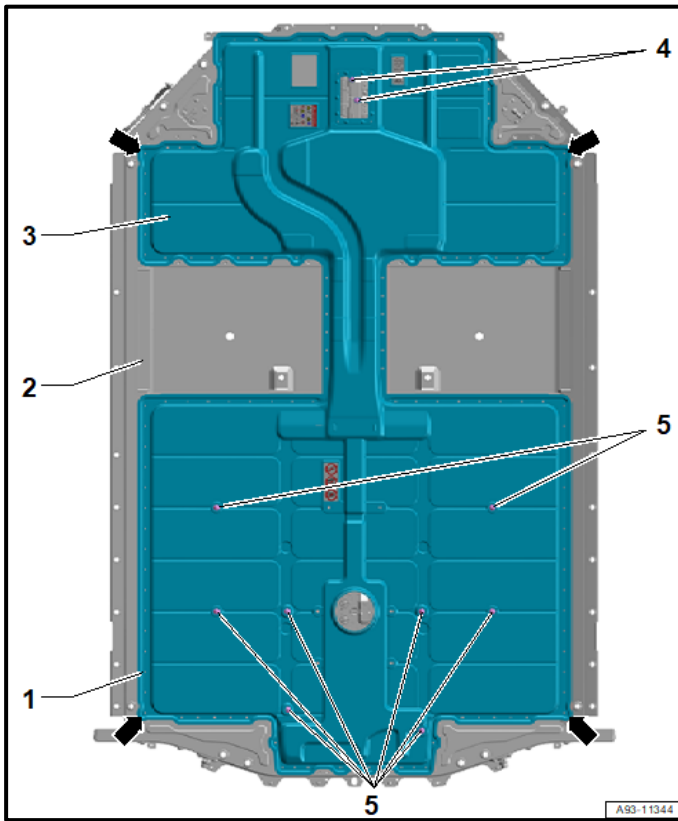

- Refer to the ELSA repair manual for high-voltage battery cover removal:
  - **Layer 1 module replacement:**  
*Repair manual > Engine > 93 Electric drive > High-Voltage Battery Components > Battery Housing Cover, Removing and Installing > Cover for Battery Housing Layer 1, Removing and Installing.*
  - **Layer 2 module replacement:**  
*Repair manual > Engine > 93 Electric drive > High-Voltage Battery Components > Battery Housing Cover, Removing and Installing > Cover for Battery Housing Layer 2, Removing and Installing.*

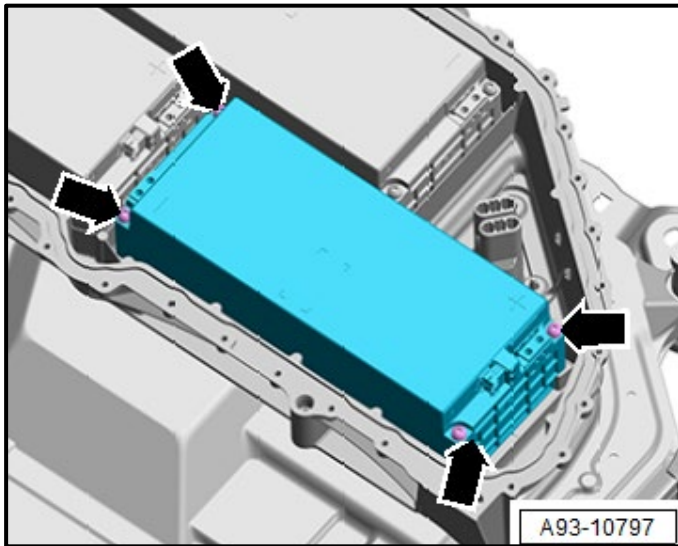

**Replace the affected cell module:**

<p><b>⚠ DANGER</b></p>
<p><b>There is a risk of fatal injury due to high voltage. Severe bodily injury or death by electrocution or electric arcs is possible.</b></p> <p>Pay very close attention to the Repair Manual steps.</p>

- Replace the affected cell module per the ELSA repair manual:
  - **Cell module removal:**  
*Repair manual > Engine > 93 Electric drive > High-Voltage Battery Components > Battery Module, Removing.*
  - **Cell module installation:**  
*Repair manual > Engine > 93 Electric drive > High-Voltage Battery Components > Battery Module, Installing.*

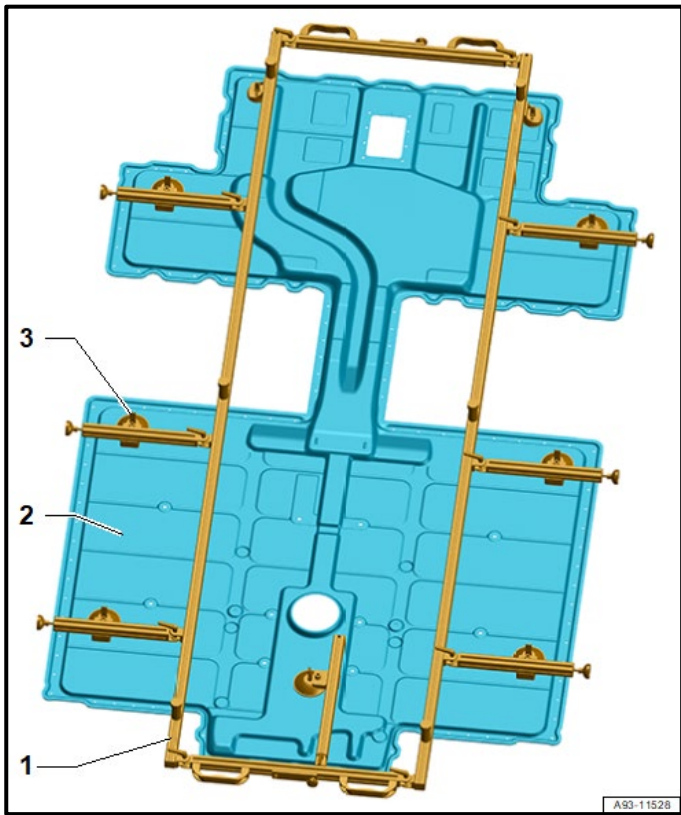

### Install the high-voltage battery cover(s):

- Refer to the ELSA Repair Manual for battery cover installation:
  - **Layer 1 battery cover installation:**  
*Repair manual > Engine > 93 Electric drive > High-Voltage Battery Components > Battery Housing Cover, Removing and Installing > Cover for Battery Housing Layer 1, Removing and Installing.*
  - **Layer 2 battery cover installation:**  
*Repair manual > Engine > 93 Electric drive > High-Voltage Battery Components > Battery Housing Cover, Removing and Installing > Cover for Battery Housing Layer 2, Removing and Installing.*



### NOTE

Referencing the position of the labels on the old battery covers when installing the new battery covers can aid in positioning of the new labels.



## Re-install high-voltage battery:

### **⚠ WARNING**

**There is a risk of fatal injury due to high voltage. Electrocutation by direct contact or electric arc can cause severe bodily injury or fatal injury.**

Have a high-voltage technician or a high-voltage expert bring the high-voltage system back into service.

- Installation is the reverse order of removal.
- Install the high-voltage battery into the vehicle per the ELSA repair manual:
  - *Repair manual > Engine > Electric Drive Motor 0EG > 93 Electric drive > High-Voltage Battery Unit > High-Voltage Battery 1 AX2, Removing and Installing.*



**Classify the removed cell module:**

**⚠ CAUTION**

**There is danger of a health risk due to poisonous vapors, dust, and fluids.**

Never work on high-voltage batteries that have a short circuit.

**⚠ CAUTION**

**There is a risk of burns due to a hot high-voltage battery. It is possible to burn hands.**

Wear safety gloves.

- Classify the removed cell module per the ELSA repair manual:
  - *Repair manual > Engine > 93 Electric drive > High-Voltage Battery Components > Battery Module, Visual Inspection and Classification.*

**Proceed to section C**

## Section C – Final Software Update Instructions

### NOTE

**Prior to launching the VAS Diagnostic Tester and starting an update, ensure the following conditions are met;**

- ✓ **The ODIS software is completely up to date.**
  - Refer to the “Current ODIS Service Version” circular found in Elsa2Go Service References.
- ✓ **The battery charger is connected to the vehicle battery and remains connected for the duration of the software update.**
  - **Battery voltage must remain above 14 volts for the duration of the software update.** Failure to do so may cause the update to fail, which could result in damage to the control module. Control modules damaged by insufficient voltage will not be covered.
- ✓ **The screen saver and power saving settings are off.**
  - Failure to do so may result in the tester entering power save mode during the software update, which could result in damage to the control module.
- ✓ **The VAS Diagnostic Tester is plugged in using the supplied power adapters.**
  - Under no circumstances should the tester be used on battery power alone during the software update. Failure to do so may result in the tester powering off during the update, which could result in damage to the control module.
- ✓ **Flash process through “Audi Flashing” not Guided Fault Finding (GFF).**
  - DO NOT USE Guided Fault Finding (GFF) to perform this flash. Using GFF will cause the flash to take longer. Requests for additional time will not be considered.
- ✓ **The VAS Diagnostics Interface MUST ONLY be connected to the tester with a USB cable.**
  - Performing a software update using a Bluetooth or WiFi connection increases the risk of losing connection during the update, which could result in damage to the control module. It also greatly increases the time required to perform the update. Requests for additional time or parts will be denied if the GFF log shows the update was performed using Bluetooth or WiFi.

### NOTE

- All campaign software updates must be completed during a single, standalone ODIS Diagnostic Session. You must fully complete this campaign and send all logs before beginning any other campaigns or operations.
- If there are any ODIS “Hot-Fix” patches installed, they must be removed from the scan tool before beginning this operation. ODIS “Hot-Fix” patches may affect the update process.

### WARNING

Radiator Fan(s) may cycle ON high speed during the Update Process! There is a serious risk that personal injury may result if contact is made with spinning fan blades. Keep hands and all objects away from Radiator Fan(s) during Update Process!

**! IMPORTANT**

To Update-Programming using SVM, review and follow instructions in Technical Bulletin 2011732: *Software Version Management (SVM) Operating Instructions* for the US, or 2037026: *Working with the Software Version Management (SVM)* for Canada.

The SVM Process must be completed in its entirety so the database receives the update confirmation response. A warranty claim may not be reimbursed if there is no confirmation response to support the claim.

- Switch off all consumers, air conditioning, heater blower motor, lights, heated seats, etc.
- Ensure the latest version of ODIS is downloaded.
- Ensure diagnostic head is connected to ODIS tester via USB cable.
- **Connect battery charger capable of maintaining 100 A and ensure charging voltage is above 14V.**
- Move selector lever to P.
- Open the hood.
- Ensure the hood remains open during the flash.

**! IMPORTANT**

The flash procedure listed below uses a new SVM process for the software update. Please read the instructions below prior to starting the flash.

- Use operating mode, FLASH.
- Select **“SVM – Authorized Multiple Code Entry”**.
- **Do not use “SVM – Code Input”**.

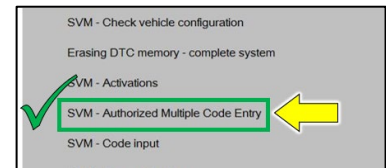

- For the new software update program, the following SVM code must be entered exactly, including commas and without spaces (recommendation: scan QR code with hand-held scanner or copy and paste the SVM code chain).

**DUCHVAPKOFF, DUCFSPCLR008C, 93SWA799, DUCHVAPKON**



- When exiting the FLASH program, ensure the diagnostic log is sent to GFF Paperless.

**Proceed to Section D**

**! IMPORTANT**

If the software update fails for any reason, ODIS feedback must be sent prior to further diagnosis. This ensures the failure/error is reported. Failure to do so may result in non-payment of consequential requests for additional time or parts.

## Section D – Campaign Completion Label

I certify that this campaign  
has been performed in strict  
accordance with the applicable  
Audi repair procedure.

SAGA Code: \_\_\_\_\_

Technician: \_\_\_\_\_

Date: \_\_\_\_\_

Item#: AUD4927ENG

### Install Campaign Completion Label

- Fill out and affix Campaign Completion Label, part number CAMP 010 000, next to the vehicle emission control information label.



Ensure Campaign Completion Label does not cover any existing label(s).

**Proceed to Section E**

## Section E - Parts Return/Disposal

### High-Voltage Battery Module(s):

Refer to the latest instructions for high-voltage battery recycling, found in Elsa2Go: *Elsa2Go-> Infomedia->Service References->Electric Vehicle Category ->“HV Battery Recycling Program Guide”*

### All other parts:

Properly store (retain), destroy or dispose of removed parts in accordance with all state/province and local requirements, unless otherwise indicated and/or requested through the Warranty Parts Portal (WPP).