



Audi

Safety Recall

Code: 931B

Subject High-Voltage Battery Modules

Document History

Date	Summary
11/08/2024	Original publication

Affected Vehicles

Country	Beginning Model Year	Ending Model Year	Vehicle	Vehicle Count
USA	2022	2024	E-TRON GT	568
USA	2022	2024	RS E-TRON GT	152
CAN	2022	2024	E-TRON GT	495
CAN	2022	2023	RS E-TRON GT	207

Check Campaigns/Actions screen in Elsa on the day of repair to verify that a VIN qualifies for repair under this action. Elsa is the only valid campaign inquiry & verification source.

- ✓ Campaign status must show "open."
- ✓ If Elsa shows other open action(s), inform your customer so that the work can also be completed at the same time the vehicle is in the workshop for this campaign.

Problem Description

Certain high-voltage (HV) batteries may experience short circuits within the battery modules. A short circuit in the high-voltage battery module can increase the risk of a fire.

Interim High-voltage Battery Module Inspection

To help monitor high-voltage battery modules until the recall remedy becomes available, dealers will inspect the high-voltage battery modules in affected vehicles. This is not the final recall remedy.

The monitoring program should be carried on inventory vehicles. However, inventory vehicles cannot be delivered until the final recall remedy is available.

Precautions

As a precaution, Audi recommends setting the maximum battery charge to 80%. This is an important measure to help protect the high-voltage battery modules in affected vehicles until the recall remedy is available.

The vehicle owner's manual contains important information about charging the vehicle, and regarding the vehicle's warning lights and messages. We encourage owners and anyone who drives the vehicle to review the owner's manual to become familiar with charging procedures, and with the types of vehicle indicators, warnings and messaging they may see.

Code Visibility

On October 02, 2024, the campaign code was applied to affected vehicles.

Interim Owner Notification

Interim owner notification will take place in November 2024. Interim owner letter examples are included in this bulletin for your reference.

Additional Information

Please alert everyone in your dealership about this action, including Sales, Service, Parts and Accounting personnel. Contact Warranty if you have any questions.

IMPORTANT REMINDER ON VEHICLES AFFECTED BY SAFETY & COMPLIANCE RECALLS

New Vehicles in Dealer Inventory: It is a violation of federal law for a dealer to deliver a new motor vehicle or any new or used item of motor vehicle equipment (including a tire) covered by this notification under a sale or lease until the defect or noncompliance is remedied. By law, dealers must correct, prior to delivery for sale or lease, any vehicle that fails to comply

with an applicable Federal Motor Vehicle Safety Standard or that contains a defect relating to motor vehicle safety.

Pre-Owned Vehicles in Dealer Inventory: Dealers should not deliver any pre-owned vehicles in their inventory which are involved in a safety or compliance recall until the defect has been remedied.

Dealers must ensure that every affected inventory vehicle has this campaign completed before delivery to consumers.

Parts Information (if required)

Module Position	Quantity	Part Number	P.O.C. Part Description	Ordering Method
01, 02, 05, 06, 09, 10, 13, 15, 16, 17, 20, 21, 22, 23, 25, 26	1	9J1-915-591-J	BATTERY	Reference POC comments individually by part number.
03, 04, 07, 08, 11, 12, 14, 18, 19, 24, 27, 28, 29, 30, 31, 32, 33	1	9J1-915-592-J	BATTERY	
21, 22	1	9J1-915-153-AA	CONNECTOR	
04, 05, 08, 09, 12, 13, 24, 25	1	9J1-915-153-AB	CONNECTOR	
02, 03, 06, 07, 10, 11, 26, 27	1	9J1-915-153-AC	CONNECTOR	
03, 04, 05, 06, 07, 08, 09, 10, 11, 12, 15, 16, 25, 26, 28, 33	1	9J1-915-153-AD	CONNECTOR	
29, 30, 31, 32	2	9J1-915-153-AD	CONNECTOR	
13, 14	1	9J1-915-153-AE	CONNECTOR	
14, 15, 27	1	9J1-915-153-AG	CONNECTOR	
23, 24	1	9J1-915-153-AH	CONNECTOR	
16, 17, 24	1	9J1-915-153-AJ	CONNECTOR	
01, 02, 22, 23	1	9J1-915-153-AK	CONNECTOR	
ALL	1	9J1-915-153-AM	CONNECTOR	
19, 20	1	9J1-915-153-AN	CONNECTOR	
18, 20	1	9J1-915-153-AP	CONNECTOR	
01-17 and 19-33	1	9J1-915-153-AQ	CONNECTOR	
01-17 and 21-33	1	9J1-915-153-AR	CONNECTOR	
13, 14, 27, 28	1	9J1-915-153-AT	CONNECTOR	
01, 02, 05, 06, 33	1	9J1-915-153-BA	CONNECTOR	
ALL	2	12E-010-001-G	STICKER	
01-17 and 21-33	1	12E-010-006	WARN. SIGN (English)	
01-17 and 21-33	1	12E-010-006-A	WARN. SIGN (French)	
01-17 and 21-33	1	12E-010-006-AA	STICKER	
01-17 and 21-33	1	12E-010-006-Q	WARN. SIGN	
01-17 and 21-33	1	12E-010-849-G	STICKER	
01-17 and 21-33	1	1EA-010-505	WARN. SIGN	
01-17 and 21-33	1	9J1-010-006-B	WARN. SIGN	

Continued on next page

Module Position	Quantity	Part Number	P.O.C. Part Description	Ordering Method
ALL	1	9J1-801-407- Y	PLATE	Reference POC comments individually by part number.
01-17 and 21-33	1	9J1-802-423-BY	PLATE	
01-17 and 21-33	10	9J1-804-997-A	SLEEVE	
01-17 and 21-33	6	9J1-915-433-C	GASKET	
01-17 and 21-33	1	9J1-915-433-J	GASKET	
01-17 and 21-33	2	9J1-915-448	DAMP.ELEM	
01-17 and 21-33	2	9J1-915-448-A	DAMP.ELEM	
01-17 and 21-33	4	9J1-915-448-B	DAMP.ELEM	
01-17 and 21-33	1	9J1-971-504-A	BRACKET	
01-17 and 21-33	3	9J1-971-906-B	HOLDER	
01-17 and 21-33	3	D -004-556-M2	2K GLUE	
18-20	1			
01-17 and 21-33	3	D -181-802-M1	ACTIVATOR	
18-20	1			
ALL	Up to 2	D -009-500-25	APPLICATOR (1 per cover)	
01-17 and 21-33	1	D -476-KD1-M3	SEALANT	
18-20	1			
ALL	1/module	D -G00-025-M2	PASTE	
01-17 and 21-33	1	G -055-172-A1	LUBRICANT	
ALL	As needed	G -12E-100-1G CON	G12 EVO Coolant Concentrate	
	-OR-			
	As needed	G -12E-050-1G-RTU	G12 EVO Coolant - 50/50 Pre-mix	
01-17 and 21-33	4	N -909-377-01	TIE WRAP	Reference POC comments individually by part number.
ALL	4/module	N -912-706-01	BOLT	
01-17 and 21-33	186	WHT-009-525-A	SCREW	
18-20	54			
ALL	if necessary	WHT-009-526-A	Screw (repair bolt)	
01-17 and 21-33	11	WHT-009-770	BOLT (9 for SX6, 2 for upper battery housing)	
01-17 and 21-33	6	WHT-009-771	BOLT	
01-17 and 21-33	10	WHT-009-948	NUT	

The information in this document is intended for use only by skilled technicians who have the proper tools, equipment and training to correctly and safely maintain your vehicle. These procedures are not intended to be attempted by "do-it-yourselfers," and you should not assume this document applies to your vehicle, or that your vehicle has the condition described. To determine whether this information applies, contact an authorized Audi dealer. ©2024 Audi of America, Inc. and Audi Canada. All Rights Reserved.

Claim Entry Instructions

The labor times listed here may differ from the labor operations and labor times listed in ELSA.

After campaign has been completed, enter claim as soon as possible to help prevent work from being duplicated elsewhere. Attach the Elsa screen print showing action open on the day of repair to the repair order.

If a customer declines campaign work, refer to the “Customer Declines Campaign/Update Repair” section in the Campaign/Update Policy and Procedures Manual.

Service Number	931B
Damage Code	0099
Parts Vendor Code	002
Claim Type	Sold vehicle: 7 10 Unsold vehicle: 7 90
Causal Indicator	Mark labor as causal if HV battery is OK Mark BATTERY* as causal if a module requires replacement
Vehicle Wash	Do not claim wash under this action
Vehicle Loaner	See special claiming instructions for rental/loaner claiming. NOTE: A 2nd claim must be entered for rental/loaner claiming

Overview of criteria:

SW (assigned to all VINs) – Claimed only when the software update is completed (**not yet available**)

IMPORTANT: the software update is not available at this time. Criteria SW can only be claimed once the software update is available. DO NOT enter criteria SW during the monitoring period. Claiming SW will close the campaign.

Vehicles will also have criteria F8 or N1, N2, ...,N* assigned. These criteria will be entered on the claim when the vehicle comes in for an inspection. These also differentiate which type of inspection is needed.

F8 – No previous inspection performed.

N1, N2, ...,N*. – Vehicle had already been to the dealer for an inspection under the 93VN or has previously been to the dealer for an inspection under the 931B.

Before the final software remedy is available, inspection and module replacement claims must be entered correctly. Failure to do so will cause issues for future claims.

Criteria I.D.	SW – CANNOT BE CLAIMED!
----------------------	--------------------------------

Criteria I.D.	F8		
	Perform HV battery module analysis and no module required replacement.		
	LABOR		
	Labor Op	Time Units	Description
	0183 00 99	120	Perform HV battery module analysis and no module required replacement.

Criteria I.D.	N1, N2, ...,N*		
	Perform HV battery module analysis and no module required replacement.		
	LABOR		
	Labor Op	Time Units	Description
	0183 00 99	40	Perform HV battery module analysis and no module required replacement.

Continued on next page

The repair information in this document is intended for use only by skilled technicians who have the proper tools, equipment and training to correctly and safely maintain your vehicle. These procedures are not intended to be attempted by "do-it-yourselfers," and you should not assume this document applies to your vehicle, or that your vehicle has the condition described. To determine whether this information applies, contact an authorized Audi dealer. ©2024 Audi of America, Inc. and Audi Canada. All Rights Reserved.

Claim the following, as needed, if cell module(s) required replacement			
LABOR			
Criteria	Labor Op	Time Units	Description
F8	9303 01 99	120	Perform HV battery module analysis
N1, N2, ...,N*	9303 02 99	40	Perform HV battery module analysis
F8, N1, N2, ...,N*	0150 00 10	SEE ELSA	GFF/Guided Functions (<i>setup + battery charger</i>)
	0150 00 60	Time stated on diagnostic protocol	GFF/Guided Functions (<i>GFF operations</i>)
	1938 17 00	SEE ELSA	Coolant drain+fill
	9301 01 50	SEE ELSA	Battery module check (<i>Classification</i>)
	9301 89 50	SEE ELSA	Battery module charge (<i>claim for each battery module charged</i>)
	9302 03 50	SEE ELSA	Battery housing measure (<i>Equipotential bonding</i>)
	9303 01 52	SEE ELSA	High voltage battery check (<i>Classification</i>)
	9303 01 54	SEE ELSA	High voltage battery check (<i>Leak test – Level 1 and Level 2</i>)
	9303 01 57	SEE ELSA	High voltage battery check (<i>Initial setup</i>)
	9303 19 50	SEE ELSA	High voltage battery remove+reinstall
	9310 01 50	SEE ELSA	Disable HV system voltage check (<i>Insulation measurement</i>)
	9310 83 50	SEE ELSA	Disable HV system voltage deactivate and activate (<i>Diagnostic activation HV System</i>)
Add only for modules 01-17 and 21-33	9301 19 50	SEE ELSA	Battery module remove+reinstall (<i>Level 1</i>)
	9302 19 60	SEE ELSA	Battery housing remove+reinstall (<i>Cover – Level 1</i>)
	9303 01 50	SEE ELSA	High voltage battery check (<i>Leak test – Level 1</i>)
	9327 19 50	SEE ELSA	Switch box high-voltage battery remove+reinstall
Add only for modules 18, 19 or 20	9301 19 52	SEE ELSA	Battery module remove+reinstall (<i>Level 2</i>)
	9302 19 50	SEE ELSA	Battery housing remove+reinstall (<i>Cover – Level 2</i>)
<i>Add the following only if a cell module was classified as critical:</i>			
F8, N1, N2, ...,N*	9301 00 50	SEE ELSA	High-voltage battery module – pack critical high-voltage module

Continued on next page

PARTS			
Module Position	Quantity	Part Number	Description
ALL	2	12E010001G	STICKER
ALL	1	9J1801407 Y	PLATE
ALL	1	9J1915153AM	CONNECTOR
ALL	1	D 181802M1	ACTIVATOR
ALL	1/module	D G00025M2	PASTE
ALL	Up to 85.00 or Up to 4.50	G 12E100S1 or G 12E050S0	COOLANT (concentrate) or COOLANT (pre-mix)
ALL	4/module	N 91270601	BOLT
ALL	if necessary	WHT009526A	Screw <i>(repair bolt for covers)</i>
01-17 and 21-33	1	12E010006	WARN. SIGN (English)
01-17 and 21-33	1	12E010006A	WARN. SIGN (French)
01-17 and 21-33	1	12E010006AA	STICKER
01-17 and 21-33	1	12E010006Q	WARN. SIGN
01-17 and 21-33	1	12E010849G	STICKER
01-17 and 21-33	1	1EA010505	WARN. SIGN
01-17 and 21-33	1	9J1010006B	WARN. SIGN
01-17 and 21-33	1	9J1802423BY	PLATE
01-17 and 21-33	10	9J1804997A	SLEEVE
01-17 and 21-33	1	9J1915153AR	CONNECTOR
01-17 and 21-33	6	9J1915433C	GASKET
01-17 and 21-33	1	9J1915433J	GASKET
01-17 and 21-33	2	9J1915448	DAMP.ELEM
01-17 and 21-33	2	9J1915448A	DAMP.ELEM
01-17 and 21-33	4	9J1915448B	DAMP.ELEM
01-17 and 21-33	1	9J1971504A	BRACKET
01-17 and 21-33	3	9J1971906B	HOLDER
01-17 and 21-33	3	D 004556M2	2K GLUE
01-17 and 21-33	2	D 00950025	APPLICATOR
01-17 and 21-33	1	D 476KD1M3	SEALANT
01-17 and 21-33	1	G 055172A1	LUBRICANT
01-17 and 21-33	4	N 90937701	TIE WRAP
01-17 and 21-33	186	WHT009525A	SCREW
01-17 and 21-33	11	WHT009770	BOLT
01-17 and 21-33	6	WHT009771	BOLT
01-17 and 21-33	10	WHT009948	NUT

Continued on next page

PARTS (continued)			
Module Position	Quantity	Part Number	Description
21, 22	1	9J1915153AA	CONNECTOR
04, 05, 08, 09, 12, 13, 24, 25	1	9J1915153AB	CONNECTOR
02, 03, 06, 07, 10, 11, 26, 27	1	9J1915153AC	CONNECTOR
03, 04, 05, 06, 07, 08, 09, 10, 11, 12, 15, 16, 25, 26, 28, 33	1	9J1915153AD	CONNECTOR
29, 30, 31, 32	2	9J1915153AD	CONNECTOR
13, 14	1	9J1915153AE	CONNECTOR
14, 15, 27	1	9J1915153AG	CONNECTOR
23, 24	1	9J1915153AH	CONNECTOR
16, 17, 24	1	9J1915153AJ	CONNECTOR
01, 02, 22, 23	1	9J1915153AK	CONNECTOR
19, 20	1	9J1915153AN	CONNECTOR
18, 20	1	9J1915153AP	CONNECTOR
01-17 and 19-33	1	9J1915153AQ	CONNECTOR
13, 14, 27, 28	1	9J1915153AT	CONNECTOR
01, 02, 05, 06, 33	1	9J1915153BA	CONNECTOR
01, 02, 05, 06, 09, 10, 13, 15, 16, 17, 20, 21, 22, 23, 25, 26	1	9J1915591J	BATTERY*
03, 04, 07, 08, 11, 12, 14, 18, 19, 24, 27, 28, 29, 30, 31, 32, 33	1	9J1915592J	BATTERY*
18-20	1	D 004556M2	2K GLUE
18-20	1	D 00950025	APPLICATOR
18-20	1	D 476KD1M3	SEALANT
18-20	54	WHT009525A	SCREW

Continued on next page

Vehicle Loaner (if required)	Enter vehicle loaner claim as a separate (2nd) claim		
	Claim Type	7 MO	(letter O, not number 0)
	Service Number	931B	
	Damage Code	0010	
	Parts Vendor Code	002	
	Criteria	MO	(letter O, not number 0)
	<i>NOTE: Criteria MO must be entered on the vehicle loaner claim.</i>		
	Outside Labor Operation	LOAN1600	Enter dollar amount on rental/loaner invoice: US Dealers - \$50 max per day Canadian Dealers - \$60 max per day

	See below for the number of days allowed for waiting for evaluation results and, if required, module replacement.		
	Assigned Criteria	Module Replacement	Max number of days allowed
	F8	NO	4
		YES	6
	N1, N2, ...,N*	NO	1
YES		3	

Customer Letter Example (USA) / INTERIM INSPECTION

<MONTH YEAR>

This notice applies to your vehicle: <VIN>

<MODEL YEAR> <BRAND> <MODEL>

NHTSA: 24V726

Audi Recall: 931B – High-Voltage Battery Modules

INTERIM SAFETY RECALL NOTICE

FREE HIGH-VOLTAGE BATTERY MODULE INSPECTION

This notice is sent to you in accordance with the *National Traffic and Motor Vehicle Safety Act*. Audi has decided that a defect, which relates to motor vehicle safety, exists in certain 2022-2024 model year Audi vehicles. Our records show that you are the owner of a vehicle affected by this action.

About this Recall: Certain high-voltage (HV) batteries may experience short circuits within the battery modules. A short circuit in the high-voltage battery module can increase the risk of a fire.

A recall remedy is not yet available. Audi is working to make a remedy available as quickly as possible and expects the remedy to be available by the end of the 1st quarter of 2025. The recall remedy, when available, will be FREE of charge. We will send you a letter when your dealer has instructions ready to complete it for you.

In the interim, Audi has a FREE high-voltage battery module inspection program for your vehicle ready now. This is not a recall remedy, but an interim step to help monitor your vehicle's high-voltage battery modules until the recall remedy becomes available. Your authorized Audi dealer will inspect the high-voltage battery modules in your vehicle, FREE of charge. This work will take up to four (4) days to complete.

- If the inspection shows all battery modules operating normally, your dealer will schedule a follow-up inspection appointment after 90 days.
- If the inspection shows that a battery module needs replacement, your dealer will order the necessary parts and perform the replacement for you FREE of charge. This work can take up to three (3) days to complete, depending on the number of modules requiring replacement.
- Please contact your authorized Audi dealer to schedule your first FREE high-voltage battery module inspection appointment without delay. For your convenience, you can also visit www.audiusa.com and click on the "Find a Dealer" link to locate a dealer near you to schedule.

Precautions you should take: Audi recommends setting the maximum battery charge to 80%. This is an important measure to help protect the high-voltage battery modules in your vehicle until the recall remedy is available.

As always, should you have concerns about your vehicle, please make an appointment with your authorized Audi dealer to have the vehicle concern diagnosed.

Your vehicle owner's manual contains important information about charging your vehicle, and regarding your vehicle's warning lights and messages. We encourage you and anyone who drives your vehicle to review the owner's manual to become familiar with charging procedures, and with the types of vehicle indicators, warnings and messaging you may see.

Your safety and that of your passengers is our highest priority. We apologize for any inconvenience this letter may cause.

Sincerely,

Audi Customer Protection



Audi

Audi of America, Inc., 3800 Hamlin Road, Auburn Hills, MI 48326

If you should have any questions about this communication, please contact Audi Customer Experience at 1-800-253-2834 or via our "Contact Us" page at www.audiusa.com. If you still cannot obtain satisfaction, you may file a complaint with: The Administrator, National Highway Traffic Safety Administration, 1200 New Jersey Avenue, SE., Washington, DC 20590; or call the toll-free Vehicle Safety Hotline at 1-888-327-4236 (TTY: 1-800-424-9153); or go to <http://www.safercar.gov>.

To check your vehicle's eligibility for repair under this or any other recall/service campaign, please visit the Recall/Service Campaign Lookup tool at www.audiusa.com and enter your Vehicle Identification Number (VIN).

If you are the lessor and registered owner of the vehicle identified in this action, the law requires you to forward this letter immediately via first-class mail to the lessee within ten (10) days of receipt. If you have changed your address or no longer own the vehicle identified in this letter, please let us know so we can update our records.

Customer Letter Example (Canada) / INTERIM INSPECTION

<MONTH YEAR>

This notice applies to your vehicle: <VIN>

<MODELYEAR> <BRAND> <MODEL>

Transport Canada Recall: 2024-573

Audi Recall: 931B – High-Voltage Battery Modules

INTERIM SAFETY RECALL NOTICE

FREE HIGH-VOLTAGE BATTERY MODULE INSPECTION

This notice is sent to you in accordance with the requirements of the *Motor Vehicle Safety Act*. This is to inform you that your vehicle may contain a defect that could affect the safety of a person. Our records show that you are the owner of a vehicle affected by this action.

About this Recall: Certain high-voltage (HV) batteries may experience short circuits within the battery modules. A short circuit in the high-voltage battery module can increase the risk of a fire.

A recall remedy is not yet available. Audi is working to make a remedy available as quickly as possible and expects the remedy to be available by the end of the 1st quarter of 2025. The recall remedy, when available, will be FREE of charge. We will send you a letter when your dealer has instructions ready to complete it for you.

In the interim, Audi has a FREE high-voltage battery module inspection program for your vehicle ready now. This is not a recall remedy, but an interim step to help monitor your vehicle's high-voltage battery modules until the recall remedy becomes available. Your authorized Audi dealer will inspect the high-voltage battery modules in your vehicle, FREE of charge. This work will take up to four (4) days to complete.

- If the inspection shows all battery modules operating normally, your dealer will schedule a follow-up inspection appointment after 90 days.
- If the inspection shows that a battery module needs replacement, your dealer will order the necessary parts and perform the replacement for you FREE of charge. This work can take up to three (3) days to complete, depending on the number of modules requiring replacement.
- Please contact your authorized Audi dealer to schedule your first FREE high-voltage battery module inspection appointment without delay.

Precautions you should take:

Audi recommends setting the maximum battery charge to 80%. This is an important measure to help protect the high-voltage battery modules in your vehicle until the recall remedy is available.

As always, should you have concerns about your vehicle, please make an appointment with your authorized Audi dealer to have the vehicle concern diagnosed.

Your vehicle owner's manual contains important information about charging your vehicle, and regarding your vehicle's warning lights and messages. We encourage you and anyone who drives your vehicle to review the owner's manual to become familiar with charging procedures, and with the types of vehicle indicators, warnings and messaging you may see.

Your safety and that of your passengers is our highest priority. We apologize for any inconvenience this letter may cause.

Sincerely,

Audi Customer Protection



Audi Audi Canada, P.O. Box 842, Stn. A, Windsor, ON N9A 6P2

If you should have any questions about this communication, please contact Audi Customer Relations Monday through Friday from 8AM to 8PM EST at 1-800-822-2834 or via our "Contact Audi Canada" page at www.audi.ca.

If you are the lessor and registered owner of the vehicle identified in this letter, you shall forward this letter (and any subsequent notice, if applicable) to the lessee within ten (10) days of receipt. If you have changed your address or no longer own the vehicle identified in this letter, please let us know so we can update our records.

Safety Precautions When Working ON the High-voltage System

(additional information is also available in the ELSA Repair Manual)

DANGER

Extremely dangerous due to high voltage.

- The high-voltage system is under heavy voltage. Severe bodily injury or death by electrocution or electric arcs is possible.
- When working on the high-voltage system the high-voltage system must be de-energized.
- When performing procedures that do not directly affect the high-voltage system, in some cases it is still necessary to de-energize the high-voltage system.
- Pay attention when the high-voltage system must be de-energized. Refer to the Repair Manual
- Have a High-Voltage Technician or a High-Voltage Expert de-energize the high-voltage system.

The electric and magnetic fields are extremely dangerous.

- There are electric and magnetic fields on the high-voltage system. Death or serious injury are possible due to malfunction of active implants (for example cardiac pacemakers, insulin pumps).
- Persons with active implants may not perform procedures on the high-voltage system.

WARNING

Risk of injury - motor may start unexpectedly

It is difficult to determine whether the drive system of an electric vehicle or hybrid vehicle is active. Moving parts can trap or draw in parts of the body.

CAUTION

Risk of damage to high-voltage wiring

- Incorrect handling may result in damage to the insulation of high-voltage wires or high-voltage connectors.
- Do not support yourself on high-voltage cables or connectors.
- Never prop tools against high-voltage wiring or high-voltage connectors.
- Never bend or kink high-voltage wiring.
- Observe the coding of the high-voltage connectors when joining them up.

Safety Precautions When Working NEAR the High-voltage System

(additional information is also available in the ELSA Repair Manual)

DANGER

Extremely dangerous due to high voltage.

- The voltage levels in the high-voltage system constitute a safety hazard. Danger of severe or fatal injuries from electric shock if high-voltage components or high-voltage wiring are damaged.
- Carry out a visual check of high-voltage components and high-voltage wiring.
- Never use cutting/forming tools or other sharp-edged implements.
- Never perform work using welding, brazing, thermal bonding or hot air in the area of high-voltage components and high-voltage cables.

 **DANGER**

High voltage increases the risk of fatal injury

Electrocution can cause severe bodily or fatal injury.

- For the following procedures suitable personal protective equipment must be worn.
- For the following steps two correspondingly qualified technicians must be present for the supervision.
- If necessary, a second technician can help the high-voltage expert outside of the hazardous area within their qualification.
- The personal protective equipment (PPE) must be dry and undamaged.

Repair Overview

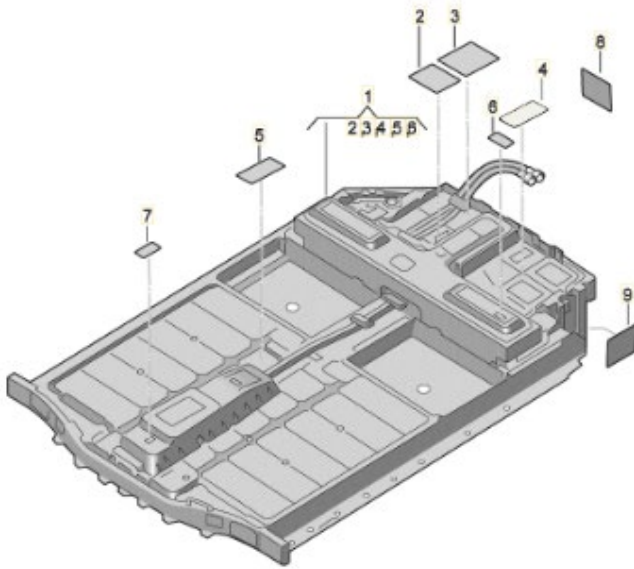

- Complete evaluation of high-voltage battery cell modules.
- Replace cell module(s), if necessary.

CRITICAL REPAIR STEP

 **STOP!** 

A small number of vehicles are assigned both 931A and 931B. If a car does have both codes assigned, the interim 931B inspection must still be completed and claimed under the 931B.

NOTE

- These repair instructions may differ from the labor operations and labor times listed in ELSA.
- Damages resulting from improper repair or failure to follow these work instructions are the dealer's responsibility and are not eligible for reimbursement under this action.
- This procedure must be read in its entirety prior to performing the repair.
- Due to variations in vehicle equipment and options, the steps/illustrations in this work procedure may not identically match all affected vehicles.
- Diagnosis and repair of pre-existing conditions in the vehicle are not covered under this action.
- When working during extreme temperatures, it is recommended that the vehicle be allowed to acclimate inside the shop to avoid temperature-related component damage/breakage.

Required Tools (high-voltage battery evaluation)



Battery Tester/Charger
capable of **minimum 90
Amp** continuous supply



Diagnostic Tester
-VAS6150X/6160X-
(or equivalent)







Required Tools (if HV battery cell module requires replacement)

 <p>Plates for T40424 -T40424/5-</p>	 <p>Module Picker -T40424-</p>
 <p>Lifting Eye -VAS691013-</p>	 <p>Release Tool -T90027-</p>
 <p>Shock-Proof Protection (30 Pcs) -T40421-</p>	 <p>Digital Scale -VAS231007- (or equivalent)</p>
 <p>Spatula kit -VAS281011- (or equivalent)</p>	 <p>Shop Crane -VAS6100- (or equivalent)</p>
 <p>Double Cartridge Adhesive Gun -VAS5237-</p>	 <p>Pneumatic Gun - 10 Bar -VAS6648KIT-</p>
 <p>Window Cutter -VAG1561B-</p>	 <p>Blade Set for VAG1561B -VAG1561A/31-</p>

	<p>Guide Pin (4 Pcs) -T40448-</p>		<p>Test Adapter - Hybrid Module -VAS6558A-</p>
	<p>Plastic Wedge Set -VAS852015-</p>		<p>Double Suction Cups Set - 2Pcs (Similar to VAG1344) -TPK49CUPS-</p>
	<p>Scraper Set -VAS861005- (or equivalent)</p>		<p>Cable Set -VAS6910/12B-</p>
	<p>Connection Line -VAS6910/19-</p>		<p>Module Balancer -VAS6910-</p>
	<p>Support (4 Pcs) -VAS6131/19-</p>		<p>Cooling System Tester for High Voltage Batteries -VAS691005-</p>
	<p>Scissor Lift Table -VAS6131B-</p>		<p>Cartridge Gun -VAG1628- (or equivalent)</p>

	<p>Template -T90023-</p>		<p>High Voltage Tool Set - Voltage Tester -VAS6762/45-</p>
	<p>Adapter Cable -VAS5581/6-</p>		<p>Test Instrument Set -VAS6356-</p>
	<p>Pressure Sensor -VAS611013-</p>		<p>Cooling System Tester -VAG1274B-</p>
	<p>Leak Tester - Test Connector Set -VAS6911/3B-</p>		<p>Digital Pressure Sensor -VAG1397B-</p>
	<p>Cooling System Service Machine -VAS531011-</p>		<p>Spring-Type Clip Pliers -VAS6891- (or equivalent)</p>

 <p>Padlock -T40262/1- (from Service Disconnect Lock -T40262-)</p>	 <p>Frame -T40447-</p>
 <p>Hose Clamps - Up To 25mm -3094- (or equivalent)</p>	 <p>Lifting Tackle -3033-</p>
 <p>Cover -T90028-</p>	 <p>Holding Strap -T40155A- (or equivalent, qty. 2)</p>
 <p>Seal -T40449-</p>	 <p>Shackle (Equivalent to VAS691009A) -VAS691009US- (qty. 2)</p>
 <p>Assembly Tool -T90024B-</p>	 <p>Sealing Plug -T40349-</p>
 <p>Oil Sump Assembly Pin -T40199-</p>	 <p>Depth Gauge -VAS6082- (or equivalent)</p>

	<p>Adapter Cable -VAS5581/1A-2-</p>		<p>Diagnosis Lead -VAS6558A/39-1-</p>
	<p>Diagnosis Lead -VAS6558A/39-2-</p>		<p>High Voltage Diagnostics Box -VAS5581A-</p>
	<p>Insulating Mat -VAS6762/44-</p>		<p>Set of Kelvin Clamps and Test Probes -VAS6558A/27-</p>
	<p>High-voltage tool set -VAS6762A-</p>		<p>High Voltage Tool Set - Torque Wrench -VAS6883/1A</p>
	<p>Insulated Torx Wrench Set - 3/8 -VAS691003A-</p>		<p>Warning Sign - "Do Not Insert" -VAS6871-</p>
	<p>Warning Sign - High Voltage -VAS6649-</p>		<p>Warning Sign - "Do Not Switch On" -VAS6650A-</p>



Warning Sign – Battery
-VAS6786-

Required Shop Materials (if necessary)



Cleaner D -009-401-04
(shop supply)
-OR-
91% Isopropyl Alcohol
(locally sourced)



Lint Free Towels
(locally sourced)



NOTE: Use only 91% Isopropyl alcohol as a cleaner (9% water). Do not use Isopropyl with any additional surfactants (cleaners) or additives (scents).

Repair Instruction

Section A - Check for Previous Repair

TIP

If Campaign Completion label is present, no further work is required.

Applicable criteria ID(s)	Campaign/Action Status
01 	Open 

EXAMPLE

Campaign/Action	Start	Designation
	2015-11-10	W-SERV_ACT -
	2018-12-13	RECALL -
	2017-05-16	A-RECALL -

EXAMPLE

- Enter the VIN in Elsa and proceed to the “Campaign/Action” screen.

TIP

On the date of repair, print this screen and keep a copy with the repair order.

- Confirm the Campaign/Action is open <arrow 1>. If the status is closed, no further work is required.
- Note the Applicable Criteria ID <arrow 2> for use in determining the correct work to be done and corresponding parts associated.

CRITICAL REPAIR STEP



All campaigns/actions with a repair available must be performed in order of the Start date <arrow 3>. The oldest should be performed first (unless otherwise noted in the repair instructions).

CRITICAL REPAIR STEP



All vehicles are assigned criteria SW. Criteria SW is reserved for the final remedy software update.

There are two inspection processes, depending on which criteria is assigned to the vehicle. Be sure to follow the correct process.

- Vehicles with Criteria N1, N2,...,N*:
 - Vehicle had already been to the dealer for an inspection under the 93VN or has previously been to the dealer for an inspection under the 931B.
 - Proceed to Section B
- Vehicles with Criteria F8:
 - No previous inspections have been performed.
 - Proceed to Section C

Section B – Evaluating Need for Cell Module Replacement (Criteria N1, N2, ...,N*. - previous inspection was performed)

! NOTE

Analysis of the high-voltage battery is required to determine if a cell module requires replacement and if so, it's position.

The analysis is carried out by factory representatives, located in Germany. Once the TAC case is created using the directions below, the data will be analyzed, and a response will be provided within 24 hours (in most cases).

The TAC case is created only after all dealer analysis steps are completed.

During the entire evaluation period, the vehicle cannot be released to the customer.

Step 1 – Perform Initial GFF Scan

- Connect a battery maintainer to the 12V battery.
- Switch off all electrical consumers, air conditioning, heater blower motor, lights, heated seats, etc.
- Ensure the latest version of ODIS is downloaded.
- Perform a full diagnostic scan of the vehicle.
- **Wait approx. three minutes for ODIS to gather the vehicle data in the background once the diagnostic scan is completed.**
- Exit GFF.
- Ensure the diagnostic log is sent to GFF Paperless.
- Record the Diagnosis ID from this evaluation step in GFF Paperless.

Step 2 – Charge the High-Voltage Battery

NOTE

This step is needed in the event the data from the original log (from Step 1) was not sufficient. If another log or more information is required, the TAC consultant will provide guidance. Before returning the car to the customer, the vehicle's charge level must be reduced to 80% as outlined in Section E.

CRITICAL REPAIR STEP



Only charge the vehicle using a level 1 or level 2 A/C charger. Do not charge the vehicle using a level 3 D/C fast charger.

- Through the MMI, record the current customer setting for the max charge level.
- Adjust the max charge level to 100%.
- Charge the vehicle's high-voltage battery to 100% via the **A/C connection** on the **driver's** side.
- Disconnect the high-voltage charger after the charging process has been completed.

NOTE

To reduce the charging time, charging at an industrial power outlet, charging station, or wall box is recommended.

Step 3 – Create TAC Case

Sr.No	VIN	Diagnosis ID	Diagnosis Date	Transfer Date (UTC)	Importer / Dealer	DTE (TU)	DTC	Tester ID	Repair Order	Log Status	Log Type
1	[Link]	190682601	2024-10-04	2024-10-04 16:41:48	[Link]	35		f95f6dd0b6e0e42627a8a52a8d454224	[Link]	Final	Guide Fault Findir
2	[Link]	188001740	2024-05-24	2024-05-24 09:10:31	[Link]	24		5ba57f5d792c6d7001ce5708de11af8d	[Link]	Final	Guide Fault Findir

- Record the Diagnosis ID from the first evaluation step from GFF Paperless.

Technical Assistance

Create Ticket

Ticket Information

Concern Type: Technician Email:

Technician Name: Dealer Code:

Vehicle Information

VIN: Make:

Model: Model Year:

Mileage: Engine Code:

Contact Options: I will call now Transmission Code:

I will wait for web response (up to 2 business hours)

Technician Questionnaire

GFF Diagnosis ID:

Enter required worksheet information:

Attachment Type:

- Create a TAC Web Ticket as follows:
 - Select the correct concern group:
 - US DEALERS** - "931B HV Battery Evaluation – Web Ticket Only"
 - CANADIAN DEALERS** - "931B HV Battery Evaluation"
 - Enter your preferred e-mail address.
 - Select "I will wait for a web response."
 - Enter the GFF Diagnosis ID from the first log that was uploaded to GFF Paperless.

⚠ IMPORTANT

The TAC case for analyzing the battery cannot be used for any other direction. If additional TAC assistance is needed (technical direction, cell balancer loaner program, etc.), a separate TAC case will need to be created.

- The response back from Germany may take up to 24 hours.
- During this time, the vehicle cannot be released to the customer.
- If the direction from Germany states no cell modules require replacement:
 - **Proceed to Section E.**
- If the direction from Germany states a cell module requires replacement:
 - Information about which cell module requires replacement will be provided in the TAC case.
 - The vehicle cannot be released to the customer until the module(s) has been replaced.
 - **Proceed to Section D** once all parts and tools are available to complete the repair.

Section C – Evaluating Need for Cell Module Replacement (Criteria F8 - no previous inspections performed)

NOTE

Analysis of the high-voltage battery is required to determine if a cell module requires replacement and if so, it's position.

The analysis is carried out by factory representatives, located in Germany. Once the TAC case is created using the directions below, the data will be analyzed, and a response will be provided within 24 hours (in most cases).

The TAC case is created only after all dealer analysis steps are completed.

During the entire evaluation period, the vehicle cannot be released to the customer.

Step 1 – Perform Initial GFF Scan

- Connect a battery maintainer to the 12V battery.
- Switch off all electrical consumers, air conditioning, heater blower motor, lights, heated seats, etc.
- Ensure the latest version of ODIS is downloaded.
- Perform a full diagnostic scan of the vehicle.
- **Wait approx. three minutes for ODIS to gather the vehicle data in the background once the diagnostic scan is completed.**
- Exit GFF.
- Ensure the diagnostic log is sent to GFF Paperless.
- Record the Diagnosis ID from this evaluation step in GFF Paperless.

Step 2 – Charge the High-Voltage Battery

CRITICAL REPAIR STEP



Only charge the vehicle using a level 1 or level 2 A/C charger. Do not charge the vehicle using a level 3 D/C fast charger.

- Through the MMI, record the current customer setting for the max charge level.
- Adjust the max charge level to 100%.
- Charge the vehicle's high-voltage battery to 100% via the **A/C connection** on the **driver's** side.
- Disconnect the high-voltage charger after the charging process has been completed.

NOTE

To reduce the charging time, charging at an industrial power outlet, charging station, or wall box is recommended.

Step 3 – Waiting Period #1

IMPORTANT REPAIR INFORMATION

After the high-voltage battery has been charged to 100%, the vehicle should be parked in an area where it can remain for the duration of the evaluation. Once parked, the vehicle should not be moved or have electrical consumers used unless specified by the work instructions. Moving the vehicle or using electrical consumers will affect the high-voltage battery charge level and may lead to an inaccurate evaluation of the high-voltage battery.

- Remove any battery chargers.
- Park the vehicle in the evaluation area.
- Remove the ignition key from the vehicle.
- Close all doors and lids.
- Lock the vehicle.
- Allow the vehicle to sit for **at least six hours**.
- Reconnect the battery maintainer to the 12V battery.
- Perform a full diagnostic scan of the vehicle.
- **Wait approx. three minutes for ODIS to gather the vehicle data in the background once the diagnostic scan is completed.**
- Exit GFF.
- Ensure the diagnostic log is sent to GFF Paperless.
- Record the Diagnosis ID from this evaluation step in GFF Paperless.

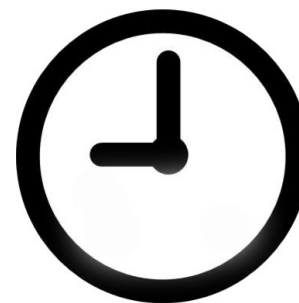

Step 4 – Waiting Period #2

- Remove any battery chargers, if installed.
- Remove the ignition key from the vehicle.
- Close all doors and lids.
- Lock the vehicle.
- Allow the vehicle to sit for **at least 66 hours (sixty-six hours)**.
- Reconnect the battery maintainer to the 12V battery.
- Perform a full diagnostic scan of the vehicle.
- **Wait approx. three minutes for ODIS to gather the vehicle data in the background once the diagnostic scan is completed.**
- Exit GFF.
- Ensure the diagnostic log is sent to GFF Paperless.
- Record the Diagnosis ID from this evaluation step in GFF Paperless.

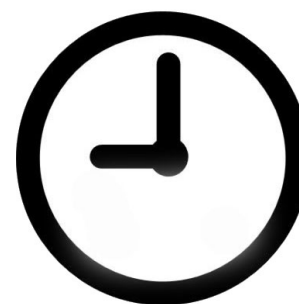

Step 5 – Create TAC Case

Sr.No	VIN	Diagnosis ID	Diagnosis Date	Transfer Date (UTC)	Importer / Dealer	DTE (TU)	DTC	Tester ID	Repair Order	Log Status	Log Type
1	[Link]	190682601	2024-10-04	2024-10-04 16:41:48	[Link]	35		f95f6dd0b6e0e42627a8a52a8d454224	[Link]	Final	Guide Fault Findir
2	[Link]	188001740	2024-05-24	2024-05-24 09:10:31	[Link]	24		5ba57f5d792c6d7001ce5708de11af8d	[Link]	Final	Guide Fault Findir

- Record the Diagnosis ID from the first evaluation step from GFF Paperless.

Technical Assistance

Create Ticket

Ticket Information

Concern Type: Technician Email:

Technician Name: Dealer Code:

Vehicle Information

VIN: Make:

Model: Model Year:

Mileage: Engine Code:

Contact Options: I will call now Transmission Code:

I will wait for web response (up to 2 business hours)

Technician Questionnaire

GFF Diagnosis ID:

Enter required worksheet information:

Attachment Type:

- Create a TAC Web Ticket as follows:
 - Select the correct concern group:
 - US DEALERS** - "931B HV Battery Evaluation – Web Ticket Only"
 - CANADIAN DEALERS** - "931B HV Battery Evaluation"
 - Enter your preferred e-mail address.
 - Select "I will wait for a web response."
 - Enter the GFF Diagnosis ID from the first log that was uploaded to GFF Paperless.

⚠ IMPORTANT

The TAC case for analyzing the battery cannot be used for any other direction. If additional TAC assistance is needed (technical direction, cell balancer loaner program, etc.), a separate TAC case will need to be created.

- The response back from Germany may take up to 24 hours.
- During this time, the vehicle cannot be released to the customer.
- If the direction from Germany states no cell modules require replacement:
 - **Proceed to Section E.**
- If the direction from Germany states a cell module requires replacement:
 - Information about which cell module requires replacement will be provided in the TAC case.
 - The vehicle cannot be released to the customer until the module(s) has been replaced.
 - **Proceed to Section D** once all parts and tools are available to complete the repair.

Section D – Replace Cell Module(s)

⚠ CRITICAL REPAIR STEP

STOP STOP

Before balancing the new cell module(s), be sure that the vehicle is ready for the repair to be performed.

If possible, the high voltage battery should be de-energized right after recording the voltage reading to avoid possible voltage variations.

Charging the vehicle, driving the vehicle, leaving the ignition on, or running the HVAC can change the high voltage battery voltage.

After reading out the mean cell module voltage from the MVBs, avoid moving the vehicle if possible. The vehicle must not be charged or have any electrical consumers used. If this step is not followed, there is a risk that the new cell module(s) will not be balanced correctly resulting in possible faults and having to remove and re-balance the cell module(s) again.

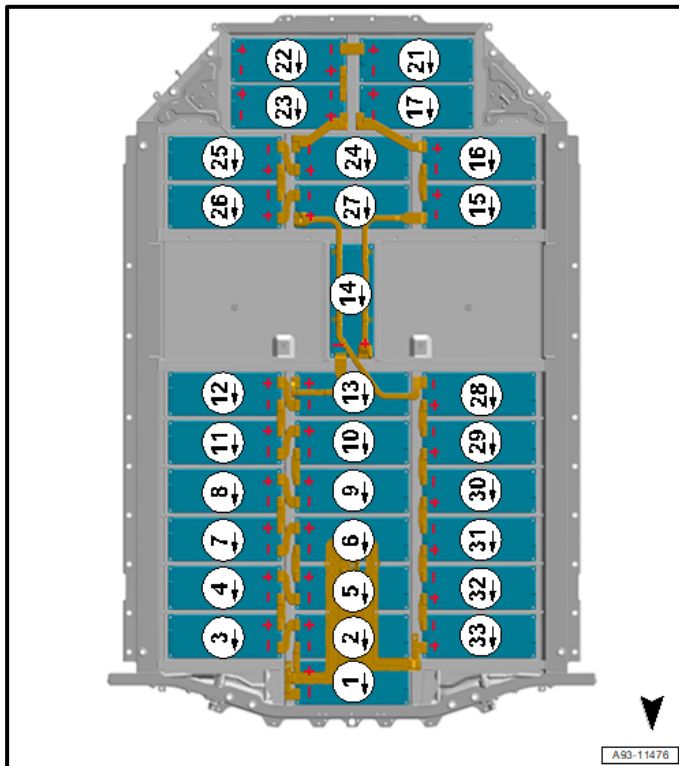

Cell module(s) replacement determination:

- Refer to the TAC case response from Germany to determine which cell module(s) requires replacement.

NOTE

Cell modules 18, 19, 20 are found on level 2. All other cell modules are found on level 1.

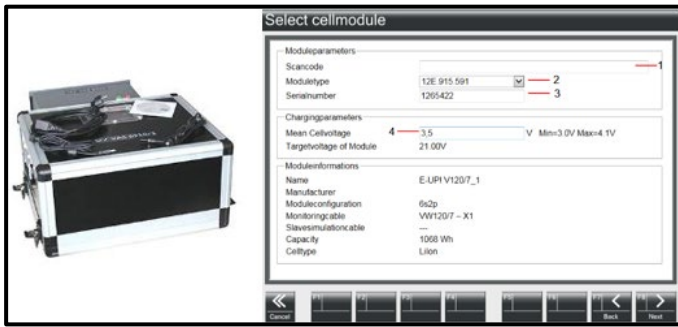

Balance the new cell module(s):

- Determine the average cell module voltage per the ELSA repair manual:
 - *Repair manual > Engine > Electric Drive Motor OEG > 93 Electric drive > High-Voltage Battery Unit > Average Cell Voltage, Determining.*
- Balance the new cell module(s) per the ELSA repair manual:
 - *Repair manual > Engine > Electric Drive Motor OEG > 93 Electric drive > High-Voltage Battery Unit > Battery Modules, Charging and Discharging.*
- Follow the VAS6910 operating instructions in conjunction with the DSS Manager program to perform the cell balancing on the new cell module.

i TIP

Operating instructions for the VAS6910 and DSS Manager program can be found on the Audi Special Tools and Equipment website.



Image shown may not be actual product.
Product and price information are subject to change without notice.

Module Balancer
Model: VAS6910

Price: **\$12,984.18 ***
log in for dealer pricing.
Available
[Add To Cart](#)

Notes

DSS Manager OperatingManual Rev02
OperatingManual Rev10
VAS 6910 Unpacking Instruction and Start-Up EN rev12

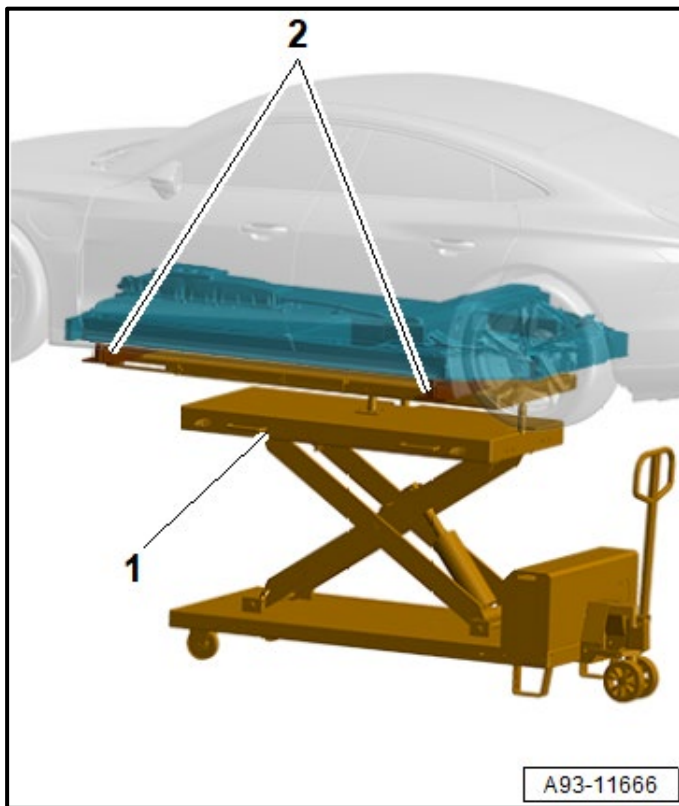

High-voltage battery removal:

DANGER

There is a risk of fatal injury due to high voltage. Electrocutation by direct contact or electric arc can cause severe bodily injury or fatal injury.

Have a high-voltage technician or a high-voltage expert de-energize the high-voltage system.

- Remove the high-voltage battery from the vehicle per the ELSA repair manual:
 - *Repair manual > Engine > Electric Drive Motor OEG > 93 Electric drive > High-Voltage Battery Unit > High-Voltage Battery 1 AX2, Removing and Installing.*
- Note the following when removing the high-voltage battery:
 - Mark the position of the scissor lift table on the floor to aid in repositioning the table during reinstallation.
 - Pay close attention to all wiring harnesses when lowering the battery.
 - Pay close attention to all coolant hoses when lowering the battery.

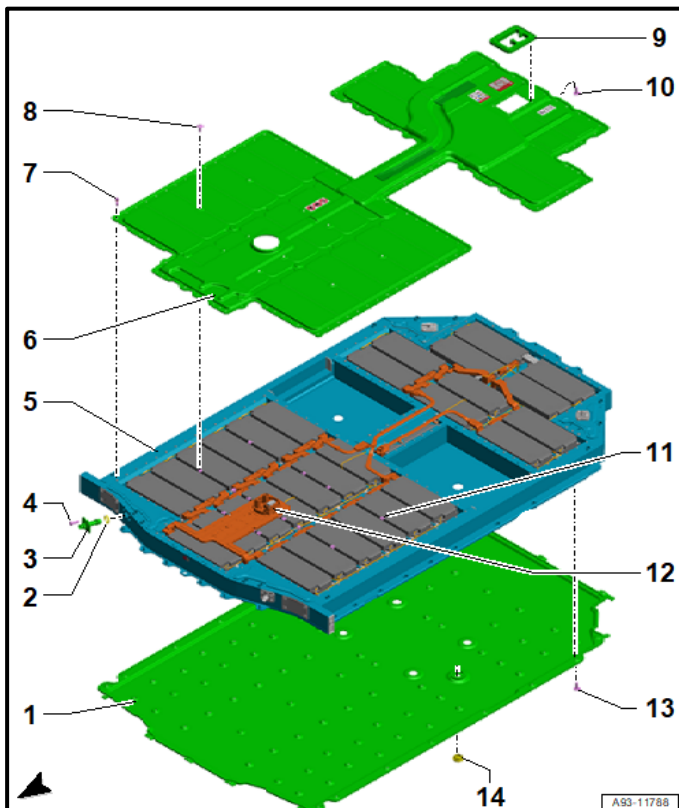

Remove the high voltage battery cover(s):

⚠ DANGER

There is a risk of fatal injury due to high voltage. Severe bodily injury or death by electrocution or electric arcs is possible.

The following procedures may only be performed by a qualified high-voltage expert HVE.

⚠ DANGER

There is a risk of fatal injury due to high voltage. Electrocution by direct contact or electric arc can cause severe bodily injury or fatal injury.

- For the following procedures suitable personal protective equipment must be worn.
- For the following steps two correspondingly qualified technicians must be present for the supervision.
- If necessary, a second technician can help the high-voltage expert outside of the hazardous area within their qualification.
- The personal protective equipment (PPE) must be dry and undamaged.

⚠ CRITICAL REPAIR STEP



RISK OF SEVERE CONSEQUENTIAL DAMAGE!

USE HAND TOOLS ONLY!

Do not use power tools to remove any of the bolts. Using power tools to remove the bolts can damage the threads in the lower housing. Claims for lower housing replacements due to improper bolt removal will be denied.

⚠ CAUTION

Risk of damaging the high-voltage battery components due to incorrect handling.

Pay close attention to the ELSA repair manual cautions.

- Clean off any debris that has accumulated on the battery housing prior to opening.

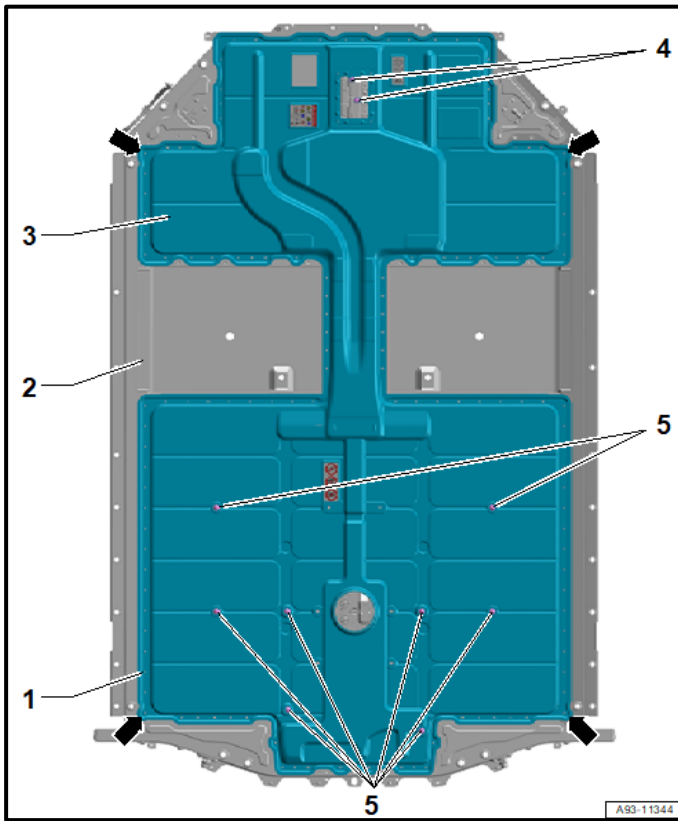

- Refer to the ELSA repair manual for high-voltage battery cover removal:
 - **Layer 1 module replacement:**
Repair manual > Engine > 93 Electric drive > High-Voltage Battery Components > Battery Housing Cover, Removing and Installing > Cover for Battery Housing Layer 1, Removing and Installing.
 - **Layer 2 module replacement:**
Repair manual > Engine > 93 Electric drive > High-Voltage Battery Components > Battery Housing Cover, Removing and Installing > Cover for Battery Housing Layer 2, Removing and Installing.

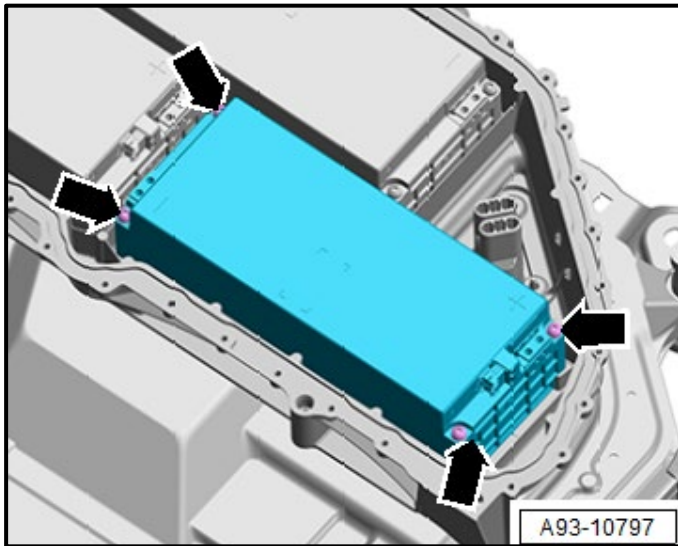

Replace the affected cell module(s):

<p>⚠ DANGER</p>
<p>There is a risk of fatal injury due to high voltage. Severe bodily injury or death by electrocution or electric arcs is possible.</p> <p>Pay very close attention to the Repair Manual steps.</p>

- Replace the affected cell module(s) per the ELSA repair manual:
 - **Cell module(s) removal:**
Repair manual > Engine > 93 Electric drive > High-Voltage Battery Components > Battery Module, Removing.
 - **Cell module(s) installation:**
Repair manual > Engine > 93 Electric drive > High-Voltage Battery Components > Battery Module, Installing.

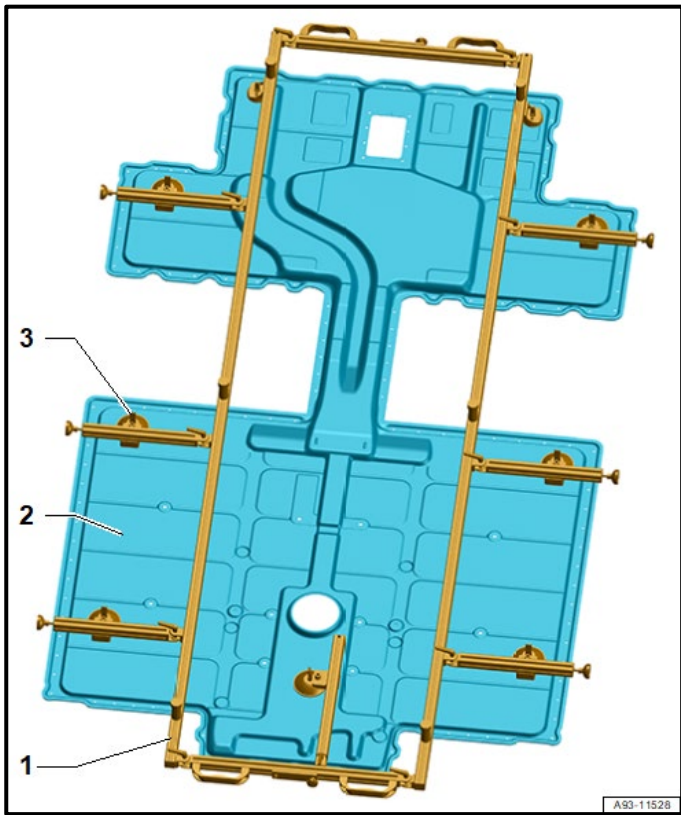

Install the high-voltage battery cover(s):

- Refer to the ELSA Repair Manual for battery cover installation:
 - **Layer 1 battery cover installation:**
Repair manual > Engine > 93 Electric drive > High-Voltage Battery Components > Battery Housing Cover, Removing and Installing > Cover for Battery Housing Layer 1, Removing and Installing.
 - **Layer 2 battery cover installation:**
Repair manual > Engine > 93 Electric drive > High-Voltage Battery Components > Battery Housing Cover, Removing and Installing > Cover for Battery Housing Layer 2, Removing and Installing.



NOTE

Referencing the position of the labels on the old battery covers when installing the new battery covers can aid in positioning of the new labels.



Re-install high-voltage battery:

⚠ WARNING

There is a risk of fatal injury due to high voltage. Electrocutation by direct contact or electric arc can cause severe bodily injury or fatal injury.

Have a high-voltage technician or a high-voltage expert bring the high-voltage system back into service.

- Installation is the reverse order of removal.
- Install the high-voltage battery into the vehicle per the ELSA repair manual:
 - *Repair manual > Engine > Electric Drive Motor 0EG > 93 Electric drive > High-Voltage Battery Unit > High-Voltage Battery 1 AX2, Removing and Installing.*



Classify the removed cell module(s):

⚠ CAUTION

There is danger of a health risk due to poisonous vapors, dust, and fluids.

Never work on high-voltage batteries that have a short circuit.

⚠ CAUTION

There is a risk of burns due to a hot high-voltage battery. It is possible to burn hands.

Wear safety gloves.

- Classify the removed cell module(s) per the ELSA repair manual:
 - *Repair manual > Engine > 93 Electric drive > High-Voltage Battery Components > Battery Module, Visual Inspection and Classification.*

Proceed to section E

Section E – Final Steps Before Returning Vehicle to Customer



Set return appointment:

- Set a return appointment at least 90 days from the date of the inspection visit.

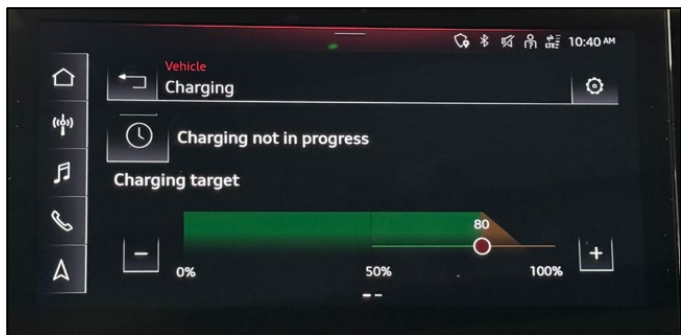

Ensure max charging level is set to 80% in the MMI:

- Home
- Vehicle
- Charging and Efficiency
- Charging
- Press and hold green bar to move Target charge rate to 80%

If no modules required replacement:

- This monitoring visit is complete.

If one or more modules required replacement:

- US DEALERS - Proceed to Section F
- CANADIAN DEALERS - Proceed to Section G
- This monitoring visit is complete.

Section F - Parts Return/Disposal – US DEALERS ONLY

High-Voltage Battery Module(s):

Refer to the latest instructions for high-voltage battery recycling, found in Elsa2Go: *Elsa2Go-> Infomedia->Service References->Electric Vehicle Category ->“HV Battery Recycling Program Guide”*

All other parts:

Properly store (retain), destroy or dispose of removed parts in accordance with all state/province and local requirements, unless otherwise indicated and/or requested through the Warranty Parts Portal (WPP).

Section G - Parts Return/Disposal – CANADIAN DEALERS ONLY

High-Voltage Battery Module(s):

Refer to the latest version of TSB 2062871.

All other parts:

Properly store (retain), destroy or dispose of removed parts in accordance with all state/province and local requirements, unless otherwise indicated and/or requested through the Part Destruction and Core Disposition Report for Canada.