

# Safety Recall

## Code: 47UP



### Subject Front Axle Brake Hoses

#### Document History

Date	Summary
11/07/2024	Updated work instructions: Information added on checking and fitting retaining spring on bracket for wheel bearing housing
09/28/2024	Updated claiming and work instructions.
09/05/2024	Updated work instructions to clarify direction brake hose fitting may have to be rotated.
09/04/2024	Updated work instructions and parts information
07/30/2024	Original publication

#### Affected Vehicles

Country	Beginning Model Year	Ending Model Year	Vehicle	Vehicle Count
USA	2022	2024	E-TRON GT	7,011
USA	2022	2024	RS E-TRON GT	2,642
CAN	2022	2024	E-TRON GT	536
CAN	2022	2024	RS E-TRON GT	211

Check Campaigns/Actions screen in Elsa on the day of repair to verify that a VIN qualifies for repair under this action. Elsa is the only valid campaign inquiry & verification source.

- ✓ Campaign status must show "open."
- ✓ If Elsa shows other open action(s), inform your customer so that the work can also be completed at the same time the vehicle is in the workshop for this campaign.

#### Problem Description

It is possible that, over time, tears can develop in the front axle brake hoses. If this happens, a brake fluid leak and eventually brake circuit failure could occur. A failed brake circuit can cause longer brake pedal travel, reduced vehicle braking capability, and longer stopping distances, increasing the risk of a crash.

#### Corrective Action

Replace the front axle brake hoses with new, optimized brake hoses and holder.

#### Precautions

If the recall condition is present in the vehicle, brake pedal travel may be extended, and a warning message will appear in the vehicle display due to the reduced quantity of brake fluid. Customers experiencing this condition are advised to contact their authorized Audi dealer to have the vehicle diagnosed without delay.

#### Code Visibility

On June 25, 2024, the campaign code was applied to affected vehicles.

#### Owner Notification

Owner notification will take place in August 2024. Owner letter examples are included in this bulletin for your reference.

#### Additional Information

**Please alert everyone in your dealership about this action, including Sales, Service, Parts and Accounting personnel. Contact Warranty if you have any questions.**

**IMPORTANT REMINDER ON VEHICLES AFFECTED BY SAFETY & COMPLIANCE RECALLS**

**New Vehicles in Dealer Inventory: It is a violation of federal law for a dealer to deliver a new motor vehicle or any new or used item of motor vehicle equipment (including a tire) covered by this notification under a sale or lease until the defect or noncompliance is remedied. By law, dealers must correct, prior to delivery for sale or lease, any vehicle that fails to comply with an applicable Federal Motor Vehicle Safety Standard or that contains a defect relating to motor vehicle safety.**

**Pre-Owned Vehicles in Dealer Inventory: Dealers should not deliver any pre-owned vehicles in their inventory which are involved in a safety or compliance recall until the defect has been remedied.**

Dealers must ensure that every affected inventory vehicle has this campaign completed before delivery to consumers.

## Parts Information

Criteria	Quantity	Part Number	P.O.C. Part Description	Ordering Method (see description below)
02	1	9J1-611-707-K	HOSE (left front)	Reference POC comments individually by part number, or in the POC Campaign List
	1	9J1-611-708-K	HOSE (right front)	
03	1	9J1-611-707-L	HOSE (left front)	
	1	9J1-611-708-L	HOSE (right front)	
04	1	9J1-611-707-M	HOSE (left front)	
	1	9J1-611-708-M	HOSE (right front)	
ALL	1	9J1-611-845-C	BRACKET (left front)	
	1	9J1-611-846-C	BRACKET (right front)	
	4	N -100-829-13	BOLT	
	Up to 0.5 L	See POC	Brake Fluid	

**Initial Allocation:**

**NO**

There will be no parts allocation.

**NOTE**

Your dealer's Estimated Remaining Repairs by campaign can be found in Parts on Command. Click on "View Campaign List" and review the Estimated Remaining Repairs column.

**NOTE**

Campaign parts should always be ordered as per the parts information in this circular. The ordering system will supersede the part, if applicable.

## Claim Entry Instructions

The labor times listed here may differ from the labor operations and labor times listed in ELSA.

After campaign has been completed, enter claim as soon as possible to help prevent work from being duplicated elsewhere. Attach the Elsa screen print showing action *open on the day of repair* to the repair order.

If a customer declines campaign work, refer to the “Customer Declines Campaign/Update Repair” section in the Campaign/Update Policy and Procedures Manual.

<b>Service Number</b>	47UP
<b>Damage Code</b>	0099
<b>Parts Vendor Code</b>	002
<b>Claim Type</b>	Sold vehicle: 7 10 Unsold vehicle: 7 90
<b>Causal Indicator</b>	Mark any HOSE* as causal part
<b>Vehicle Wash</b>	Do not claim wash under this action
<b>Vehicle Loaner</b>	See special claiming instructions for rental/loaner claiming. <b>NOTE: A 2nd claim must be entered for rental/loaner claiming</b>

**Vehicles will have more than one criteria.  
Complete and claim all applicable criteria on one claim.**

### LABOR

Criteria	Labor Op	Time Units	Description
ALL	4726 20 50	SEE ELSA	2 Front brake hose remove+reinstall
	4405 20 00	SEE ELSA	2 Wheels remove+reinstall
	2706 89 50	SEE ELSA	Connect battery charger <i>(if necessary)</i>
	0150 00 60	Time stated on diagnostic protocol	GFF/Guided Functions <i>(if necessary)</i>

### PARTS

Criteria	Quantity	Part Number	Description
01 and 02	1.00	9J1611707K	HOSE (left front)
	1.00	9J1611708K	HOSE (right front)
01 and 03	1.00	9J1611707L	HOSE (left front)
	1.00	9J1611708L	HOSE (right front)
01 and 04	1.00	9J1611707M	HOSE (left front)
	1.00	9J1611708M	HOSE (right front)
ALL	1.00	9J1611845C	BRACKET (left front)
	1.00	9J1611846C	BRACKET (right front)
	4.00	N 10082913	BOLT
	Up to 5.00	B 000750S0	Brake Fluid

<b>Vehicle Loaner (if required)</b>	<b>Enter vehicle loaner claim as a separate (2<sup>nd</sup>) claim</b> <i><b>NOTE: The vehicle loaner claim must be entered after the campaign work claim is entered</b></i>		
	<b>Claim Type</b>	7 MO	(letter O, not number 0)
	<b>Service Number</b>	47UP	
	<b>Damage Code</b>	0010	
	<b>Parts Vendor Code</b>	002	
	<b>Outside Labor Operation</b>	LOAN1600	Enter dollar amount on rental/loaner invoice: <b>US Dealers</b> - \$50 max per day <b>Canadian Dealers</b> - \$60 max per day <b>Maximum of 1 day</b>

## Customer Letter Example (USA)

<MONTH YEAR>

<CUSTOMER NAME>

<CUSTOMER ADDRESS>

<CUSTOMER CITY STATE ZIPCODE>

**This notice applies to your vehicle:** <MODEL YEAR> <BRAND> <CARLINE>, <VIN>

**NHTSA:** 24V465

**Subject: Safety Recall 47UP – Front Axle Brake Hoses**

Dear Audi Owner,

This notice is sent to you in accordance with the National Traffic and Motor Vehicle Safety Act. Audi has decided that a defect, which relates to motor vehicle safety, exists in certain 2022-2024 model year Audi vehicles. Our records show that you are the owner of a vehicle affected by this action.

### **What is the issue?**

It is possible that, over time, tears can develop in the front axle brake hoses. If this happens, a brake fluid leak and eventually brake circuit failure could occur. A failed brake circuit can cause longer brake pedal travel, reduced vehicle braking capability, and longer stopping distances, increasing the risk of a crash.

### **What will we do?**

To correct this defect, your authorized Audi dealer will replace the front axle brake hoses with new, optimized brake hoses and holder. This work will take about two hours to complete and will be performed for you free of charge. Please keep in mind that your dealer may need additional time for the preparation of the work, as well as to accommodate their daily workshop schedule.

### **What should you do?**

Please contact your authorized Audi dealer without delay to schedule this recall work. For your convenience, you can also visit [www.audiusa.com](http://www.audiusa.com) and click on the “Find a Dealer” link to locate a dealer near you and schedule this service.

### **Precautions you should take:**

If the recall condition is present in the vehicle, brake pedal travel may be extended, and a warning message will appear in the vehicle display due to the reduced quantity of brake fluid. Customers experiencing this condition are advised to contact their authorized Audi dealer to have the vehicle diagnosed without delay.

### **Additional Information**

- If you are the lessor and registered owner of the vehicle identified in this action, the law requires you to forward this letter immediately via first-class mail to the lessee within ten (10) days of receipt.
- If your authorized Audi dealer fails or is unable to complete this work free of charge within a reasonable time, if you have changed your address or sold the vehicle, or if you should have any questions about this communication, please contact Audi Customer Experience at 1-800-253-2834 or via our “Contact Us” page at [www.audiusa.com](http://www.audiusa.com).
- If you still cannot obtain satisfaction, you may file a complaint with: The Administrator, National Highway Traffic Safety Administration, 1200 New Jersey Avenue, SE., Washington, DC 20590; or call the toll-free Vehicle Safety Hotline at 1-888-327-4236 (TTY: 1-800-424-9153); or go to <http://www.safercar.gov>.
- To check your vehicle’s eligibility for repair under this or any other recall/service campaign, please visit the Recall/Service Campaign Lookup tool at [www.audiusa.com](http://www.audiusa.com) and enter your Vehicle Identification Number (VIN).
- If you have previously paid for repairs relating to the condition described in this letter, the enclosed form explains how to request reimbursement. We would be pleased to review your reimbursement request.

We apologize for any inconvenience this matter may cause; however, we are taking this action to help ensure your safety and continued satisfaction with your vehicle.

Sincerely,

Audi Customer Protection

## Customer Letter Example (Canada)

<MONTH YEAR>

<CUSTOMER NAME>

<CUSTOMER ADDRESS>

<CUSTOMER CITY STATE ZIPCODE>

**This notice applies to your vehicle:** <MODEL YEAR> <BRAND> <CARLINE>, <VIN>

**Transport Canada Recall:** 2024-355

**Subject: Safety Recall 47UP – Front Axle Brake Hoses**

Dear Audi Owner,

This notice is sent to you in accordance with the requirements of the *Motor Vehicle Safety Act*. This is to inform you that your vehicle may contain a defect that could affect the safety of a person. Our records show that you are the owner of a vehicle affected by this action.

### **What is the issue?**

It is possible that, over time, tears can develop in the front axle brake hoses. If this happens, a brake fluid leak and eventually brake circuit failure could occur. A failed brake circuit can cause longer brake pedal travel, reduced vehicle braking capability, and longer stopping distances, increasing the risk of a crash.

### **What will we do?**

To correct this defect, your authorized Audi dealer will replace the front axle brake hoses with new, optimized brake hoses and holder. This work will take about two hours to complete and will be performed for you free of charge. Please keep in mind that your dealer may need additional time for the preparation of the work, as well as to accommodate their daily workshop schedule.

### **What should you do?**

Please contact your authorized Audi dealer without delay to schedule this recall work.

### **Precautions you should take:**

If the recall condition is present in the vehicle, brake pedal travel may be extended, and a warning message will appear in the vehicle display due to the reduced quantity of brake fluid. Customers experiencing this condition are advised to contact their authorized Audi dealer to have the vehicle diagnosed without delay.

### **Additional Information**

- If you are the lessor and registered owner of the vehicle identified in this letter, you shall forward this letter (and any subsequent notice, if applicable) to the lessee within ten (10) days of receipt.
- If your authorized Audi dealer fails or is unable to complete this work free of charge within a reasonable time, if you have changed your address or sold the vehicle, or if you should have any questions about this communication, please contact Audi Customer Relations Monday through Friday from 8AM to 8PM EST at 1-800-822-2834 or via our "Contact Audi Canada" page at [www.audi.ca](http://www.audi.ca).
- If you have previously paid for repairs relating to the condition described in this letter, the enclosed form explains how to request reimbursement. We would be pleased to review your reimbursement request.

We apologize for any inconvenience this matter may cause; however, we are taking this action to help ensure your safety and continued satisfaction with your vehicle.

Sincerely,

Audi Customer Protection

## Repair Overview

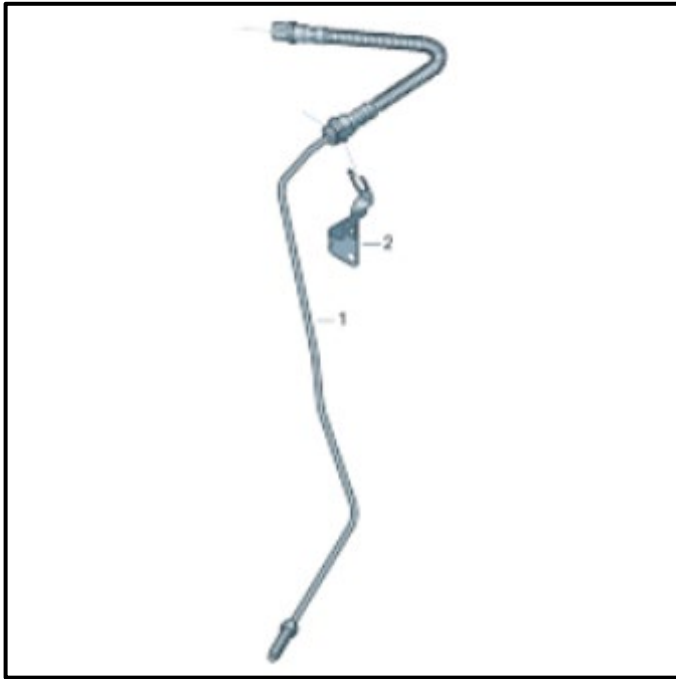





- Replace driver and passenger front flexible brake hoses and brackets.

### NOTE

- These repair instructions may differ from the labor operations and labor times listed in ELSA.
- Damages resulting from improper repair or failure to follow these work instructions are the dealer's responsibility and are not eligible for reimbursement under this action.
- This procedure must be read in its entirety prior to performing the repair.
- Due to variations in vehicle equipment and options, the steps/illustrations in this work procedure may not identically match all affected vehicles.
- Diagnosis and repair of pre-existing conditions in the vehicle are not covered under this action.
- When working during extreme temperatures, it is recommended that the vehicle be allowed to acclimate inside the shop to avoid temperature-related component damage/breakage.

## Required Tools

 <p>Brake Pedal Actuator -VAG1869/2- (or equivalent)</p>	 <p>Brake Filling and Bleeding Equipment -VAS6860US- (or equivalent)</p>
 <p>Brake Bleeding Tool Set -VAS6564- (or equivalent)</p>	 <p>Wrench – Brake Bleeder Set -VAS5519- (or equivalent)</p>
 <p>Safety Gloves and Safety Goggles</p>	

## Repair Instruction

### Section A - Check for Previous Repair

Applicable criteria ID(s)	Campaign/Action Status
01 ← 2	Open ← 1

**EXAMPLE**

Campaign/Action	Start	Designation
→ 3	2015-11-10	W-SERV_ACT -
	2018-12-13	RECALL -
	2017-05-16	A-RECALL -

**EXAMPLE**

- Enter the VIN in Elsa and proceed to the “Campaign/Action” screen.

#### TIP

On the date of repair, print this screen and keep a copy with the repair order.

- Confirm the Campaign/Action is open <arrow 1>. If the status is closed, no further work is required.
- Note the Applicable Criteria ID <arrow 2> for use in determining the correct work to be done and corresponding parts associated.

#### CRITICAL REPAIR STEP

 **STOP!** 

All campaigns/actions with a repair available must be performed in order of the Start date <arrow 3>. The oldest should be performed first (unless otherwise noted in the repair instructions).

- **Proceed to Section B.**

## Section B – Repair Procedure

### **⚠ WARNING**

#### **Risk of accident!**

Make sure the brakes are working correctly before driving the vehicle for the first time.

### **⚠ WARNING**

#### **Risk of injury due to the acidic nature of brake fluid!**

Avoid contact with skin.

### **⚠ CAUTION**

#### **Risk of damage due to improper handling of the brake fluid.**

- Avoid contact with paintwork.
- Avoid brake fluid contact with fluids containing mineral oils (oil, gas, cleaning solutions).

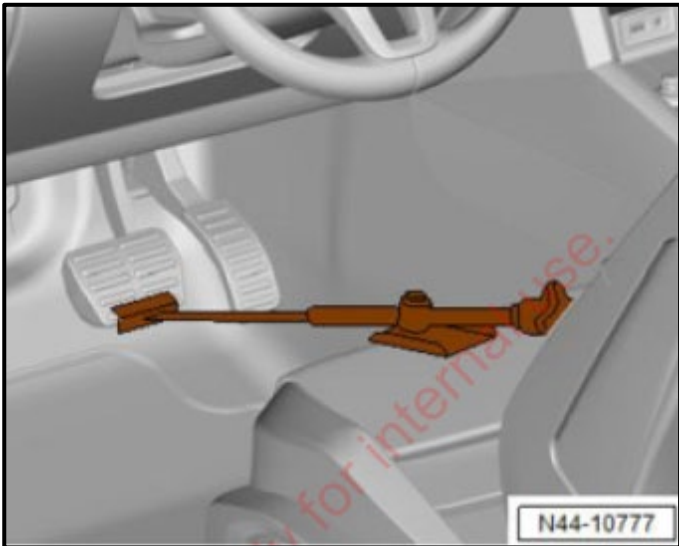

### **⚠ IMPORTANT**

Do not remove the brake pedal depressor until instructed to do so.

- Depress the brake pedal at least 60mm and install the pedal depressor -VAG1869/2-.

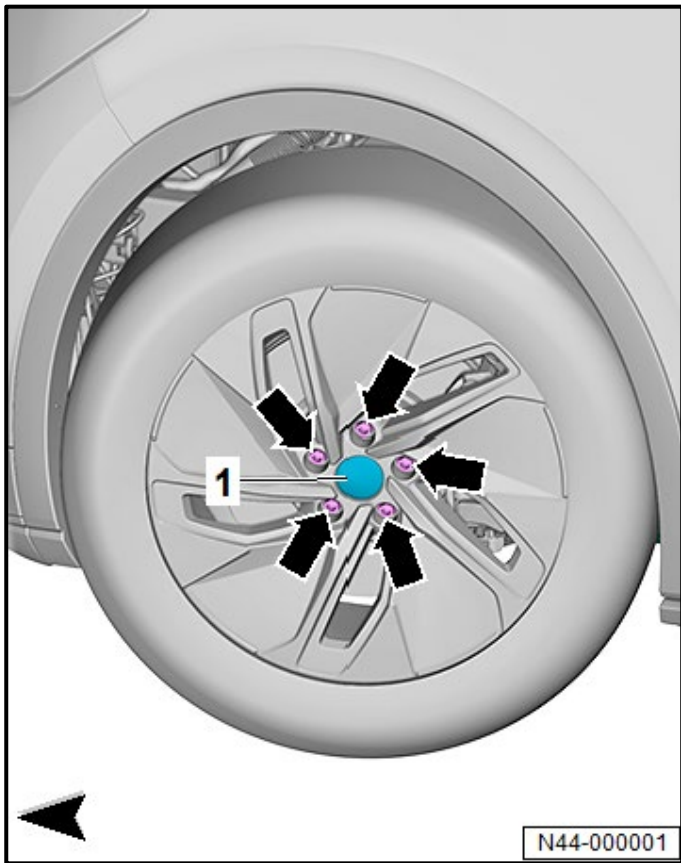

- Remove both front wheels per the ELSA repair manual:
  - *Repair manual > Chassis > Brake System > Suspension, Wheels, Steering > 44 Wheels, Tires, Wheel Alignment > Wheels and Tires > Wheel, Removing and Installing.*

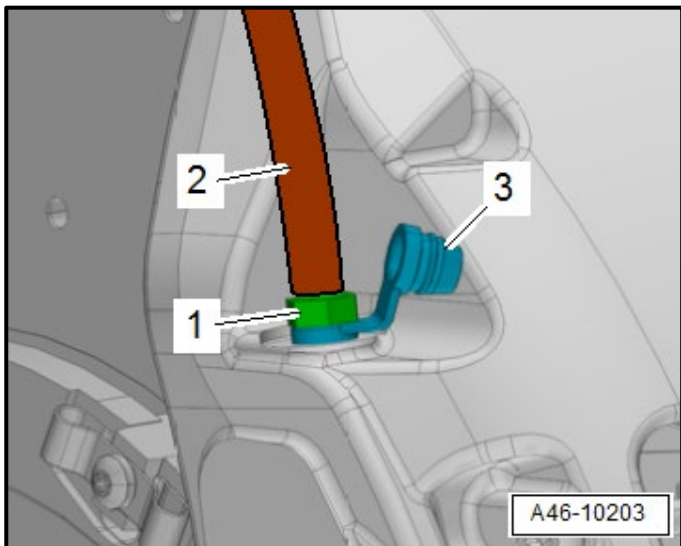

- Remove protective cap <3> from bleeder screw <1> on the driver front brake caliper.
- Connect the hose <2> from the bleeder bottle.
- Open the bleeder screw <1> to lower pressure in the hydraulic system.
- Close the bleeder screw <1> and remove bleeder bottle.
- Repeat these steps on the passenger front caliper.

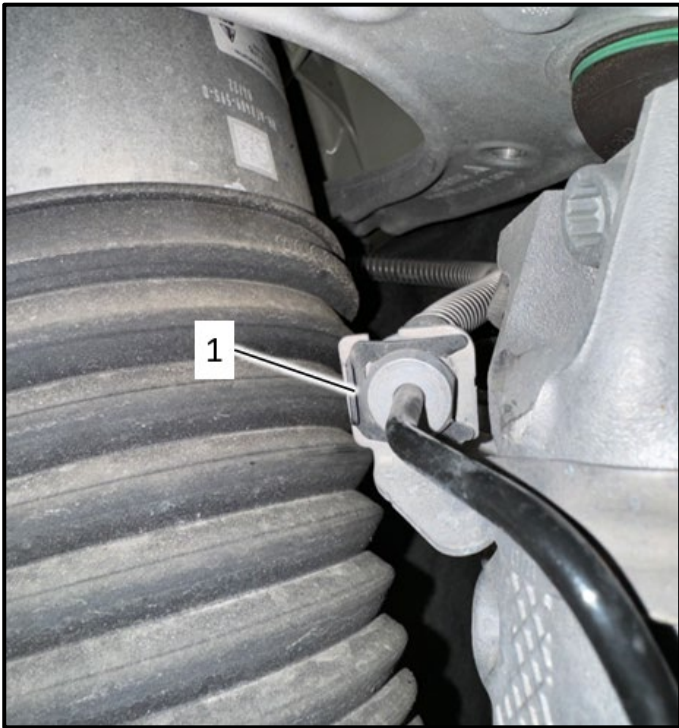

**NOTE**

The steps below outline the replacement of the driver front brake hose and bracket. Replacement of the passenger front brake hose and bracket is similar.

- Remove the spring clip <1> and set to the side as it will be reused.

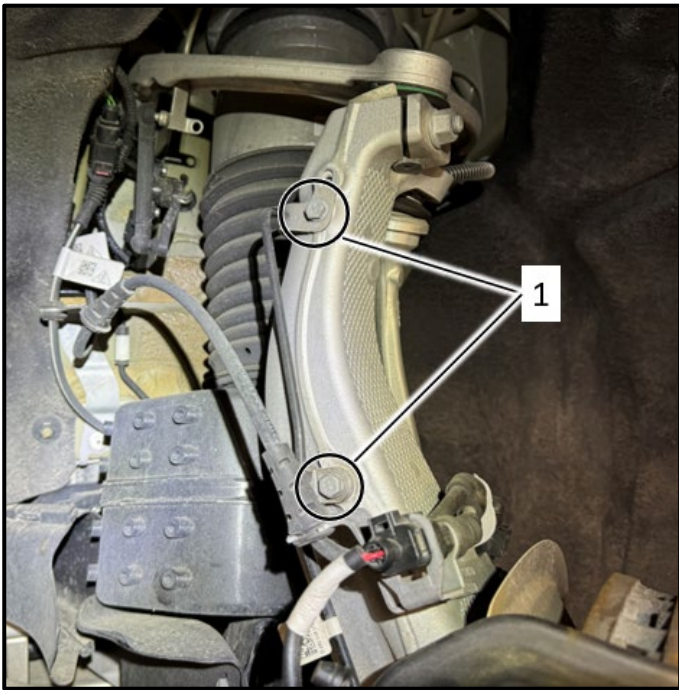

**NOTE**

The bolts <1> are one time use fasteners and will not be reused.

- Remove the bolts <1>.

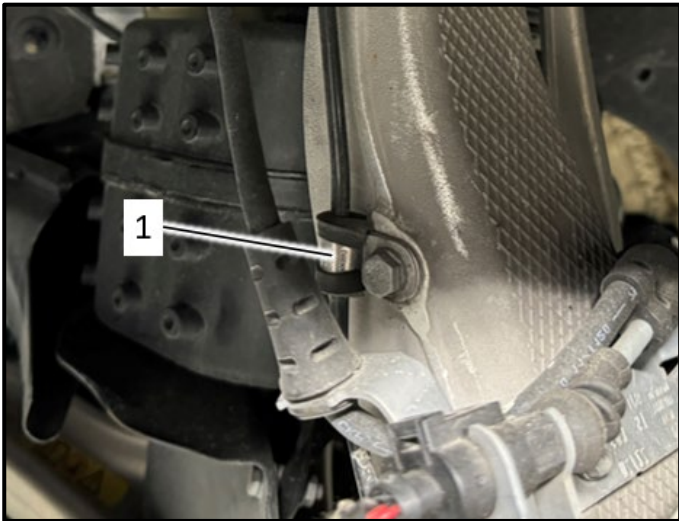

- Remove the bracket <1> and set to the side as it will be reused.

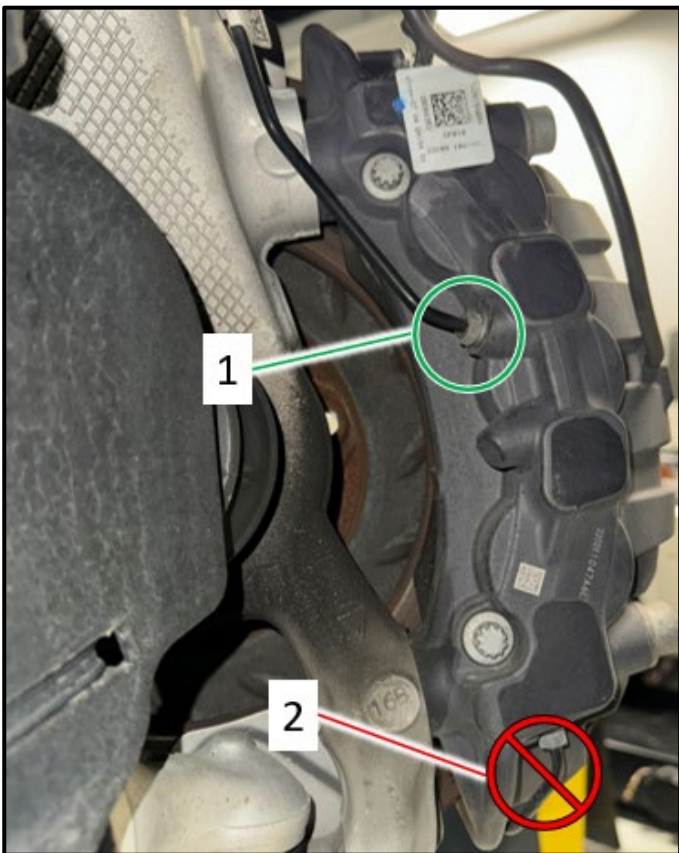

**! IMPORTANT**

The lower brake line <2> is not removed during this repair. Do not loosen or disconnect this line.

- Place a lint-free cloth under the brake hose to catch any escaping brake fluid.
- Loosen the brake hose connection <1> and remove it from the brake caliper.
- Seal any open brake fluid circuit connection points using suitable caps or plugs that are clean and free of debris.

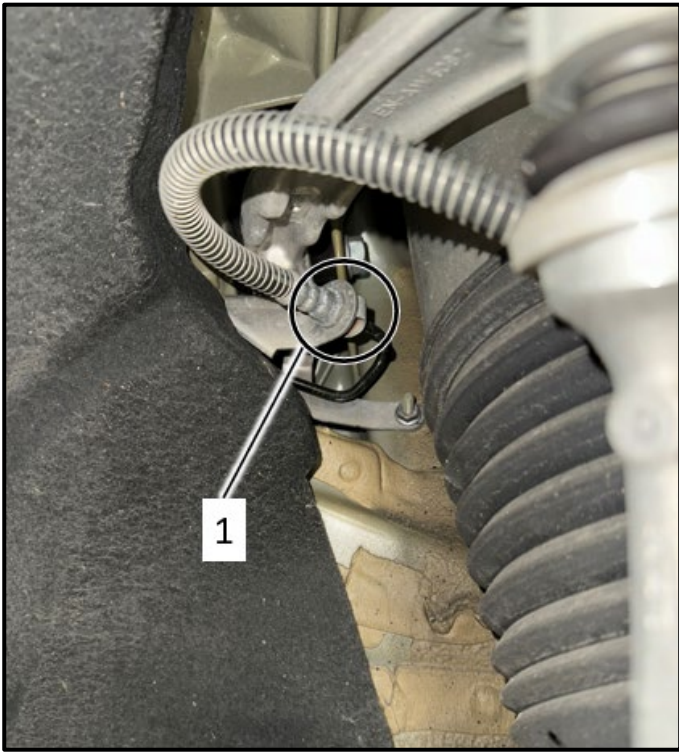

- Locate the upper brake hose connection <1> in the wheel well.

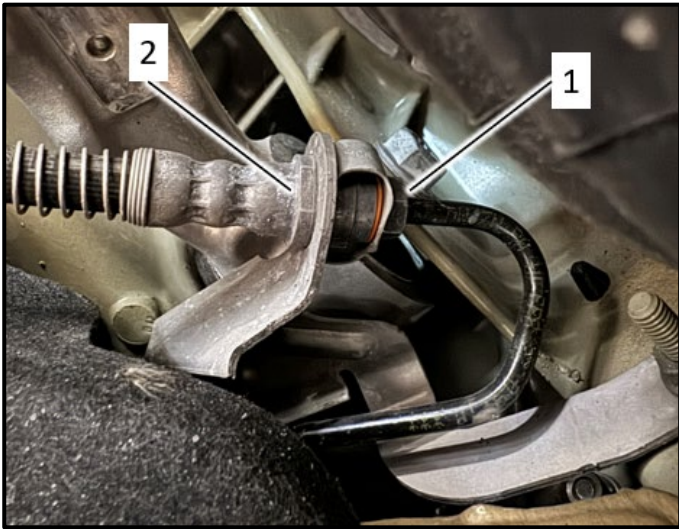

- Place a lint-free cloth under the brake hose connection to catch any escaping brake fluid.
- Loosen and separate the brake line connection <1> while counter-holding the brake hose connection <2>.
- Seal any open brake fluid circuit connection points using suitable caps or plugs that are clean and free of debris.

**i TIP**

A 15 mm wrench will fit the brake hose connection <2>.

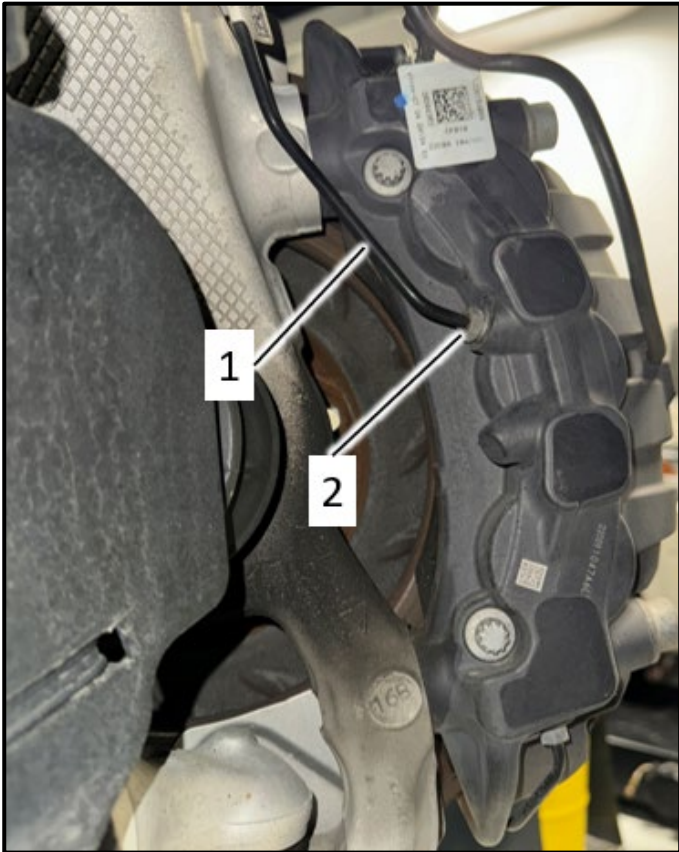
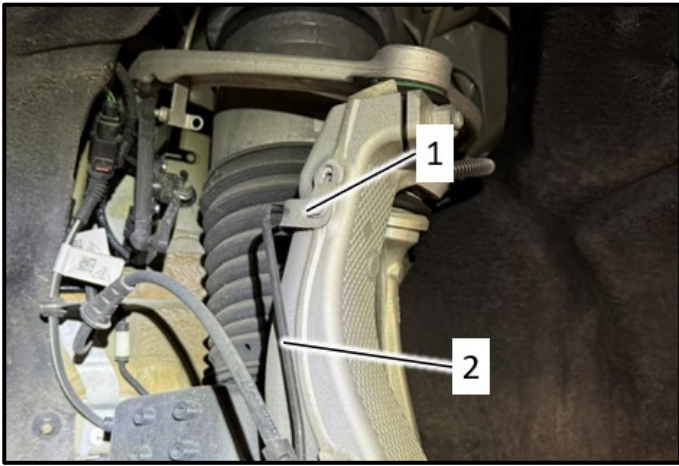

**NOTE**

Prior to removing the brake hose, take note of the hose routing.

- Remove the bracket <1> and brake hose <2> from the vehicle.

- Install the new brake hose <1>.
- Remove any sealing caps and/or plugs.
- Loosely thread the brake hose connection <2> into the caliper, but do not fully tighten.

**NOTE**

Ensure the new brake hose is routed correctly. The brake hose must not be kinked, bent, or twisted. It should not contact the suspension or body when the vehicle suspension is loaded.

Criteria	Part Number	Part Description
02	9J1-611-707-K	Brake hose (driver side)
	9J1-611-708-K	Brake hose (passenger side)
03	9J1-611-707-L	Brake hose (driver side)
	9J1-611-708-L	Brake hose (passenger side)
04	9J1-611-707-M	Brake hose (driver side)
	9J1-611-708-M	Brake hose (passenger side)

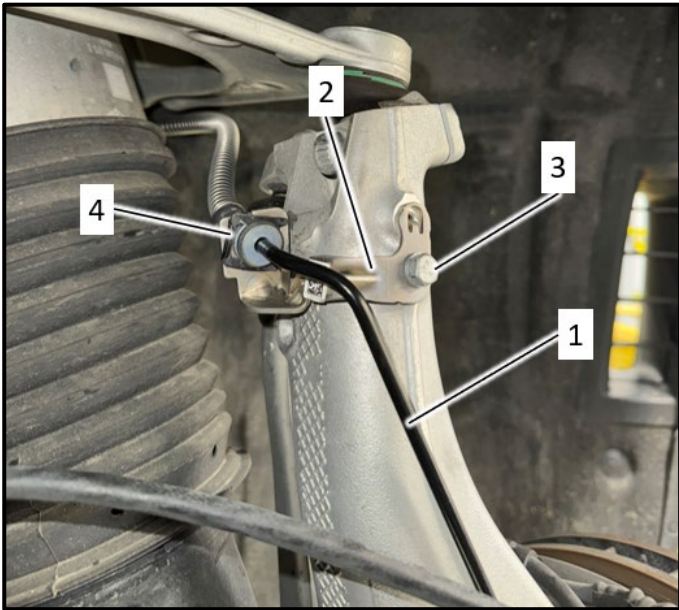

- Install the new bracket <2>.
- Loosely install a new bolt <3>.
- Install the previously removed spring clip <4>.

Criteria	Part Number	Part Description
All	9J1-611-845-C	Bracket (driver side)
	9J1-611-846-C	Bracket (passenger side)
	N -100-829-13	Bolt (x2)

**NOTE**

The new brake hose bracket <1> is an updated design. This will cause the new brake hose to sit in a slightly different position. This is normal.

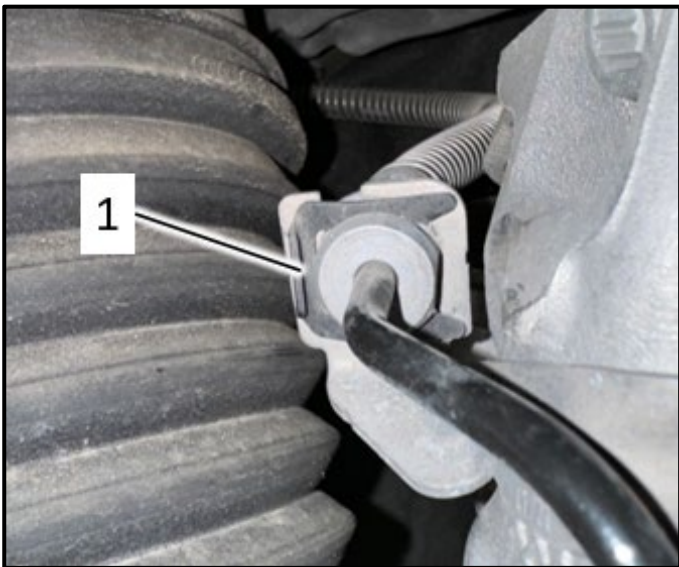

- Ensure the brake line retaining clip <1> is installed exactly as shown. The protrusion on the clip must face outward.
- If the clip is missing, it must be replaced.

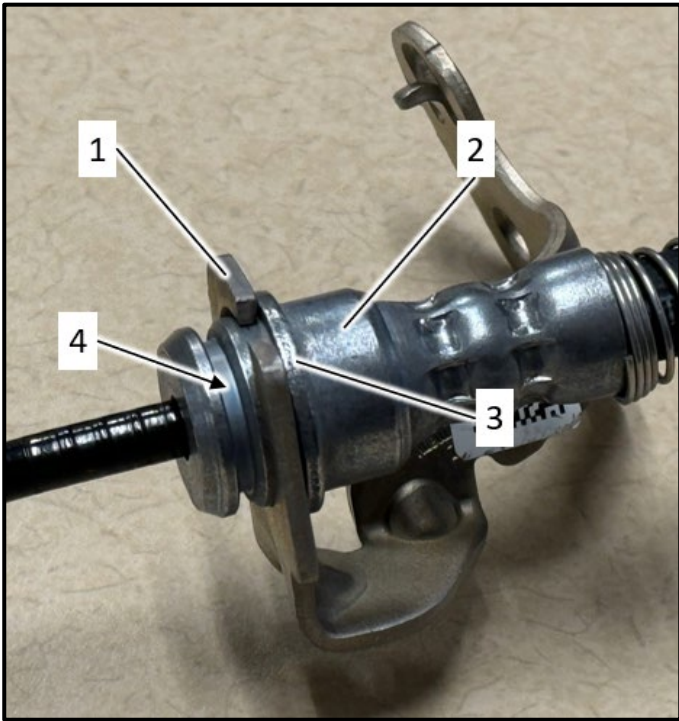

**NOTE**

The brake hose bracket <1> and brake hose junction <2> are keyed. When installed properly, the bracket <1> is fully seated against the retaining collar <3> which allows the recess for the spring clip <4> to be fully exposed.

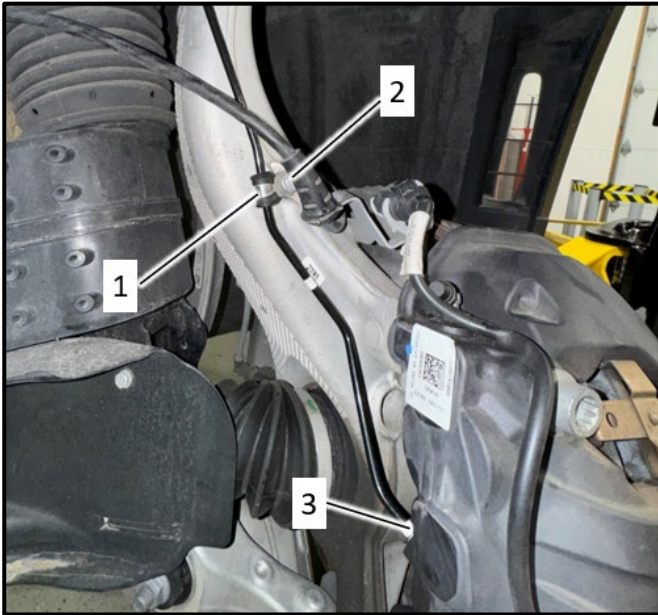

- Install the previously removed bracket <1>.
- Loosely install a new bolt <2>.
- Tighten the caliper connection <3> to 14 Nm.

Criteria	Part Number	Part Description
ALL	N -100-829-13	Bolt (x2)

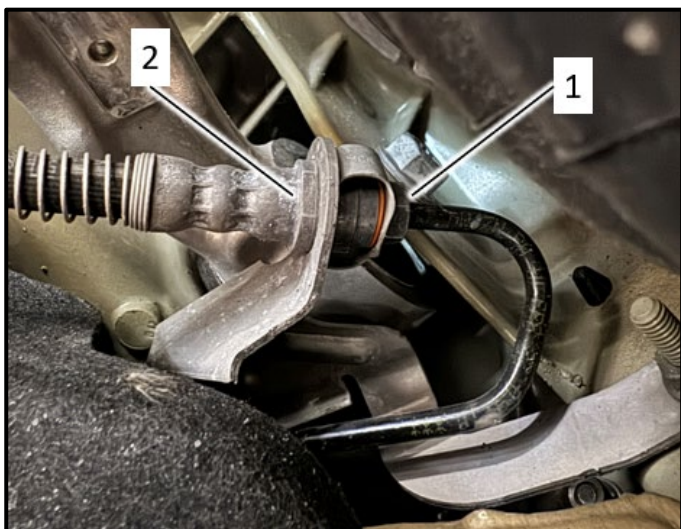
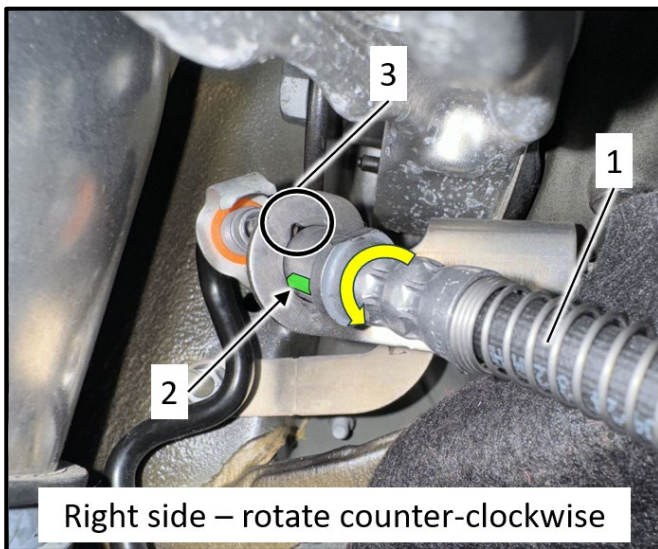
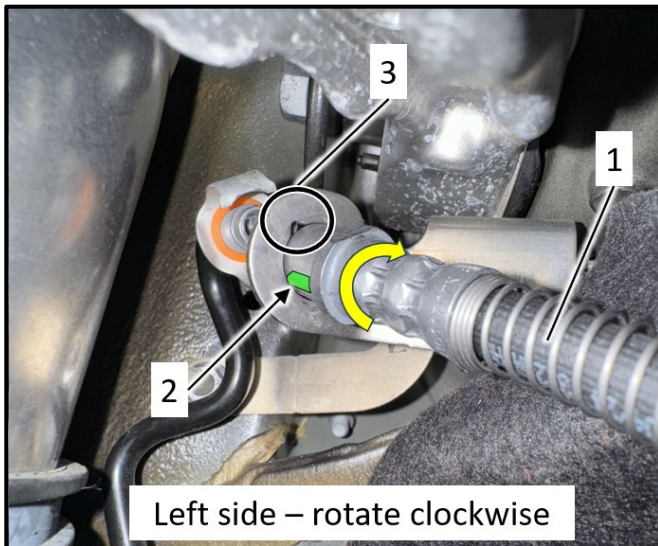

**NOTE**

Contact between the brake hose and the upper control arm may occur directly after installation. As the brake hose relaxes, contact no longer occurs. The hose will have to be twisted slightly during installation (with suspension fully extended on the lifting platform). When the suspension is compressed, this tension is reduced.

- Remove any sealing caps and/or plugs.
- Rotate the new brake hose <1> until the key <2> lines up with the slot in the bracket <3>.
  - **Left side of vehicle** – rotate hose **clockwise**.
  - **Right side of vehicle** – rotate hose **counter-clockwise**.

- Connect the new brake hose to the brake line in the wheel well.
- Tighten the brake line connection <1> to 14 Nm while counter-holding the connection <2>.



- The brake hose <1> is correctly installed and shown with the vehicle suspension extended.



- The brake hose <1> is correctly installed and shown with the vehicle suspension loaded.



- The brake hose <1> was rotated in the wrong direction and is incorrectly installed.

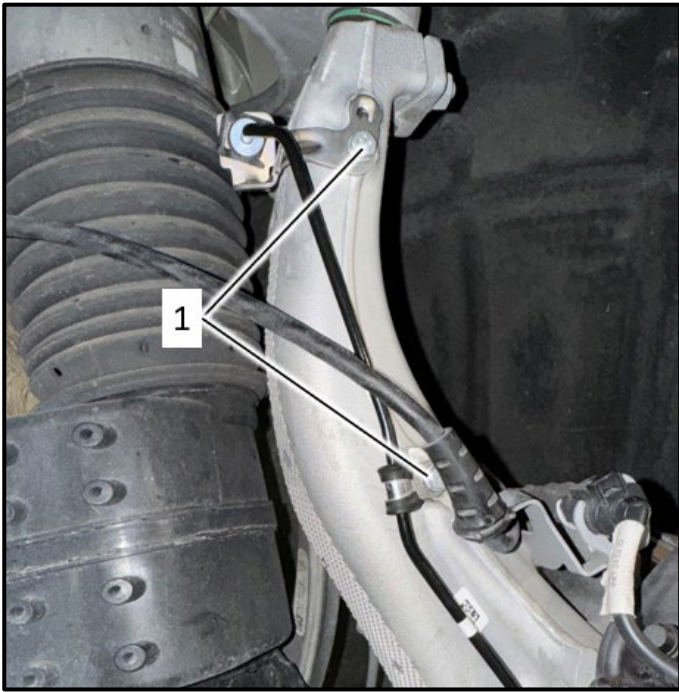

- Tighten the new bolts <1> to 8 Nm.

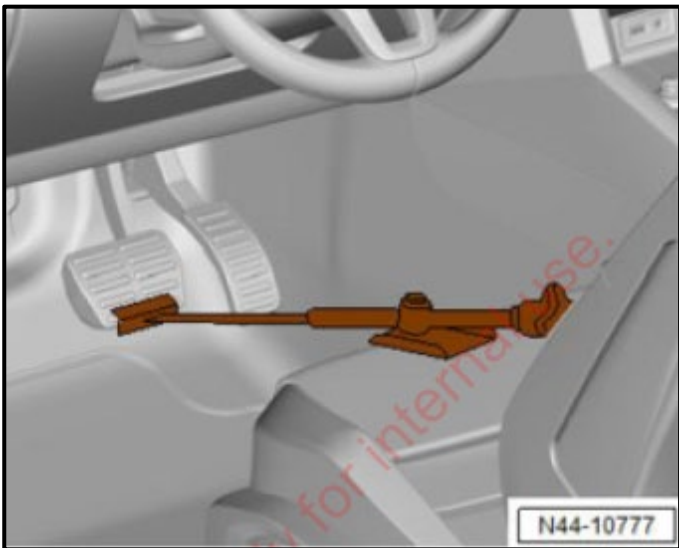

- Remove the brake pedal depressor -VAG1869/2-.

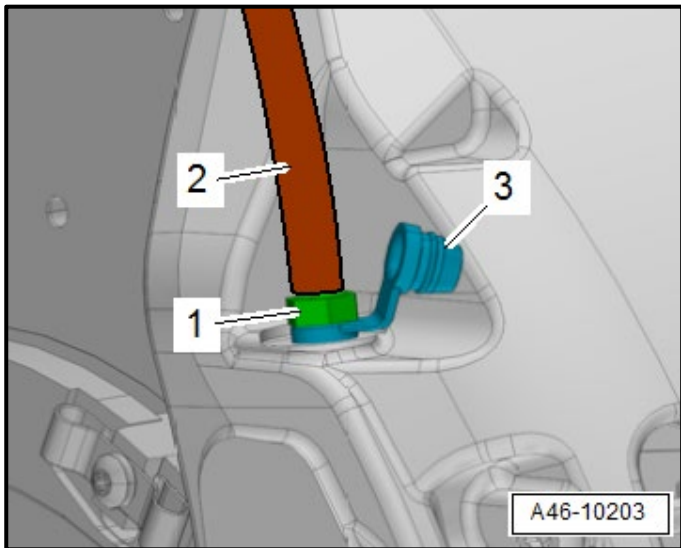

**! IMPORTANT**

The front and rear brake fluid circuits are separate in e-Tron GT vehicles. Bleeding of the rear brake fluid circuit is not required during this repair.

- Bleed the **front brakes** following the ELSA repair manual, following the section for “Conventional bleeding”, being sure to omit the steps for bleeding the rear brakes:
  - *Repair manual > Chassis > Brake System > 47 Hydraulic Components > Hydraulic System > Hydraulic System, Bleeding.*

**! NOTE**

If the brake hoses are replaced and the brake pedal actuator is used correctly, conventional bleeding on the front left and right brakes is sufficient. Check brake pedal travel and brake pedal pressure after bleeding. If pedal travel and/or pressure is not OK, perform bleeding procedure with diagnostic tester.

- Reassemble the vehicle in the reverse order of removal while noting the following:
  - Tighten the front wheels to 160 Nm.

**Proceed to Section C.**

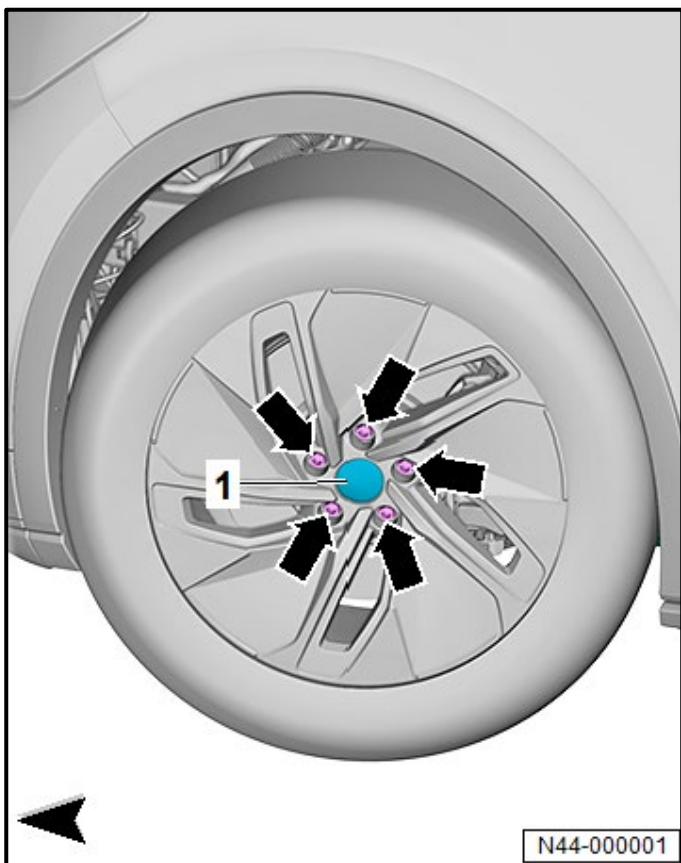

## Section C – Campaign Completion Stamp

I certify that this campaign  
has been performed in strict  
accordance with the applicable  
Audi repair procedure.

SAGA Code: \_\_\_\_\_  
Technician: \_\_\_\_\_  
Date: \_\_\_\_\_

Item#: AUD4927ENG

-OR-

Je certifie que cette  
campagne de rappel a été  
exécutée suivant les strictes  
directives de réparation  
d'Audi

Code de SAGA: \_\_\_\_\_  
Technicien: \_\_\_\_\_  
Date: \_\_\_\_\_

Item # AUD4927FRE

- Once the campaign has been completed, the technician should stamp the repair order.
- Stamps are available for ordering through the Compliance Label Ordering Portal.
- **Proceed to Section D.**

## Section D - Parts Return/Disposal

Properly store (retain), destroy or dispose of removed parts in accordance with all state/province and local requirements, unless otherwise indicated and/or requested through the Warranty Parts Portal (WPP) for U.S. and the Part Destruction and Core Disposition Report for Canada.