

TECHNICAL INSTRUCTIONS

FOR

SAFETY RECALL 24LA04

ENGINE MAY STALL DURING DRIVING

CERTAIN MODEL YEAR 2022 - 2023 LX 600

Updated

02.21.2025 – Updated Oil Quantity and Engine Oil Level Step

02.28.2025 – Revised Catalytic Converter Removal/Installation Process

03.13.2025 – Updated Engine Hoist Height Adjustment Note, Added Damaged Engine Flow Chart and Added Wiper Cowl Removal/Installation Steps

04.07.2025 – Updated Technician Training

06.05.2025 – Updated Engine Wire Installation Step

The repair quality of covered vehicles is extremely important to Lexus. All dealership technicians performing this recall are required to successfully complete the most current version of the E-Learning course “Safety Recall and Service Campaign Essentials”. To ensure that all vehicles have the repair performed correctly; technicians performing this repair are required to currently have completed the following courses:

- LIC201A Engine Repair
- LES001A V35A-FTS
- LER024A- 24LA04 Engine Replacement Process and Best Practices

Always check which technicians can perform the repair by logging on to <https://www.uotdealerreports.com>. The dealership is responsible for selecting technicians who have completed the above courses to perform this repair. Carefully review your resources, the technician’s skill level, and ability before assigning technicians to this repair. It is important to consider technician days off and vacation schedules to ensure properly trained technicians are available to perform this repair at all times.

I. DAMAGED ENGINE SHIPMENT FLOW CHART

The flow chart is for reference only. Follow TAS case creation process below to ensure concern is resolved quickly.

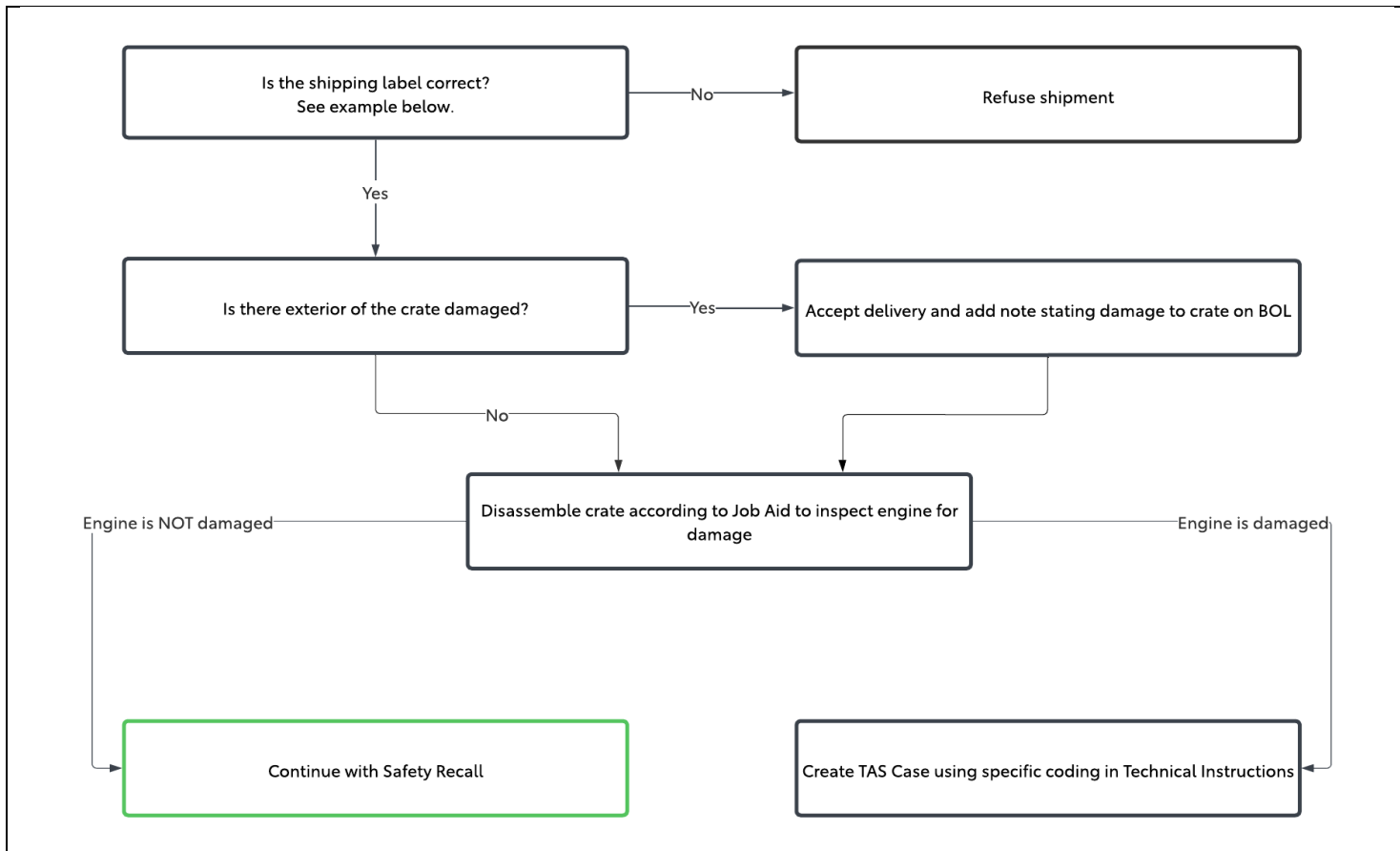

1. Case Type

- a. Select "Documentation Only" for TAS Case Creation
- b. Enter VIN
- c. Enter Repair Order Date
- d. Enter Repair Order
- e. Enter Odometer
- f. Confirm Miles/KM
- g. Enter Visits for Concern
- h. Enter Customer Type
- i. Select "Save and Continue"

TAS - Technical Assistance System

Case Type ⓘ

Technical Documentation Only Collision Center Parts Release

Select "Documentation Only"

Vehicle Information

VIN *Required	Year	Model	Case Creation Date
<input type="text" value="██████████"/>	2022	Tundra	Jan 30, 2025
Repair Order Date *Required	Repair Order *Required	Odometer *Required	Miles/KM *Required
<input type="text" value="Jan 28, 2025"/> ⓘ	<input type="text" value="123456"/>	<input type="text" value="12500"/>	<input type="text" value="Miles"/> ▼
Dealer Visits for Concern *Required	Customer Type *Required		
<input type="text" value="1"/> ▼	<input type="text" value="Private Owner"/> ▼		

Technician Information

Technician Name *Required	Dealer Code / Name *Required	Dealer Phone Number	Direct Contact Phone *Required
<input type="text" value="██████████"/>	<input type="text" value="██████████"/>	<input type="text" value="██████████"/>	<input type="text" value="██████████"/>

2. Case Details

- a. Enter Customer Concern as 24TA07 – Describe damage to engine
 - i. Example: 24TA07 – Dipstick Tube damaged
- b. Select “Powertrain” as Service Group
- c. Select “Engine/Hybrid System” as Service Category
- d. Select “Engine Mechanical” as Section
- e. Select “Fluid Dip Stick” as Sub-Component
- f. Select “Design/Less than Expectation” as Condition
- g. Select “N/A” as Pre-Call Worksheet
- h. Select “Save and Continue”

The screenshot shows the 'Case Details' step in the TAS - Technical Assistance System. The interface includes a progress bar at the top with five steps: General Information (checked), Case Details (active, highlighted with a '2'), Diagnostic Information (checked), Review (checked), and Submitted (5). Below the progress bar, the 'Case Details' section contains the following fields:

- Customer Concern *Required:** A text input field containing '24TA07 - Dip Stick Tube Damaged'. Below the field is the text 'Limit 10,000 characters'.
- Service Group *Required:** A dropdown menu with 'Powertrain' selected.
- Service Category *Required:** A dropdown menu with 'Engine/Hybrid System' selected.
- Section *Required:** A dropdown menu with 'Engine Mechanical' selected.
- Sub-Component *Required:** A dropdown menu with 'Fluid Dip Stick' selected.
- Condition *Required:** A dropdown menu with 'Design/Less Than Expectation' selected.
- Pre-Call Worksheet *Required:** A dropdown menu with 'N/A' selected.

At the bottom of the form, there are three buttons: 'Save and Continue' (highlighted in blue), 'Back', and 'Cancel'.

3. Diagnostic Information

- a. Provide description of damage
- b. Provide clear photos showing damage to engine/crate
- c. Select "Save and Continue"

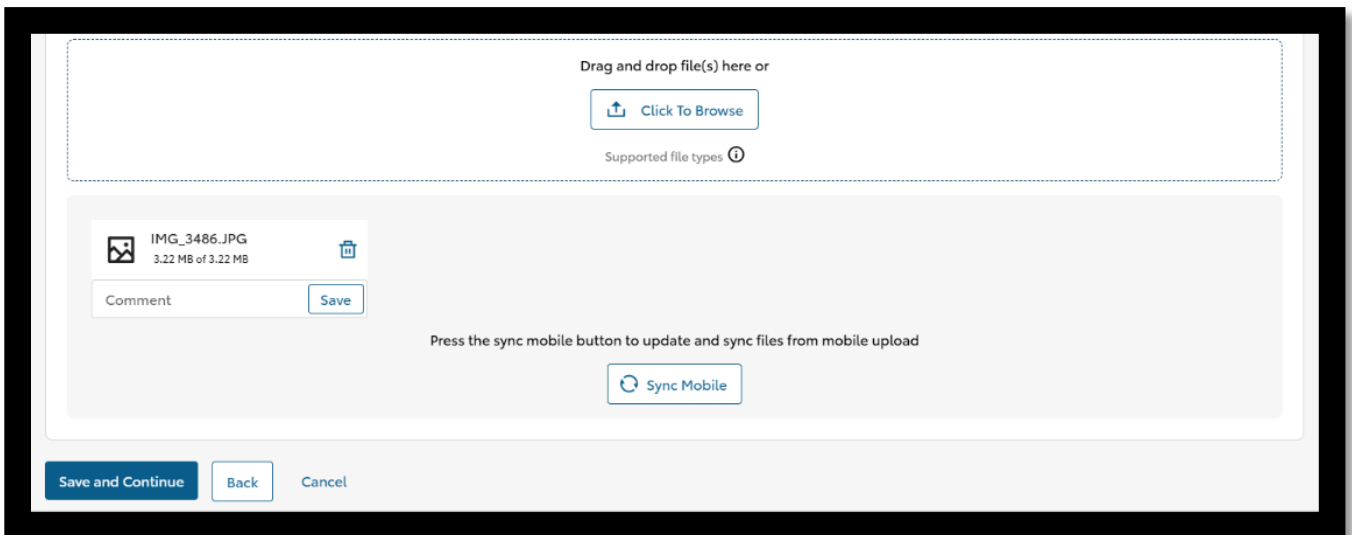
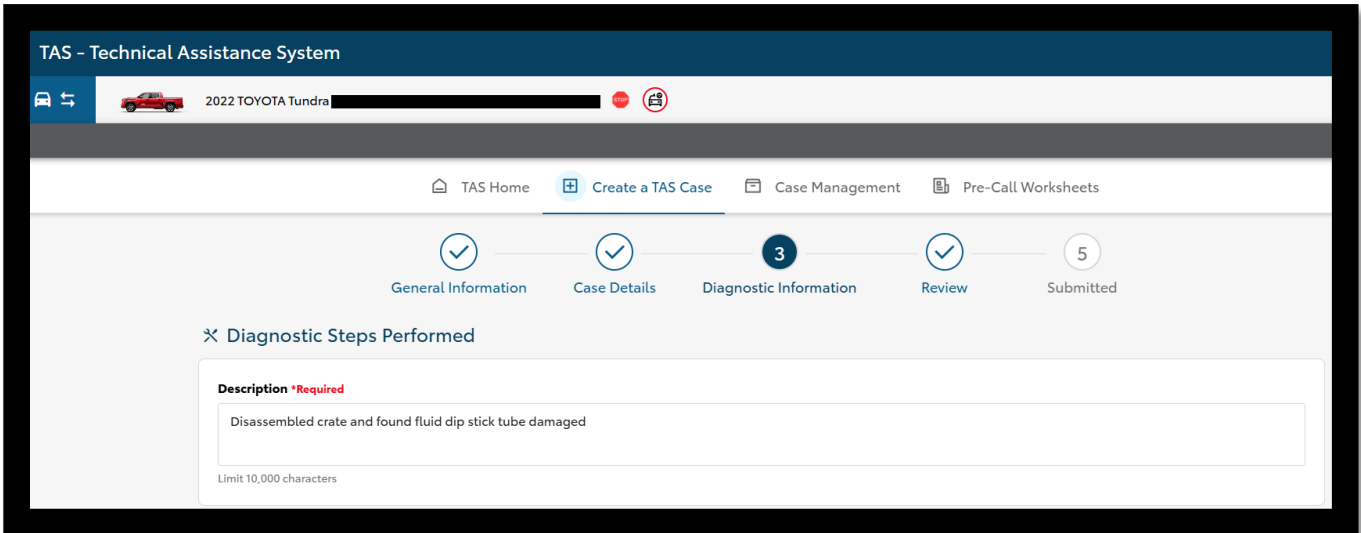

4. Review

- a. Confirm all details are correctly input
- b. Select "Submit"

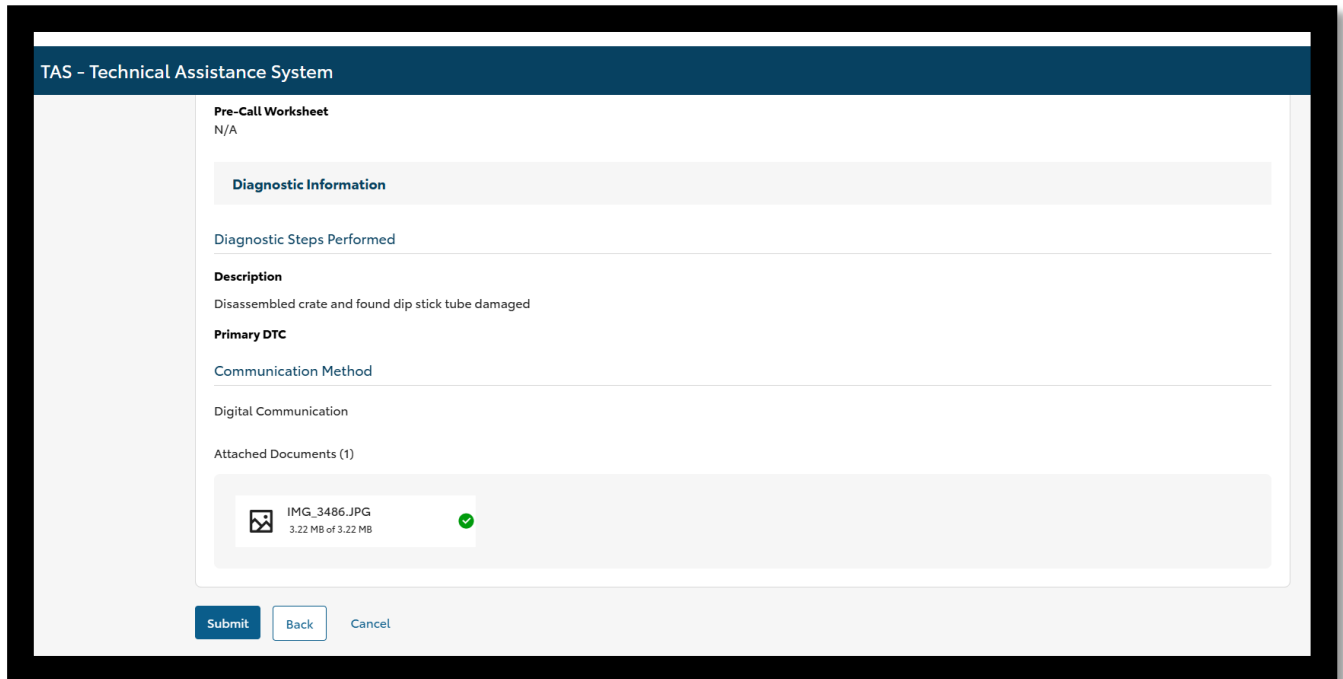

The screenshot displays the 'TAS - Technical Assistance System' interface. The form is titled 'Pre-Call Worksheet' and shows the following fields:

- Pre-Call Worksheet:** N/A
- Diagnostic Information:** A section header.
- Diagnostic Steps Performed:** A text input field.
- Description:** Disassembled crate and found dip stick tube damaged
- Primary DTC:** A text input field.
- Communication Method:** A text input field.
- Digital Communication:** A text input field.
- Attached Documents (1):** A list of attachments showing 'IMG_3486.JPG' (3.22 MB of 3.22 MB) with a green checkmark icon.

At the bottom of the form, there are three buttons: 'Submit' (highlighted in blue), 'Back', and 'Cancel'.

- Include a good call back number
- Attach clear pictures illustrating the damaged components
- Submit the TAS case.
- TAS will put the case in open status and forward the case to the FTS for review. Submit the completed case in TAS; allow 3 days for FTS to review the case. After 3 days, check the TAS case for status. If the repair is approved, the case will be marked closed. Additionally, the FTS will provide the necessary labor op-code as well as the maximum allowable time for the repairs requested.

NOTE: It is critical that dealers document all damaged components in the TAS case and attach pictures of the damaged components. TMNA will review all claims utilizing this special labor op-code to ensure the allowable time noted in the TAS case by the FTS matches the warranty claim filed by the dealer. (Include TAS case # on claim).

II. OPERATION FLOW CHART

The flow chart is for reference only. DO NOT use it in place of the full technical instructions. Follow ALL steps as outlined in the full technical instructions to confirm the campaign is completed correctly.

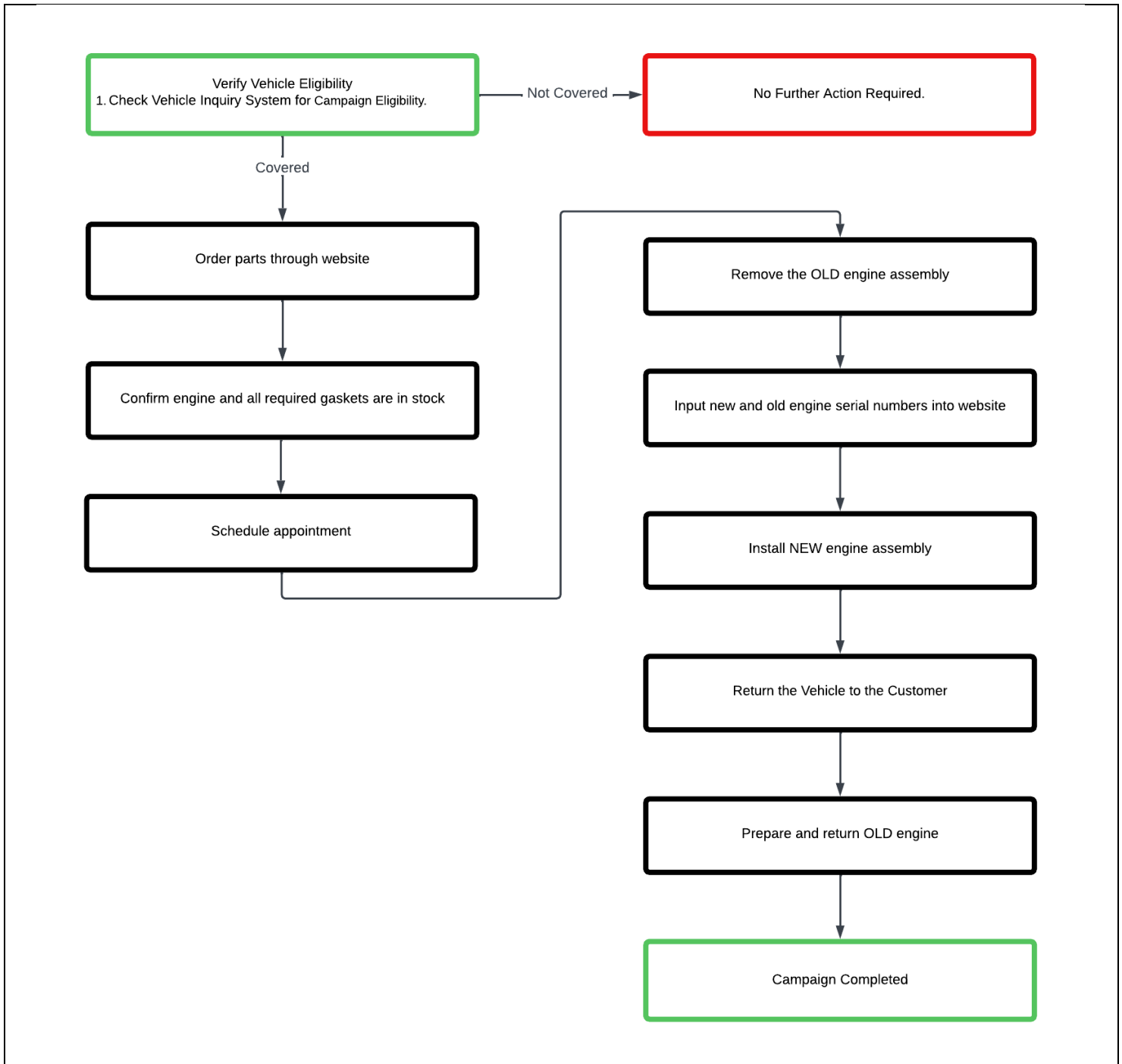

III. IDENTIFICATION OF AFFECTED VEHICLE

1. CHECK VEHICLE FOR CAMPAIGN ELIGIBILITY

- a. Compare the *vehicle's VIN to the* VIN listed on the Repair Order to ensure they match.
- b. Check the TIS Vehicle Inquiry System to confirm the VIN is involved in this Campaign, and that it has not already been completed.

NOTICE:

TMNA warranty will not reimburse dealers for repairs completed on vehicles that are not affected or were previously completed, even by another dealer.

IV. PREPARATION

NOTE: All parts in red will be ordered via the website.

A. PARTS

Part Number	Part Description	Quantity
04004-23170	Engine, Assy LX (Not returnable)	1
17279-0W040	Gasket, Turbine Outlet Elbow	2
00272-SLLC2	Genuine Toyota Super Long Life Coolant	5
00289-ATFWS	World Standard Automatic Transmission Fluid (If needed)	2
	0W20 Motor Oil - Genuine Lexus	Up to 8 quarts
04004-29160	Gasket Kit (SSP Kit)*	1

* The kit above includes the following parts

Part Number	Part Description	Quantity
16418-15520	PACKING, RADIATOR DRAIN	1
16418-70730	PACKING, RADIATOR DRAIN	1
17451-28041	GASKET, EXHAUST PIPE	2
17451-52050	GASKET, EXHAUST PIPE	1
17452-70010	CLAMP, EXHAUST PIPE	2
90099-14119	O-RING	2
90099-14120	O-RING	2
90099-14121	O-RING	1
90105-10590	BOLT, FLANGE	2
90430-12008	GASKET	1
90430-18008	GASKET	1
90467-08217	CLIP	4
90468-12023	CLIP	1
90917-06070	GASKET, EXHAUST PIPE	1



If used engine assembly is not returned according to the [job aid](#), the entire warranty claim amount is subject to debit. Ensure the used engine is returned following the engine return instructions.

TOOLS & EQUIPMENT

• GTS+	• Standard Hand Tools	• 1/2" Torque Wrench	• Pipe Insulator	• 3/8" Torque Wrench
• Bolts & nuts to secure chain on hook	• Chain (600+ lb weight rating)	• Small plastic bags	• Plywood or cardboard sheet to protect radiator	

Campaign SSTs: The following Campaign SSTs were shipped to your dealer prior to remedy launch of this recall and are required to be used for the remedy repair.

Image	Name	Quantity
	Norco Engine Hoist	1



NOTE: Confirm acme rod on engine hoist bottle jack is adjusted to about 1” (approximately 7 threads) to ensure engine hoist height requirement is met as shown above.

NOTE: Each dealer was provided one Norco High-Lift Engine Hoist at the launch of this recall. At the time of launch, this engine hoist **CANNOT** be ordered through the approved dealer equipment program. If an additional engine hoist is needed, and a dealer wishes to procure one at their own expense, please ensure engine hoist height from the hook to the ground is at least 91” or hoist will not be tall enough to complete repair.

NOTE: The engine hoist legs are longer than usual for additional stability. The vehicle may need to be backed into the stall or rolled backwards (if pulled in forward) depending on your shop space limitations to maneuver the engine hoist.

Service Hooks/Bolts: The following service hooks/bolts were shipped to your dealer prior to remedy launch of this recall and are required to be used for the remedy repair. These parts can be ordered through the dealer’s parts network.

Part Description	Part Number
Service Engine Hook No. 1	12281-70080
Service Engine Hook No. 2	12282-70050
Service Engine Hook Bolts	90105-A0354

V. BACKGROUND

There is a possibility that certain machining debris may not have been cleared from the engine when it was produced. In the involved vehicles, this can lead to potential engine knocking, engine rough running, engine no start and/or a loss of motive power. A loss of motive power while driving at higher speeds can increase the risk of a crash.

VI. COMPONENTS

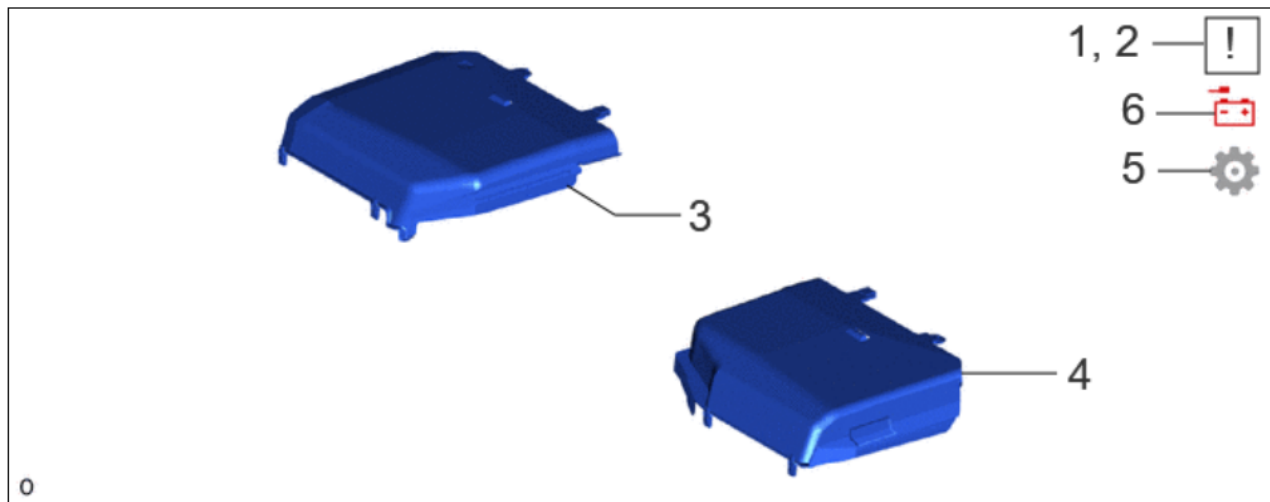

	PROCEDURE	PART NAME CODE
1	PRECAUTION	-
2	DISCHARGE FUEL SYSTEM PRESSURE	-
3	ENGINE SIDE COVER RH	51473C
4	ENGINE SIDE COVER LH	51474B
5	RELEASE PARKING BRAKE	-
6	DISCONNECT CABLE FROM NEGATIVE BATTERY TERMINAL	-

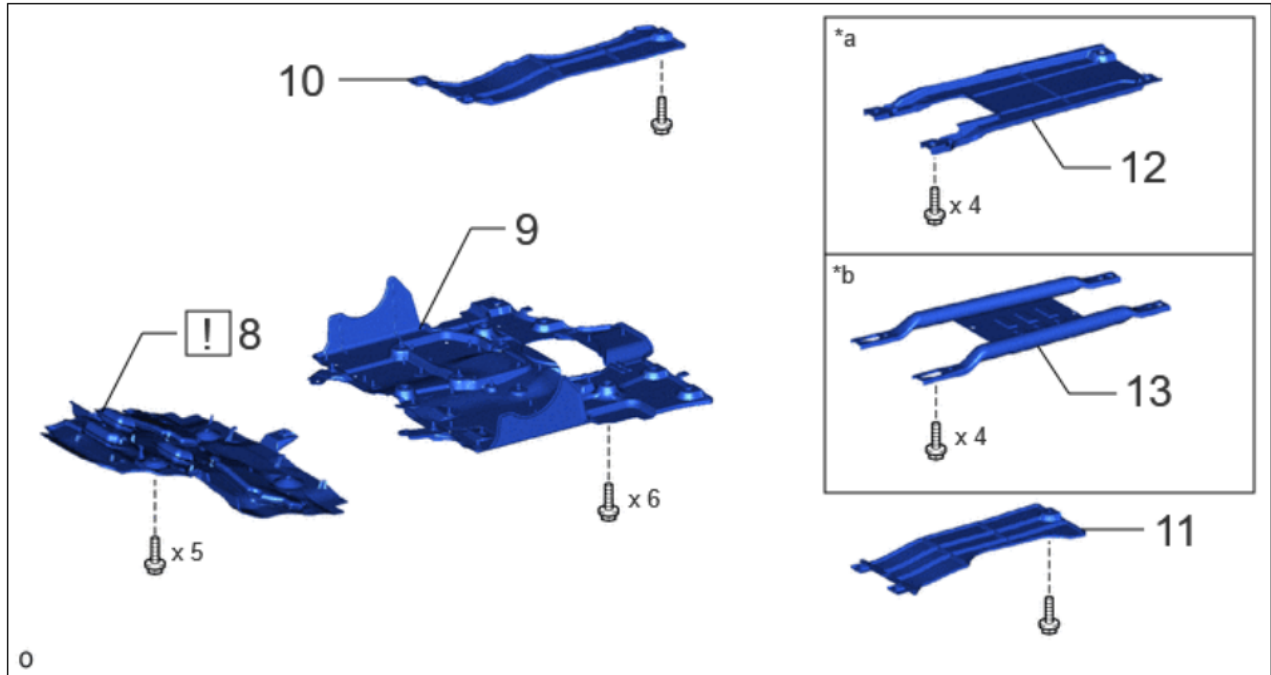

Procedure		Part Name Code
8	NO. 1 ENGINE UNDER COVER ASSEMBLY	51410
9	NO. 2 ENGINE UNDER COVER ASSEMBLY	51420
10	FRAME UNDER COVER ASSEMBLY RH	51430A
11	FRAME UNDER COVER ASSEMBLY LH	51450C
12	FRONT TRANSMISSION UNDER COVER ASSEMBLY	51460D
13	OIL PAN PROTECTOR ASSEMBLY	51440
*a	w/o Oil Pan Protector	*b w/ Oil Pan Protector

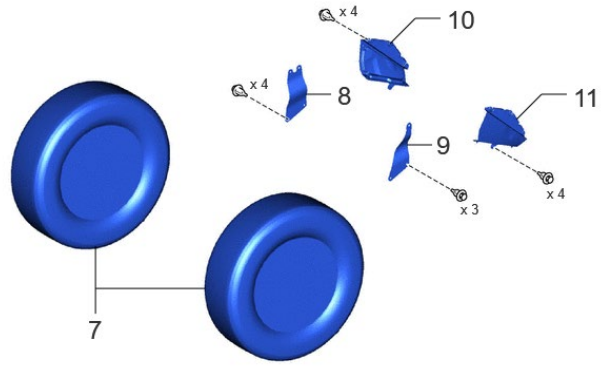

H

PROCEDURE		PART NAME CODE
7	FRONT WHEEL	-
8	FRONT FENDER APRON TRIM PACKING A	53782
9	FRONT FENDER APRON TRIM PACKING B	53783
1 0	FRONT FENDER APRON TRIM PACKING C	53784
1 1	FRONT FENDER APRON TRIM PACKING D	53785B

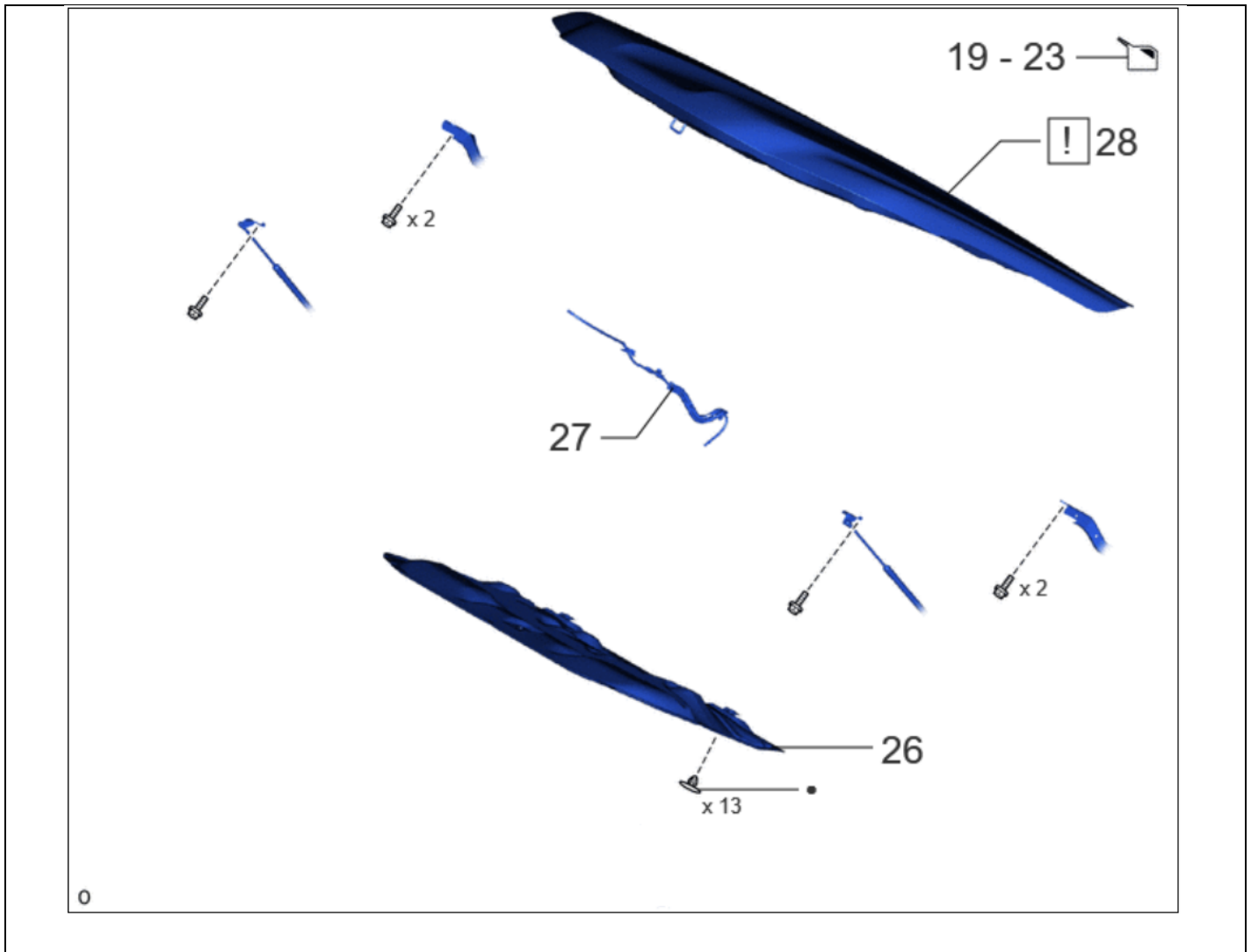

Procedure		Part Name Code
19	RECOVER REFRIGERANT FROM REFRIGERATION SYSTEM	-
20	DRAIN ENGINE OIL	-
21	DRAIN ENGINE COOLANT	-
22	DRAIN COOLANT (for Intercooler)	-
26	HOOD INSULATOR	53341B
27	WINDSHIELD WASHER HOSE ASSEMBLY	85370
28	HOOD SUB-ASSEMBLY	53301
•	Non-reusable part	

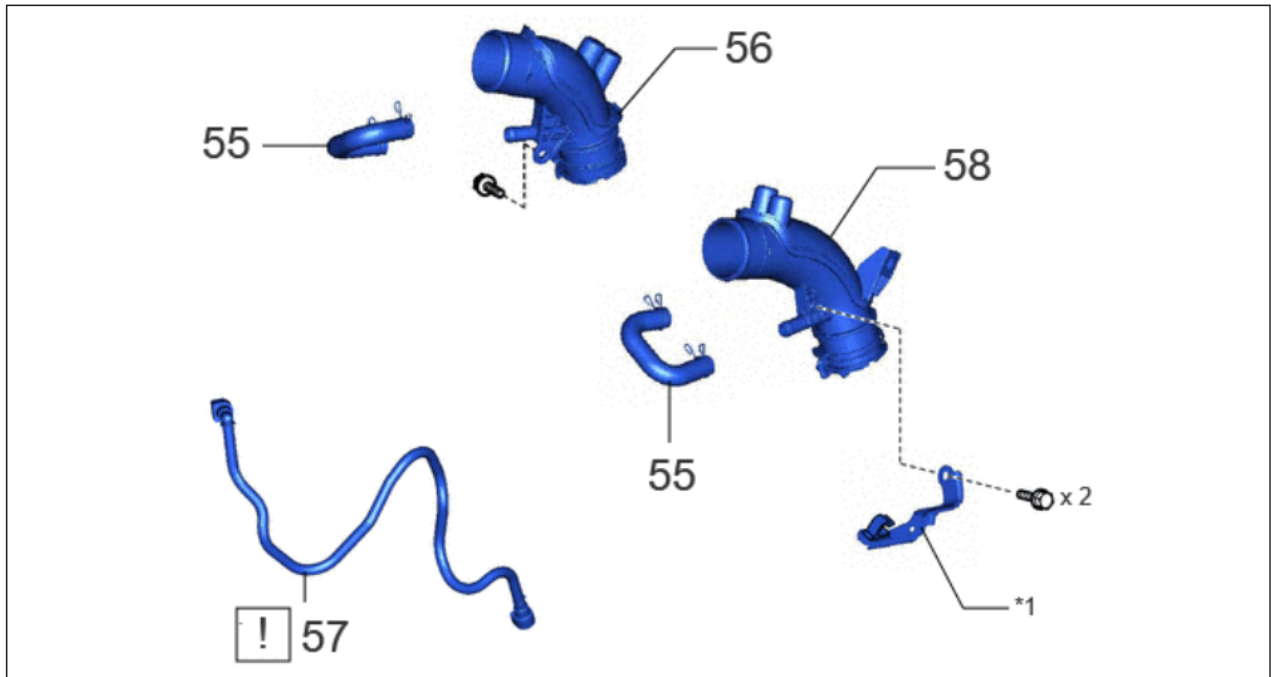

Procedure		Part Name Code
55	NO. 2 PCV HOSE (NO. 2 VENTILATION HOSE)	12262
56	NO. 1 AIR INLET DUCT	17311
57	FUEL TUBE SUB-ASSEMBLY	23901
58	NO. 2 AIR INLET DUCT	17312D
*1	COOL AIR INLET BRACKET	

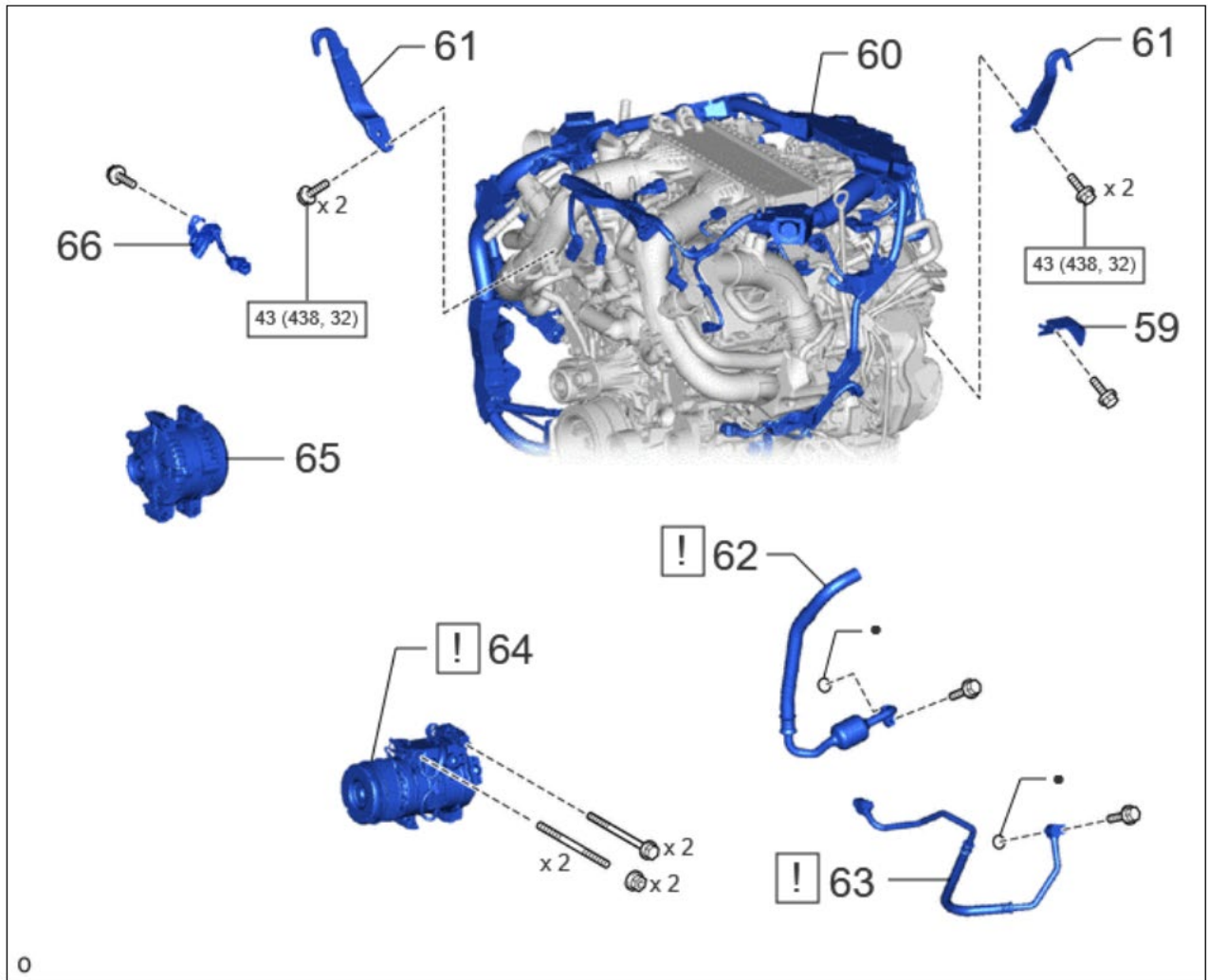

Procedure		Part Name Code
59	NO. 6 TURBO INSULATOR	1728C
60	ENGINE WIRE	82121
61	ENGINE HANGER	-
62	SUCTION HOSE SUB-ASSEMBLY	88704
63	NO. 1 COOLER REFRIGERANT DISCHARGE HOSE	88711
64	COMPRESSOR ASSEMBLY WITH MAGNET CLUTCH	-
65	GENERATOR ASSEMBLY	27020
66	NO. 10 ENGINE WIRE	8212B
<input type="checkbox"/>	N*m (kgf*cm, ft.*lbf): Specified torque	● Non-reusable part

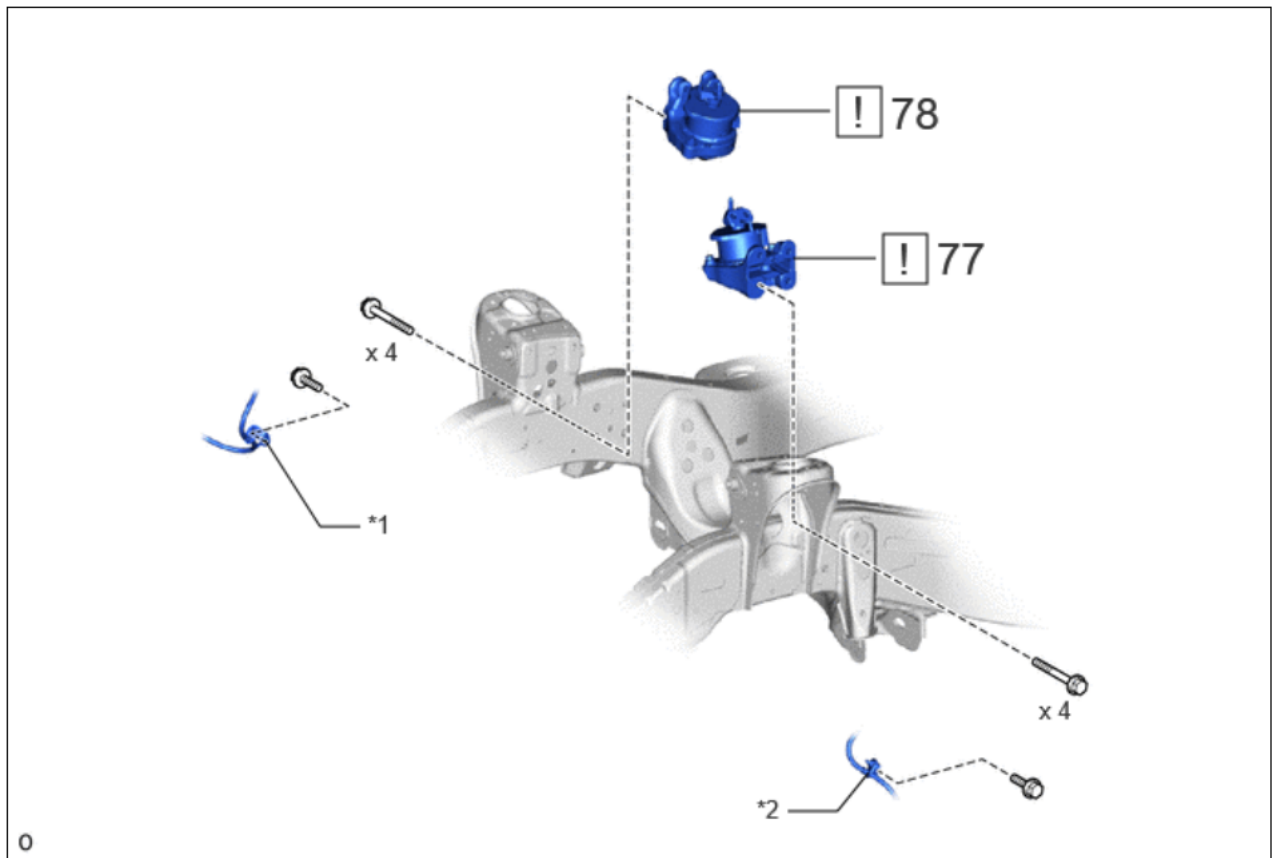

Procedure		Part Name Code	
77	FRONT ENGINE MOUNTING INSULATOR LH	12362A	
78	FRONT ENGINE MOUNTING INSULATOR RH	12361E	
*1	FRONT NO. 2 FLEXIBLE HOSE BRACKET RH	*2	FRONT NO. 2 FLEXIBLE HOSE BRACKET LH

VII.

1. Ensure engine is ordered using instructions in [24LA04 Dealer Letter](#).
2. Engine Crate Disassembly



Engine Crate will be reused to return the OLD engine, so **DO NOT** damage the crate/box or the plastic bag inside the crate.

- a. Carefully cut the side of each strap with the shortest flap on the outside of the crate as shown below

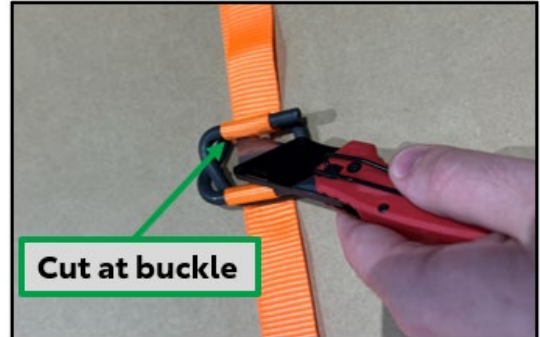
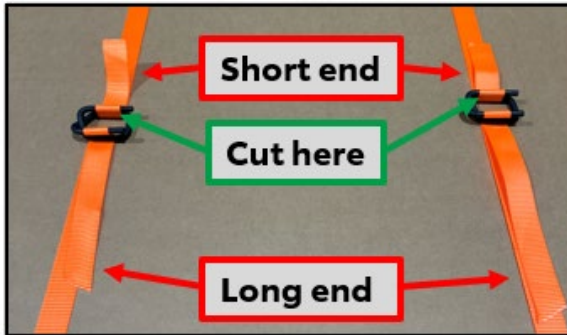

Do not discard straps or buckles as they are required for engine recovery.

3. Engine Assembly 04004-23170 Overview

While the **NEW** engine assembly contains most components such as intercooler, turbos, and fuel system, some components will need to be transferred from the existing engine to the replacement engine such as:

- Starter
- Engine Wire Harness
- Alternator
- A/C Compressor
- Drive belt tensioner
- Drive belts

See pictures below for reference of engine assembly.

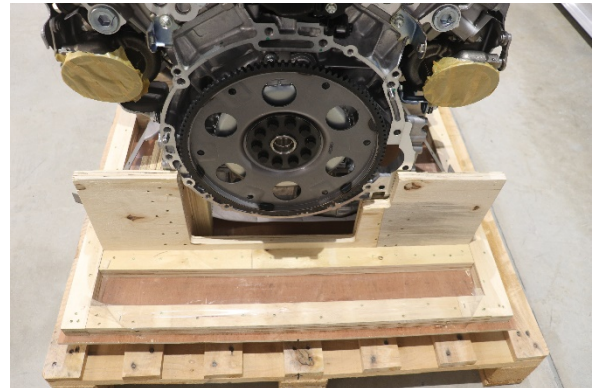

VI. REPAIR INSTRUCTIONS



Only complete the following repair procedure after completing steps above.

1. REMOVE THE ENGINE ASSEMBLY

NOTICE:

Carefully read the cautions written in the repair manual and perform the written instructions correctly.



IF ENGINE IS SEIZED (CANNOT BE TURNED OVER BY HAND) SEE STEP 84 OF THIS SECTION.

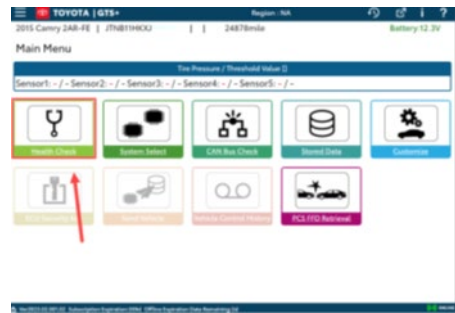

1. CHECK FOR DTCS

- a. Using a Techstream/GTS+, check for Diagnostic Trouble Codes.

NOTICE:

This Safety Recall only covers the engine replacement. It does not cover the diagnosis or replacement of any other systems on the vehicle.

2. REMOVE ENGINE SIDE COVER RH

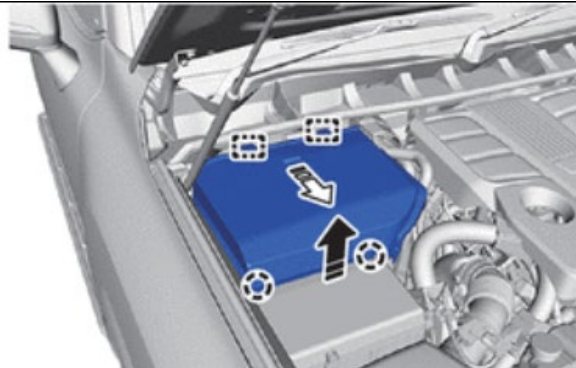

	Remove in this Direction (1)		Remove in this Direction (2)
--	------------------------------	--	------------------------------

3. REMOVE ENGINE SIDE COVER LH

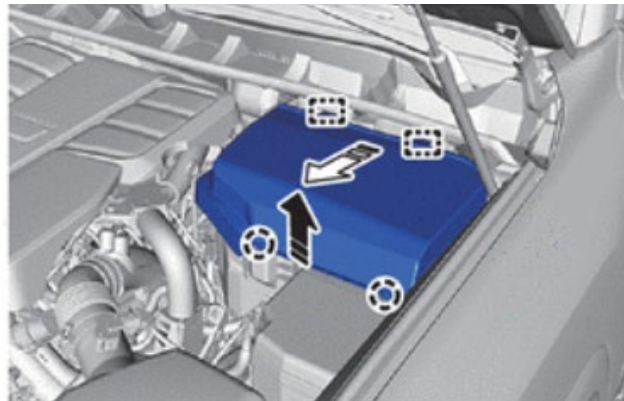

	Remove in this Direction (1)		Remove in this Direction (2)
--	------------------------------	--	------------------------------

4. DISABLE PARKING BRAKE and DISCHARGE FUEL PRESSURE

- a. Turn the ignition ON (key on, engine off).
- b. Depress brake pedal
- c. Press the electric parking brake switch on the center console to release the brake
- d. Check that the parking brake indicator light on the combination meter turns off
- e. Remove the EFI-MAIN No. 2 relay.
- f. Loosen or remove the fuel tank cap assembly.
- g. Start the engine and slightly depress the accelerator pedal (50% or more).
- h. Keep accelerator applied until engine stops running
- i. Turn the ignition switch OFF
- j. Install fuel cap
- k. Install EFI-MAIN No.2 Relay.

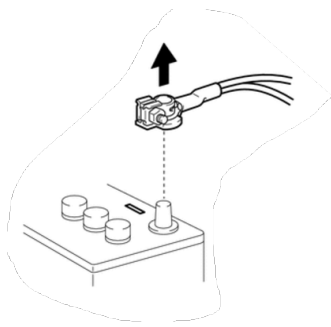

5. DISCONNECT CABLE FROM NEGATIVE BATTERY TERMINAL

6. RECOVER REFRIGERANT FROM REFRIGERATION SYSTEM

Recover the refrigerant from the A/C system using a refrigerant recovery unit.

7. REMOVE NO. 1 ENGINE UNDER COVER ASSEMBLY

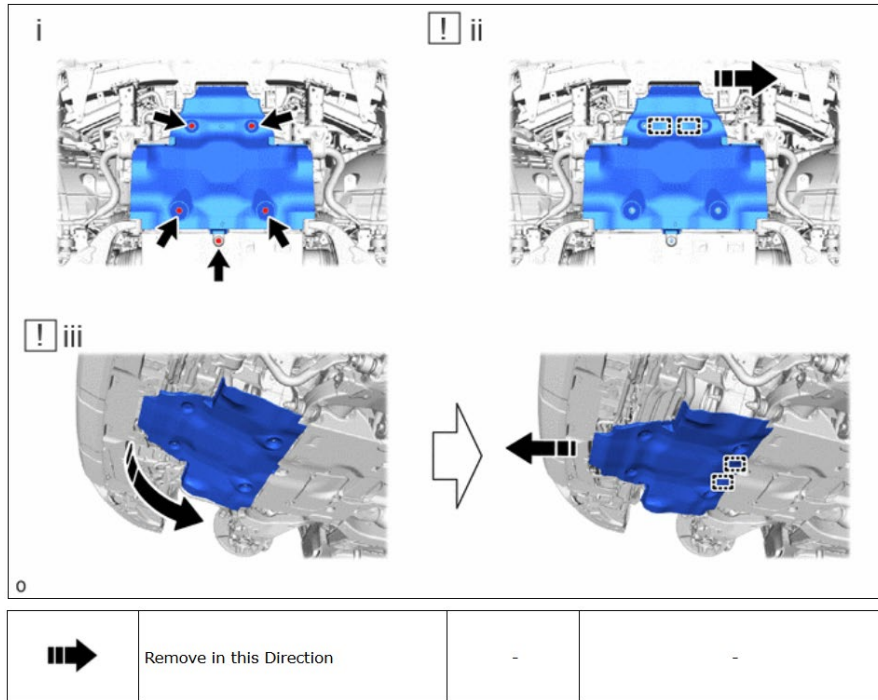

- Remove the 5 bolts.
- Move the side of the No. 1 engine under cover assembly facing the front of the vehicle toward the LH side and detach the temporary holding guide.
- Remove the No. 1 engine under cover assembly while detaching the 2 temporary holding guides of the No. 1 engine under cover assembly as shown in the illustration.

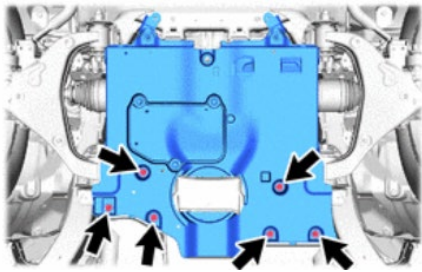

8. REMOVE NO. 2 ENGINE UNDER COVER ASSEMBLY

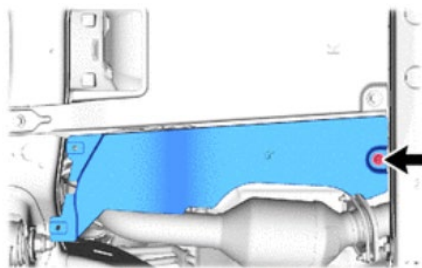

9. REMOVE FRAME UNDER COVER ASSEMBLY RH

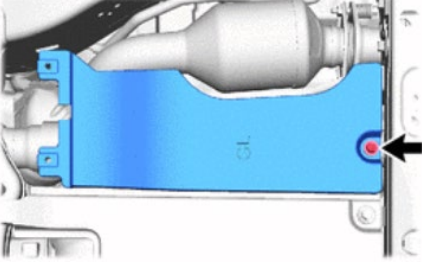
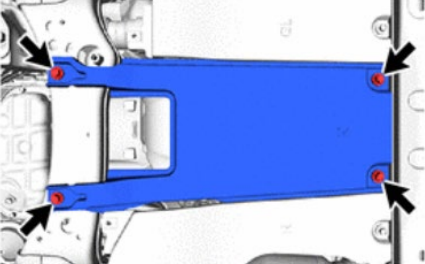
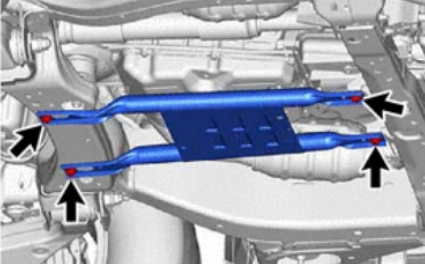
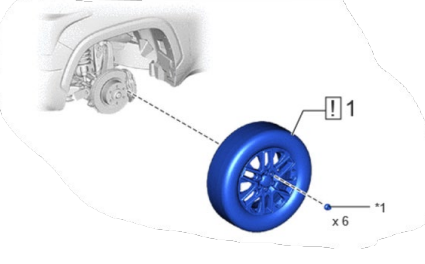
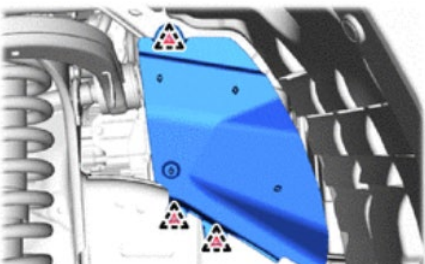
	<p>10. REMOVE FRAME UNDER COVER ASSEMBLY LH</p>
	<p>11. REMOVE FRONT TRANSMISSION UNDER COVER ASSEMBLY (w/o Oil Pan Protector)</p>
	<p>12. REMOVE OIL PAN PROTECTOR ASSEMBLY (w/ Oil Pan Protector)</p>
	<p>13. REMOVE FRONT WHEEL a. Remove the 6 lug nuts and remove front wheel b. Repeat on other side</p>
	<p>14. REMOVE FRONT FENDER APRON TRIM PACKING A</p>

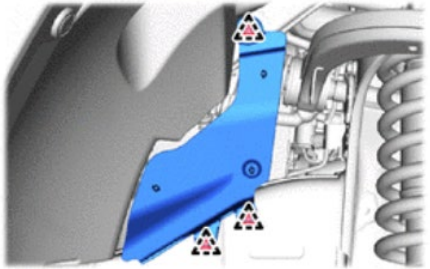
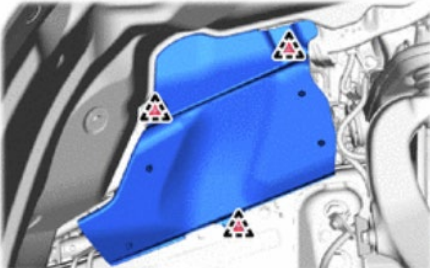
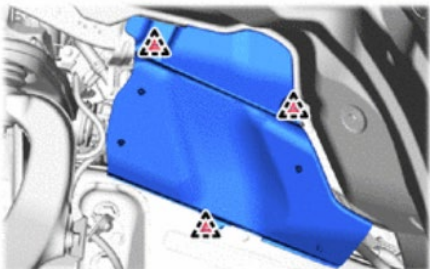
	<p>15. REMOVE FRONT FENDER APRON TRIM PACKING B</p>
	<p>16. REMOVE FRONT FENDER APRON TRIM PACKING C</p>
	<p>17. REMOVE FRONT FENDER APRON TRIM PACKING D</p>
<p>18. DRAIN ENGINE OIL</p> <ol style="list-style-type: none"> a. Remove drain plug and drain engine oil. b. Reinstall drain plug after empty. 	
<p>19. DRAIN ENGINE COOLANT</p> <ol style="list-style-type: none"> a. Connect a hose with an inside diameter of 9 mm (0.354 in.) to the radiator drain cock as shown in the illustration. b. Connect a hose with an inside diameter of 8 mm (0.315 in.) to the cylinder block water drain cock plug as shown in the illustration. c. Loosen the radiator drain cock plug d. Remove the reserve tank cap. Then drain the engine coolant e. Loosen the cylinder block water drain cock plug f. Tighten the cylinder block water drain cock plug. Torque: 	

12.7 N·m {130 kgf·cm, 9 ft·lbf}

- g. Tighten the radiator drain cock plug by hand
- h. Disconnect the hose from the cylinder block water drain cock plug
- i. Disconnect the hose from the radiator drain cock

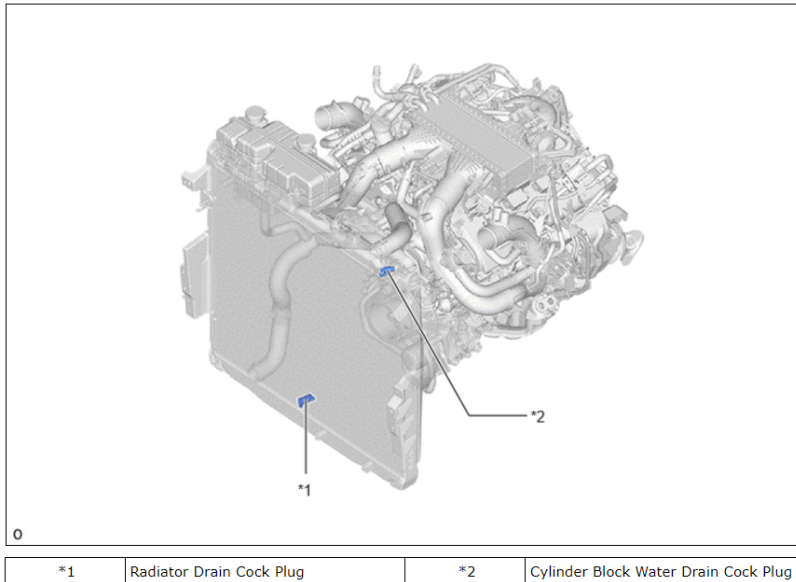

20. DRAIN ENGINE COOLANT (FOR INTERCOOLER)

- a. Connect a hose with an inside diameter of 8 mm (0.315 in.) to the radiator drain cock sub-assembly
- b. Loosen the radiator drain cock sub-assembly (for Intercooler) and drain the coolant
- c. Tighten the radiator drain cock sub-assembly (for Intercooler) by hand after empty

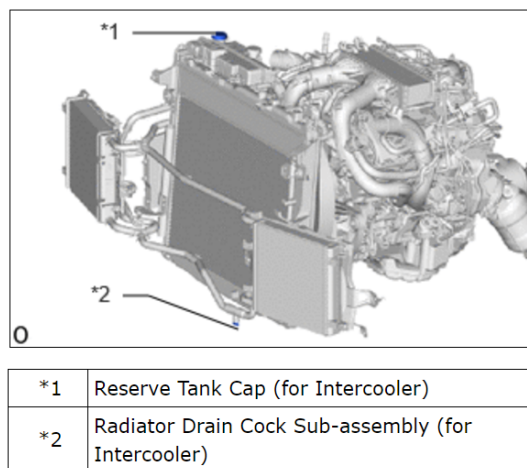

21. REMOVE UPPER RADIATOR SUPPORT SEAL

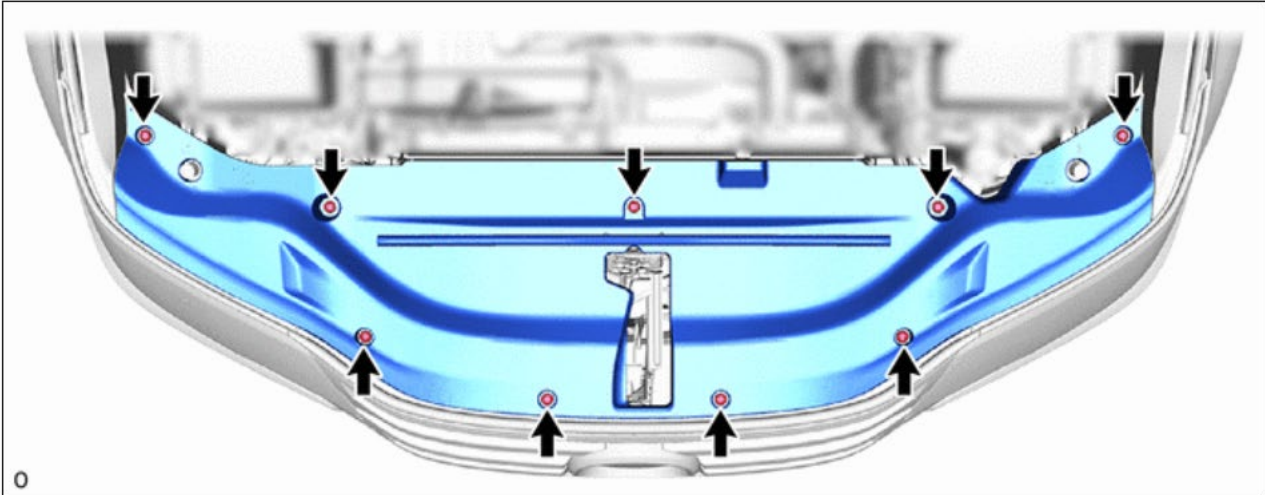

22. REMOVE V-BANK COVER SUB-ASSEMBLY

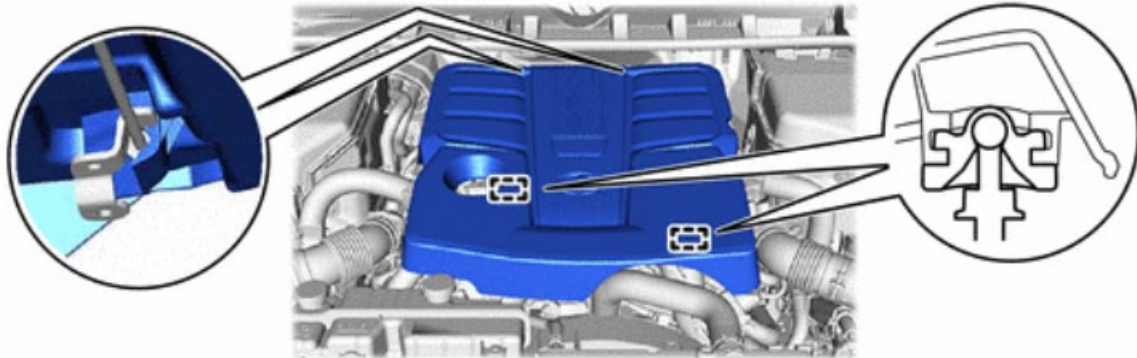

23. REMOVE HOOD INSULATOR

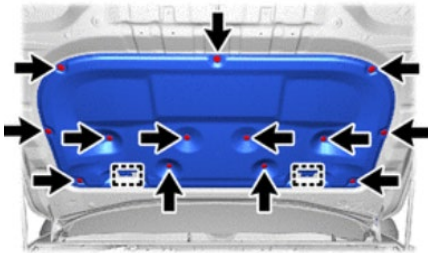

24. DISCONNECT WINDSHIELD WASHER HOSE ASSEMBLY

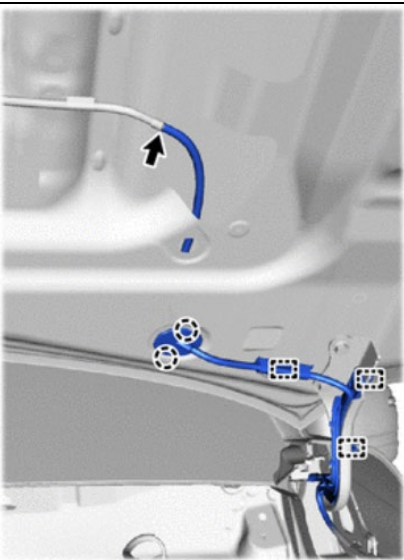

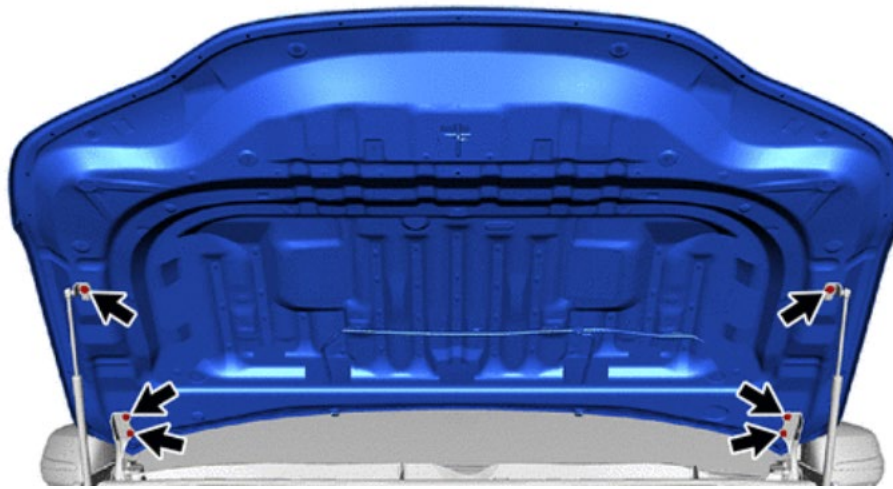

25. REMOVE HOOD SUB-ASSEMBLY



NOTE: Be sure to perform this procedure with several people as the hood sub-assembly is very heavy.

26. REMOVE FRONT WIPER ARM HEAD CAP



	Remove in this Direction		Protective Tape
---	--------------------------	---	-----------------

a. Using a screwdriver with its tip wrapped with protective tape, disengage the claw as shown in the illustration to remove the front wiper arm head cap.

NOTE: Use the same procedure for the RH and LH sides. The procedure described below is for the LH side.

27. REMOVE FRONT WIPER ARM AND BLADE ASSEMBLY LH and RH

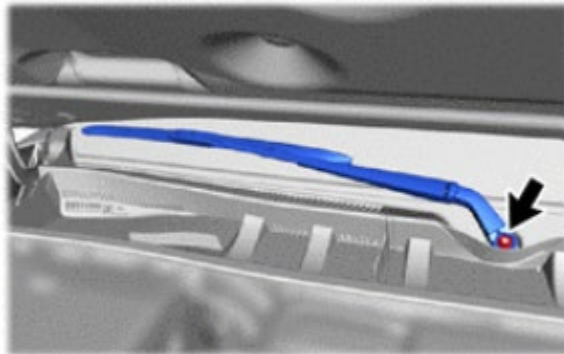



- Remove the nut and front wiper arm and blade assembly RH.
- Remove the nut and the front wiper arm and blade assembly LH.

NOTE: While holding the front wiper arm and blade assembly RH, loosen the nut.

NOTE: While holding the front wiper arm and blade assembly LH, loosen the nut.

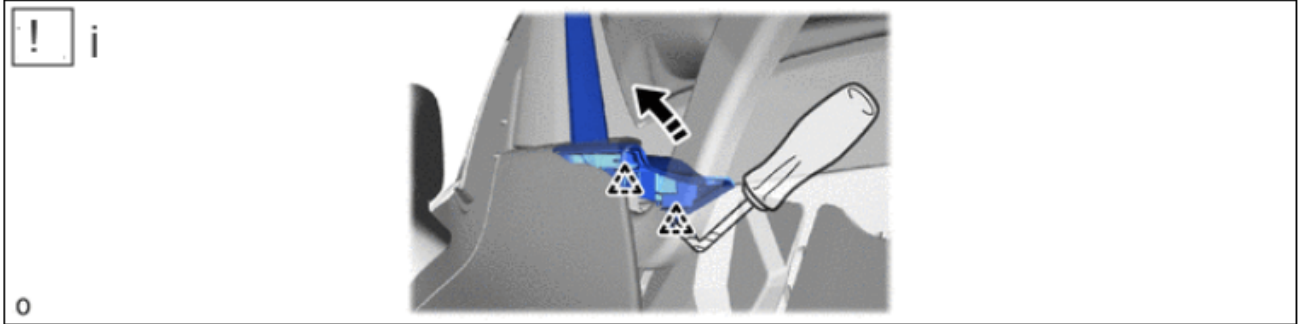
28. REMOVE WINDSHIELD OUTSIDE MOULDING RH



	Remove in this Direction		Protective Tape
---	--------------------------	---	-----------------

- a. Using a clip remover with its tip wrapped with protective tape, detach the clip and remove the windshield outside moulding RH.

29. REMOVE WINDSHIELD OUTSIDE MOULDING LH

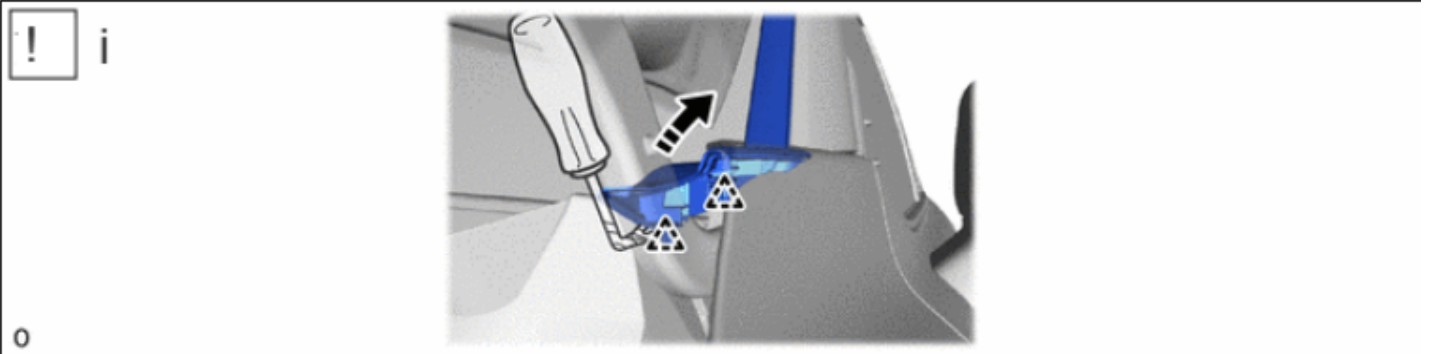

	Remove in this Direction		Protective Tape
---	--------------------------	---	-----------------

- a. Using a clip remover with its tip wrapped with protective tape, detach the clip and remove the windshield outside moulding LH.

30. REMOVE HOOD TO COWL TOP SEAL

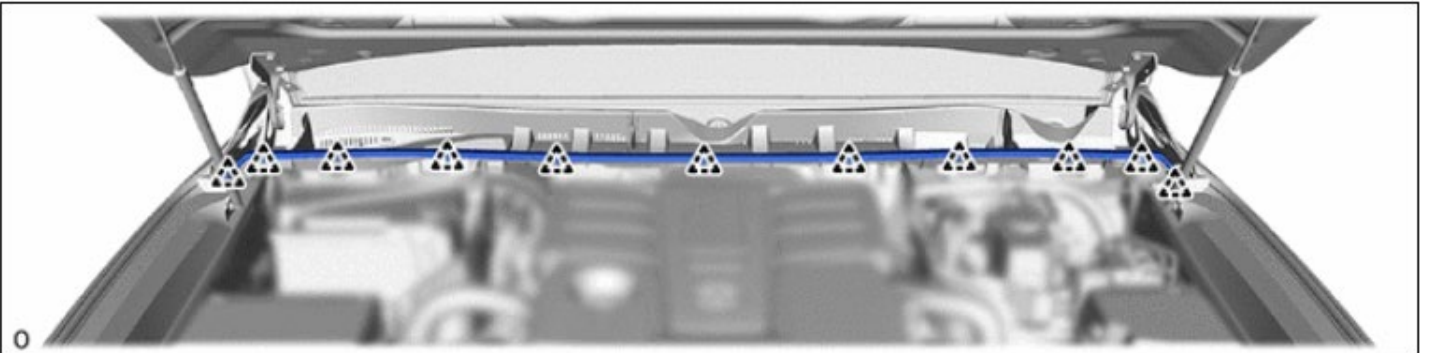

31. REMOVE COWL TOP VENTILATOR LOUVER RH

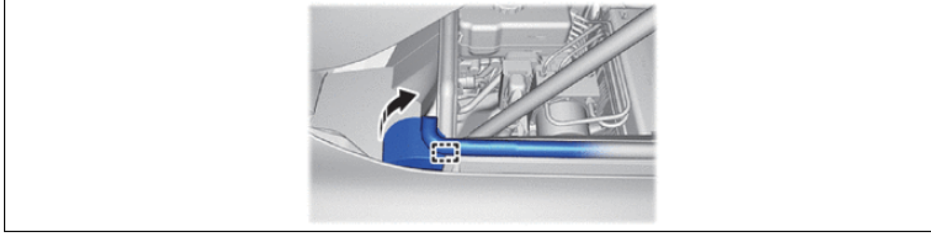

	Remove in this Direction (1)	-	-
--	------------------------------	---	---

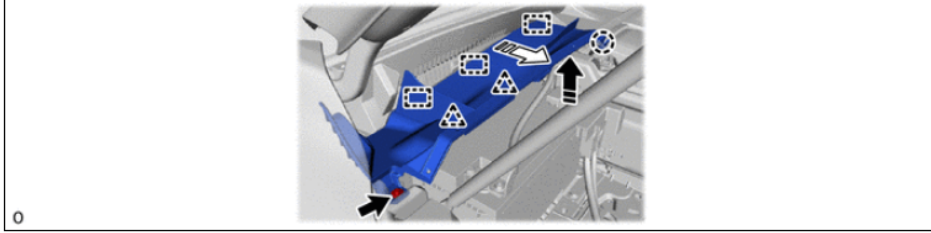

	Remove in this Direction (1)		Remove in this Direction (2)
--	------------------------------	--	------------------------------

32. REMOVE COWL TOP VENTILATOR LOUVER LH

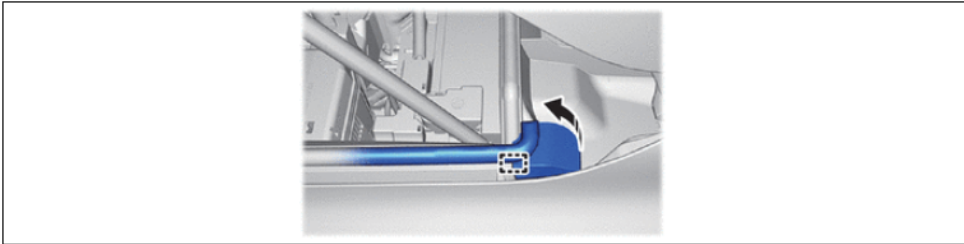

	Remove in this Direction (1)	-	-
--	------------------------------	---	---

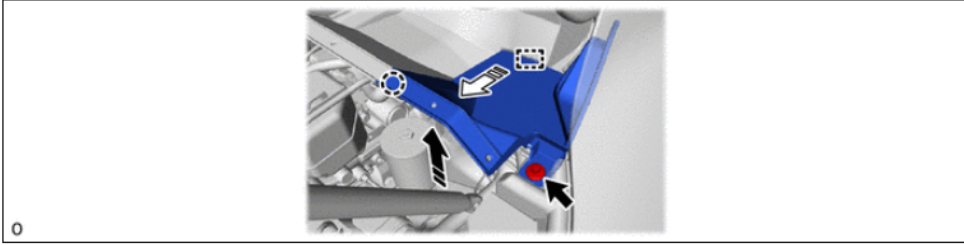

	Remove in this Direction (1)		Remove in this Direction (2)
--	------------------------------	--	------------------------------

33. REMOVE COWL TOP VENTILATOR LOUVER SUB-ASSEMBLY

NOTE: To prevent damage to the windshield glass, remove any foreign matter (sand, dust, etc.) from around the contacting surfaces of the cowl top ventilator louver sub-assembly and windshield glass.

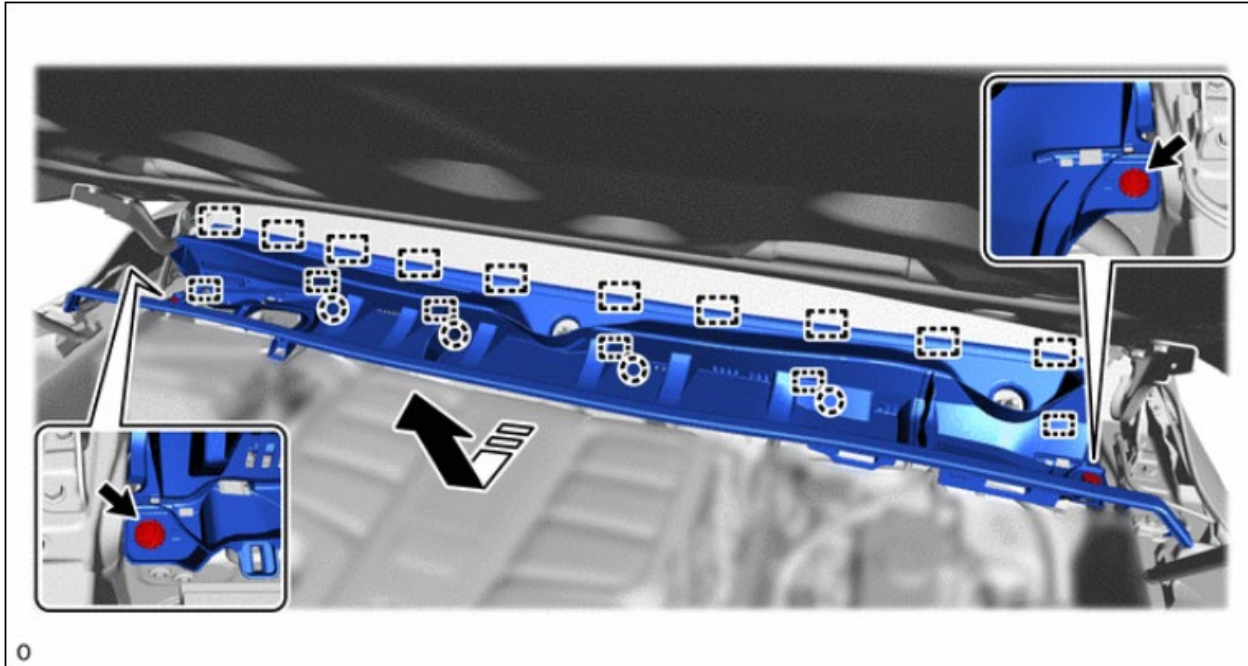

	Remove in this Direction	-	-
--	--------------------------	---	---

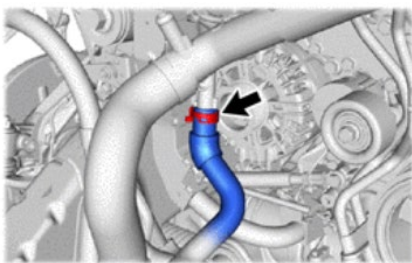

34. DISCONNECT NO. 3 WATER BY-PASS HOSE

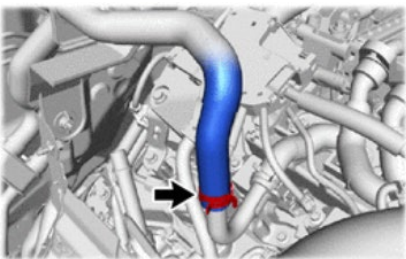

35. DISCONNECT OUTLET HEATER WATER HOSE

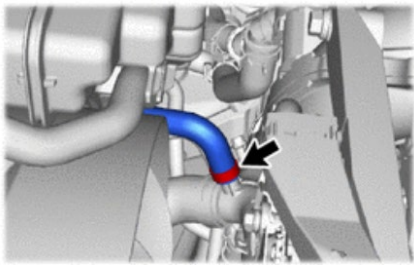

36. DISCONNECT NO. 2 WATER BY-PASS HOSE

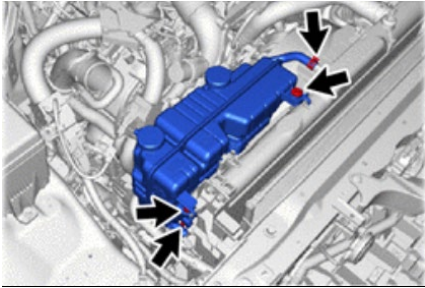

37. REMOVE RADIATOR RESERVE TANK ASSEMBLY

38. DISCONNECT ENGINE COOLANT TEMPERATURE SENSOR

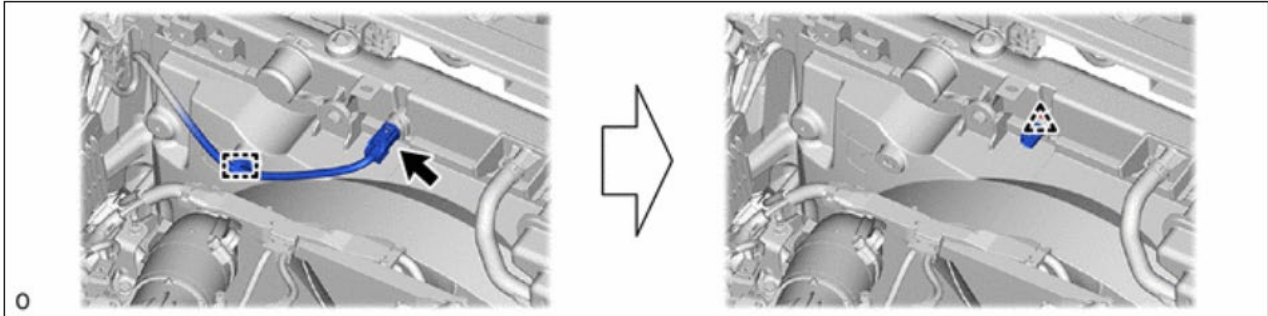

NOTE: If the engine coolant temperature sensor has been struck or dropped, replace it.

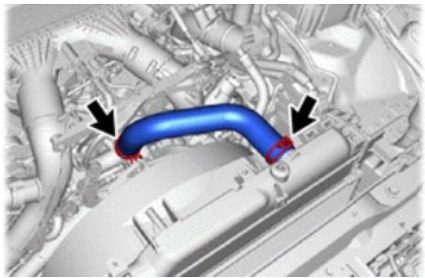

39. REMOVE NO. 1 RADIATOR HOSE

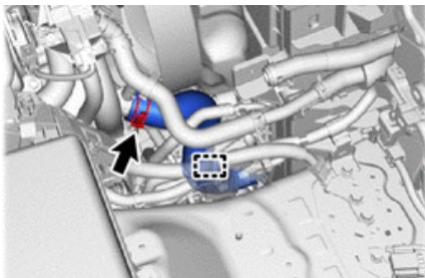

40. DISCONNECT NO. 2 RADIATOR HOSE

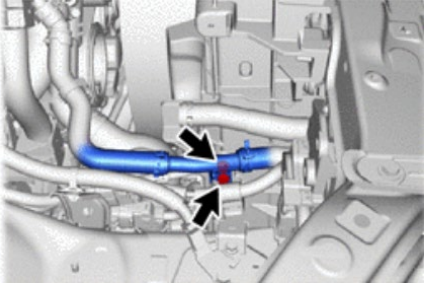
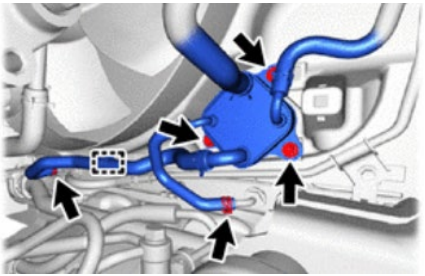
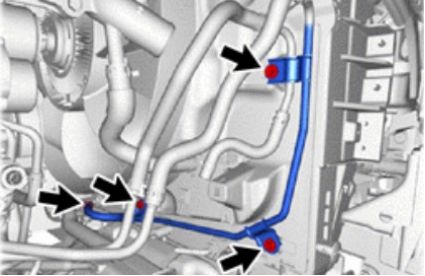
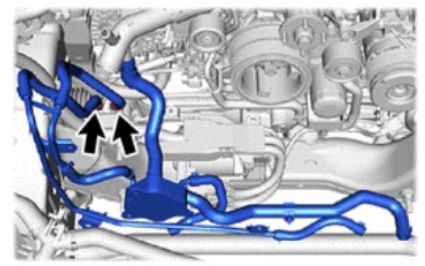
	<p>41. DISCONNECT NO. 2 WATER BY-PASS PIPE</p>
	<p>42. DISCONNECT OIL COOLER ASSEMBLY WITH OIL COOLER HOSE</p>
	<p>43. DISCONNECT OIL COOLER TUBE SUB-ASSEMBLY</p>
	<p>44. REMOVE OIL COOLER TUBE AND OIL COOLER HOSE WITH OIL COOLER ASSEMBLY</p>

45. REMOVE AIR CLEANER ASSEMBLY RH WITH AIR CLEANER HOSE ASSEMBLY RH

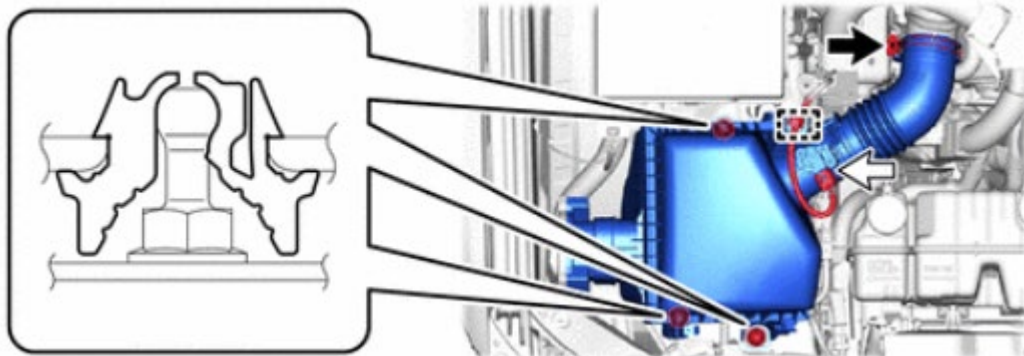

46. REMOVE AIR CLEANER ASSEMBLY LH WITH AIR CLEANER HOSE ASSEMBLY LH

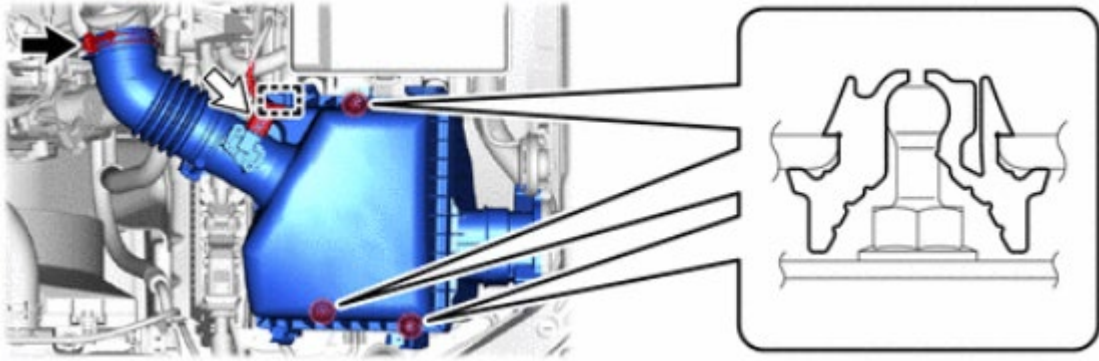

47. REMOVE UPPER ENGINE SIDE UNDER COVER PLATE LH

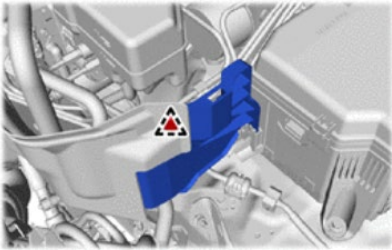

48. REMOVE REAR ENGINE SIDE UNDER COVER ASSEMBLY LH

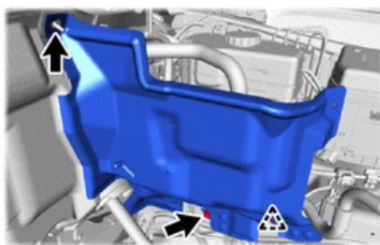

49. REMOVE ENGINE SIDE UNDER COVER RH

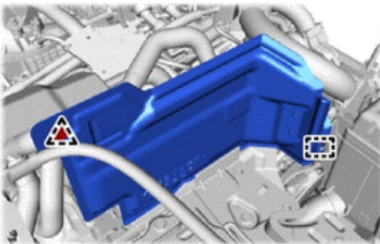

50. REMOVE BATTERY AND BATTERY CARRIER ASSEMBLY

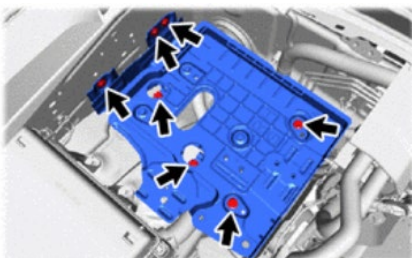

51. DISCONNECT ECM CONNECTOR

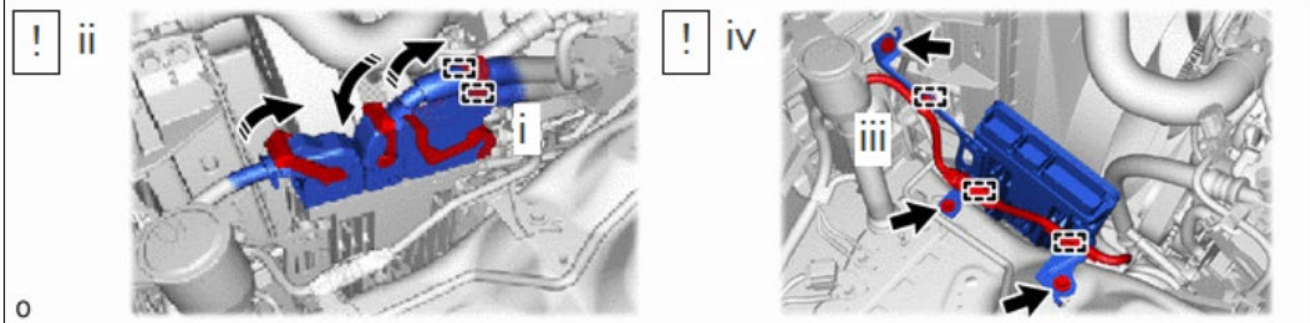

- a. Detach the 2 wire connector clamps.
- b. Push in the locks on the 3 levers, raise the 3 levers, and disconnect the 3 ECM connectors.

NOTE: After disconnecting the ECM connectors, make sure that dirt, water and other foreign matter does not contact the connecting parts of the ECM connectors.

- c. Detach the 3 wire harness clamps.
- d. Remove the 3 bolts and ECM.

NOTE: If the ECM has been struck or dropped, replace it.

52. DISCONNECT ENGINE WIRE

NOTE: After disconnecting the wire harness, secure it with tape or equivalent to keep it out of the way.

*A

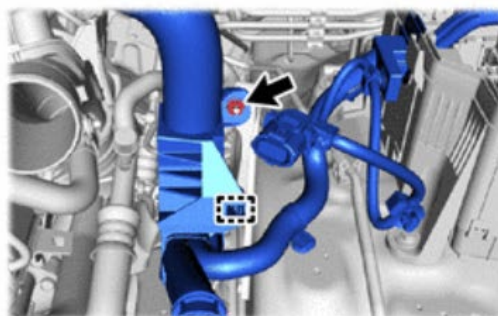
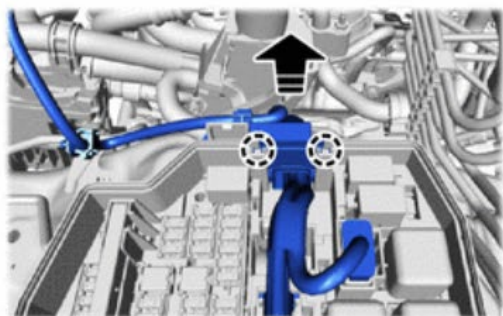
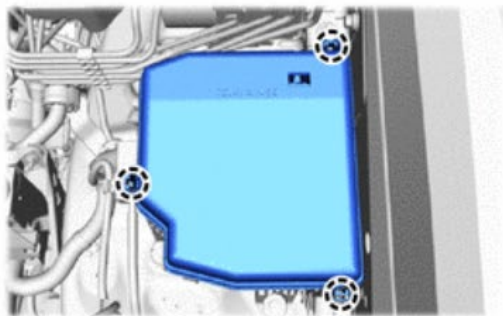

0

*A	for LH Side	-	-
	Remove in this Direction	-	-

*A

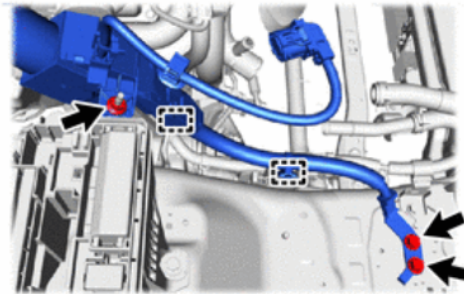
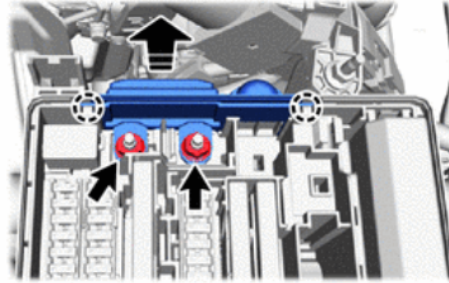
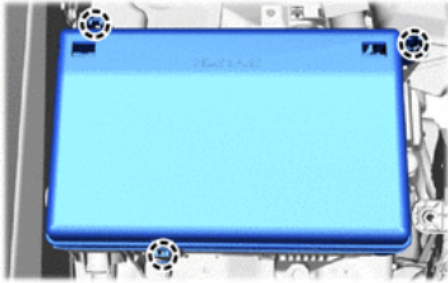

0

*A	for RH Side	-	-
	Remove in this Direction	-	-

53. DISCONNECT FUEL TUBE SUB-ASSEMBLY

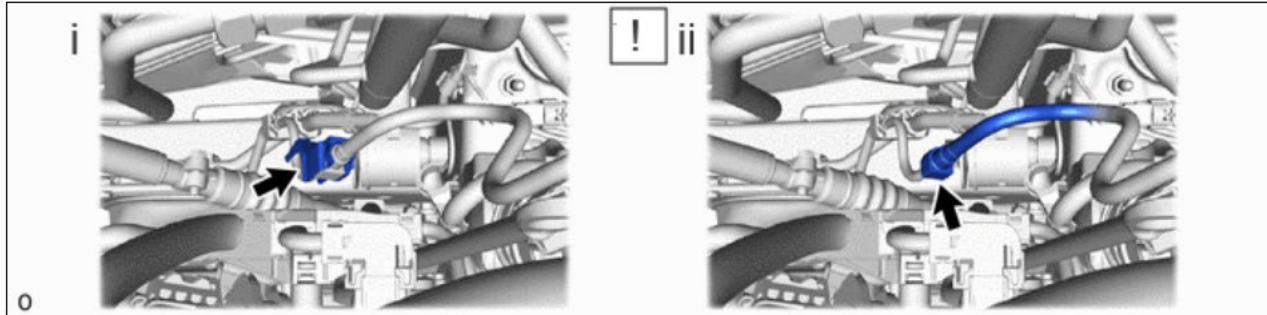

- a. Remove the fuel pipe clamp from the fuel tube connector.
- b. Disconnect the fuel tube sub-assembly.

54. REMOVE NO. 2 PCV HOSE

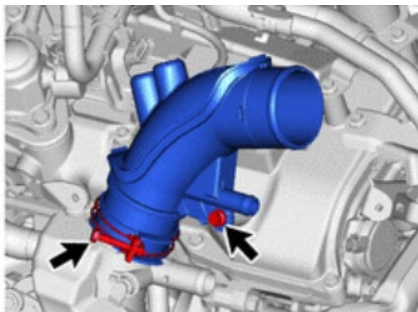
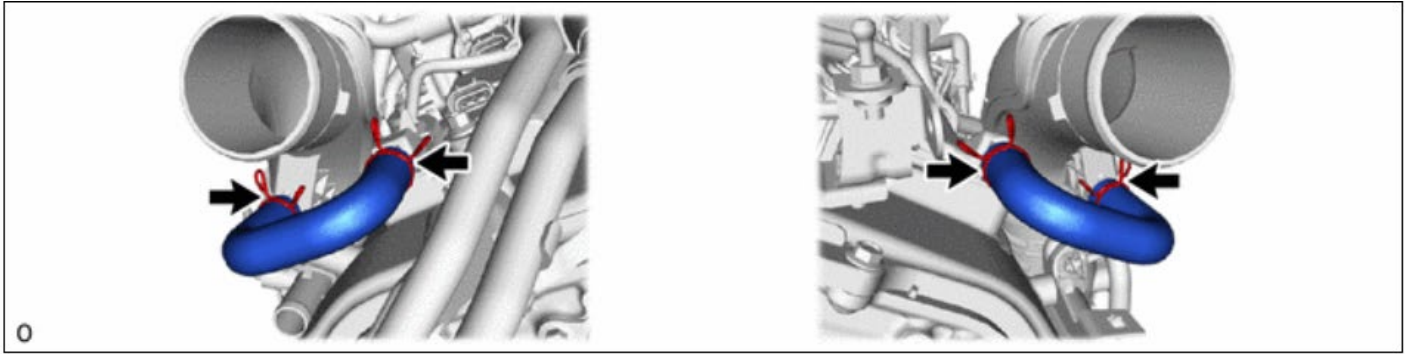

55. REMOVE NO. 1 AIR INLET DUCT

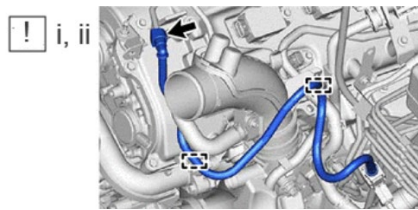

56. REMOVE FUEL TUBE SUB-ASSEMBLY

- a. Disconnect the fuel tube sub-assembly.
- b. Detach the 2 clamps and remove the fuel tube sub-assembly.

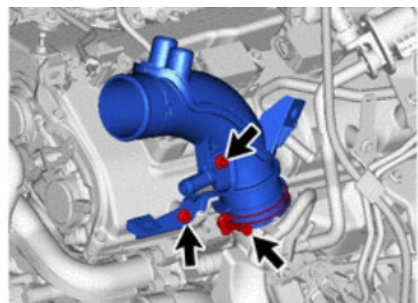

57. REMOVE NO. 2 AIR INLET DUCT

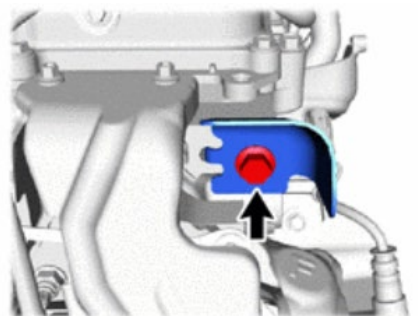

58. REMOVE NO. 6 TURBO INSULATOR

59. DISCONNECT ENGINE WIRE

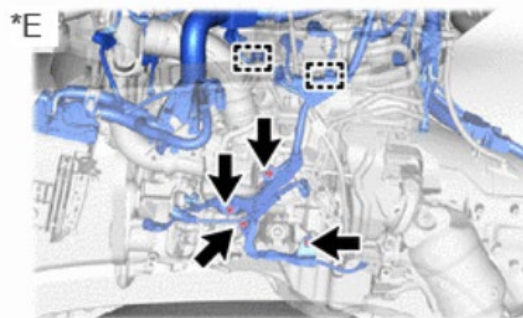
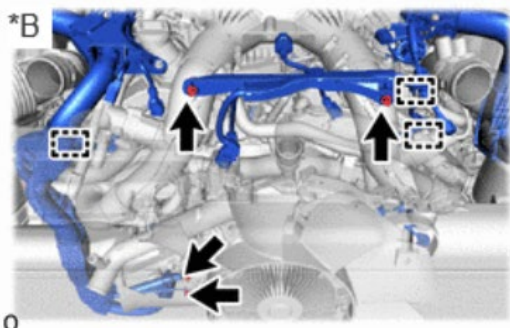
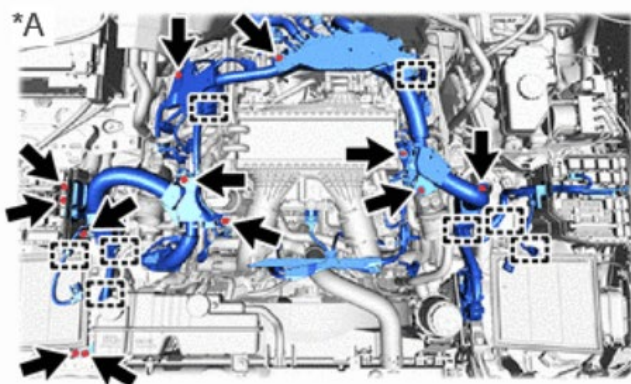
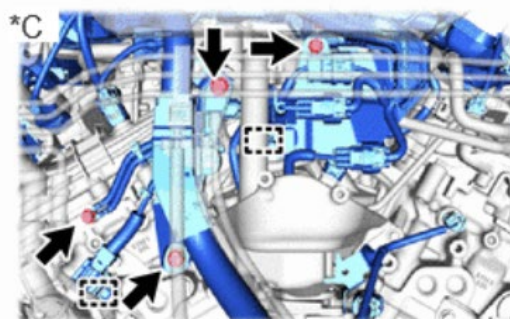
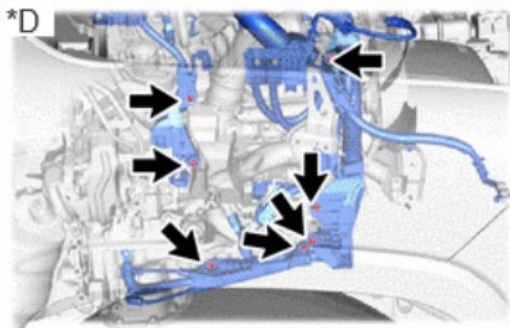

*A	for Upper Side	*B	for Front Side
*C	for Rear Side	*D	for RH Side
*E	for LH Side	-	-

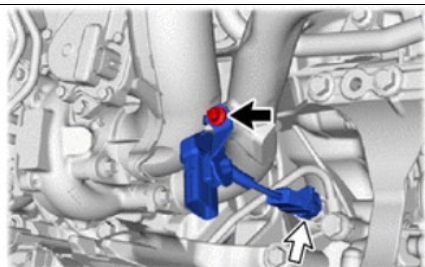

60. REMOVE NO. 10 ENGINE WIRE

61. DISCONNECT SUCTION HOSE SUB-ASSEMBLY



- Disconnect the connector.
- Remove the bolt and disconnect the suction hose sub-assembly.
- Remove the O-ring from the suction hose sub-assembly.

NOTE: Seal the openings of the disconnected parts using vinyl tape to prevent moisture and foreign matter from entering them.

62. REMOVE NO. 1 COOLER REFRIGERANT DISCHARGE HOSE

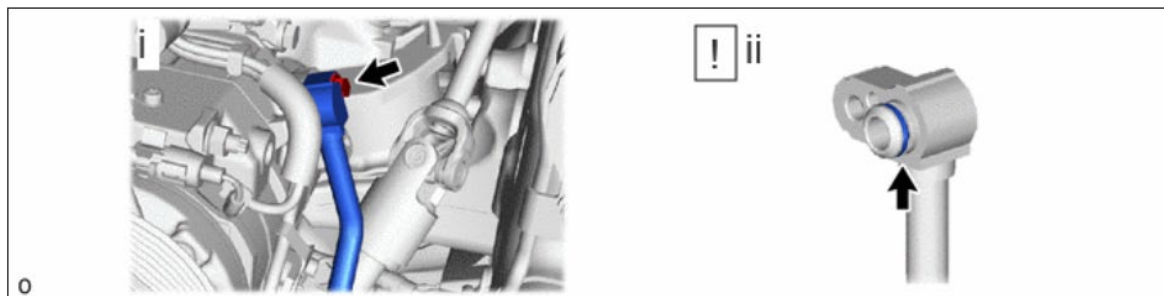

- Remove the bolt and No. 1 cooler refrigerant discharge hose.
- Remove the O-ring from the No. 1 cooler refrigerant discharge hose.

NOTE: Seal the openings of the disconnected parts using vinyl tape to prevent moisture and foreign matter from entering them.

63. REMOVE COOLING FAN WIRE

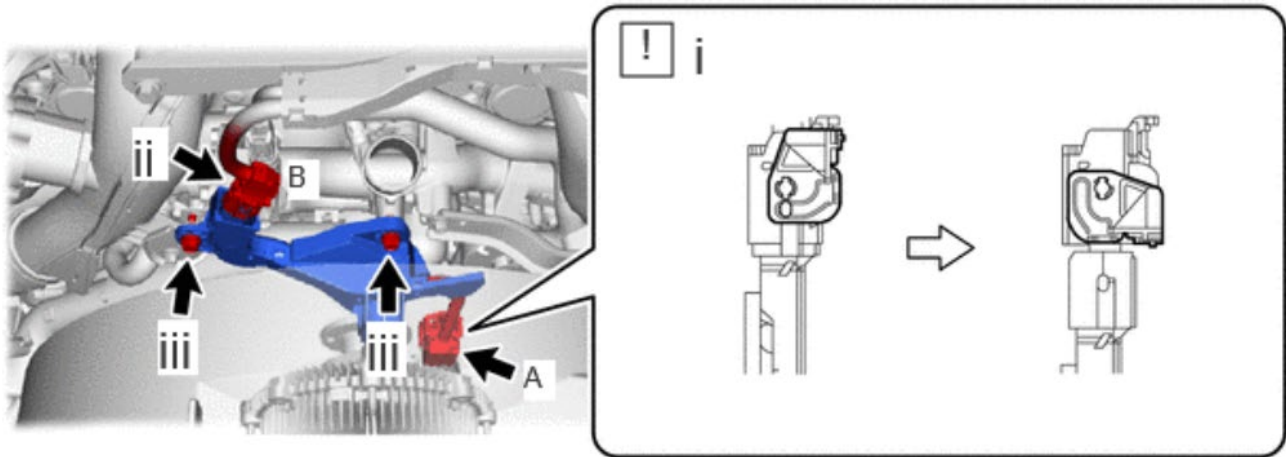

1. Push the lever down to release the lock and disconnect connector A.
2. Disconnect the connector B.
3. Remove the 2 bolts and cooling fan wire.

64. REMOVE NO. 1 V BELT (COOLER COMPRESSOR TO CRANKSHAFT PULLEY)

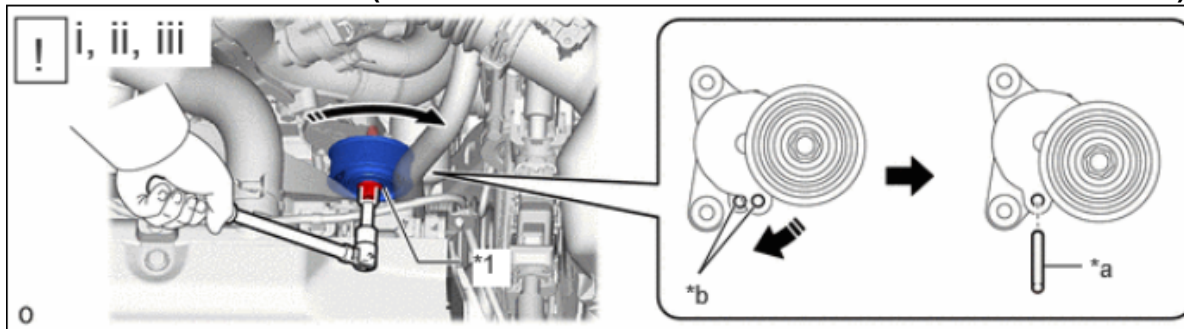

*1	V-ribbed Belt Tensioner Assembly	-	-
*a	5 mm Hexagon Wrench	*b	Hole
	Turn in this Direction	-	-

1. Release the No. 1 V belt (cooler compressor to crankshaft pulley) tension by turning the V-ribbed belt tensioner assembly clockwise and remove the No. 1 V belt (cooler compressor to crankshaft pulley) from the V-ribbed belt tensioner assembly.
2. Rotate the V-ribbed belt tensioner assembly clockwise to align the holes and then insert a 5 mm hexagon wrench to secure the V-ribbed belt tensioner assembly in place.
3. Remove the No. 1 V belt (cooler compressor to crankshaft pulley).

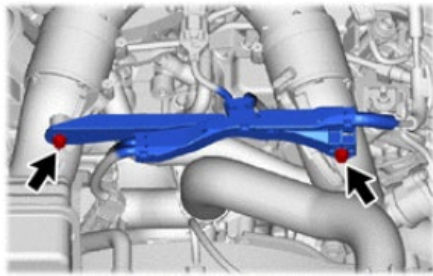

65. DISCONNECT ENGINE WIRE

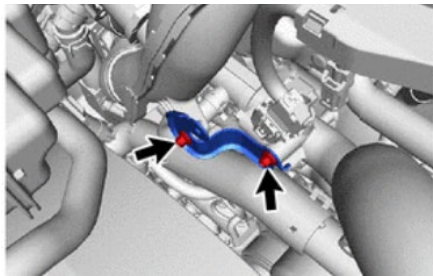

66. REMOVE NO. 1 AIR TUBE SUPPORT

67. REMOVE FAN AND GENERATOR V BELT

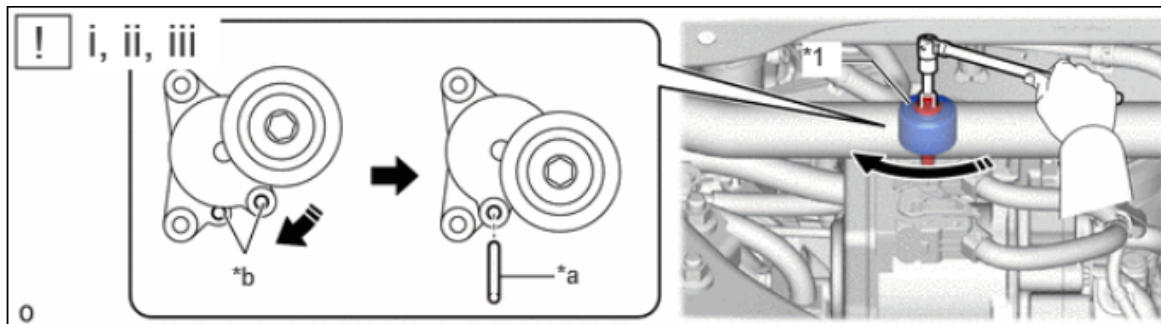

*1	V-ribbed Belt Tensioner Assembly	-	-
*a	5 mm Hexagon Wrench	*b	Hole
	Turn in this Direction	-	-

1. Release the fan and generator V belt tension by turning the V-ribbed belt tensioner assembly clockwise and remove the fan and generator V belt from the V-ribbed belt tensioner assembly.
2. Rotate the V-ribbed belt tensioner assembly clockwise to align the holes and then insert a 5 mm hexagon wrench to secure the V-ribbed belt tensioner assembly in place.
3. Remove the fan and generator V belt.

68. REMOVE FAN SHROUD

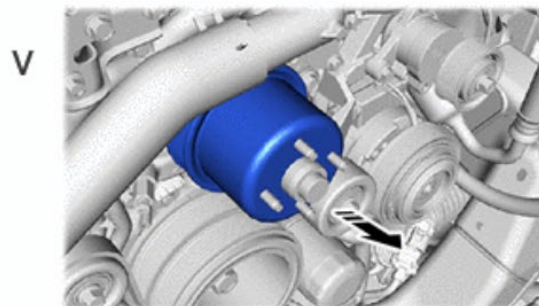
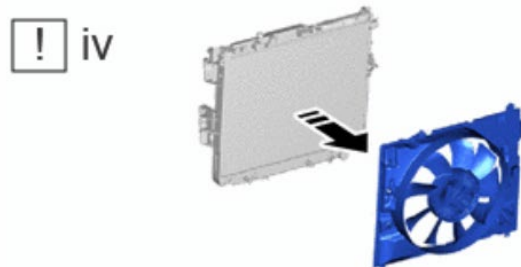
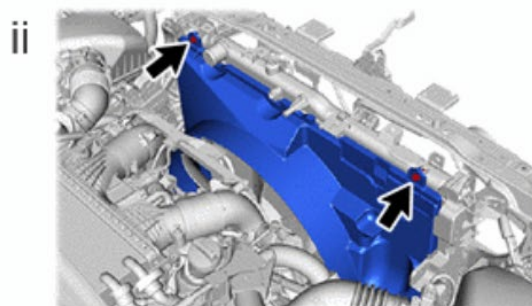
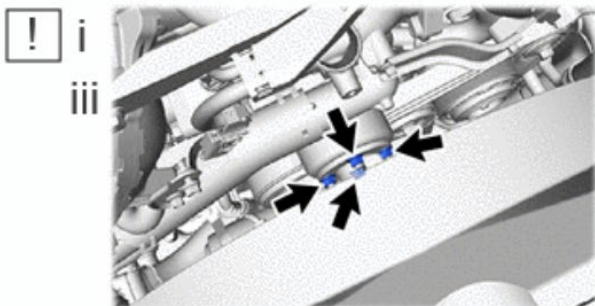

	Remove in this Direction	-	-
---	--------------------------	---	---

1. Loosen the 4 nuts holding the fluid coupling assembly with fan.
2. Remove the 2 bolts holding the fan shroud.
3. Remove the 4 nuts.
4. Remove the fan shroud together with the fluid coupling assembly with fan.

NOTE: Be careful not to damage the radiator core.

5. Remove the fan pulley from the engine water pump assembly.

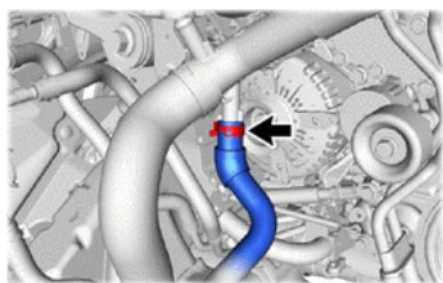

69. DISCONNECT NO. 3 WATER BY-PASS HOSE

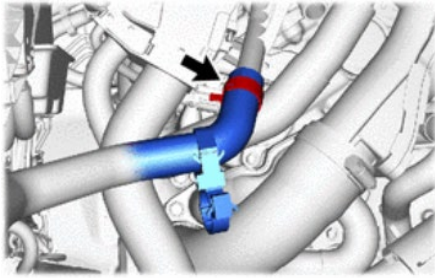

70. DISCONNECT NO. 4 WATER BY-PASS HOSE

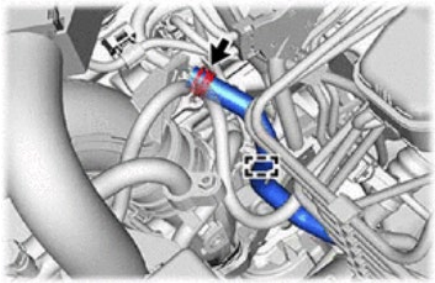

71. DISCONNECT NO. 1 FUEL VAPOR FEED HOSE

72. DISCONNECT HEATER WATER HOSE L

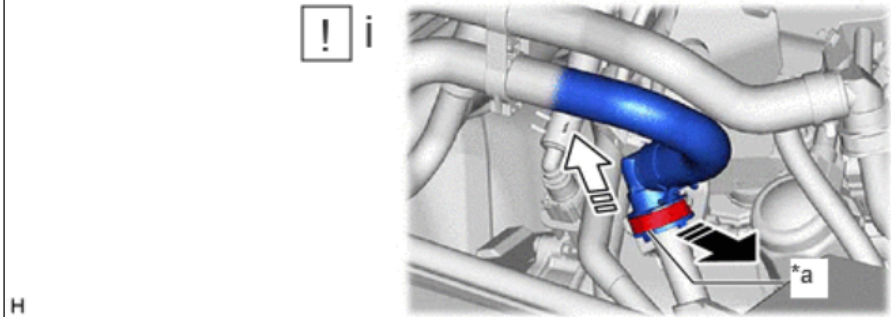

*a	Retainer	-	-
	Pull out		Pull off

a. Disconnect the heater water hose L connector from the water by-pass hose assembly.

NOTE: Remove any foreign matter on the water by-pass hose assembly and heater water hose L connector before performing this work.

1. Pull out the retainer to disengage the lock claws and pull off the heater water hose L connector.
2. Check that there is no foreign matter on the sealing surfaces of the disconnected water lines. Clean them if necessary.
3. Cover the disconnected heater water hose L connector with a plastic bag to prevent damage and contamination.

73. DISCONNECT OUTLET HEATER WATER HOSE

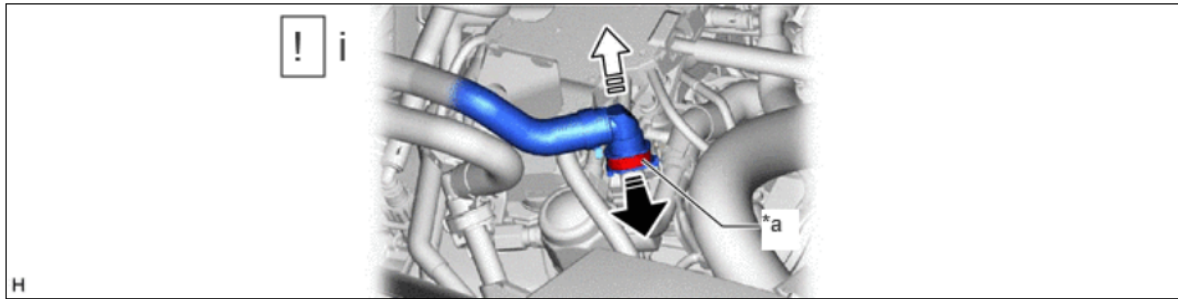

*a	Retainer	-	-
	Pull out		Pull off

- a. Disconnect the outlet heater water hose B connector from the No. 4 water by-pass pipe.

NOTE: Remove any foreign matter on the No. 4 water by-pass pipe and outlet heater water hose B connector before performing this work.

1. Pull out the retainer to disengage the lock claws and pull off the outlet heater water hose B connector.
2. Check that there is no foreign matter on the sealing surfaces of the disconnected water lines. Clean them if necessary.
3. Cover the disconnected outlet heater water hose B connector with a plastic bag to prevent damage and contamination.

74. DISCONNECT NO. 4 WATER BY-PASS HOSE ASSEMBLY

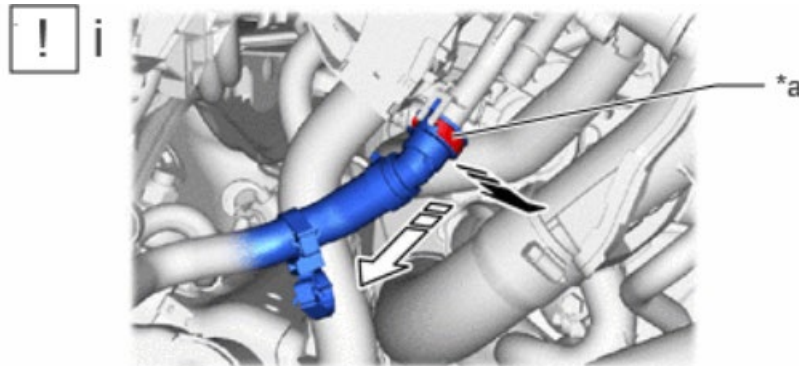

*a	Retainer	-	-
	Pull out		Pull off

- a. Disconnect the No. 4 water by-pass hose assembly connector from the water by-pass hose assembly.

NOTE: Remove any foreign matter on the water by-pass hose assembly and No. 4 water by-pass hose assembly connector before performing this work.

- b. Pull out the retainer to disengage the lock claws and pull off the No. 4 water by-pass hose assembly connector.
- c. Check that there is no foreign matter on the sealing surfaces of the disconnected water lines. Clean them if necessary.
- d. Cover the disconnected No. 4 water by-pass hose assembly connector with a plastic bag to prevent damage and contamination.

75. DISCONNECT NO. 1 VACUUM HOSE CONNECTOR

NOTE: Be sure to disconnect the No. 1 vacuum hose connector by hand.

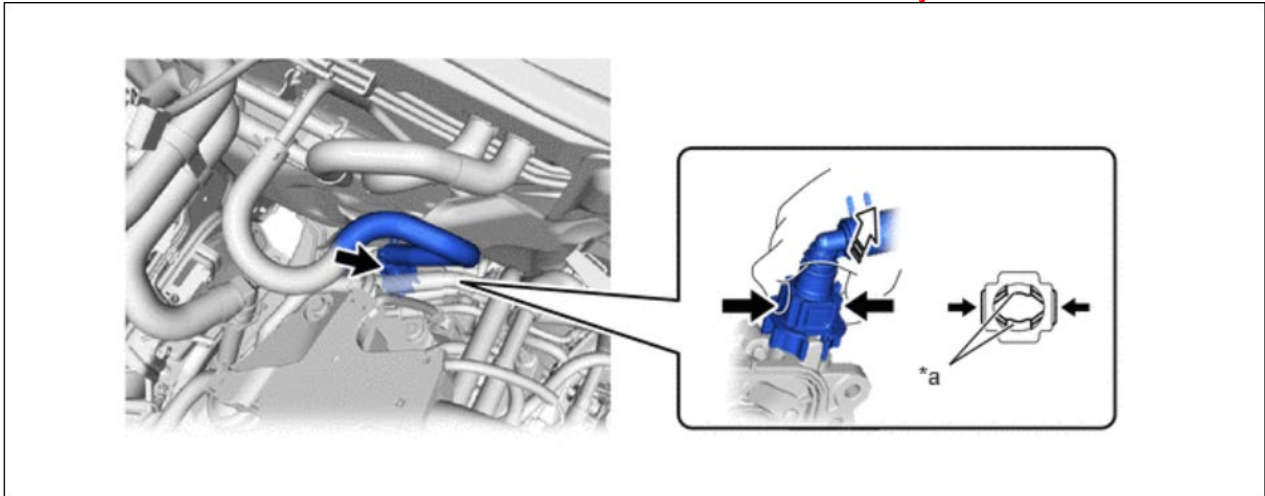

*a	Retainer	-	-
	Pinch		Pull off

- a. Pinch the retainer of the No. 1 vacuum hose connector, and then pull the No. 1 vacuum hose connector off of the vacuum pump assembly.

76. DISCONNECT SUCTION HOSE SUB-ASSEMBLY

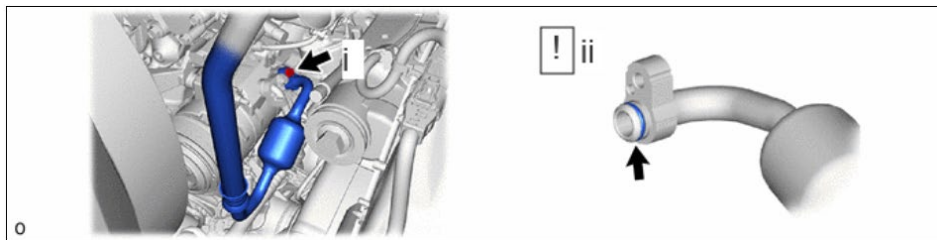

- a. Remove the bolt and disconnect the suction hose sub-assembly.
- b. Remove the O-ring from the suction hose sub-assembly.

77. DISCONNECT NO. 1 COOLER REFRIGERANT DISCHARGE HOSE



- a. Disconnect the connector.
- b. Remove the bolt and disconnect the No. 1 cooler refrigerant discharge hose.
- c. Remove the O-ring from the No. 1 cooler refrigerant discharge hose.

NOTE: Seal the openings of the disconnected parts using vinyl tape to prevent moisture and foreign matter from entering them.

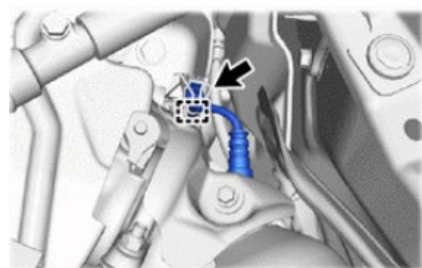

78. DISCONNECT AIR FUEL RATIO SENSOR

- a. Disconnect the air fuel ratio sensor connector
- b. Detach the wire harness clamp

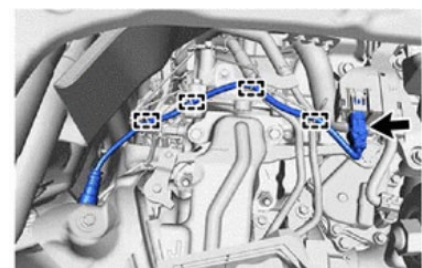

79. DISCONNECT NO. 2 AIR FUEL RATIO SENSOR

- a. Disconnect the air fuel ratio sensor connector
- b. Detach the 4 wire harness clamps

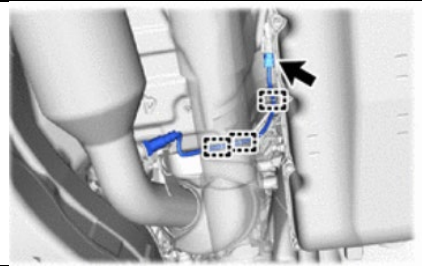

80. DISCONNECT NO. 3 AIR FUEL RATIO SENSOR

- a. Disconnect the air fuel ratio sensor connector
- b. Detach the 3 wire harness clamps

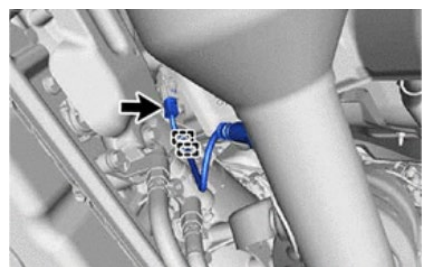

81. DISCONNECT NO. 4 AIR FUEL RATIO SENSOR

- a. Disconnect the air fuel ratio sensor connector
- b. Detach the 2 wire harness clamps

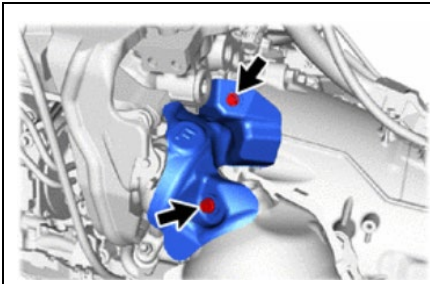

82. REMOVE NO. 4 TURBO INSULATOR

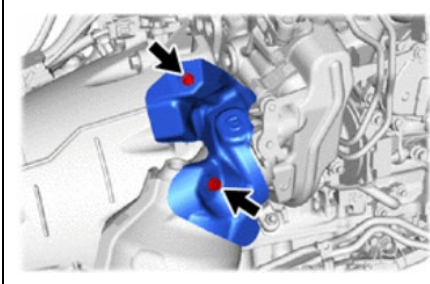

83. REMOVE NO. 2 TURBO INSULATOR

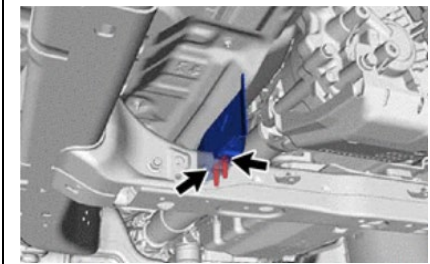

84. REMOVE NO. 2 PROPELLER SHAFT HEAT INSULATOR

85. REMOVE FRONT PROPELLER SHAFT ASSEMBLY

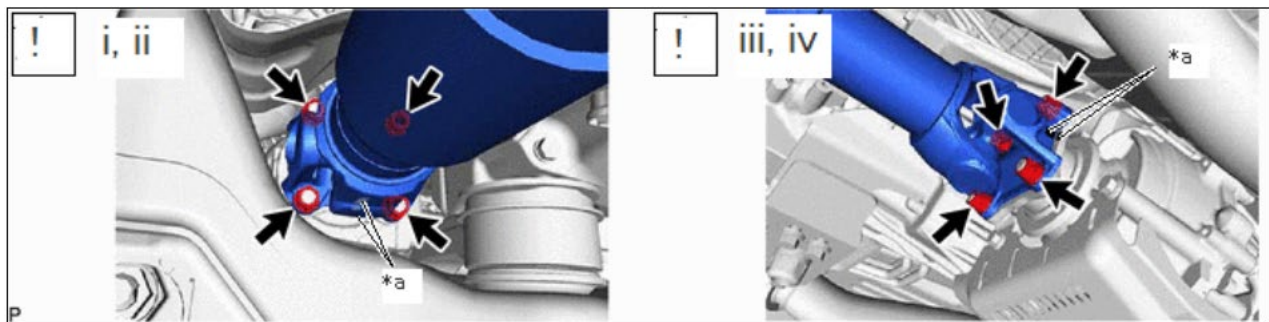

*a	Matchmark	-	-
----	-----------	---	---

- a. Place matchmarks on the propeller shaft flange and differential flange.
- b. Remove the 4 nuts and 4 washers.
- c. Place matchmarks on the propeller shaft flange and transfer flange.
- d. Remove the 4 nuts and 4 washers.

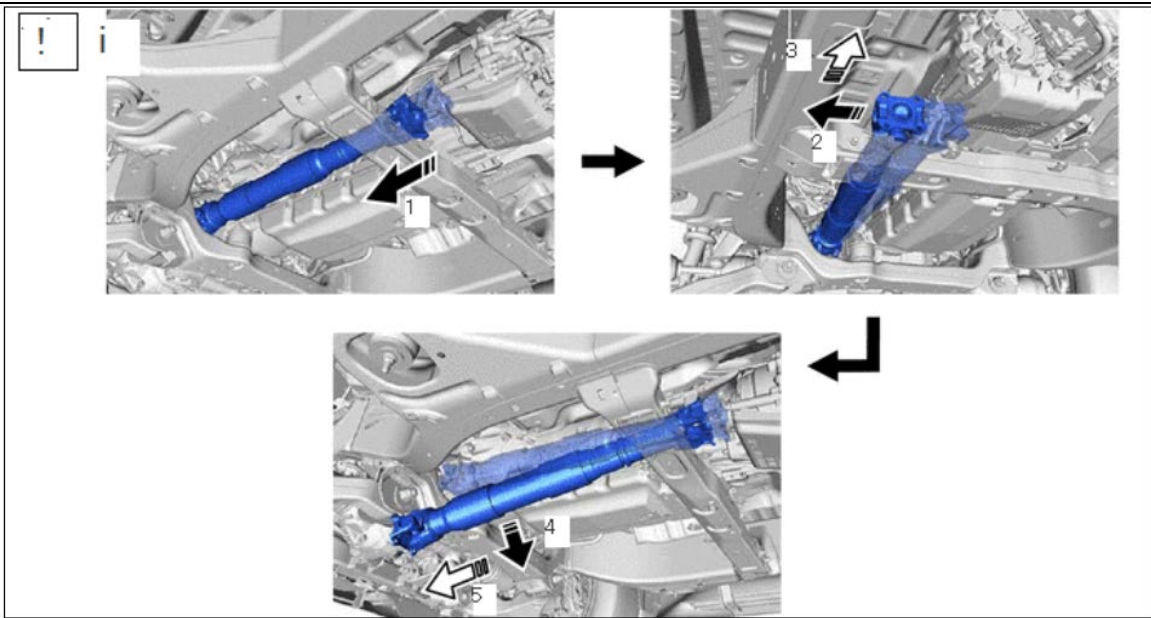

e. Remove the front propeller shaft assembly in the order shown in the illustration.

86. REMOVE CONVERTER WITH CATALYST ASSEMBLY LH

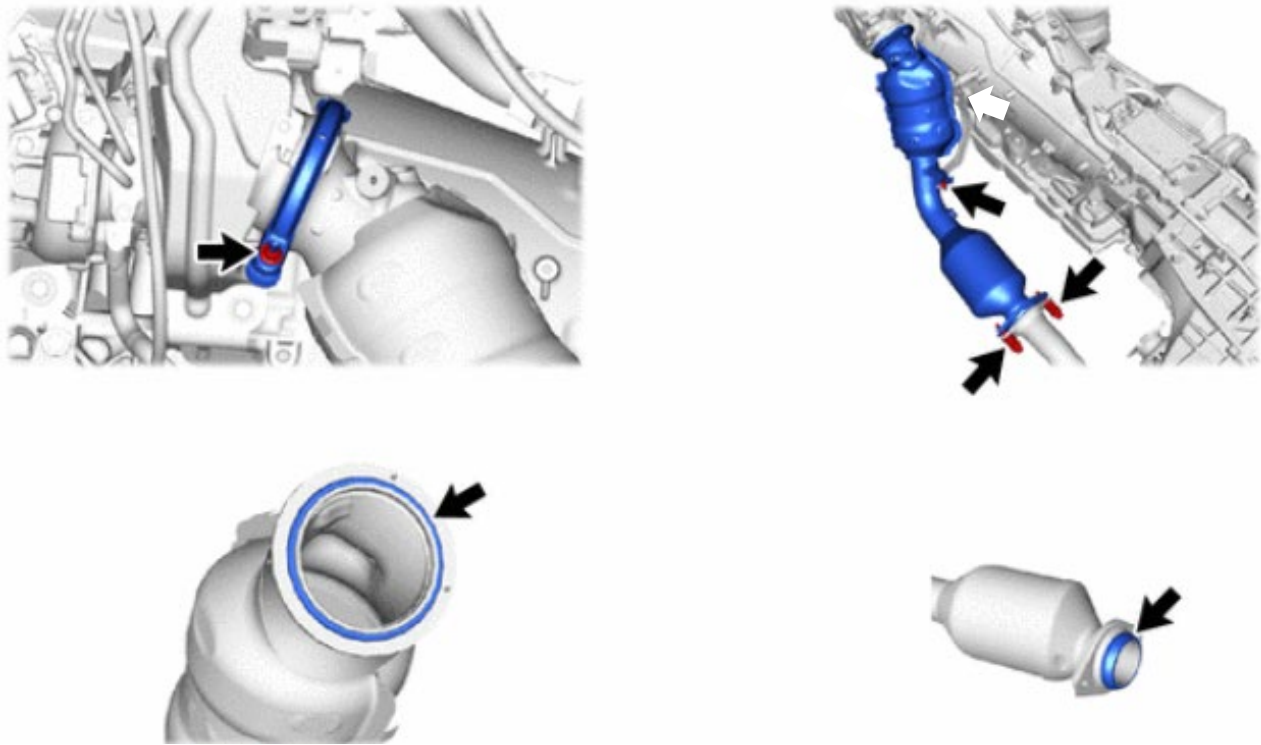

87. REMOVE CONVERTER WITH CATALYST ASSEMBLY RH

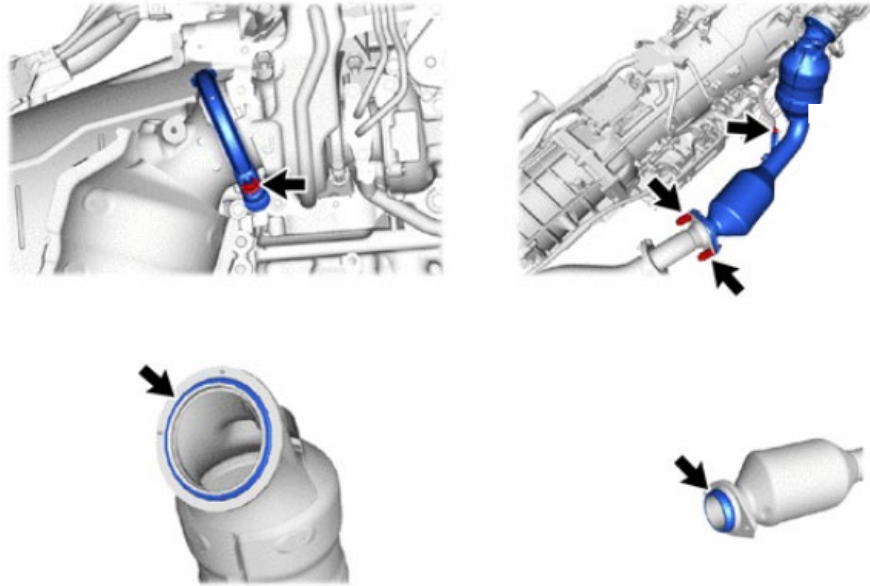

88. REMOVE NO. 2 MANIFOLD STAY

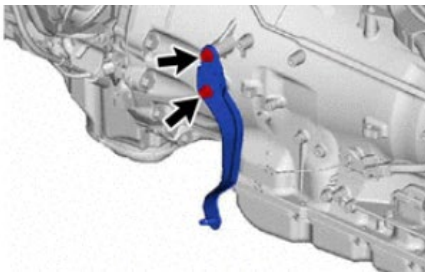

89. REMOVE MANIFOLD STAY

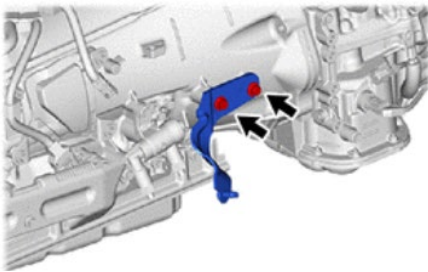

90. REMOVE STARTER COVER

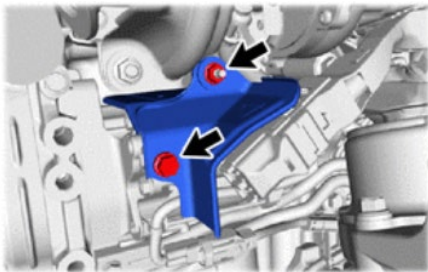

91. REMOVE STARTER ASSEMBLY

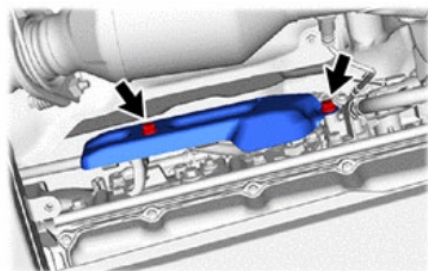
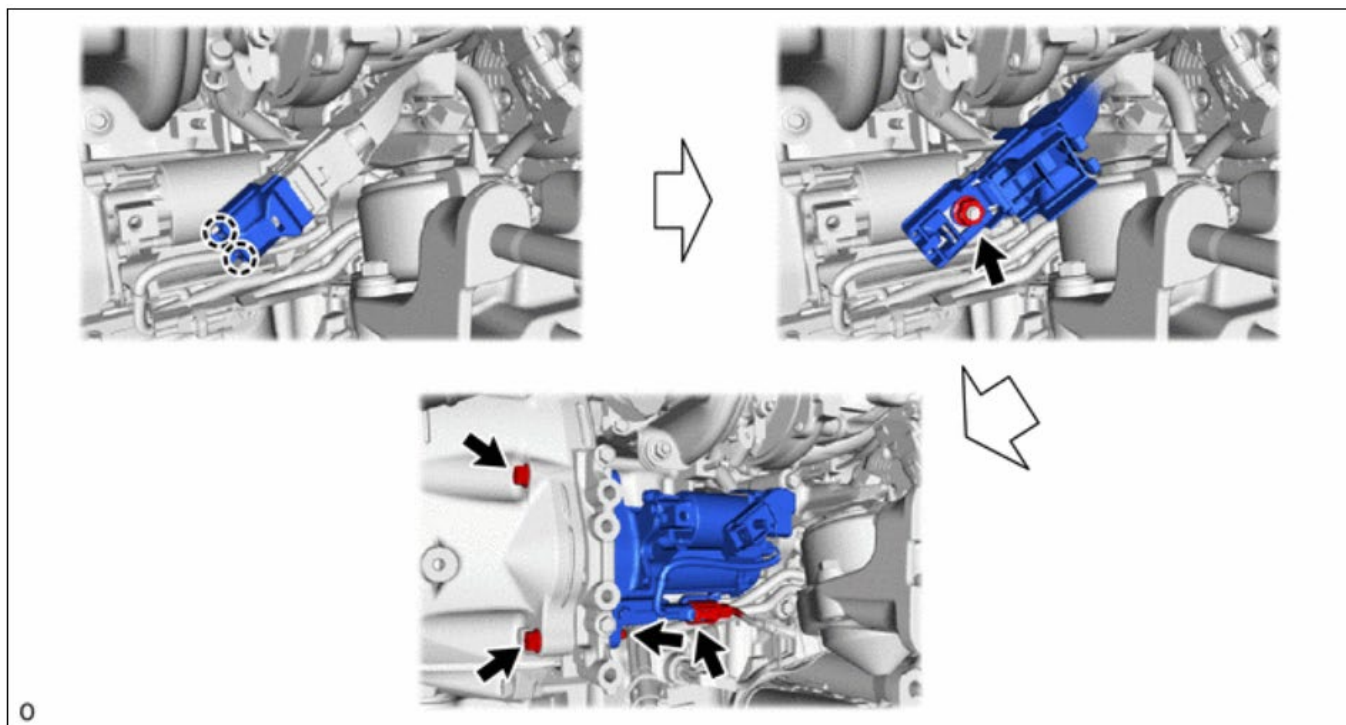

92. REMOVE TRANSMISSION CONTROL CABLE INSULATOR

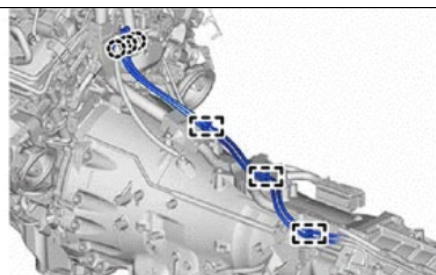

93. DISCONNECT TRANSFER BREATHER HOSE SUB-ASSEMBLY

NOTICE: The transfer breather hose sub-assembly can be disconnected without tilting the automatic transmission assembly with transfer assembly. When tilting the automatic transmission assembly with transfer assembly, do not tilt it excessively to allow the cooling fan and fan shroud to contact each other.

94. DISCONNECT TRANSMISSION/TRANSFER CASE WIRE HARNESS CONNECTIONS AND UNBOLT BRACKETS

NOTICE: The wire harness can be disconnected without tilting the automatic transmission assembly with transfer assembly. When tilting the automatic transmission assembly with transfer assembly, do not tilt it excessively to allow the cooling fan and fan shroud to contact each other.

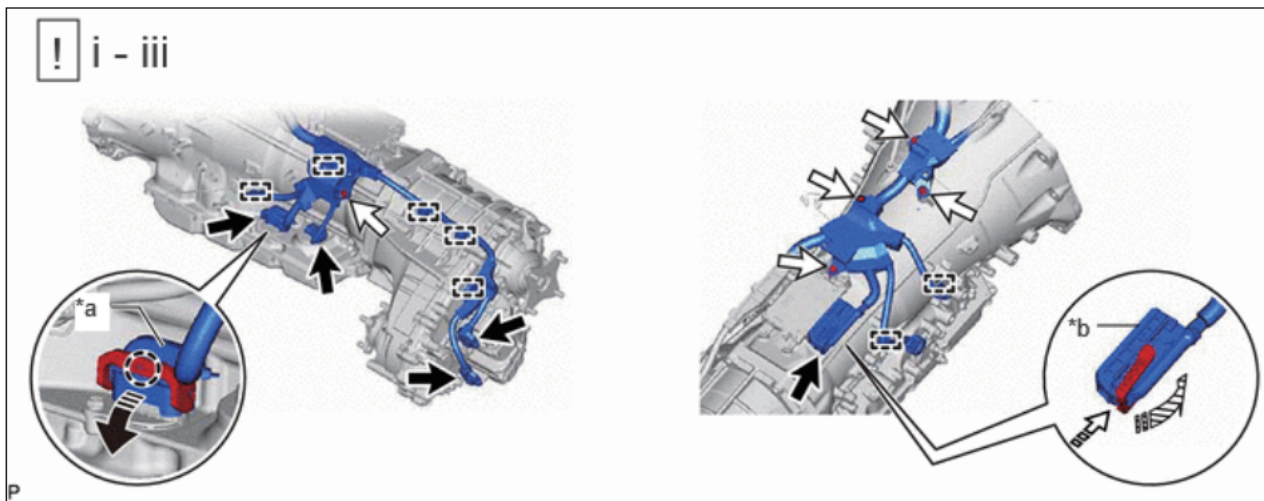

*a	Transmission Wire Connector	*b	TCM connector
	Connector		Bolt
	Pull Down the Lever		While Pressing the Lock
	Pull Up the Lever	-	-

a. Disconnect the 5 connectors.

NOTICE: Disconnect the claw, pull down the lever, and then disconnect the transmission wire connector. Disconnect the TCM connector lever while pressing the lever lock as shown in the illustration.

- b. Detach the clamp.
- c. Remove the 5 bolts and disconnect the wire harness from the automatic transmission assembly with transfer assembly.

95. REMOVE BELL HOUSING BOLTS

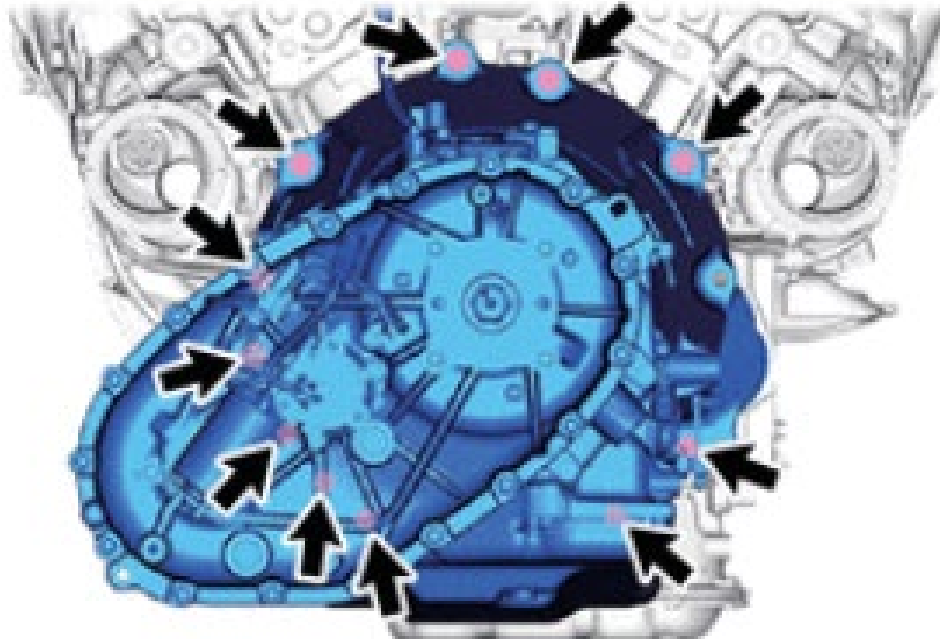

1. Remove the 11 bolts from the transmission assembly.

NOTE: Do not use excessive force to pry out the automatic transmission assembly with transfer assembly when separating it from the engine assembly to prevent the knock pins from being damaged.

96. REMOVE FLYWHEEL HOUSING SIDE COVER



1. Remove flywheel housing side cover
2. Remove the 6 drive plate and torque converter setting bolts from the drive plate and ring gear sub-assembly through the flywheel housing side cover hole.

NOTE: Turn the crankshaft to a position where the drive plate and torque converter setting bolts can be removed and remove the drive plate and torque converter setting bolts while securing the crankshaft pulley bolt with a wrench.

97. SEIZED ENGINE REMOVAL



IF ENGINE IS NOT SEIZED (CAN BE TURNED OVER BY HAND) SKIP THIS STEP.

NOTICE: Confirm starter is functional by ensuring it will spin freely. If starter does not spin freely by hand, the starter will need to be replaced.

1. If engine is seized (cannot be turned over by hand), follow these steps:
 - a. Using pole jack, stabilize rear of the engine to prevent twisting/shifting of the engine mounts due to the weight of the torque converter when removing the transmission.

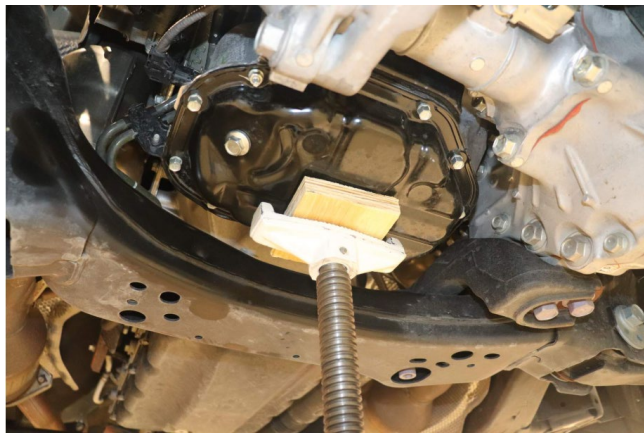

- b. Remove transmission while leaving torque converter attached to engine. Avoid excessive movement while removing transmission to avoid damage to the front pump.



c. Remove torque converter bolts using open ended wrench.



NOTICE: Carefully read the cautions written in the repair manual and perform the written instructions correctly.

98. PROTECT RADIATOR FINS BY ADDING A CARDBOARD SHEET OR PLYWOOD COVER

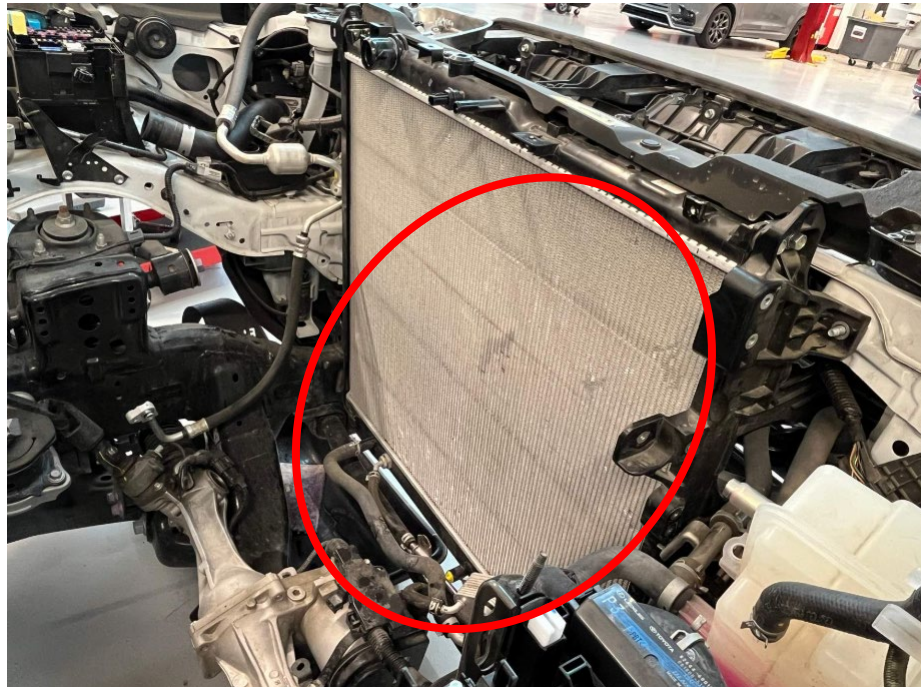

99. PROTECT WINSHEILD EDGE WITH PIPE INSULATOR.

Note: Use caution around the windshield defroster wire.

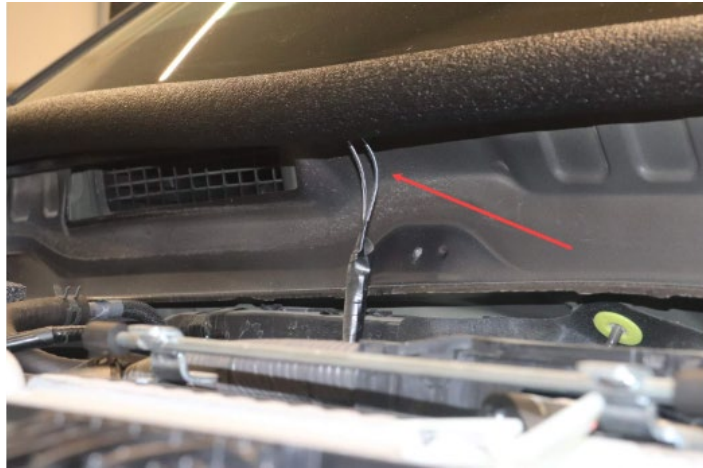

100. INSTALL/TORQUE SERVICE ENGINE HOOKS/BOLTS

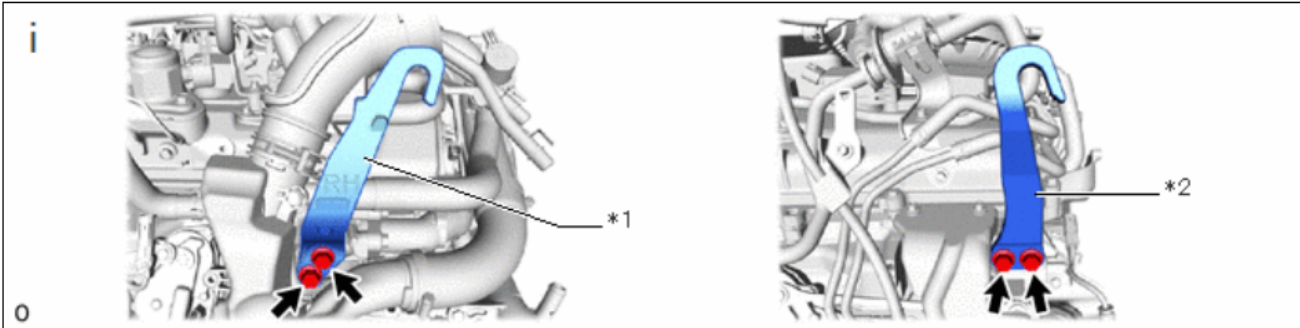

*1	No. 1 Engine Hanger	*2	No. 2 Engine Hanger
----	---------------------	----	---------------------

1. Using the hooks on the new engine assembly or service hooks/bolts, install the No. 1 engine hanger and No. 2 engine hanger with the 4 bolts as shown in the illustration.

Part Description	Part Number
Service Engine Hook No. 1	12281-70080
Service Engine Hook No. 2	12282-70050
Service Engine Hook Bolts	90105-A0354

Torque:

43 N·m {438 kgf·cm, 32 ft·lbf}

101. REMOVE ENGINE ASSEMBLY

NOTE: When attaching the engine lift chain to the engine crane boom-chain hook, make sure the entire chain link is placed inside the hook. Then, secure it by installing one or two through bolts of the appropriate size with a nut and washers to prevent any slipping while hoisting the engine as shown below.

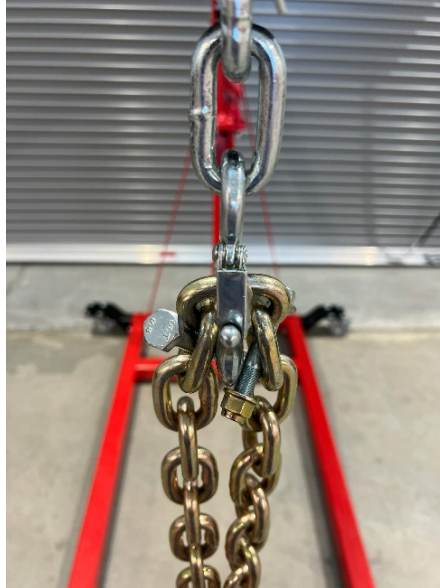

The chain must be centered, and the center of gravity set before installing the through bolts.

1. Attach an engine sling device and hang the engine with a chain block.
2. Using a 17 mm hexagon wrench, remove the 4 hexagon socket head cap bolts.

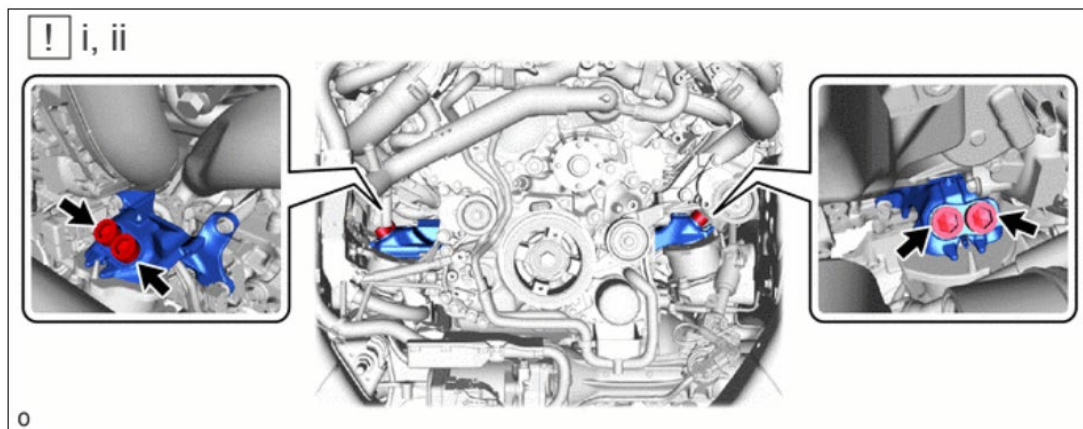

3. Remove the engine assembly by operating the engine sling device and chain block.

NOTE: Make sure that the engine is clear of all wiring and hoses. While removing the engine from the vehicle, do not allow it to contact the vehicle.

NOTE: Engine wiring harness will be removed with engine.

102. Transfer original components from original engine to new engine

- a. Transfer the following components from the **OLD** engine assembly to the **NEW** engine assembly.
 - Engine Wiring Harness
 - Generator
 - A/C Compressor
 - Drive Belt Tensioner
 - Drive Belts
 - Misc. hoses/brackets

1. REMOVE GENERATOR ASSEMBLY

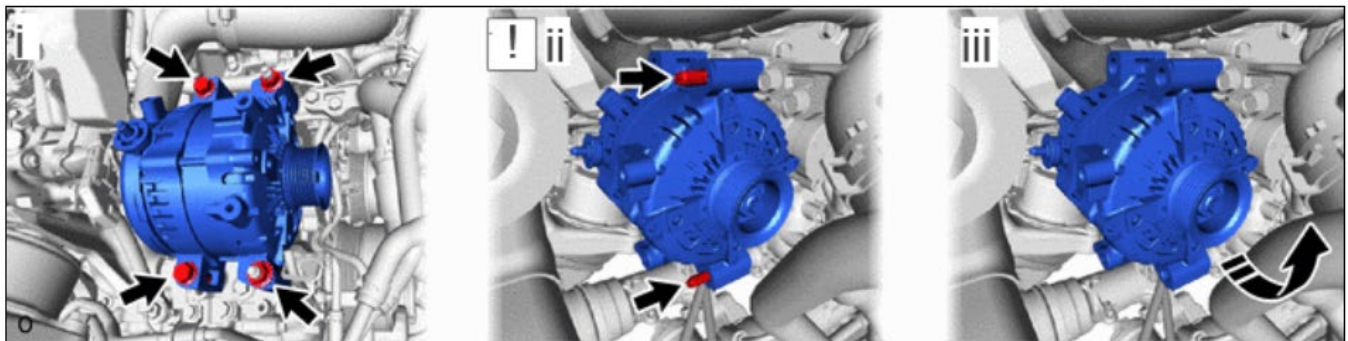

	Remove in this Direction	-	-
--	--------------------------	---	---

1. Remove the 2 bolts and 2 nuts.
2. Using an E8 "TORX" socket wrench, remove the 2 stud bolts and generator assembly.
3. Remove the generator assembly as shown in the illustration.

2. REMOVE COMPRESSOR WITH MAGNET CLUTCH

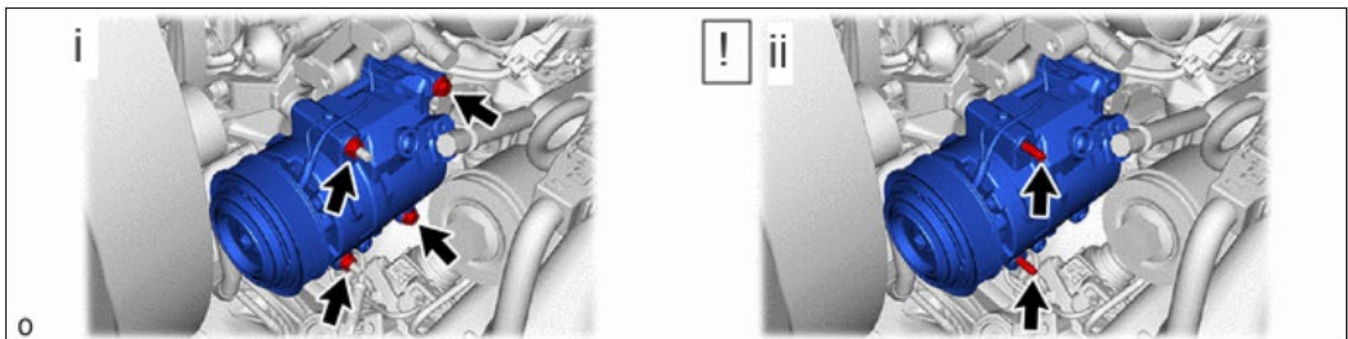

1. Remove the 2 bolts and 2 nuts.
2. Using an E8 "TORX" socket wrench, remove the 2 stud bolts and compressor with magnet clutch.

3. INSTALL COMPRESSOR WITH MAGNET CLUTCH

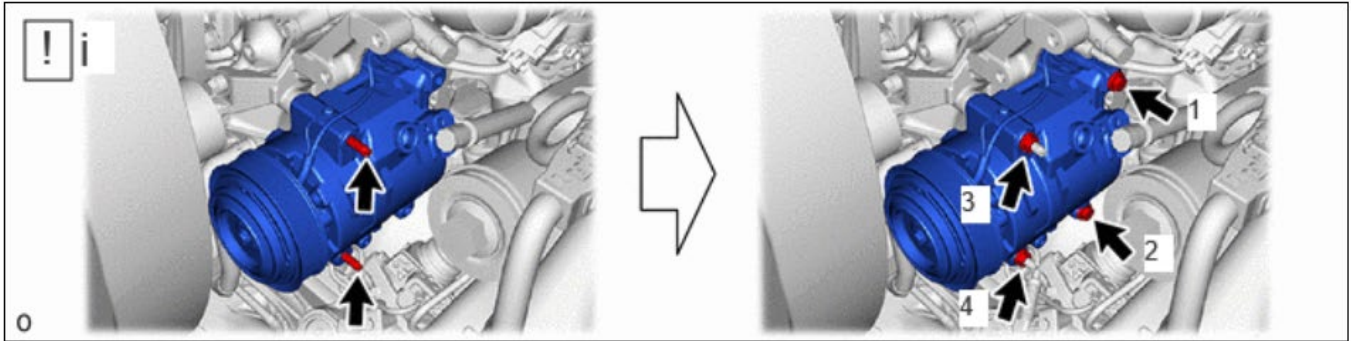

1. Using an E8 "TORX" socket wrench, temporarily install the compressor with magnet clutch with the 2 stud bolts.

Torque: 10 N·m {102 kgf·cm, 7 ft·lbf}

2. Install the compressor with magnet clutch with the 2 bolts and 2 nuts in the order shown in the illustration.

4. INSTALL GENERATOR ASSEMBLY



1. Using an E8 "TORX" socket wrench, temporarily install the generator assembly with the 2 stud bolts.

Torque: 10 N·m {102 kgf·cm, 7 ft·lbf}

2. Install the generator assembly with the 2 bolts and 2 nuts.

Torque: 43 N·m {438 kgf·cm, 32 ft·lbf}

5. Open V35A-FTS Engine Serial Number Registration Website

- a. Open the 24LA04 serial number registration website by selecting the following link:
<https://24la04.imagespm.info/>

- b. Confirm language of website

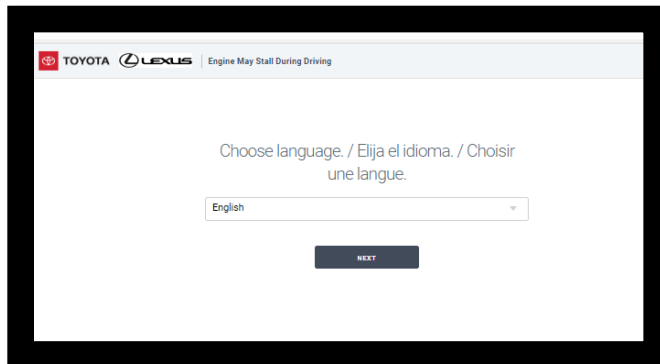

- c. Enter your dealer login credentials and follow the instructions to complete the engine serial number registration process.
Username: Dealer code
Password: XXXXX

Note: Default password is XXXXX. This password can be changed by the dealership after the first login. Please make sure all eligible technicians in your dealership know the password for your dealership.

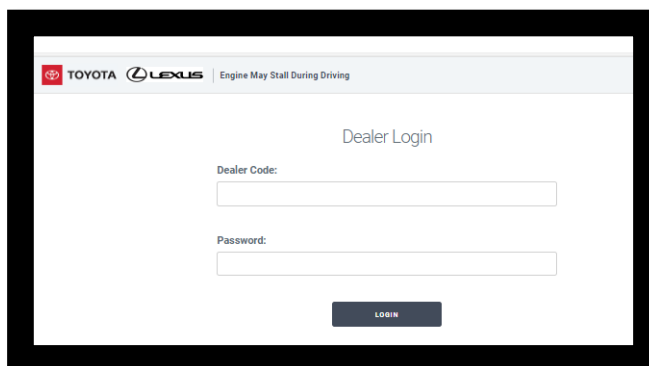

- d. Enter VIN

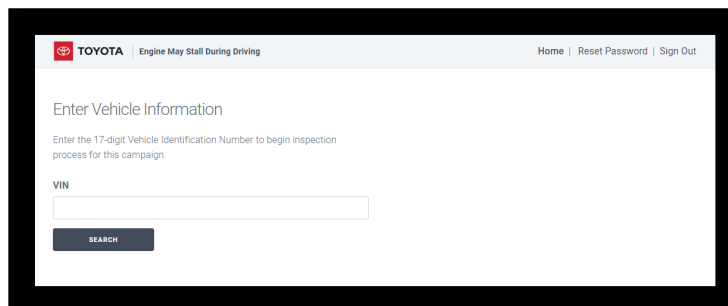

- e. Register original and new engine serial numbers.
- i. Enter **Original** Engine Serial Number (can be found on front of engine block or on sticker on top of intercooler)
 - ii. Upload photo of **New** Engine Serial Number
 - iii. Scan **New** Engine Serial Number (can be found on sticker on top of intercooler)
 - iv. Enter Technician Name
 - v. Enter Technician Email
 - vi. Enter Spin Number

NOTE: In order to register the serial number, the website requires a record of an engine being ordered for that VIN. If the VIN you enter goes to the parts order screen an engine has not yet been ordered for this vehicle.

TOYOTA | Engine May Stall During Driving | Home | Reset Password | Sign Out

Serial Number Registration

1. Enter Original Engine Serial Number

2. Upload Photo of Engine Serial Number (Confirm the picture is clear, see example above)

[Choose File] No file chosen

3. Scan New Engine Serial Number from Intercooler Barcode on top of engine (see example image above)

[USE ATTACHED SCANNER]

4. Technician Name

5. Technician Email

6. Technician SPIN Number

[SUBMIT] [BACK]

If the new engine serial number cannot be scanned in due to the intercooler label being damaged or missing, please contact quality_compliance@toyota.com with the following information:

- Dealer Code
- Technician Name
- SPIN Number
- Original Engine Serial Number on Block
- Photo of New Engine Serial Number on Block



If you have any issues, please email quality_compliance@toyota.com for further assistance.

f. Confirm all information was input correctly as shown below.

The screenshot displays a Toyota web portal interface. At the top left is the Toyota logo and the text "TOYOTA | Engine May Stall During Driving". At the top right are links for "Home | Reset Password | Sign Out". The main heading is "Serial number confirmation" with a "PRINT" button to its right. Below the heading is a message: "If you have any issues, please email quality_compliance@toyota.com for further assistance." A photograph of an engine block is shown, with a metal plate on the block containing the numbers "Z 22" and "0469". Below the photo, the following information is listed: "VIN: STF [redacted]", "Dealer Code: [redacted]", "Dealer Name: [redacted]", "SPIN ID: XXXXXXXX9456", "Technician Name: John Doe", "Original Serial number: A087945", and "New Engine Serial number: A453047".



Once a new engine serial number is registered to a VIN it must be used in that vehicle, no exceptions!

If you have any issues, please email quality_compliance@toyota.com for further assistance.

6. INSTALL ENGINE ASSEMBLY

NOTICE: Carefully read the cautions written in the repair manual and perform the written instructions correctly.



Ensure oil dip stick tube is not impacted during engine install. Impact to dip stick tube can cause tube to become unseated which can cause an oil leak. If you have any issues, please email quality_compliance@toyota.com for further assistance.



Ensure torque converter is seated correctly as shown below before installing engine assembly. If torque converter is not completely seated, damage may occur to transmission or engine. If you have any issues, please email quality_compliance@toyota.com for further assistance.

OK



NG

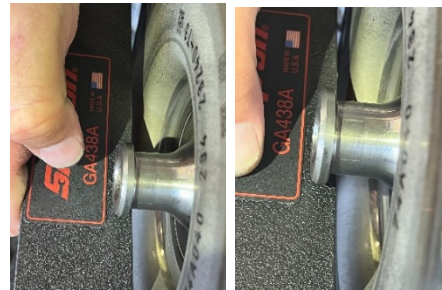

1. INSTALL ENGINE ASSEMBLY

! i, ii

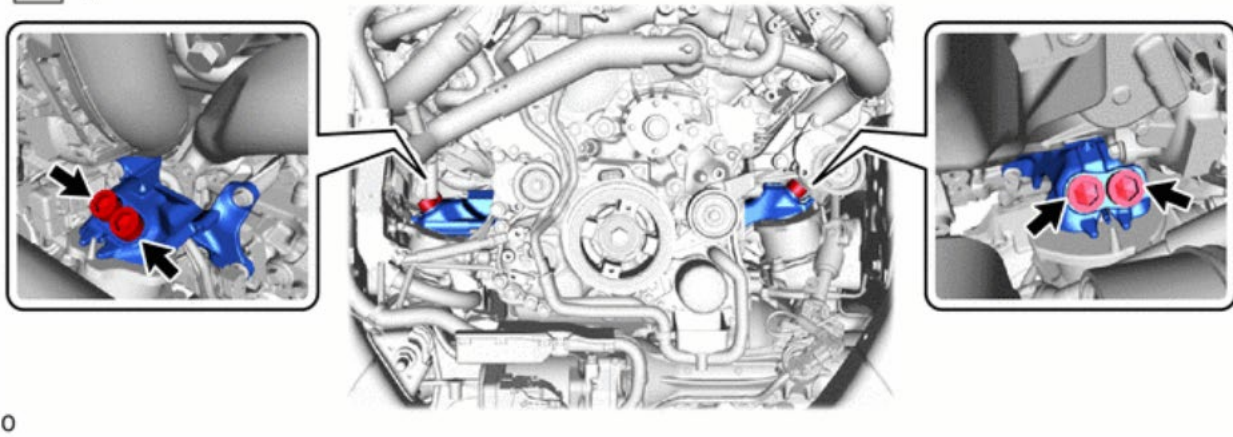

- Slowly lower the engine into the engine compartment.
- Using a 17 mm hexagon wrench, install the front engine mounting insulator LH and front engine mounting insulator RH with the 4 hexagon socket head cap bolts.

Torque: 144 N·m {1468 kgf·cm, 106 ft·lbf}

2. INSTALL BELL HOUSING BOLTS

*1	Drive Plate	*2	Crankshaft
*a	Matchmark	*b	Torque Converter Assembly Centerpiece
	Knock Pin		Bolt A
	Bolt B		Clutch Spline Grease

1. Confirm that the 2 knock pins are installed to the engine assembly and are not damaged.
2. Make sure that the matchmark is positioned as shown in the illustration.
3. Apply clutch spline grease to the surface of the crankshaft that contacts the torque converter assembly centerpiece.

Clutch Spline Grease:
Toyota Genuine Clutch Spline Grease or equivalent
Maximum Grease Amount:
Approximately 1 g (0.0353 oz.)

4. While keeping the engine assembly and automatic transmission assembly horizontal, align the 2 knock pins with the holes in the automatic transmission assembly and install the automatic transmission assembly with the 11 bolts.

Torque:
for bolt A :
71 N·m {724 kgf·cm, 52 ft·lbf}

for bolt B :
37 N·m {377 kgf·cm, 27 ft·lbf}

NOTE:

- Do not use excessive force when installing the automatic transmission assembly.
- When mounting the automatic transmission assembly to the engine assembly, make sure to securely fit the 2 knock pins into the knock holes.
- When tightening the bolts, make sure that the contact surfaces of the engine assembly and the automatic transmission assembly are in close contact with one another.
- When installing the automatic transmission assembly, make sure that the oil cooler tube does not become damaged.
- Check that the torque converter assembly rotates smoothly after installation of the automatic transmission assembly.

Item	Length
Bolt A	50 mm (1.97 in.)
Bolt B	45 mm (1.77 in.)

3. INSTALL DRIVE PLATE AND TORQUE CONVERTER SETTING BOLT



- a. Install the torque converter assembly to the drive plate and ring gear sub-assembly with the 6 drive plate and torque converter setting bolts through the flywheel housing cover hole.

Torque: 64 N·m {653 kgf·cm, 47 ft·lbf}

NOTE:

- Start by tightening the positioning drive plate and torque converter setting bolt (black), and then uniformly tighten the remaining 5 drive plate and torque converter setting bolts (silver).
- Turn the crankshaft to a position where the drive plate and torque converter setting bolts can be installed, and install the drive plate and torque converter setting bolts while securing the crankshaft pulley bolt with a wrench.

- b. Install flywheel housing cover

4. INSTALL STARTER ASSEMBLY

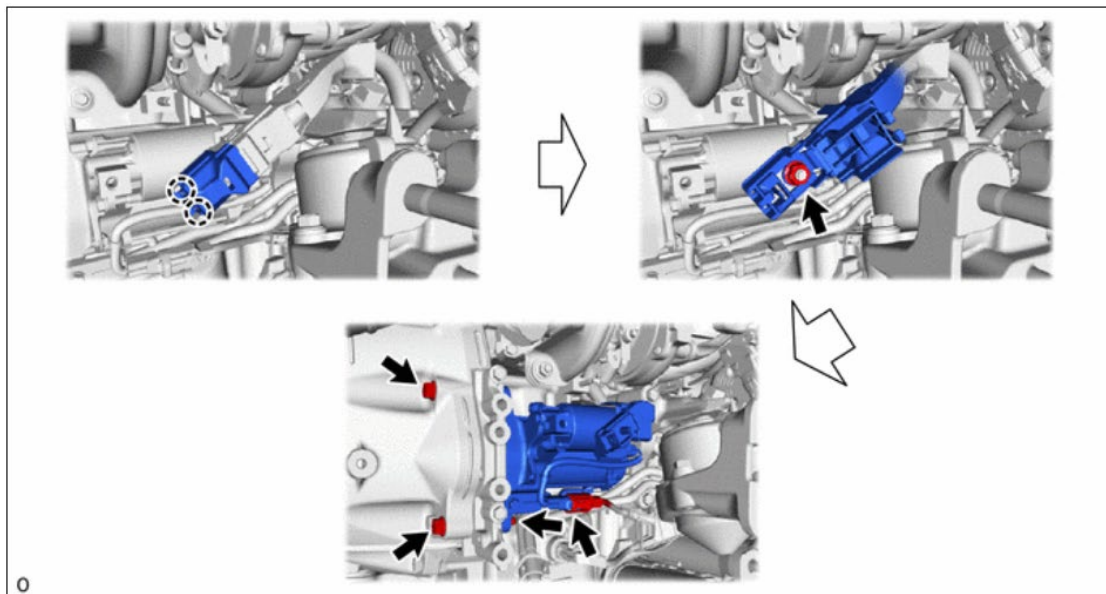

Torque:

Starter assembly : 46 N·m {469 kgf·cm, 34 ft·lbf}

Engine wire : 9.8 N·m {100 kgf·cm, 87 in·lbf}

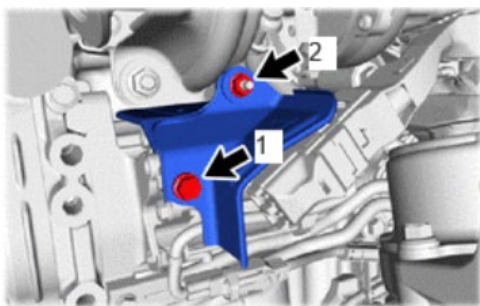

5. INSTALL STARTER COVER

- c. Temporarily install the starter cover with the bolt and nut.
- d. Tighten the bolt and nut in the order shown in the illustration.

Torque: 11.5 N·m {117 kgf·cm, 8 ft·lbf}

6. INSTALL CONVERTER WITH CATALYST ASSEMBLY RH

- e. Temporarily install a **NEW** gasket to the converter with catalyst assembly RH.
- f. Using a plastic-faced hammer and wooden block, tap in the gasket until its surface is flush with the converter with catalyst assembly RH.

! i, ii

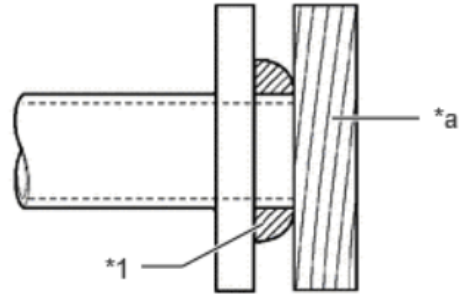

*1	Gasket	-	-
*a	Wooden Block	-	-

NOTE:

- Be sure to install the gasket so that it faces the correct direction.
- Do not reuse the OLD gasket.
- Do not damage the **NEW** gasket.

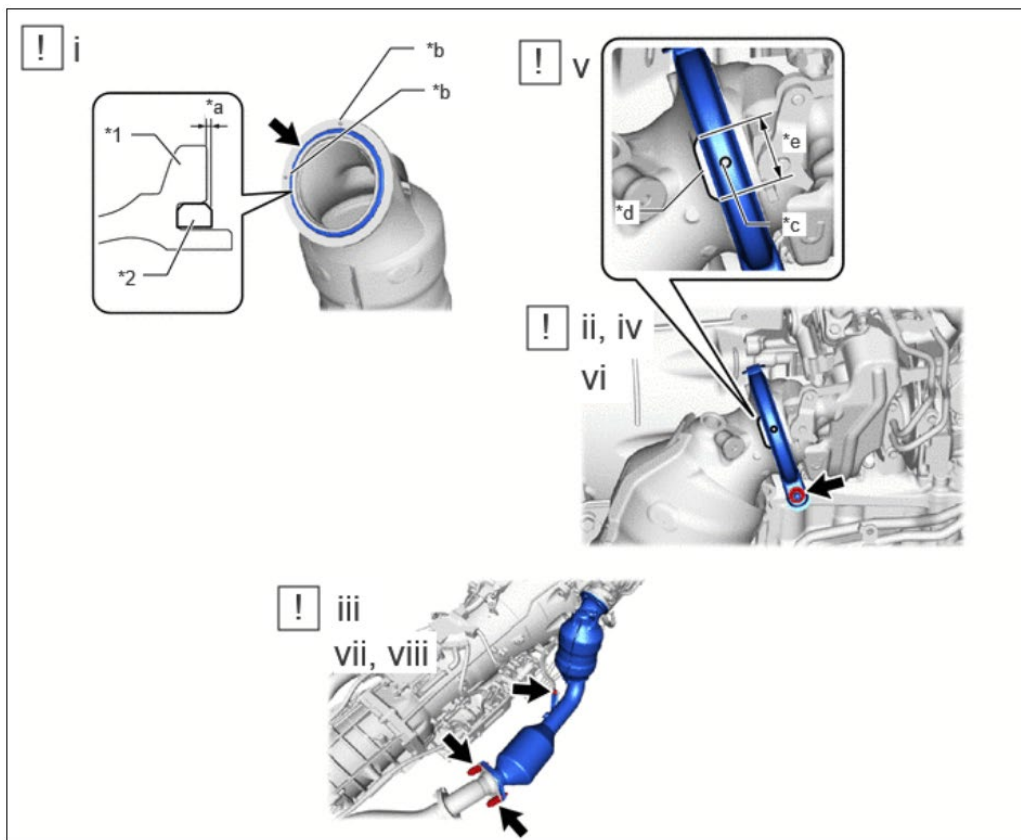

*1	Converter With Catalyst Assembly RH	*2	Turbine Outlet Elbow Gasket RH
*a	1.5 mm (0.0590 in.) or less	*b	Knock Pin
*c	Alignment Protrusion on Exhaust Pipe Clamp Side RH	*d	Alignment Protrusion on Converter With Catalyst Assembly RH Side
*e	Position Alignment Range	-	-

- g. Install a **NEW** turbine outlet elbow gasket RH to the converter with catalyst assembly RH as shown in the illustration.

NOTE: When reusing the converter with catalyst assembly RH, thoroughly clean the gasket groove so that no old gasket remains. Fully insert the **NEW** gasket into the gasket groove of the converter with catalyst assembly RH.

- h. Set a **NEW** exhaust pipe clamp RH to the converter with catalyst assembly RH.

NOTE: Make sure the end of the exhaust pipe clamp RH does not open 140 mm (5.51 in.) or more (standard amount approximately 60 mm (2.36 in.)).

- i. Temporarily install the converter with catalyst assembly RH to the manifold stay with the nut.

NOTE: Tighten the nut by hand until it contacts the surface.

- j. Align the converter with catalyst assembly RH with the knock hole on the No. 2 turbocharger sub-assembly side to connect the converter with catalyst assembly RH.

NOTE: Make sure that there is a knock pin on the converter with catalyst assembly RH.

- k. Align the flange surfaces of the No. 2 turbocharger sub-assembly and converter with catalyst assembly RH, and then temporarily install the exhaust pipe clamp RH.

NOTE: Make sure that there is a knock pin on the converter with catalyst assembly RH.

- l. Align the position alignment protrusions on the exhaust pipe clamp RH side to within the range of the position alignment protrusions on the converter with catalyst assembly RH side.

- m. Tighten the exhaust pipe clamp RH.

Torque: 25 N·m {255 kgf·cm, 18 ft·lbf}

- n. Tighten the nut.

Torque: 43 N·m {438 kgf·cm, 32 ft·lbf}

- o. Connect the converter with catalyst assembly RH to the front exhaust pipe assembly with the 2 compression springs and 2 bolts.

Torque: 43 N·m {438 kgf·cm, 32 ft·lbf}

7. INSTALL CONVERTER WITH CATALYST ASSEMBLY LH

- p. Temporarily install a **NEW** gasket to the converter with catalyst assembly LH.
- q. Using a plastic-faced hammer and wooden block, tap in the gasket until its surface is flush with the converter with catalyst assembly LH.

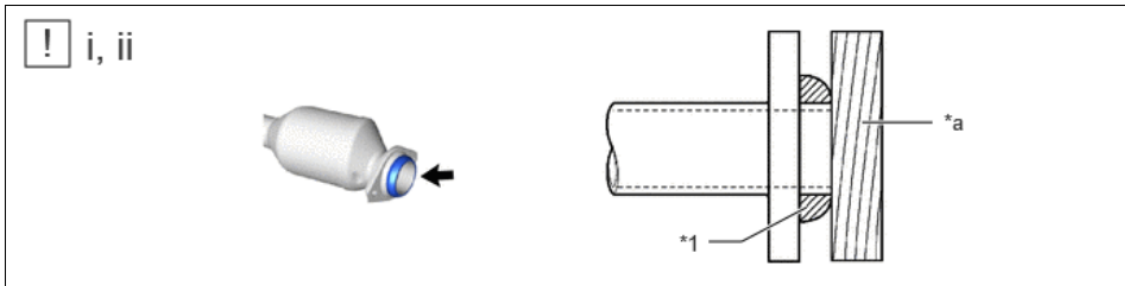

*1	Gasket	-	-
*a	Wooden Block	-	-

NOTE:

- Be sure to install the gasket so that it faces the correct direction.
- Do not reuse the OLD gasket.
- Do not damage the **NEW** gasket.

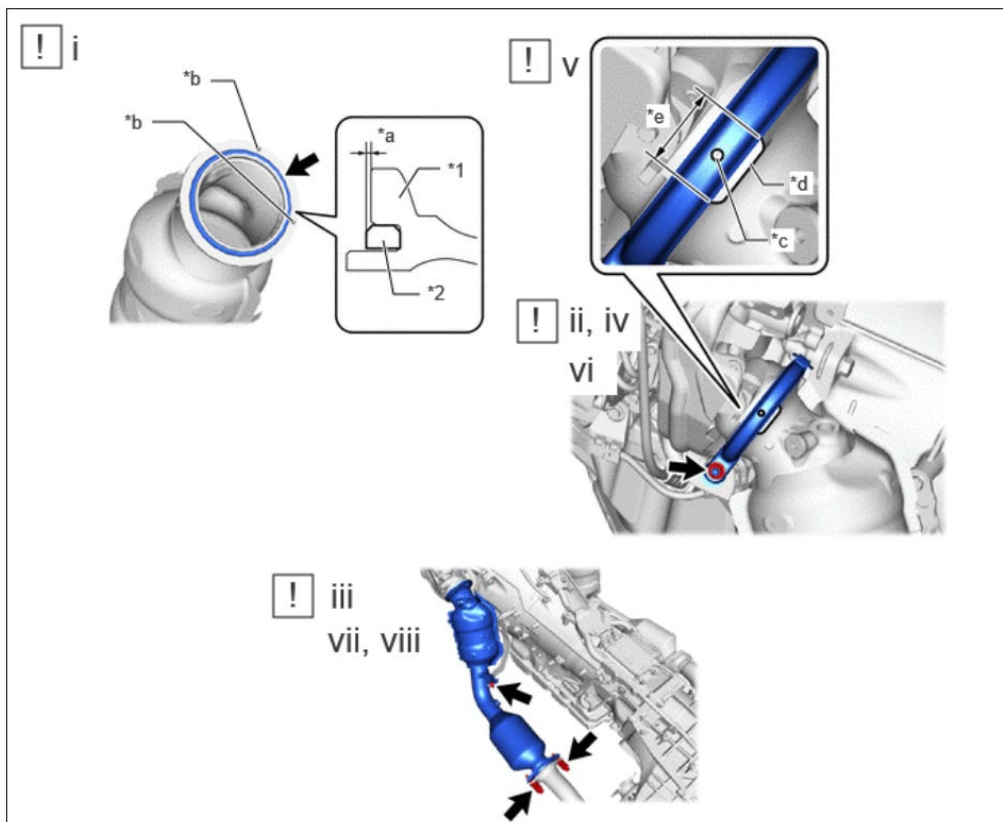

*1	Converter With Catalyst Assembly LH	*2	Turbine Outlet Elbow Gasket LH
*a	1.5 mm (0.0590 in.) or less	*b	Knock Pin
*c	Alignment Protrusion on Exhaust Pipe Clamp Side LH	*d	Alignment Protrusion on Converter With Catalyst Assembly LH Side
*e	Position Alignment Range	-	-

- r. Install a **NEW** turbine outlet elbow gasket LH to the converter with catalyst assembly LH as shown in the illustration.

NOTE: When reusing the converter with catalyst assembly RH, thoroughly clean the gasket groove so that no old gasket remains. Fully insert the **NEW** gasket into the gasket groove of the converter with catalyst assembly LH.

- s. Set a **NEW** exhaust pipe clamp LH to the converter with catalyst assembly LH.

NOTE: Make sure the end of the exhaust pipe clamp RH does not open 140 mm (5.51 in.) or more (standard amount approximately 60 mm (2.36 in.)).

- t. Temporarily install the converter with catalyst assembly LH to the manifold stay with the nut.

NOTE: Tighten the nut by hand until it contacts the surface.

- u. Align the converter with catalyst assembly LH with the knock hole on the No. 1 turbocharger sub-assembly side to connect the converter with catalyst assembly LH.

NOTE: Make sure that there is a knock pin on the converter with catalyst assembly LH.

- v. Align the flange surfaces of the No. 1 turbocharger sub-assembly and converter with catalyst assembly LH, and then temporarily install the exhaust pipe clamp LH.

NOTE: Make sure that there is a knock pin on the converter with catalyst assembly LH.

- w. Align the position alignment protrusions on the exhaust pipe clamp LH side to within the range of the position alignment protrusions on the converter with catalyst assembly LH side.

- x. Tighten the exhaust pipe clamp LH.

Torque: 25 N·m {255 kgf·cm, 18 ft·lbf}

- y. Tighten the nut.

Torque: 43 N·m {438 kgf·cm, 32 ft·lbf}

- z. Connect the converter with catalyst assembly LH to the front exhaust pipe assembly with the 2 compression springs and 2 bolts.

Torque: 43 N·m {438 kgf·cm, 32 ft·lbf}

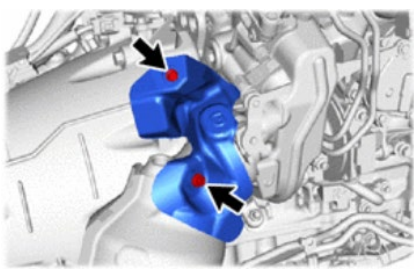
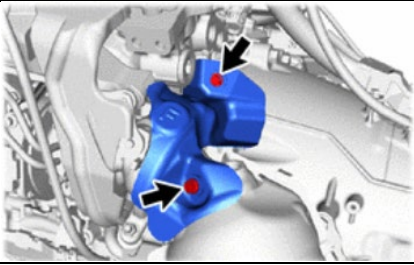
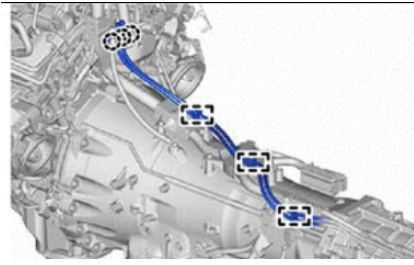
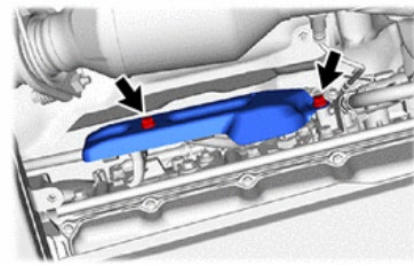
	<p>8. INSTALL NO. 2 TURBO INSULATOR</p> <p>Torque: 10 N·m {102 kgf·cm, 7 ft·lbf}</p>
	<p>9. INSTALL NO. 4 TURBO INSULATOR</p> <p>Torque: 10 N·m {102 kgf·cm, 7 ft·lbf}</p>
	<p>10. CONNECT TRANSFER BREATHER HOSE SUB-ASSEMBLY</p> <p>NOTICE: The transfer breather hose sub-assembly can be connected without tilting the automatic transmission assembly with transfer assembly. When tilting the automatic transmission assembly with transfer assembly, do not tilt it excessively to allow the cooling fan and fan shroud to contact each other.</p>
	<p>11. INSTALL TRANSMISSION CONTROL CABLE INSULATOR</p> <p>a. Install the transmission control cable insulator to the automatic transmission assembly with the 2 bolts.</p> <p>NOTICE: Tightening order: Temporarily install bolt A and bolt B → Tighten bolt A → Tighten bolt B</p> <p>Torque: 12 N·m {122 kgf·cm, 9 ft·lbf}</p>

12. CONNECT TRANSMISSION/TRANSFER CASE WIRE HARNESS CONNECTIONS AND BRACKETS

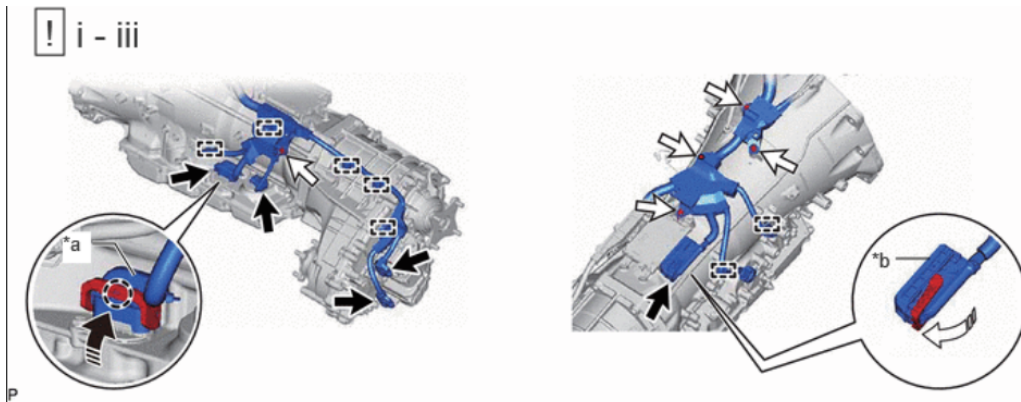

*a	Transmission Wire Connector	*b	TCM connector
	Connector		Bolt
	Push Up		Securely Lock

- a. Connect the wire harness to the automatic transmission assembly with transfer assembly with the 5 bolts.

Torque: 10 N·m {102 kgf·cm, 7 ft·lbf}

- b. Attach the clamp.
- c. Connect the 5 connectors.

NOTE: Push up the lever until the claw of the transmission wire connector makes a connection sound. Securely lock the TCM connector lever.

13. INSTALL NO. 2 MANIFOLD STAY

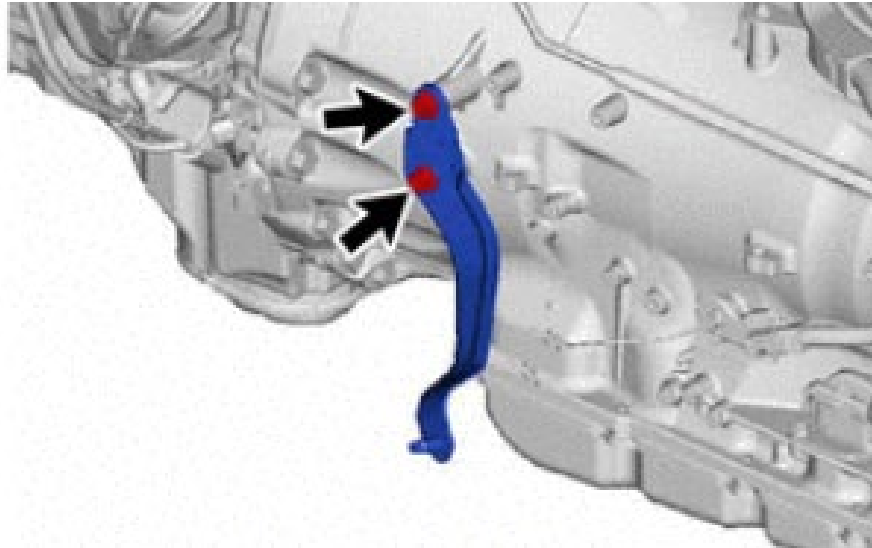

Torque: 43 N·m {438 kgf·cm, 32 ft·lbf}

14. INSTALL NO. 2 MANIFOLD STAY

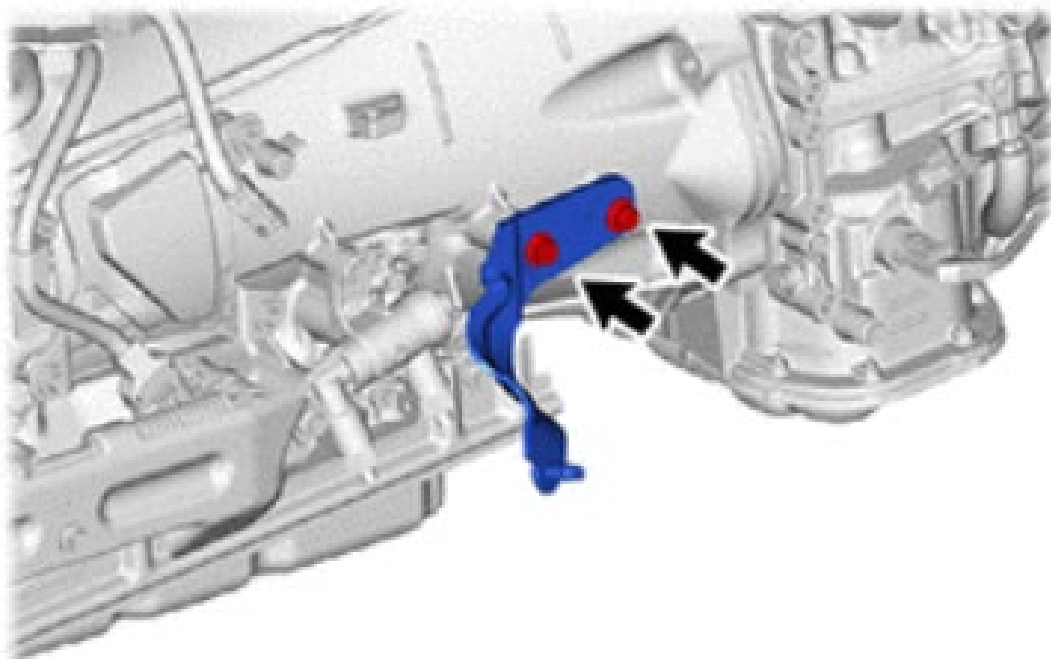

Torque: 43 N·m {438 kgf·cm, 32 ft·lbf}

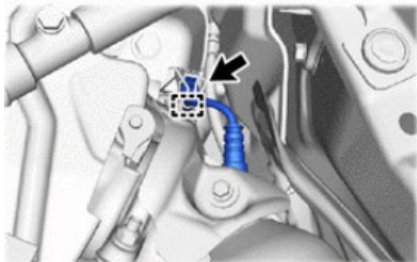

15. CONNECT AIR FUEL RATIO SENSOR

- a. Connect the air fuel ratio sensor connector
- b. Attach the wire harness clamp

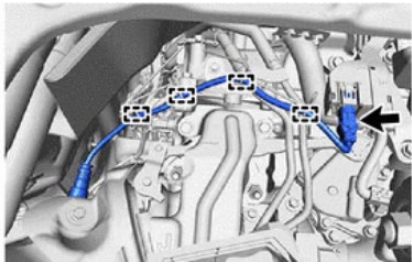

16. CONNECT NO. 2 AIR FUEL RATIO SENSOR

- a. Connect the air fuel ratio sensor connector
- b. Attach the 4 wire harness clamps

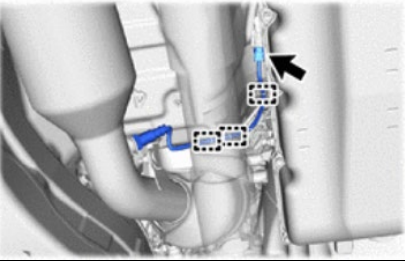

17. CONNECT NO. 3 AIR FUEL RATIO SENSOR

- a. Connect the air fuel ratio sensor connector
- b. Attach the 3 wire harness clamps

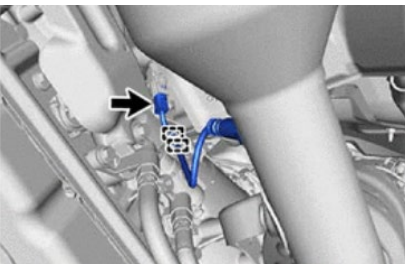

18. CONNECT NO. 4 AIR FUEL RATIO SENSOR

- a. Connect the air fuel ratio sensor connector
- b. Attach the 2 wire harness clamps

19. INSTALL FRONT PROPELLER SHAFT ASSEMBLY

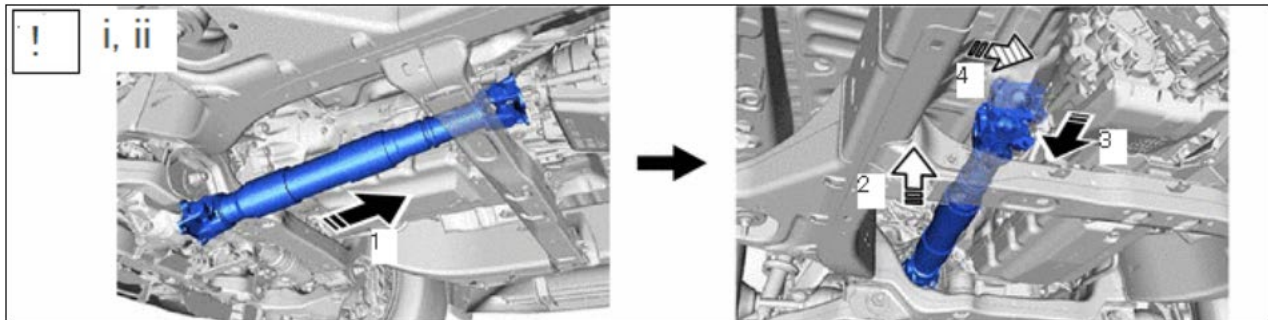

- a. Completely remove any oil, etc. and clean the contact surfaces of the 2 propeller shaft flanges, differential flange and transfer flange.
- b. Temporarily install the front propeller shaft assembly to the transfer and differential in the order shown in the illustration.

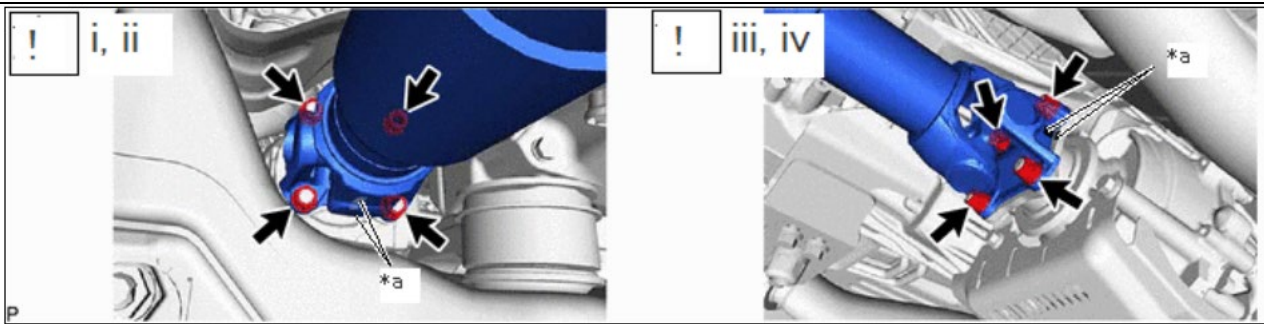

*a	Matchmark	-	-
----	-----------	---	---

- c. Align the matchmarks on the propeller shaft flange and differential flange.
- d. Install the front propeller shaft assembly with the 4 nuts and 4 washers.

Torque: 88.3 N·m {900 kgf·cm, 65 ft·lbf}

- e. Align the matchmarks on the propeller shaft flange and transfer flange.
- f. Install the front propeller shaft assembly with the 4 nuts and 4 washers.

Torque: 88.3 N·m {900 kgf·cm, 65 ft·lbf}

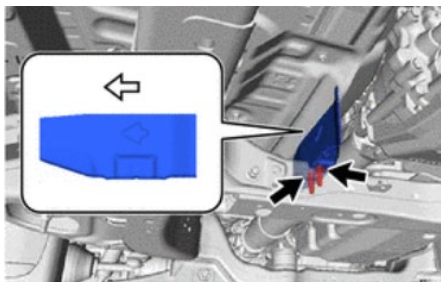

20. INSTALL NO. 2 PROPELLER SHAFT HEAT INSULATOR

- a. Install the No. 2 propeller shaft heat insulator with the 2 bolts.

Torque: 15.7 N·m {160 kgf·cm, 12 ft·lbf}

NOTICE: Install so that the direction of the arrow points to the front of the vehicle.

21. CONNECT NO. 1 COOLER REFRIGERANT DISCHARGE HOSE



- a. Connect the compressor connector.
- b. Remove the vinyl tape from the No. 1 cooler refrigerant discharge hose and connecting part of the compressor with magnet clutch and then sufficiently apply compressor oil to a **NEW** O-ring and the fitting surface of the No. 1 cooler refrigerant discharge hose.

Compressor Oil: ND-OIL 12 or equivalent

- c. Install the **NEW** O-ring to the No. 1 cooler refrigerant discharge hose.

NOTICE: Keep the **NEW** O-ring and O-ring fitting surface free of foreign matter.

- d. Install the No. 1 cooler refrigerant discharge hose to the compressor with magnet clutch with the bolt.

Torque: 9.8 N·m {100 kgf·cm, 87 in·lbf}

NOTICE: Make sure not to cut the O-ring while installing it. (Cut O-rings cannot be installed.)

- e. Connect the connector.

22. CONNECT SUCTION HOSE SUB-ASSEMBLY



- a. Remove the vinyl tape from the suction hose sub-assembly and connecting part of the compressor with magnet clutch and then sufficiently apply compressor oil to a **NEW** O-ring and the fitting surface of the suction hose sub-assembly.

Compressor Oil: ND-OIL 12 or equivalent

- a. Install the **NEW** O-ring to the suction hose sub-assembly.

NOTICE: Keep the O-ring and O-ring fitting surface free of foreign matter.

- b. Install the suction hose sub-assembly to the compressor with magnet clutch with the bolt.

Torque: 9.8 N·m {100 kgf·cm, 87 in·lbf}

NOTICE: Make sure not to cut the O-ring while installing it. (Cut O-rings cannot be installed.)

23. REMOVE SERVICE ENGINE HOOKS/BOLTS FROM NEW ENGINE

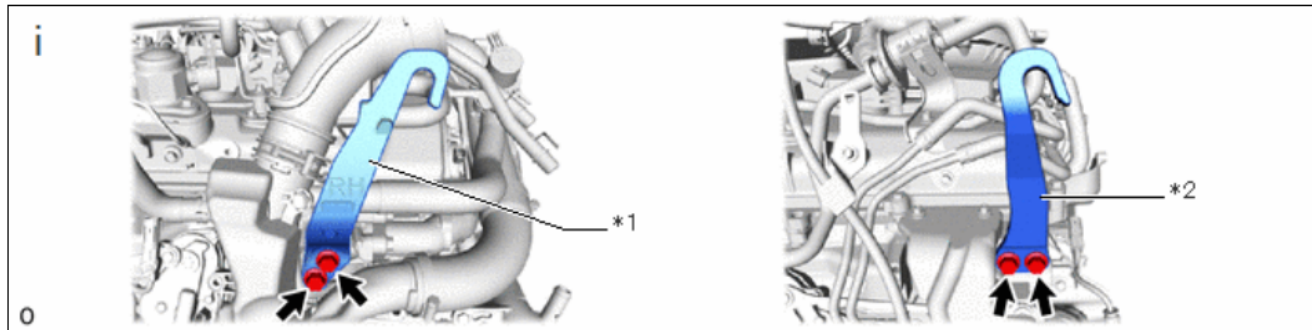

*1	No. 1 Engine Hanger	*2	No. 2 Engine Hanger
----	---------------------	----	---------------------

NOTE: DO NOT DISCARD ENGINE HOOKS OR BOLTS.

- a. Remove the No. 1 engine hanger and No. 2 engine hanger with the 4 bolts as shown in the illustration.

24. CONNECT ENGINE WIRE

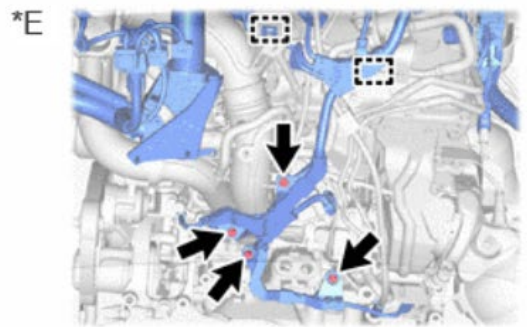
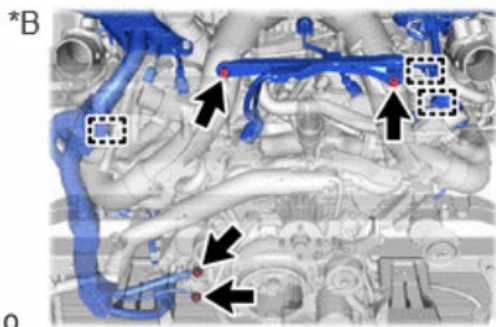
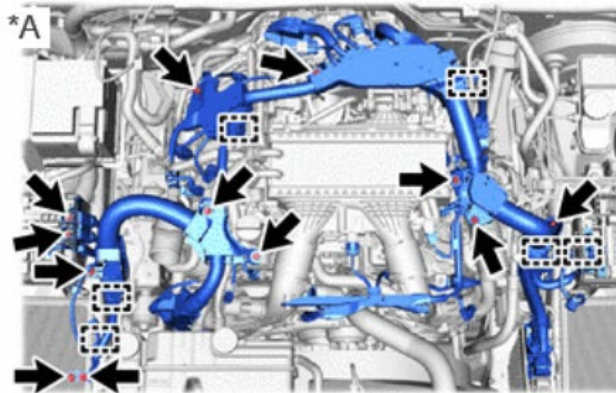
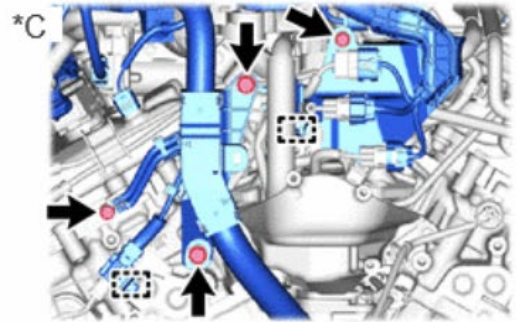
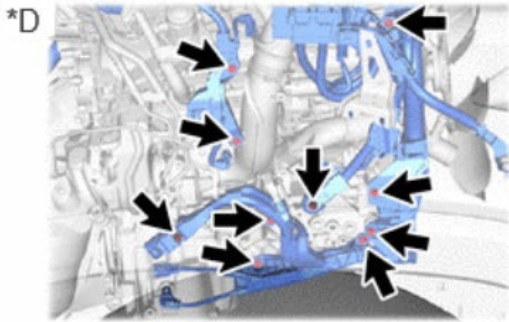

*A	for Upper Side	*B	for Front Side
*C	for Rear Side	*D	for RH Side
*E	for LH Side	-	-



Ensure all ground locations are properly secured, or severe damage may occur to engine as shown below.



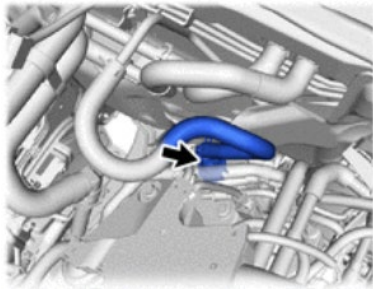



25. CONNECT NO. 1 VACUUM HOSE CONNECTOR

- b. Align the No. 1 vacuum hose connector with the vacuum pump assembly, and push them together until the No. 1 vacuum hose connector makes a "click" sound.

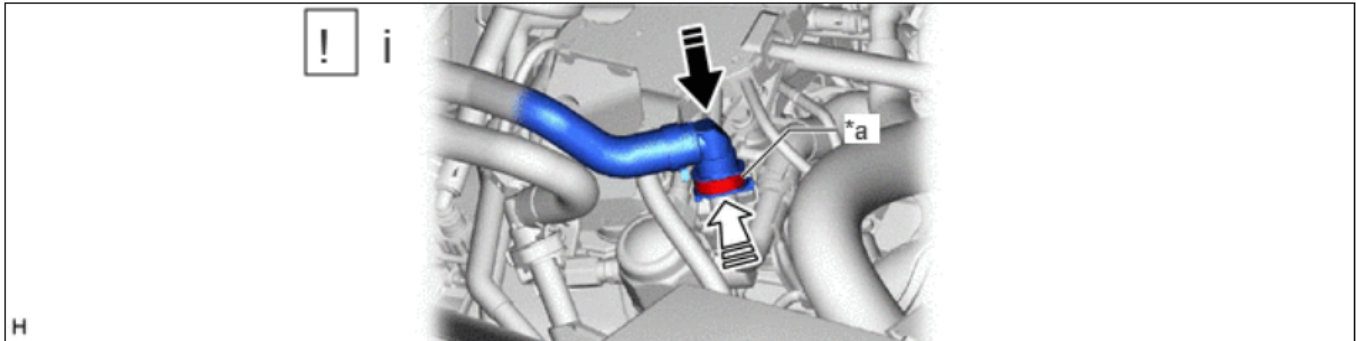
26. CONNECT OUTLET HEATER WATER HOSE B



*a	Retainer	-	-
	Push		Push in

NOTE: Check that there is no damage or foreign matter on the connecting parts of the water lines.

- a. Connect the outlet heater water hose B connector to the No. 4 water by-pass pipe as shown in the illustration.
- b. Push in the retainer.
- c. Check that the No. 4 water by-pass pipe and outlet heater water hose B are securely connected by pulling on them.

27. CONNECT HEATER WATER HOSE L

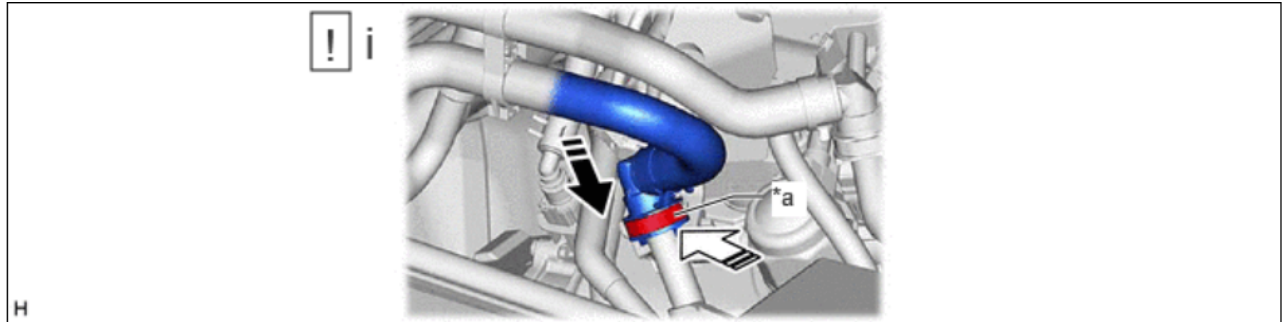

*a	Retainer	-	-
	Push		Push in

NOTE: Check that there is no damage or foreign matter on the connecting parts of the water lines.

- a. Connect the heater water hose L connector to the water by-pass pipe as shown in the illustration.
- b. Push in the retainer.
- c. Check that the No. 4 water by-pass pipe and outlet heater water hose B are securely connected by pulling on them.

28. CONNECT NO. 4 WATER BY-PASS HOSE

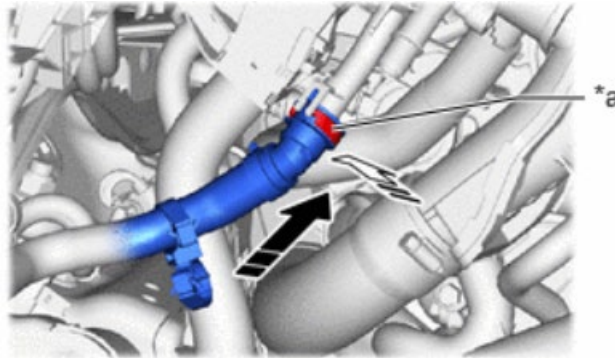

*a	Retainer	-	-
	Push		Push in

- c. Connect the No. 4 water by-pass hose assembly connector to the water by-pass hose assembly.

NOTE: Check that there is no damage or foreign matter on the connecting parts of the water lines.

- d. Align the protrusion of the water by-pass pipe assembly with the cutout in the No. 4 water by-pass hose assembly connector and securely insert the No. 4 water by-pass hose assembly connector to the stopper of the pipe.
- e. Push in the retainer.
- f. Check that the water by-pass pipe assembly and No. 4 water by-pass hose assembly connector are securely connected by pulling on them.

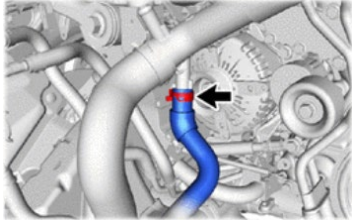

29. CONNECT NO. 3 WATER BY-PASS HOSE

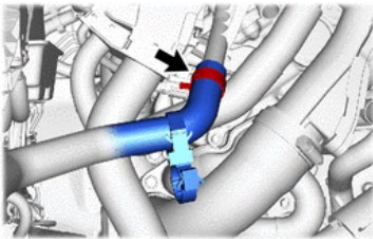

30. CONNECT NO. 4 WATER BY-PASS HOSE

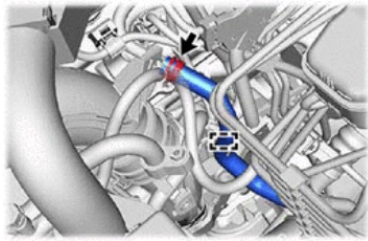

31. CONNECT NO. 1 FUEL VAPOR FEED HOSE

32. INSTALL FAN SHROUD

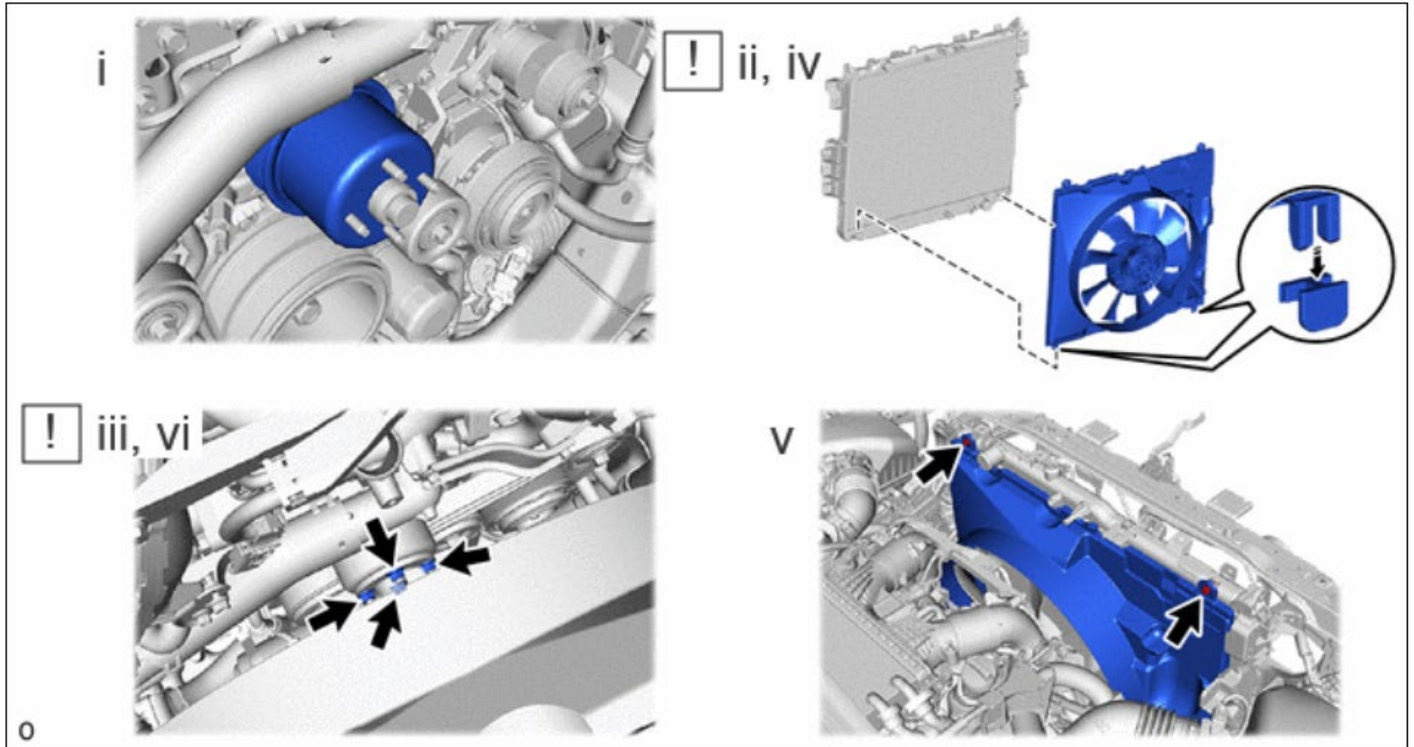

- a. Install the fan pulley to the engine water pump assembly.
- b. Place the fan shroud together with the fluid coupling assembly with fan between the radiator and engine.

NOTE: Be careful not to damage the radiator core.

- c. Temporarily install the fluid coupling assembly with fan to the engine water pump assembly with the 4 nuts. Tighten the nuts as much as possible by hand.
- d. Attach the claws of the fan shroud to the radiator as shown in the illustration.
- e. Install the fan shroud with the 2 bolts.

Torque: 6.5 N·m {66 kgf·cm, 58 in·lbf}



- f. Tighten the 4 nuts of the fluid coupling assembly with fan.

Torque: 21 N·m {214 kgf·cm, 15 ft·lbf}

33. INSTALL FAN AND GENERATOR V BELT

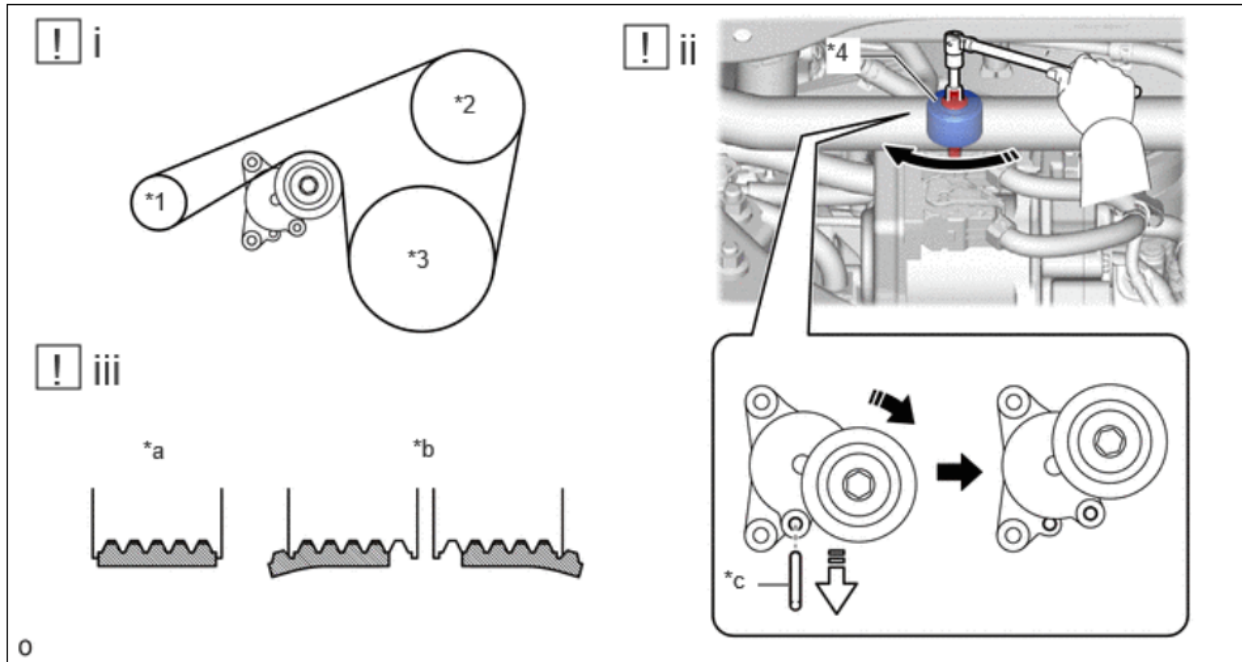
NOTE: When re-using the fan and generator V belt, check the entire circumference of the belt for wear and cracks on the ribs and rear side. Replace belts where wear and cracks have advanced to the wire core and belts with missing rib rubber.



*1	Generator Assembly	*2	Water Pump Assembly
*3	Crankshaft Pulley	*4	V-ribbed Belt Tensioner Assembly
*a	Correct	*b	Incorrect
*c	5 mm Hexagon Wrench	-	-
	Turn in this Direction		Remove the 5 mm hexagon wrench

- Set the fan and generator V belt onto each part.
- Rotate the V-ribbed belt tensioner assembly clockwise, and then remove the 5 mm hexagon wrench.



NOTE: Make sure that the fan and generator V belt is properly installed to each pulley.

- Check that the belt fits properly in the ribbed grooves.

34. INSTALL NO. 1 V BELT (COOLER COMPRESSOR TO CRANKSHAFT PULLEY)

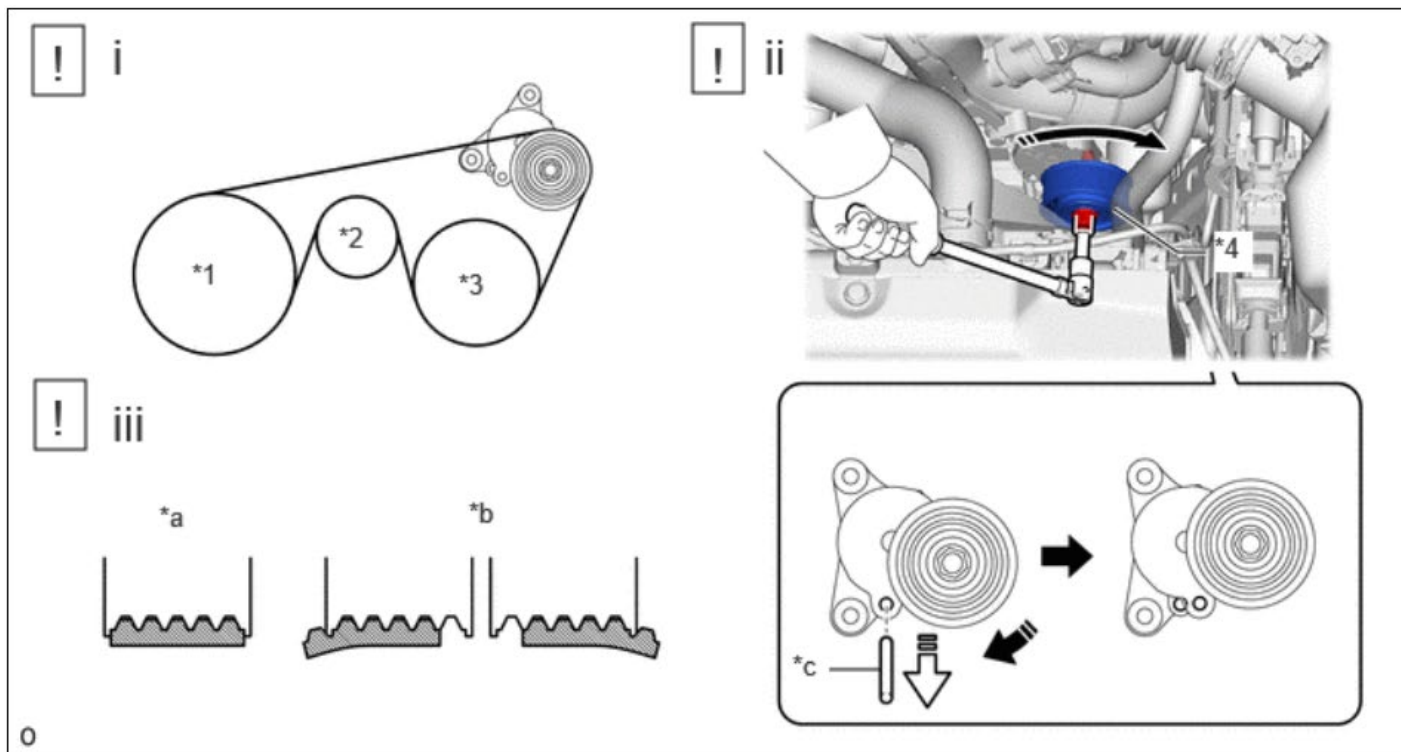
NOTE: When re-using the No. 1 V belt (cooler compressor to crankshaft pulley), check the entire circumference of the belt for wear and cracks on the ribs and rear side. Replace belts where wear and cracks have advanced to the wire core and belts with missing rib rubber.



*1	Crankshaft Pulley	*2	No. 2 Idler Pulley Sub-assembly
*3	Compressor Assembly with Pulley	*4	V-ribbed Belt Tensioner Assembly
*a	Correct	*b	Incorrect
*c	5 mm Hexagon Wrench	-	-
	Turn in this Direction		Remove the 5 mm hexagon wrench

- Set the No. 1 V belt (cooler compressor to crankshaft pulley) onto each part.
- Rotate the V-ribbed belt tensioner assembly clockwise, and then remove the 5 mm hexagon wrench.

NOTE: Make sure that the No. 1 V belt (cooler compressor to crankshaft pulley) is properly installed to each pulley.

Check that the belt fits properly in the ribbed grooves.

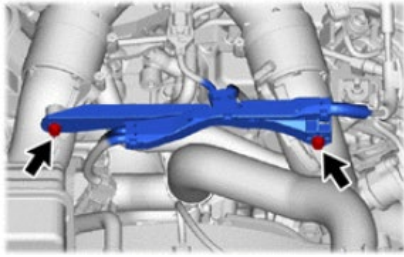

35. CONNECT ENGINE WIRE

Torque: 10 N·m {102 kgf·cm, 7 ft·lbf}

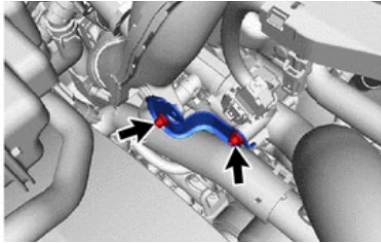



36. INSTALL NO. 1 AIR TUBE SUPPORT

Torque: 10 N·m {102 kgf·cm, 7 ft·lbf}

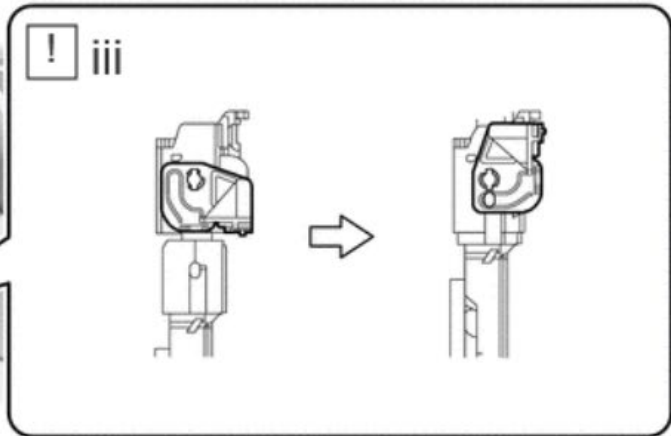
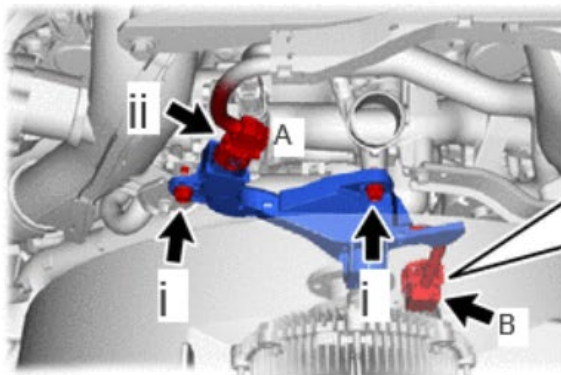
37. INSTALL COOLING FAN WIRE



*1	Crankshaft Pulley	*2	No. 2 Idler Pulley Sub-assembly
*3	Compressor Assembly with Pulley	*4	V-ribbed Belt Tensioner Assembly
*a	Correct	*b	Incorrect
*c	5 mm Hexagon Wrench	-	-
	Turn in this Direction		Remove the 5 mm hexagon wrench

a. Install the cooling fan wire with the 2 bolts.

Torque: 10 N·m {102 kgf·cm, 7 ft·lbf}

- b. Connect the connector A.
- c. Connect connector B and lock it with the lever.

NOTE: When connecting the connectors, make sure that dirt, water or other foreign matter does not become stuck between the connectors and other parts. Make sure that the lever are securely locked.

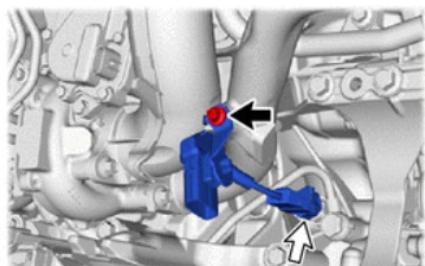

38. CONNECT NO. 10 ENGINE WIRE

Torque: 10 N·m {102 kgf·cm, 7 ft·lbf}

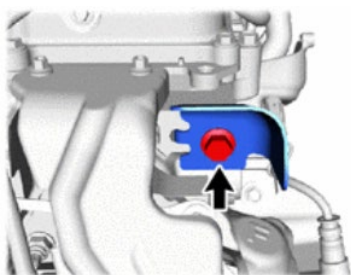

39. INSTALL NO. 6 TURBO INSULATOR

Torque: 25 N·m {255 kgf·cm, 18 ft·lbf}

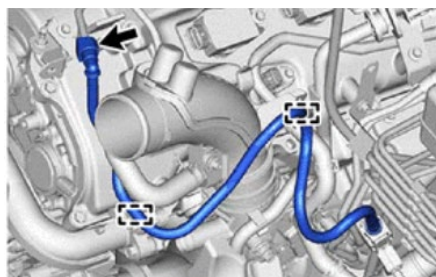

40. INSTALL FUEL TUBE SUB-ASSEMBLY

- a. Connect the fuel tube sub-assembly.
- b. Attach the 2 clamps and install the fuel tube sub-assembly.

41. CONNECT FUEL TUBE SUB-ASSEMBLY

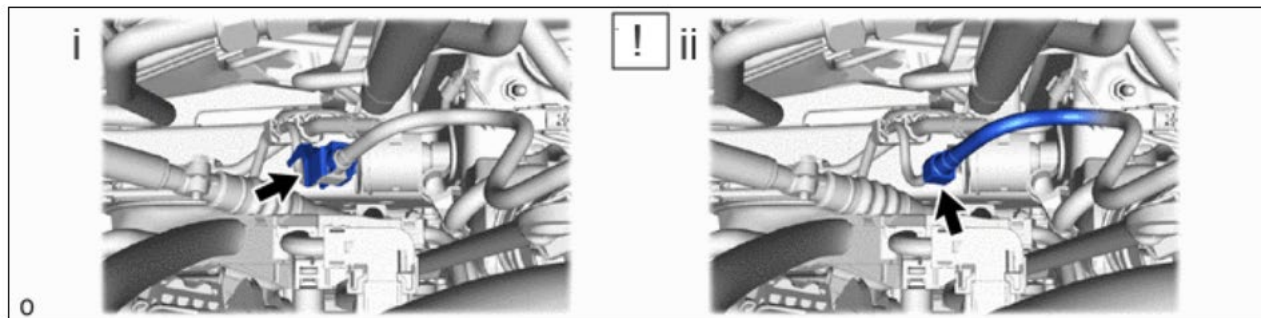

- a. Connect the fuel tube sub-assembly.
- b. Install the fuel pipe clamp.

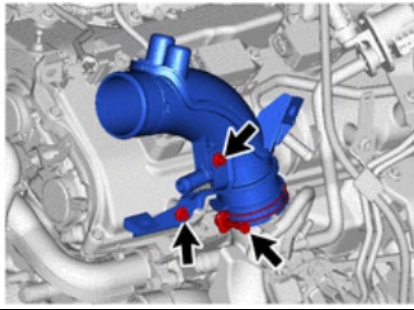

42. INSTALL NO. 2 AIR INLET DUCT

Torque:

bolt: 10 N·m {102 kgf·cm, 7 ft·lbf}

hose clamp: 4.0 N·m {41 kgf·cm, 35 in·lbf}

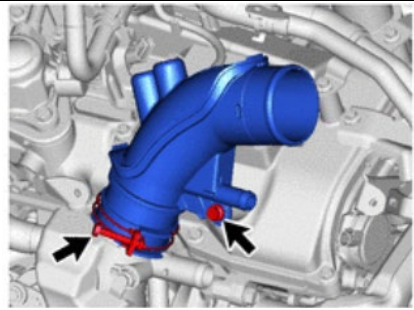

43. INSTALL NO. 1 AIR INLET DUCT

Torque:

bolt: 10 N·m {102 kgf·cm, 7 ft·lbf}

hose clamp: 4.0 N·m {41 kgf·cm, 35 in·lbf}

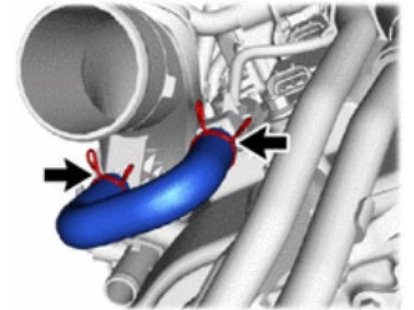

44. INSTALL NO. 2 PCV HOSE LH (NO. 2 VENTILATION HOSE)

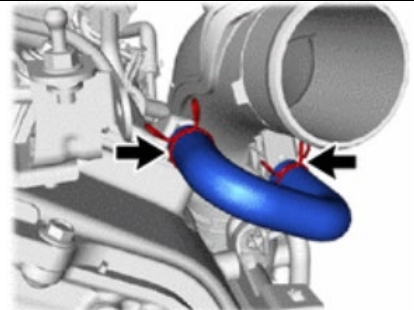

45. INSTALL NO. 2 PCV HOSE RH (NO. 2 VENTILATION HOSE)

46. CONNECT ENGINE WIRE

NOTE: After disconnecting the wire harness, secure it with tape or equivalent to keep it out of the way.

*A

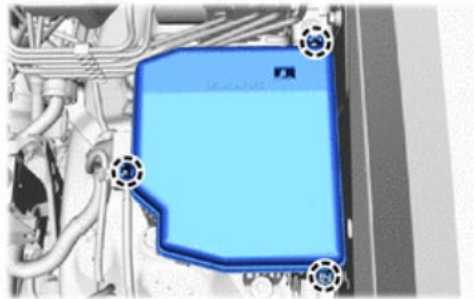
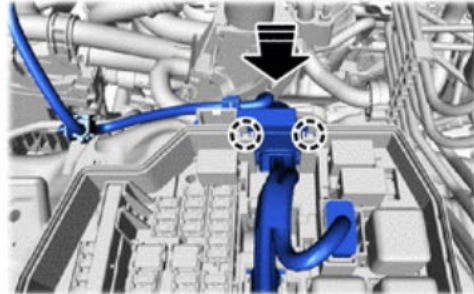
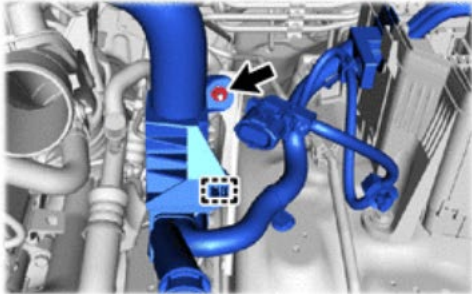



0

*A	for LH Side	-	-
----	-------------	---	---

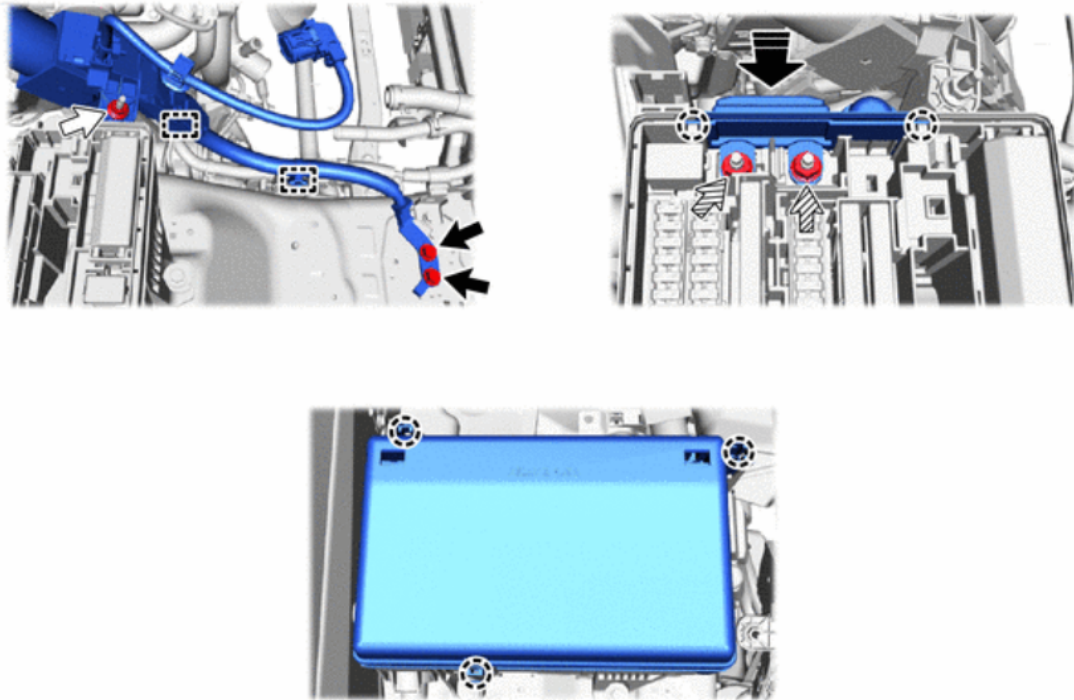
*A



0

*A	for RH Side	-	-
	Bolt		Nut A
	Nut B	-	-

Torque:
for bolt :
20 N·m {204 kgf·cm, 15 ft·lbf}
for nut A :
10 N·m {102 kgf·cm, 7 ft·lbf}
for nut B :
8.0 N·m {82 kgf·cm, 71 in·lbf}

47. CONNECT ECM

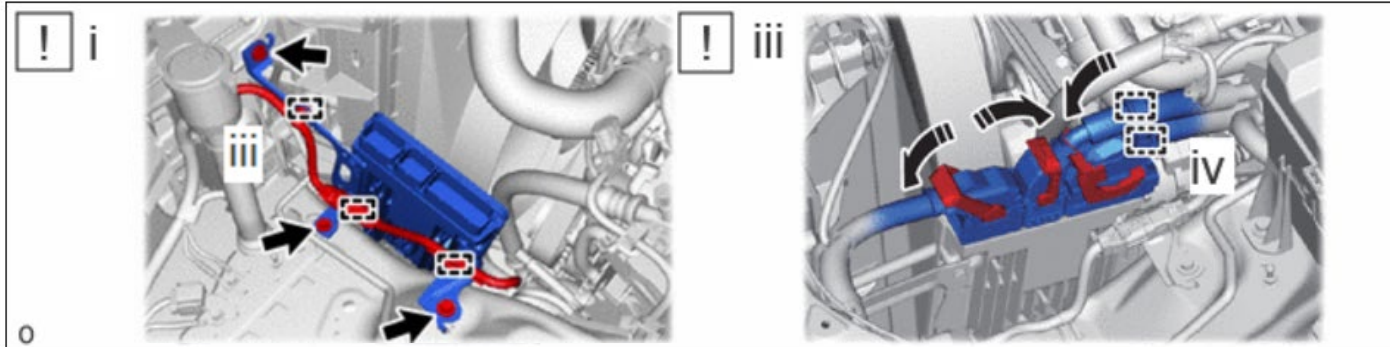

- a. Install the ECM with the 3 bolts.

Torque: 13 N·m {133 kgf·cm, 10 ft·lbf}

NOTE: If the ECM has been struck or dropped, replace it.

- b. Attach the 2 wire harness clamps.
 c. Connect the 3 connectors to the ECM and push down the lever to lock it.
 d. Attach the 2 wire connector clamps.

48. INSTALL AIR CLEANER ASSEMBLY LH WITH AIR CLEANER HOSE ASSEMBLY LH

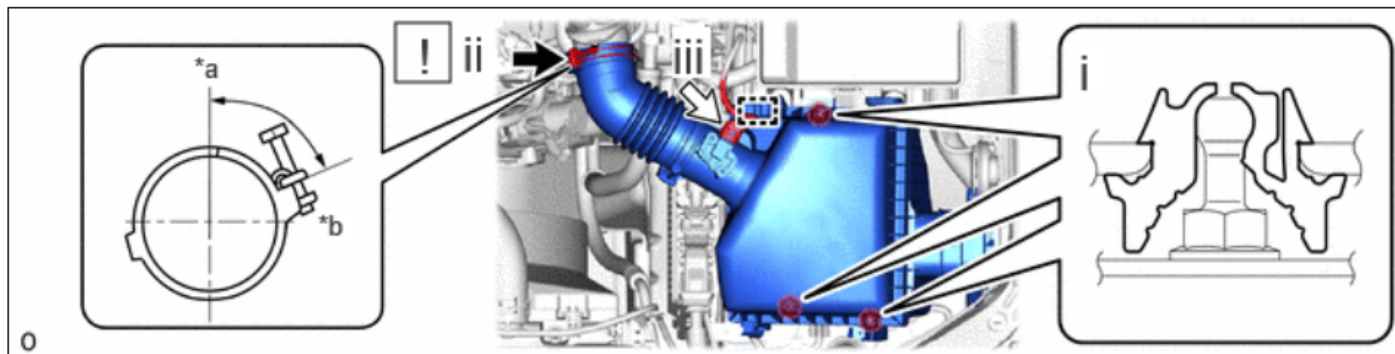

*a	Upper Side	*b	RH Side
----	------------	----	---------

- a. Attach the 3 grommets to install the air cleaner assembly LH with air cleaner hose assembly LH.
 b. Tighten the hose clamp in the position shown in the illustration.

Torque: 2.8 N·m {29 kgf·cm, 25 in·lbf}

NOTE: Make sure that the clamp bolt of the hose clamp are within the area shown in the illustration.

- c. Attach the clamp and connect the connector.

49. INSTALL AIR CLEANER ASSEMBLY RH WITH AIR CLEANER HOSE ASSEMBLY RH

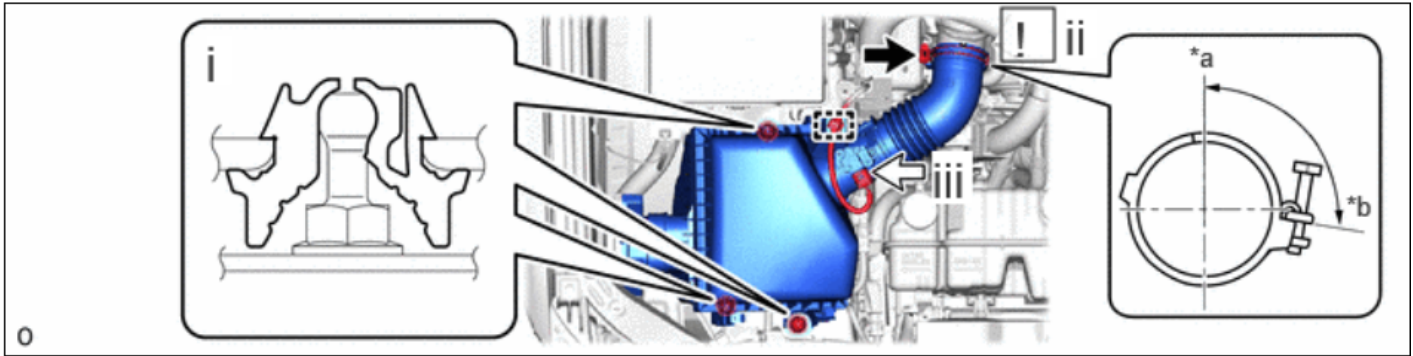

*a	Upper Side	*b	RH Side
----	------------	----	---------

- a. Attach the 3 grommets to install the air cleaner assembly RH with air cleaner hose assembly RH.
- b. Tighten the hose clamp in the position shown in the illustration.

Torque: 2.8 N·m {29 kgf·cm, 25 in·lbf}

NOTE: Make sure that the clamp bolt of the hose clamp are within the area shown in the illustration.

- c. Attach the clamp and connect the connector.

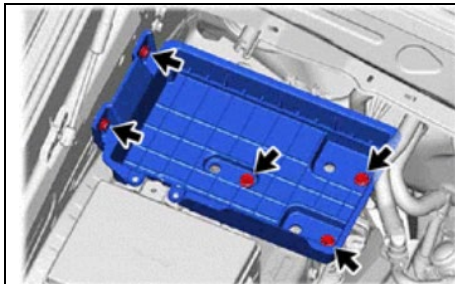

50. INSTALL BATTERY AND BATTERY CARRIER ASSEMBLY

Torque: 21 N·m {214 kgf·cm, 15 ft·lbf}

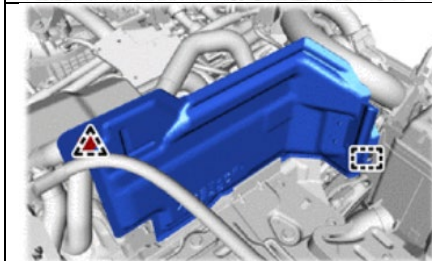

51. INSTALL ENGINE SIDE UNDER COVER RH

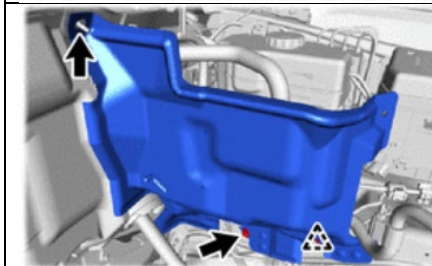

52. INSTALL REAR ENGINE SIDE UNDER COVER ASSEMBLY LH

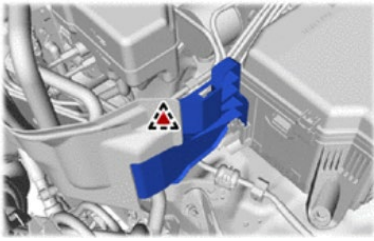

53. INSTALL UPPER ENGINE SIDE UNDER COVER PLATE LH

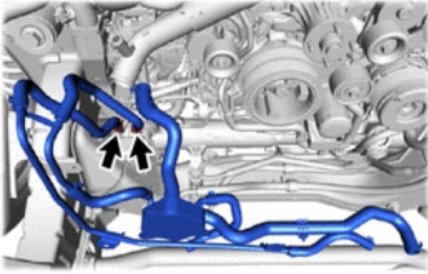

54. INSTALL OIL COOLER TUBE AND OIL COOLER HOSE WITH OIL COOLER ASSEMBLY

55. CONNECT OIL COOLER TUBE SUB-ASSEMBLY

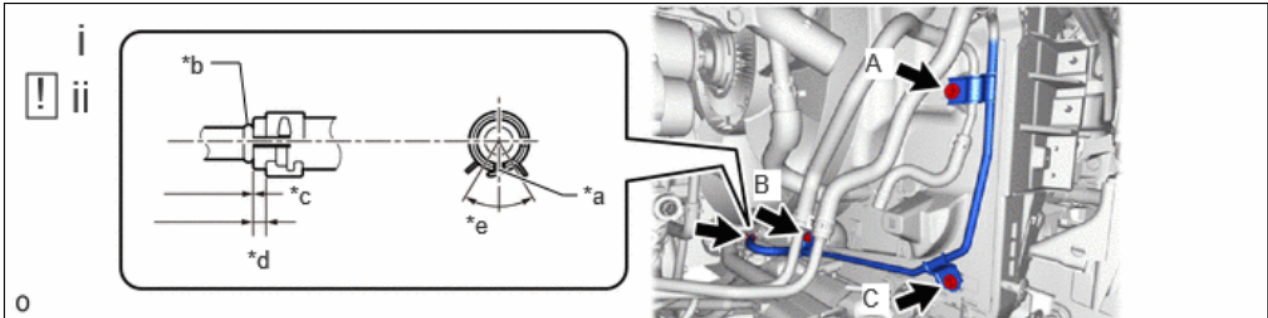

*a	Paint Mark	*b	Stopper
*c	-1.5 to 1.5 mm (-0.0591 to 0.0591 in.)	*d	2.0 to 7.0 mm (0.0787 to 0.276 in.)
*e	60°	-	-

- a. Connect the oil cooler tube sub-assembly to the fan shroud with the 3 bolts.

Torque: 5.5 N·m {56 kgf·cm, 49 in·lbf}

NOTE: Tightening order: Temporarily install bolt A → Tighten bolt B → Tighten bolt C → Tighten bolt A

- b. Connect the oil cooler tube sub-assembly to the radiator assembly and slide the hose clip to secure it as shown in the illustration.

NOTE: Make sure the oil cooler tube sub-assembly is securely inserted to the stopper.

56. CONNECT OIL COOLER ASSEMBLY WITH OIL COOLER HOSE

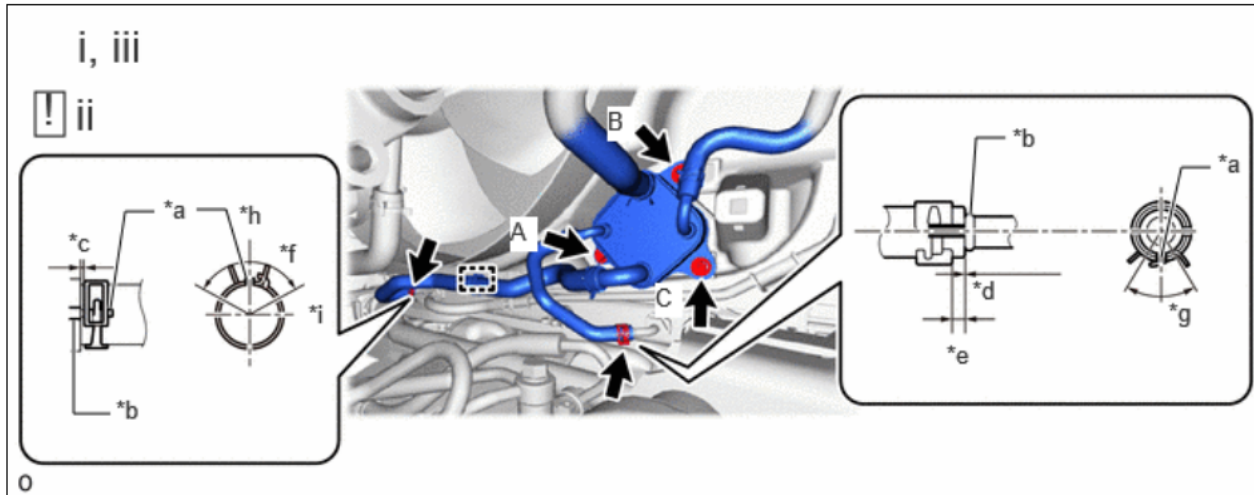

*a	Paint Mark	*b	Stopper
*c	2.0 to 5.0 mm (0.0787 to 0.197 in.)	*d	-1.5 to 1.5 mm (-0.0591 to 0.0591 in.)
*e	2.0 to 7.0 mm (0.0787 to 0.276 in.)	*f	120°
*g	60°	*h	Upper Side
*i	RH Side	-	-

a. Connect the oil cooler assembly with oil cooler hose to the fan shroud with the 3 bolts.

Torque: 5.5 N·m {56 kgf·cm, 49 in·lbf}

NOTE: Tightening order: Tighten bolt A → Tighten bolt B → Tighten bolt C

b. Connect the oil cooler assembly with oil cooler hose to the radiator assembly and slide the 2 hose clips to secure it as shown in the illustration.

NOTE: Install so that the paint mark and positioning stopper are securely overlapped. Make sure the oil cooler assembly with oil cooler hose is securely inserted to the stopper.

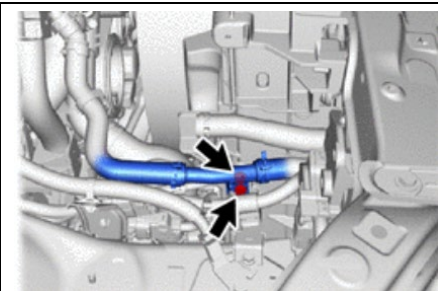

57. CONNECT NO. 2 WATER BY-PASS PIPE

Torque: 5.0 N·m {51 kgf·cm, 44 in·lbf}

58. CONNECT NO. 2 RADIATOR HOSE

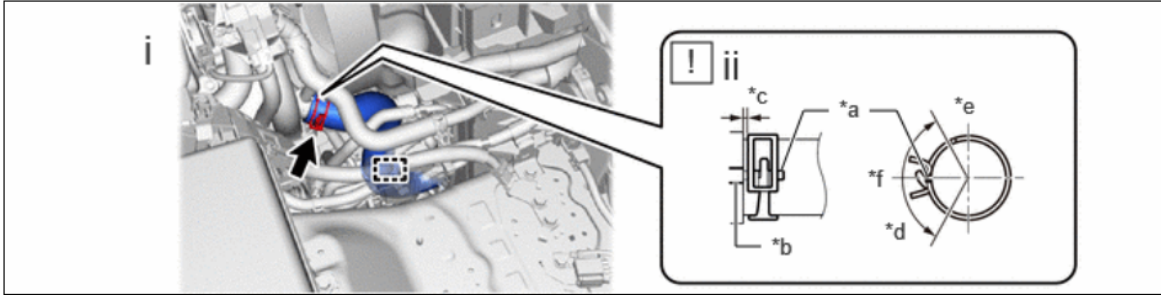

*a	Paint Mark	*b	Stopper
*c	2.0 to 7.0 mm (0.0787 to 0.276 in.)	*d	120°
*e	Upper Side	*f	RH Side

- a. Attach the clamp.
- b. Connect the No. 2 radiator hose to the water inlet pipe and slide the hose clip to secure it as shown in the illustration.

NOTE: Install so that the paint mark and positioning stopper are securely overlapped.

NOTE: Make sure the No. 2 radiator hose is securely inserted to the stopper.

59. CONNECT NO. 1 RADIATOR HOSE

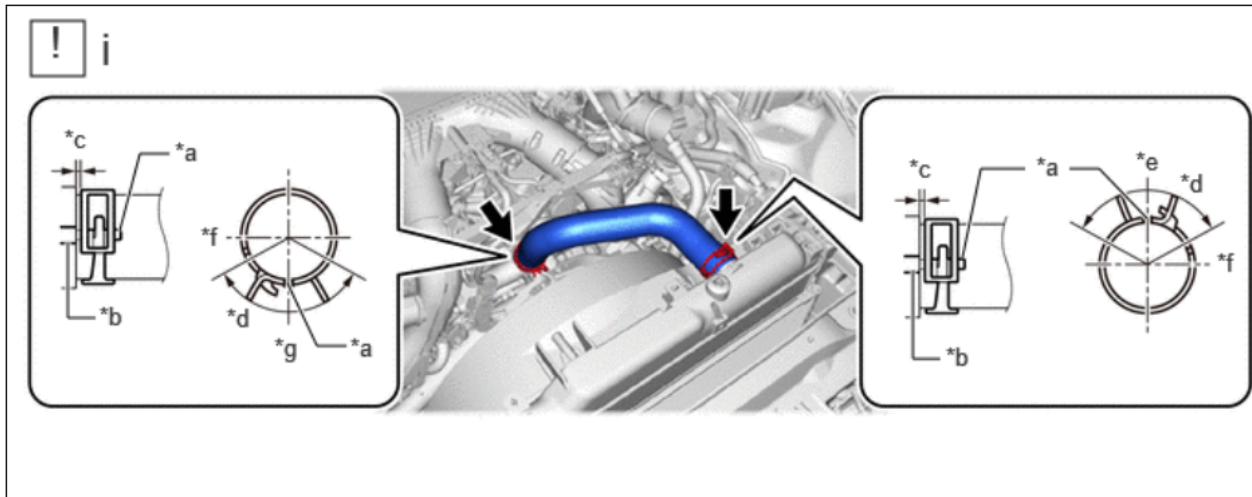

*a	Paint Mark	*b	Stopper
*c	2.0 to 5.0 mm (0.0787 to 0.197 in.)	*d	120°
*e	Upper Side	*f	RH Side
*g	Front Side	-	-

- a. Install the No. 1 radiator hose to the water outlet pipe and radiator assembly and slide the 2 hose clips to secure it as shown in the illustration.

NOTE: Install so that the paint mark and positioning stopper are securely overlapped.

NOTE: Make sure the No. 1 radiator hose is securely inserted to the stopper.

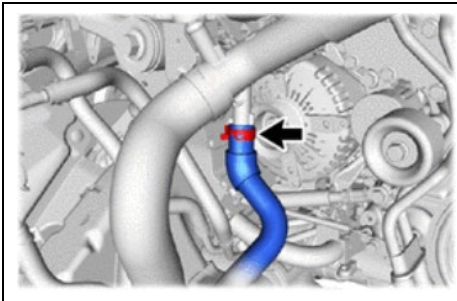

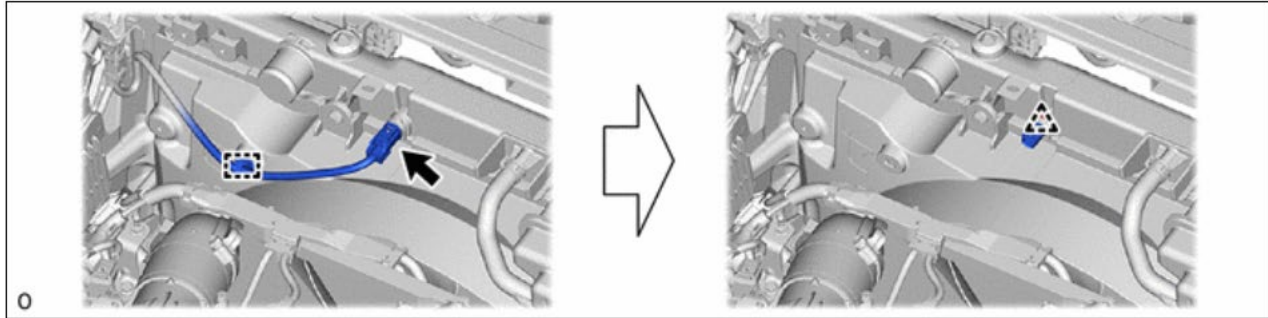

60. CONNECT NO. 3 WATER BY-PASS HOSE

61. CONNECT ENGINE COOLANT TEMPERATURE SENSOR

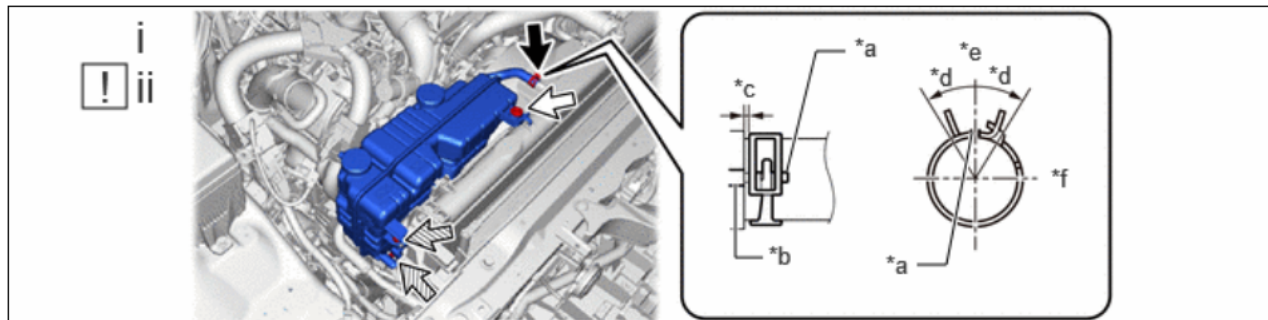

62. INSTALL RADIATOR RESERVE TANK ASSEMBLY



*a	Paint Mark	*b	Stopper
*c	2.0 to 5.0 mm (0.0787 to 0.197 in.)	*d	30°
*e	Upper Side	*f	RH Side
	Bolt A		Bolt B

- a. Install the radiator reserve tank assembly to the radiator assembly with the 3 bolts.

Torque: 7.0 N·m {71 kgf·cm, 62 in·lbf}

- b. Connect the radiator reserve tank hose to the radiator assembly and slide the hose clip to secure it as shown in the illustration.

NOTE: Install so that the paint mark and positioning stopper are securely overlapped.

NOTE: Make sure the radiator reserve tank hose is securely inserted to the stopper.

63. CONNECT NO. 2 WATER BY-PASS HOSE

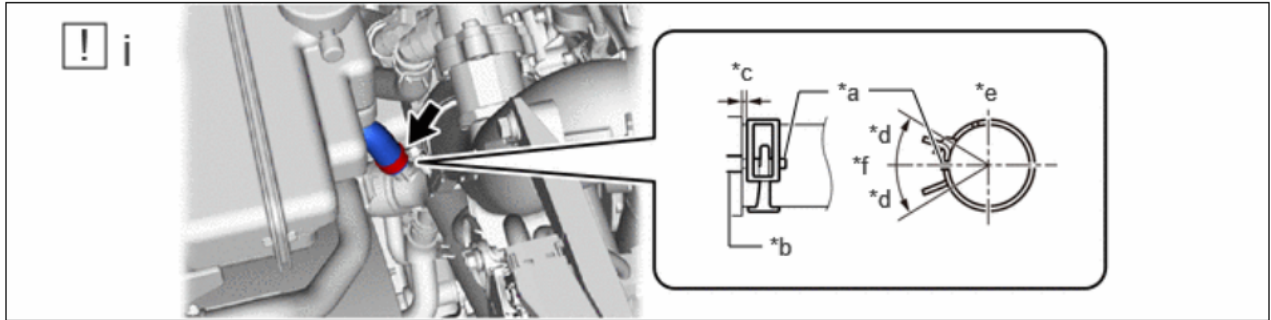

*a	Paint Mark	*b	Stopper
*c	2.0 to 5.0 mm (0.0787 to 0.197 in.)	*d	25°
*e	Rear Side	*f	RH Side

a. Connect the No. 2 water by-pass hose to the water inlet pipe and slide the hose clip to secure it as shown in the illustration.

NOTE: Install so that the paint mark and positioning stopper are securely overlapped.

NOTE: Make sure the No. 2 water by-pass hose is securely inserted to the stopper.

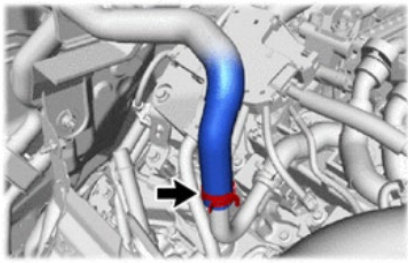

64. CONNECT OUTLET HEATER WATER HOSE

65. CONNECT NO. 2 WATER BY-PASS HOSE

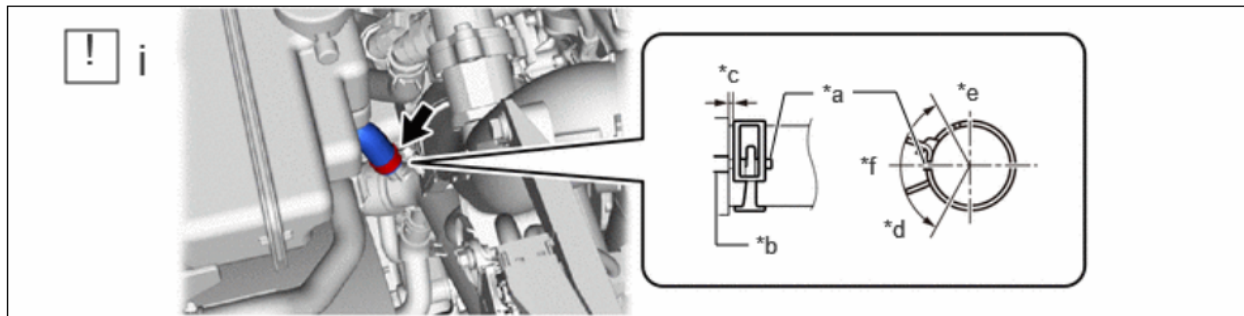

*a	Paint Mark	*b	Stopper
*c	2.0 to 7.0 mm (0.0787 to 0.276 in.)	*d	120°
*e	Rear Side	*f	RH Side

a. Connect the No. 2 water by-pass hose to the water inlet pipe and slide the hose clip to secure it as shown in the illustration.

NOTE: Install so that the paint mark and positioning stopper are securely overlapped.

NOTE: Make sure the No. 2 water by-pass hose is securely inserted to the stopper.

66. CONNECT NO. 3 WATER BY-PASS HOSE

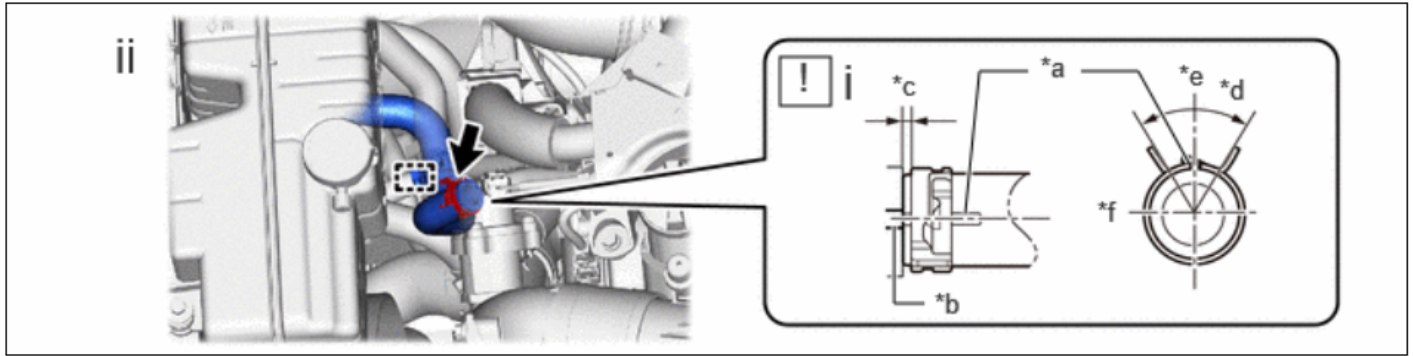

*a	Paint Mark	*b	Stopper
*c	2.0 to 5.0 mm (0.0787 to 0.197 in.)	*d	60°
*e	Upper Side	*f	RH Side

- a. Connect the No. 3 water by-pass hose to the radiator reserve tank assembly and slide the hose clip to secure it as shown in the illustration.

NOTE: Install so that the paint mark and positioning stopper are securely overlapped.

NOTE: Make sure the No. 3 water by-pass hose is securely inserted to the stopper.

- b. Attach the clamp

67. INSTALL COWL TOP VENTILATOR LOUVER SUB-ASSEMBLY

NOTE: To prevent damage to the windshield glass, remove any foreign matter (sand, dust, etc.) from around the contacting surfaces of the cowl top ventilator louver sub-assembly and windshield glass.

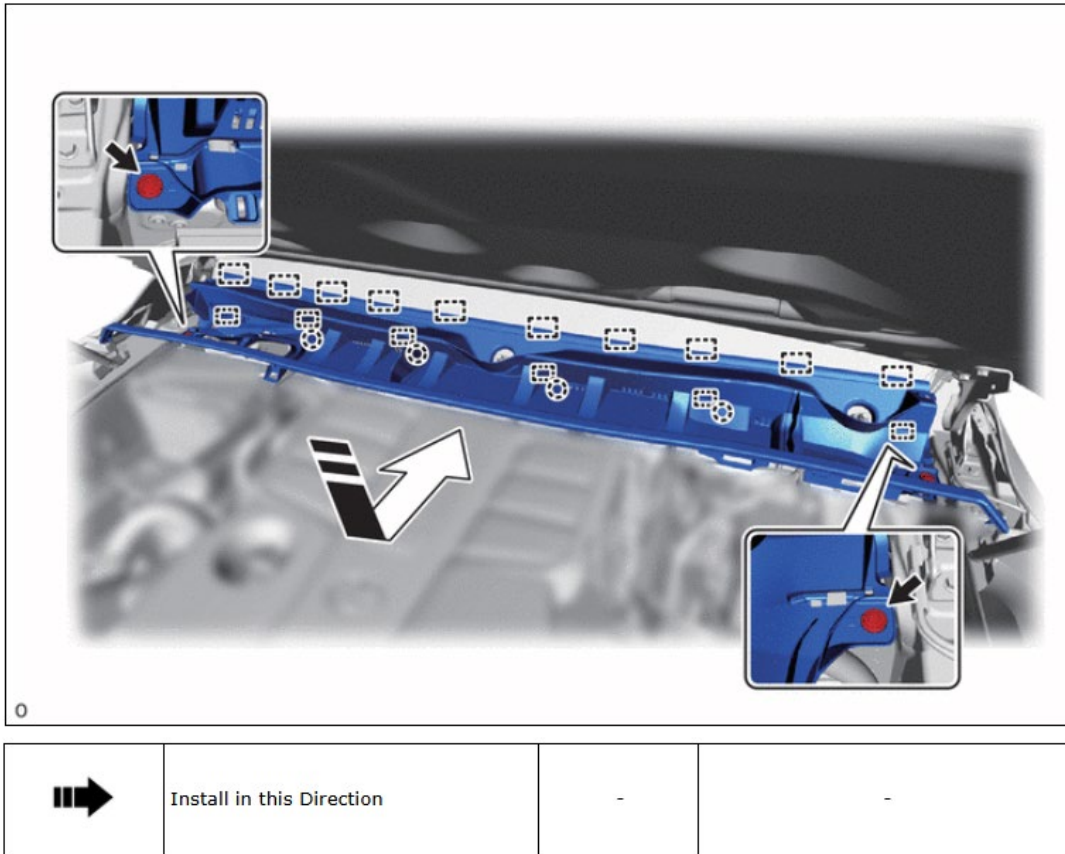

68. INSTALL COWL TOP VENTILATOR LOUVER RH

69. INSTALL COWL TOP VENTILATOR LOUVER LH

70. INSTALL HOOD TO COWL TOP SEAL

71. INSTALL ENGINE SIDE COVER RH

72. INSTALL ENGINE SIDE COVER LH

73. INSTALL WINDSHIELD OUTSIDE MOULDING RH

74. INSTALL WINDSHIELD OUTSIDE MOULDING LH

75. INSTALL FRONT WIPER ARM AND BLADE ASSEMBLY RH

NOTE: To prevent damage to the windshield glass, remove any foreign matter (sand, dust, etc.) from around the contacting surfaces of the cowl top ventilator louver sub-assembly and windshield glass.

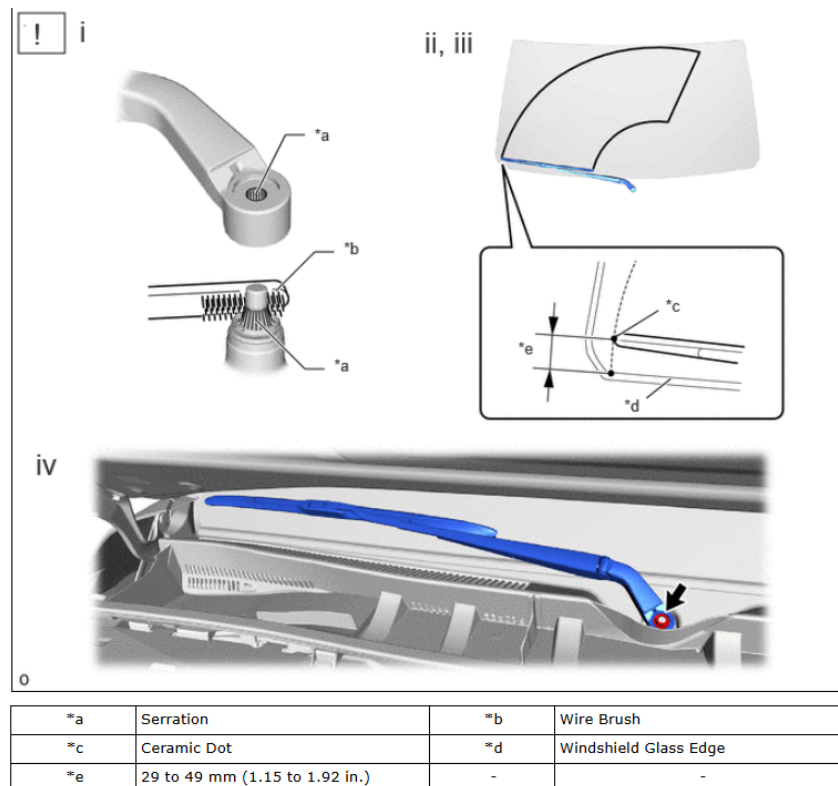

- a. When reusing the front wiper arm and blade assembly RH:
- A. Clean the wiper arm serrations to remove any burrs, dirt, etc.

NOTE: Do not grind down the wiper arm serrations.

- b. Set the automatic stop position by the below procedure.
- A. Turn the ignition switch to ON.
 - B. Operate the windshield wipers while spraying washer fluid onto the windshield glass. Make sure that the windshield wipers function properly and the wipers do not contact the vehicle body.
 - C. Turn the ignition switch off.
- c. Temporarily install the front wiper arm and blade assembly RH with the nut to the position shown in the illustration.

d. Install the front wiper arm and blade assembly RH with the nut to the position shown in the illustration.

Torque: 26 N·m {265 kgf·cm, 19 ft·lbf}

NOTE: Hold the arm hinge by hand when tightening the nut.

76. INSTALL FRONT WIPER ARM AND BLADE ASSEMBLY LH

NOTE: To prevent damage to the windshield glass, remove any foreign matter (sand, dust, etc.) from around the contacting surfaces of the cowl top ventilator louver sub-assembly and windshield glass.

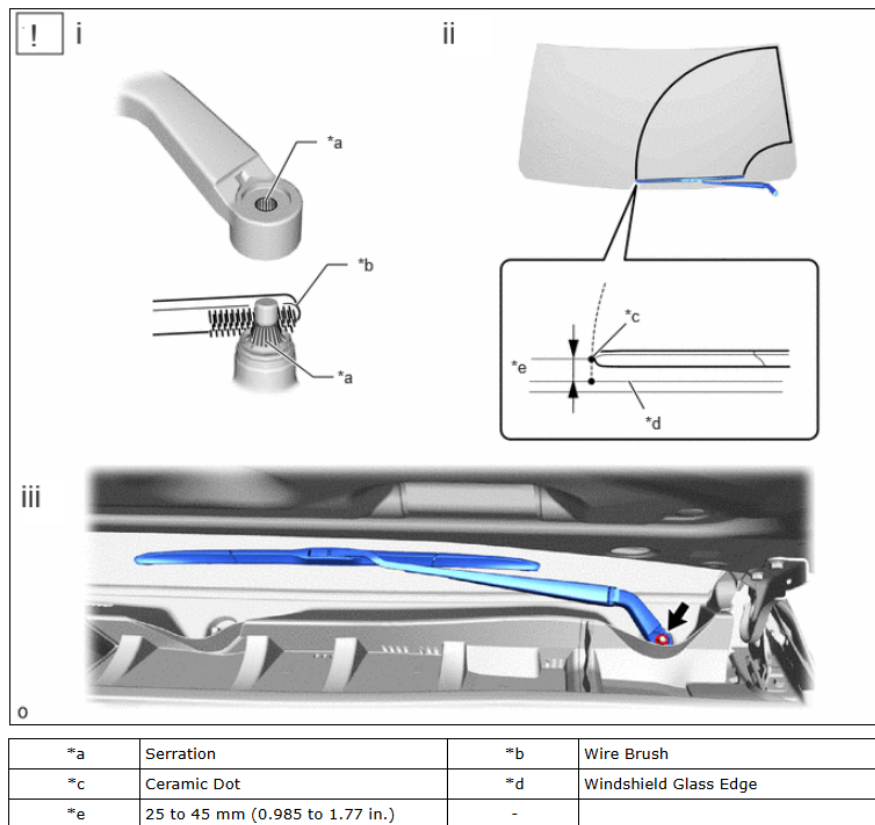

e. When reusing the front wiper arm and blade assembly LH:

A. Clean the wiper arm serrations to remove any burrs, dirt, etc.

NOTE: Do not grind down the wiper arm serrations.

f. Set the automatic stop position by the below procedure.

A. Turn the ignition switch to ON.

B. Operate the windshield wipers while spraying washer fluid onto the windshield glass. Make sure that the windshield wipers function properly and the wipers do not contact the vehicle body.

C. Turn the ignition switch off.

- g. Temporarily install the front wiper arm and blade assembly LH with the nut to the position shown in the illustration.
- h. Install the front wiper arm and blade assembly LH with the nut to the position shown in the illustration.

Torque: 26 N·m {265 kgf·cm, 19 ft·lbf}

NOTE: Hold the arm hinge by hand when tightening the nut.

77. INSTALL FRONT WIPER ARM HEAD CAP

78. INSTALL HOOD SUB-ASSEMBLY

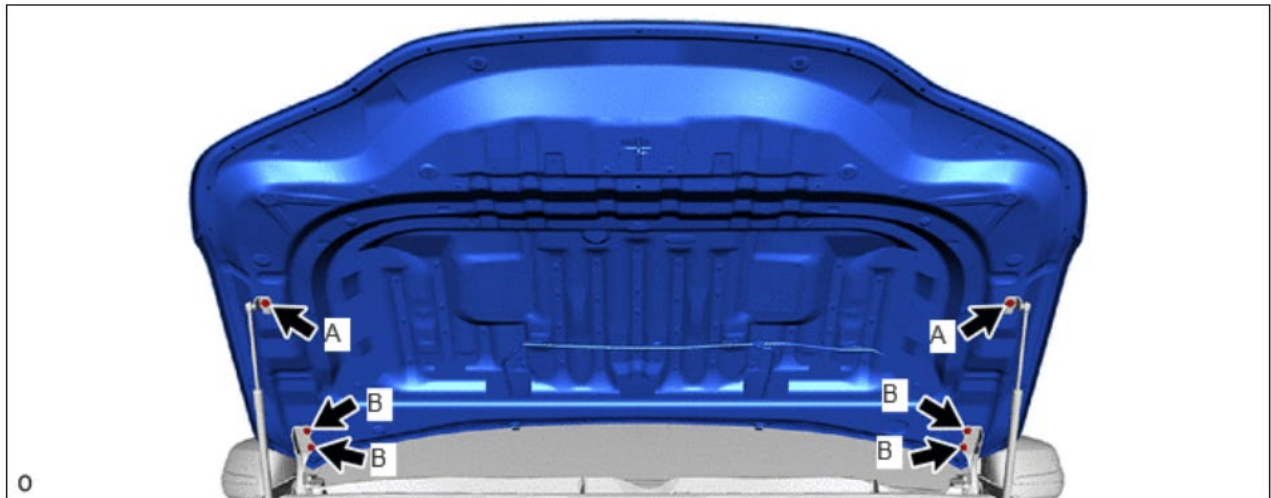

Torque:

for bolt A :

17.5 N·m {178 kgf·cm, 13 ft·lbf}

for bolt B :

13 N·m {133 kgf·cm, 10 ft·lbf}

NOTE: Be sure to perform this procedure with several people as the hood sub-assembly is very heavy.

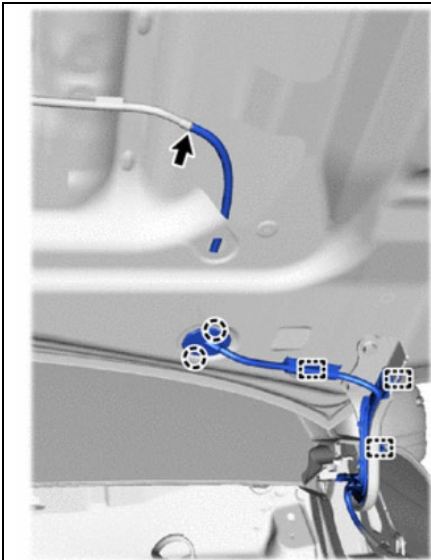

79. CONNECT WINDSHIELD WASHER HOSE ASSEMBLY

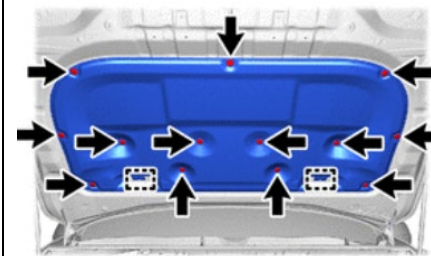

80. INSTALL HOOD INSULATOR

81. INSTALL BATTERY

- e. Install battery
- f. Install battery clamp sub assembly

Torque: 18.5 N·m {189 kgf·cm, 14 ft·lbf}

- g. Install No. 2 Battery Carrier Bracket

Torque: 7.6 N·m {77 kgf·cm, 67 in·lbf}

- h. Connect cable to positive battery terminal

Torque: 4.8 N·m {49 kgf·cm, 42 in·lbf}

- i. Connect cable to negative battery terminal

Torque: 5.4 N·m {55 kgf·cm, 48 in·lbf}

82. INSTALL V-BANK COVER SUB-ASSEMBLY

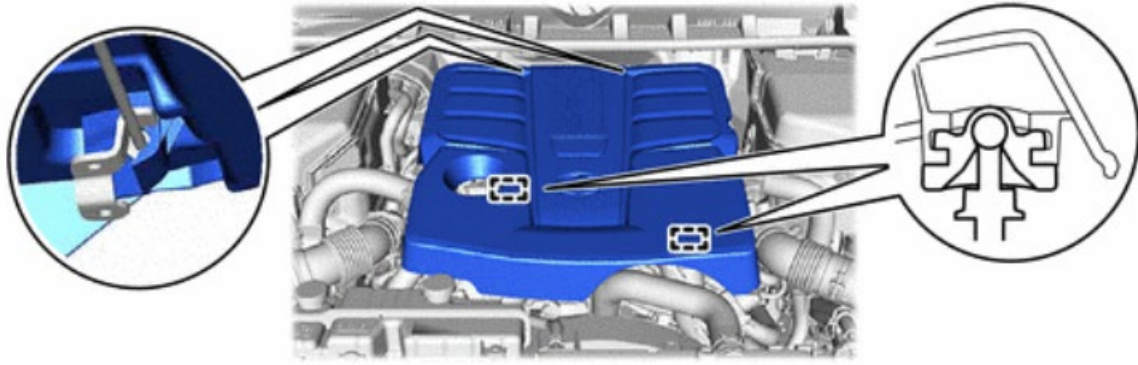

83. INSTALL UPPER RADIATOR SUPPORT SEAL

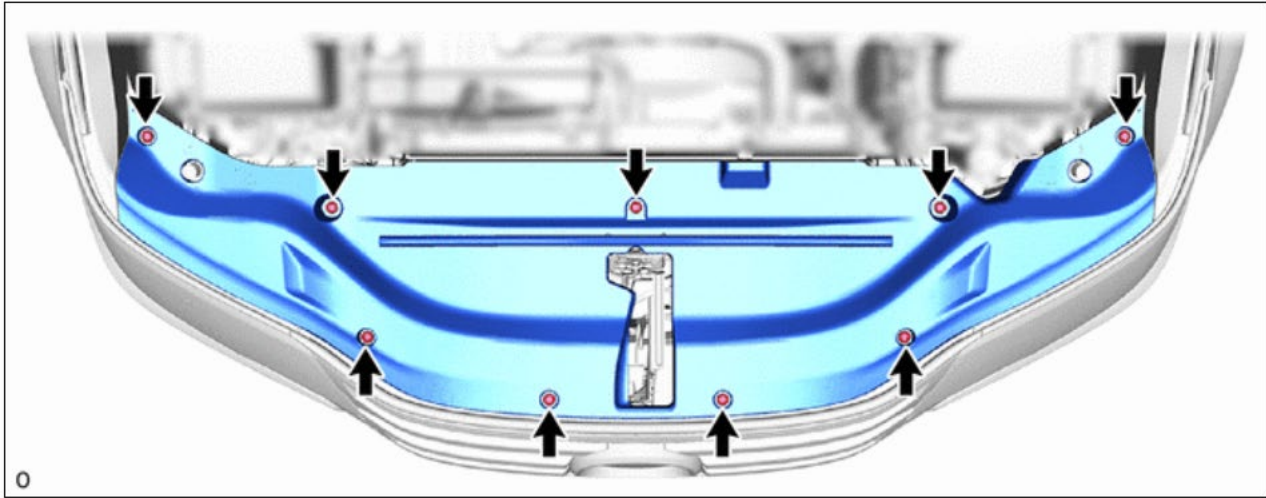

**84. INSTALL FRONT FENDER APRON TRIM PACKING
A**

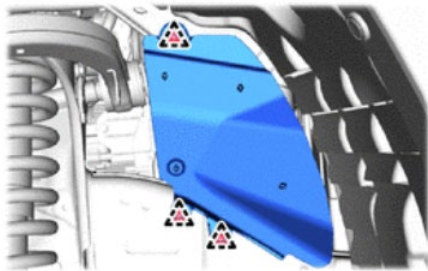

**85. INSTALL FRONT FENDER APRON TRIM PACKING
B**

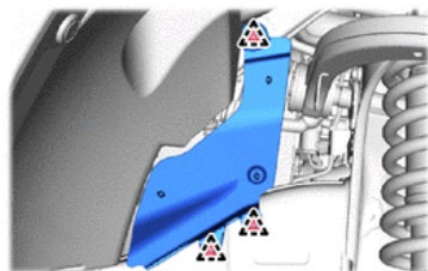

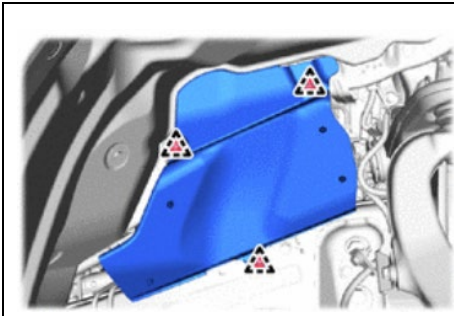

86. INSTALL FRONT FENDER APRON TRIM PACKING C

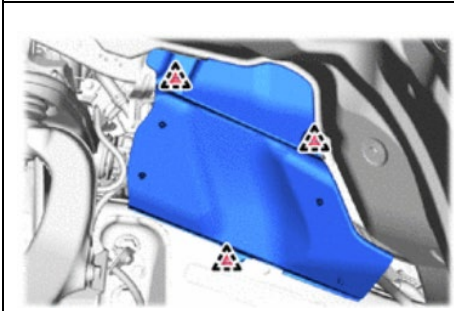

87. INSTALL FRONT FENDER APRON TRIM PACKING D

88. INSTALL FRONT WHEELS

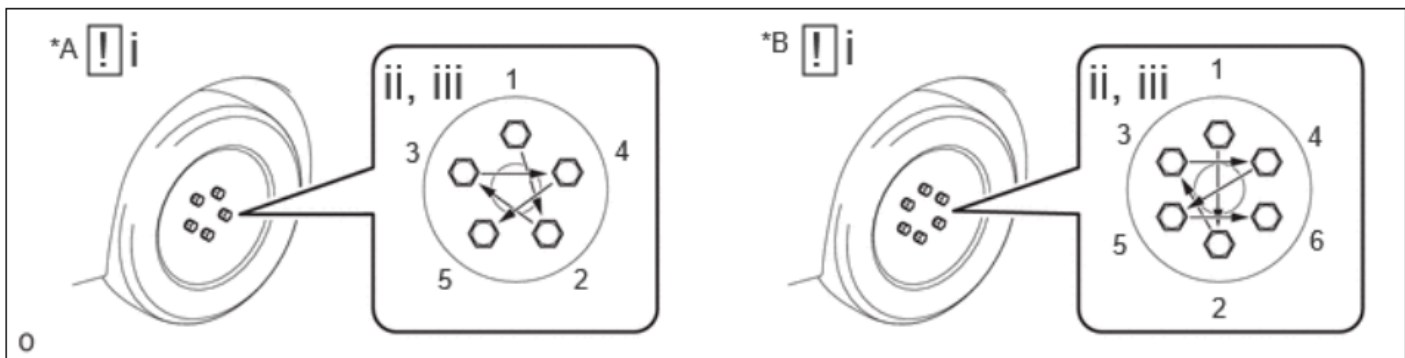

*A	for 5 Bolt Axle Hub	*B	for 6 Bolt Axle Hub
----	---------------------	----	---------------------

- a. While aligning the wheel assembly with the center of the axle hub, install the axle hub nuts by hand.
- b. Temporarily tighten the axle hub nuts in the order shown in the illustration.
- c. Lower the vehicle then fully tighten the axle hub nuts in the order shown in the illustration.

Torque: 131 N·m {1336 kgf·cm, 97 ft·lbf}

89. CHARGE AIR CONDITIONING SYSTEM WITH REFRIGERANT (RM10000001ZTOL)

NOTE: Charge refrigerant in accordance with the equipment manual.

- a. Perform vacuum purging using a vacuum pump or appropriate equipment.

NOTE: Be sure to use a refrigerant recovery unit that is compatible with HFO-1234yf (R1234yf) systems.

- b. Charge the air conditioning system with refrigerant.

Refrigerant Type: HFO-1234yf (R1234yf)

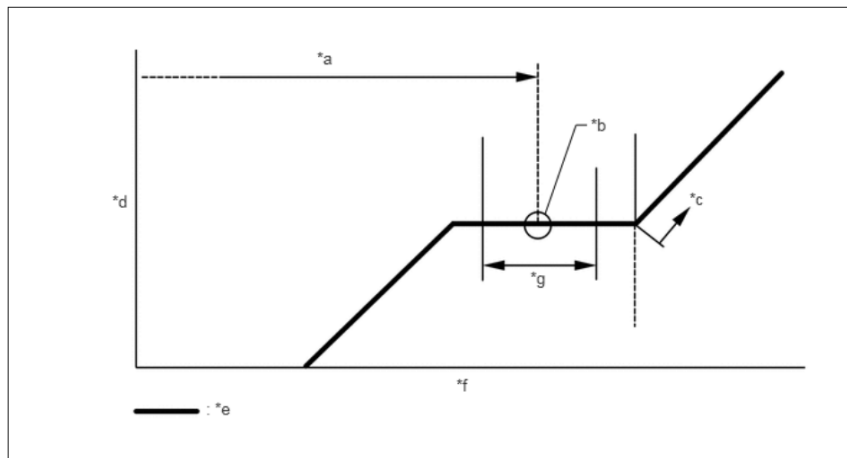

*a	Standard Charge Amount	*b	Mean Value in Proper Range
*c	Overcharged	*d	High Pressure
*e	Sub-cool System	*f	Refrigerant Amount
*g	+/-30 g (+/-1.05 oz)	-	-

COOL BOX	REFRIGERANT CHARGING AMOUNT
w/o Cool Box	920 to 980 g (32.5 to 34.5 oz)
w/ Cool Box	1040 to 1100 g (36.7 to 38.8 oz)

NOTE: Do not turn the A/C switch on before charging the air conditioning system with refrigerant. Doing so may cause the compressor to work without refrigerant, resulting in overheating of the compressor. The refrigerant amount should be checked by quantity (weight). The graph above is shown for reference only.

NOTE: Ensure that sufficient refrigerant is available to recharge the system when using a refrigerant recovery unit. Refrigerant recovery units are not always able to recover 100% of the refrigerant from an air conditioning system.

90. ADD ENGINE COOLANT (RM100000002080B)

NOTE:

- Do not remove the reserve tank cap or drain cock plug while the engine and radiator assembly are still hot. Pressurized, hot engine coolant and steam may be released and cause serious burns.
 - To prevent injury due to contact with an operating fan and generator V belt or cooling fan, keep your hands and clothing away from the fan and generator V belt and cooling fans when working in the engine compartment with the engine running.
 - Do not substitute plain water for engine coolant.
 - Before adding coolant, turn the A/C switch off.
- a. Remove the reserve tank cap.
 - b. Remove the radiator drain cock and remove the O-ring from the radiator drain cock.
 - c. Inject the specified concentration of coolant through the radiator side drain cock until the radiator is full.

Specified Capacity: 14.7 liters (15.5 US qts, 12.9 Imp. qts)

- d. Squeeze the No. 1 radiator hose and No. 2 radiator hose several times by hand, and then check the level of the engine coolant.
 - i. If the engine coolant level is low, add engine coolant.
- e. Install a **NEW** O-ring to the radiator drain cock and install the radiator drain cock.
- f. Install the reserve tank cap.

Torque: 2.0 N·m {20 kgf·cm, 18 in·lbf}

NOTE: Keep the O-ring and O-ring fitting surface free of foreign matter.



DO NOT START ENGINE UNTIL AFTER INTERCOOLER COOLANT IS ADDED IN STEP 76.

- g. Bleed air from the cooling system.
 - ii. Warm up the engine until the water inlet with thermostat sub-assembly opens. While the water inlet with thermostat sub-assembly is open, circulate the engine coolant for several minutes.

NOTE:

- Make sure that the radiator reserve tank assembly still has some engine coolant in it.
 - If the engine coolant temperature gauge indicates an excessive temperature, turn off the engine and let it cool.
 - If there is not enough engine coolant, the engine may overheat or be seriously damaged.
 - If the radiator reserve tank assembly does not have enough engine coolant, perform the following: 1) stop the engine, 2) wait until the engine coolant cools down, and 3) add engine coolant until the radiator reserve tank assembly is filled to the full line.
- iii. Maintain the engine speed at 2500 to 3000 rpm.
 - iv. Squeeze the No. 1 radiator hose and No. 2 radiator hose several times by hand to bleed air.

NOTE:

- Because the engine, radiator assembly, No. 1 radiator hose and No. 2 radiator hose are extremely hot, do not perform these procedures without wearing protective gloves.
 - Performing these procedures without wearing protective gloves could result in burns.
 - Touching rotating components such as the cooling fan could result in your hand or clothing getting caught and pulled in.
- h. Stop the engine, and wait until the engine coolant cools down.
 - i. After the engine coolant cools down, check that the coolant level is at the F line. If the coolant level is below the F line, add engine coolant to the F line.
 - j. Inspect for coolant leaks.

91. ADD INTERCOOLER COOLANT (RM100000002080D)

NOTE:

- Do not remove the reserve tank cap (for Intercooler) while the coolant (for Intercooler) is still hot. Pressurized, hot coolant and steam may be released and cause serious burns.

- k. When using the GTS:
 - v. Remove the reserve tank cap (for Intercooler).
 - vi. Add engine coolant to the intercooler reserve tank filler opening until it is filled to the F line at shown in the illustration.

Standard capacity: 3.8 liters (4.0 US qts, 3.3 Imp. qts)

NOTE: Never use water as a substitute for coolant.

- vii. While adding coolant so that the coolant level is kept near the F line in the intercooler reserve tank, activate the electric water pump assembly for approximately 1 minute and then stop pump operation for 1 minute. At that time, check that air bubbles are discharged to the intercooler reserve tank.

Powertrain > Engine > Active Test

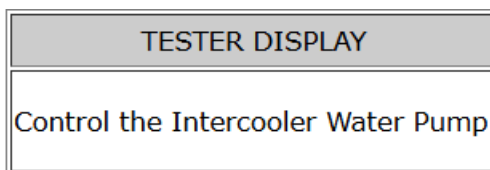

Standard: Repeat this operation approximately 3 times until the sound of the electric water pump assembly gets smaller and no more bubbles are visible from the intercooler reserve tank or the coolant level in the intercooler reserve tank stabilizes. When this condition is reached, this indicates that air is completely bled from the coolant system.

NOTE: If the intercooler reserve tank is filled excessively with coolant, coolant may spill out when the electric water pump assembly is stopped.

- viii. When air is completely bled, add coolant up to the F line in the intercooler reserve tank, and install the reserve tank cap (for Intercooler).
- ix. Install the reserve tank cap (For Intercooler)

- x. Start the engine
- xi. In order to operate the electric water pump assembly, maintain the engine speed at 2000 rpm or higher with the shift lever in N or P for 1 minute and then stop operation for 1 minute. Repeat this operation approximately 2 times until the sound of the electric water pump assembly gets smaller and no more bubbles are visible from the intercooler reserve tank or the coolant level in the intercooler reserve tank stabilizes

NOTE:

- Performing these procedures without wearing protective gloves could result in burns.
- Be careful as the radiator hoses are hot.
- Keep your hands away from the cooling fan.
- Make sure that the coolant level in the intercooler reserve tank does not drop below the L line when the engine speed is 2000 rpm or higher.
- Immediately after starting the engine, if the intercooler reserve tank runs out of coolant, perform the following: 1) stop the engine, 2) wait until the coolant has cooled down, and 3) pour in coolant until it reaches the F line.

- xii. Stop the engine and wait until the coolant cools down to ambient temperature.
- xiii. Check that the coolant level is between the F and L lines.
 1. If the coolant level is lower than the L line, pour coolant of the specified concentration into the intercooler reserve tank until it reaches the F line, and repeat the procedure from steps
 2. If the coolant level is above the F line, drain coolant so that the coolant level is between the F and L lines.
- l. Inspect for coolant (for intercooler) leaks.

92. CHECK ENGINE OIL LEVEL RM10000000200DL

- a. The oil level should be between the dipstick's low level mark and full level mark. The **NEW** engine comes prefilled with enough oil for shipping (approximately 1 quart) and if necessary, you may add oil. Warm up and stop the engine, and then wait for 5 minutes.

NOTE: Do not add engine oil to above the full level mark.

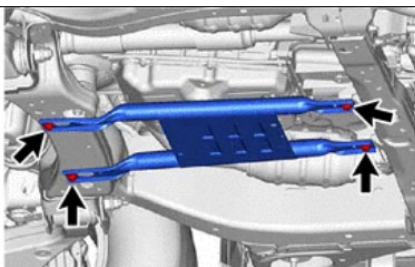

93. INSTALL OIL PAN PROTECTOR ASSEMBLY (w/ Oil Pan Protector)

Torque: 50 N·m {510 kgf·cm, 37 in·lbf}

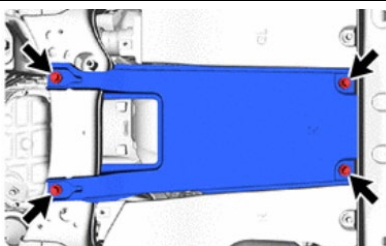

94. INSTALL FRONT TRANSMISSION UNDER COVER ASSEMBLY (w/o Oil Pan Protector)

Torque: 50 N·m {510 kgf·cm, 37 in·lbf}

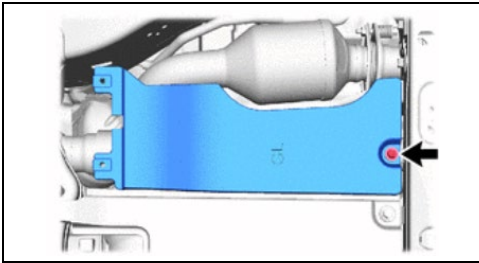

95. INSTALL FRAME UNDER COVER ASSEMBLY LH

Torque: 29 N·m {296 kgf·cm, 21 in·lbf}

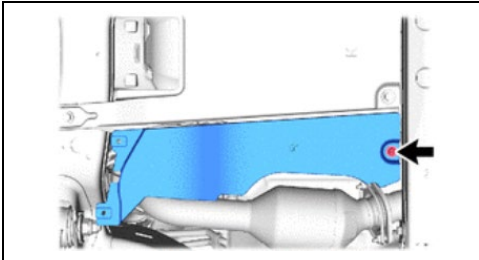

96. REMOVE FRAME UNDER COVER ASSEMBLY RH

Torque: 29 N·m {296 kgf·cm, 21 in·lbf}

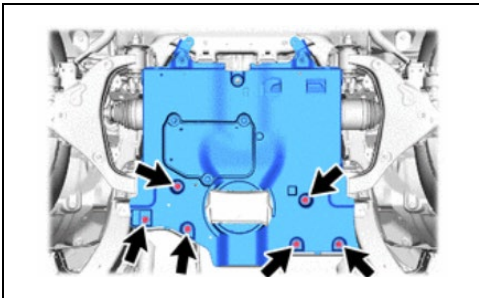

97. REMOVE NO. 2 ENGINE UNDER COVER ASSEMBLY

Torque: 29 N·m {296 kgf·cm, 21 in·lbf}

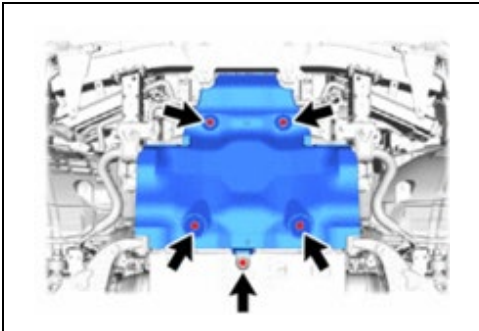

98. REMOVE NO. 1 ENGINE UNDER COVER ASSEMBLY

Torque: 29 N·m {296 kgf·cm, 21 in·lbf}



Ensure oil dip stick tube is seated correctly after installing engine. If oil dip stick tube is not completely seated, damage may occur to engine. If you have any issues, please email quality_compliance@toyota.com for further assistance.

a. Restore the vehicle to its original condition.



Ensure all ground locations are properly secured, or severe damage may occur to engine.

◀ VERIFY REPAIR QUALITY ▶

- Confirm **NEW** engine assembly is properly installed.
- Confirm cooling system is properly bled before test drive.
- Test drive vehicle to ensure engine is installed properly.
- Confirm that no new DTCs were introduced during the repair.
- Confirm the original serial number is registered in the website correctly.
- Confirm the new serial number is registered in the website correctly.
- Confirm fluids are topped off.

If you have any questions regarding this update, please contact your regional representative.

VII. CRATE USED ENGINE FOR PARTS RECOVERY

Following the [job aid](#), crate the used engine for parts return.

VIII. APPENDIX

A. CAMPAIGN DESIGNATION DECODER

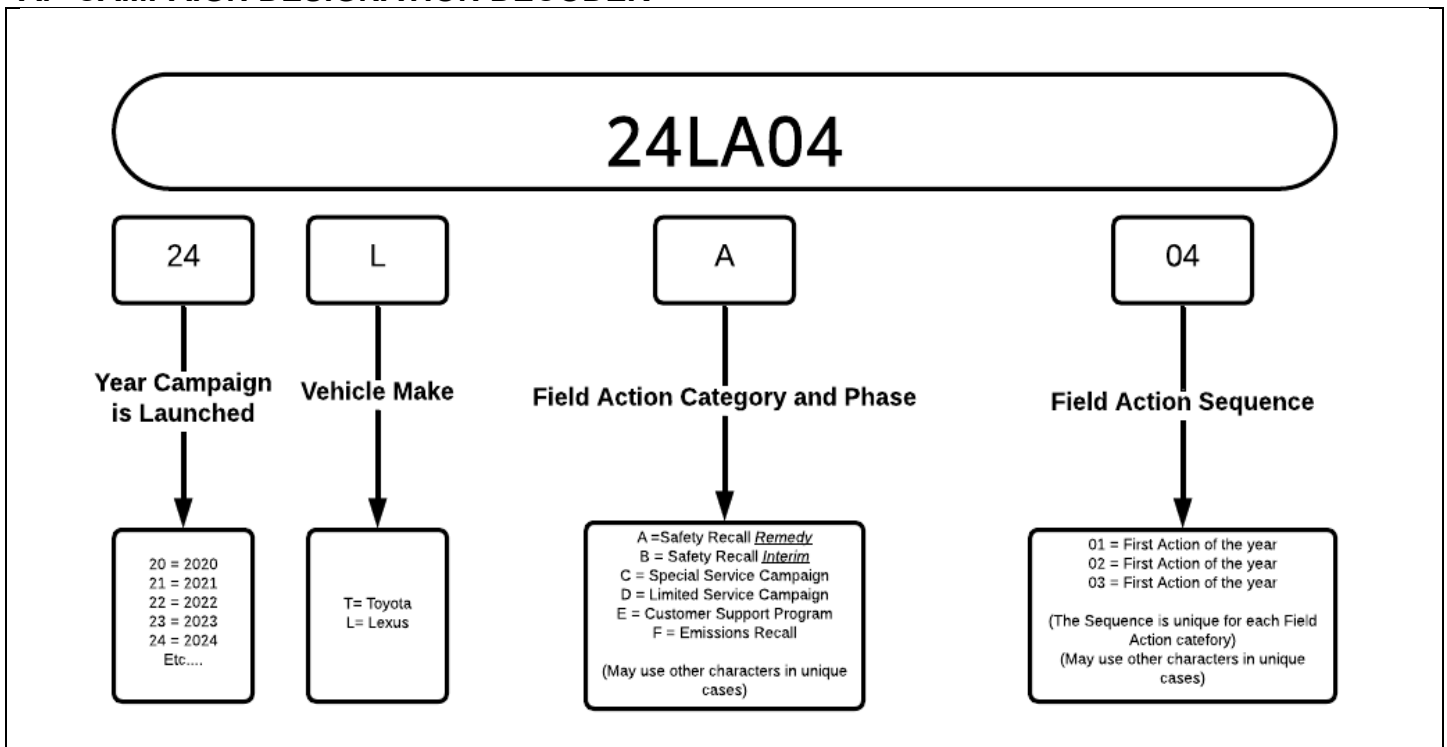

Examples:

19LA01 = Launched in 2019, Lexus, Safety Recall Remedy Phase, 1st Safety Recall Launched in 2019

20LC02 = Launched in 2020, Special Service Campaign, 2nd Special Service Campaign Launched in 2020

21LE05 = Launched in 2021, Customer Support Program, 5th Customer Support Program Launched in 2021