

TECHNICAL INSTRUCTIONS

FOR

SAFETY RECALL 24TA07

ENGINE MAY STALL DURING DRIVING

CERTAIN MODEL YEAR 2022 - 2023 Tundra

Updated

12.11.2024 – Added Bell Housing Bolt Removal and Installation Steps

12.16.2024 – Updated Parts Section to Include Engine Oil and Coolant

01.06.2025 – Updated Parts Section to Include Transmission Fluid

The repair quality of covered vehicles is extremely important to Toyota. All dealership technicians performing this recall are required to successfully complete the most current version of the E-Learning course “Safety Recall and Service Campaign Essentials”. To ensure that all vehicles have the repair performed correctly; technicians performing this repair are required to currently have completed the following courses:

- TIC201A Engine Repair
- TES001 V35A-FTS
- TER024A: 24TA07 Engine Replacement Process and Best Practices

Always check which technicians can perform the repair by logging on to <https://toyotacertification.com/certlogin.jsp>. It is the dealership’s responsibility to select technicians that have completed the above courses to perform this repair. Carefully review your resources, the technician’s skill level, and ability before assigning technicians to this repair. It is important to consider technician days off and vacation schedules to ensure there are properly trained technicians available to perform this repair at all times.

I. OPERATION FLOW CHART

The flow chart is for reference only. DO NOT use it in place of the full technical instructions. Follow ALL steps as outlined in the full technical instructions to confirm the campaign is completed correctly.

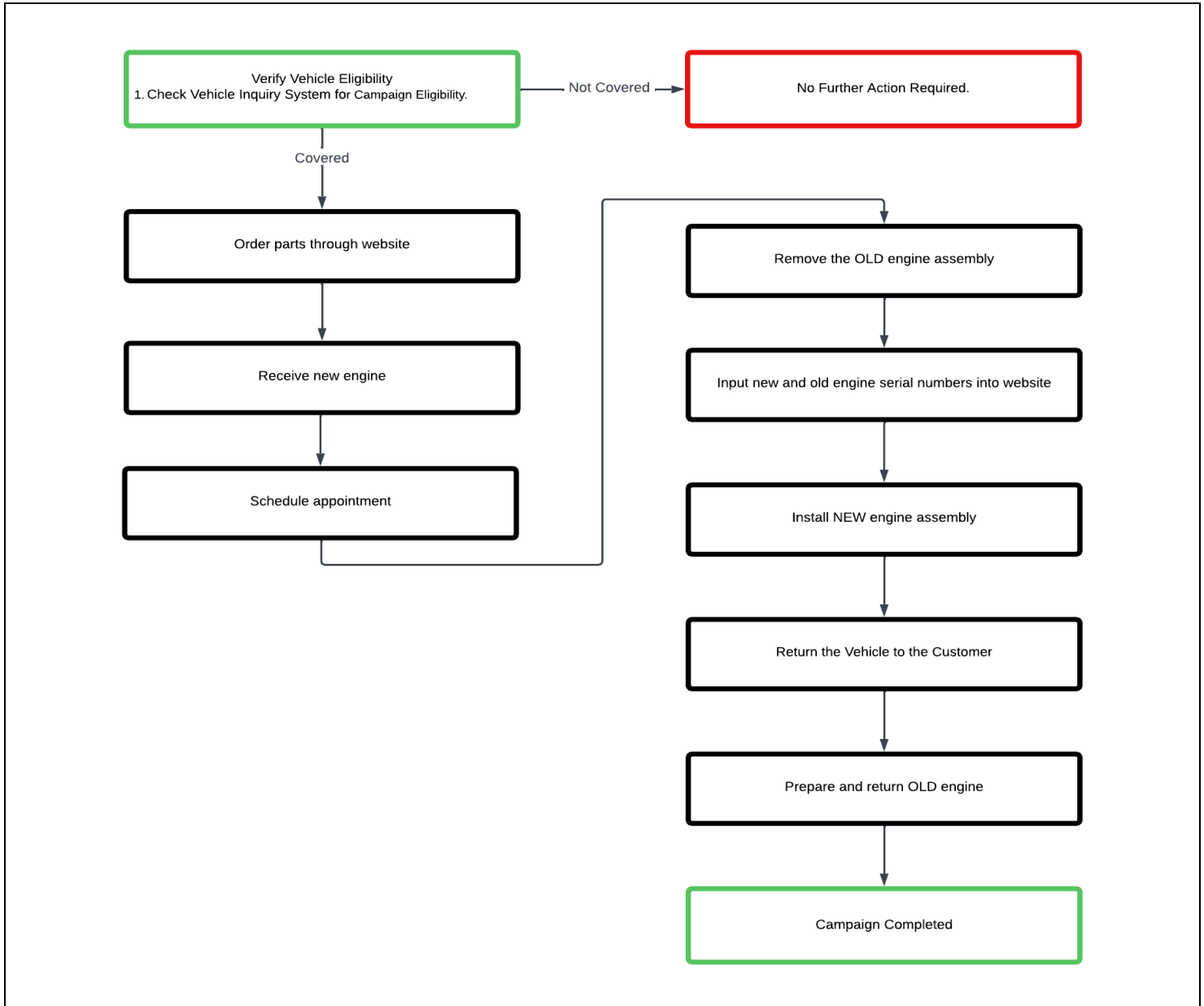

II. IDENTIFICATION OF AFFECTED VEHICLE

1. CHECK VEHICLE FOR CAMPAIGN ELIGIBILITY

- Compare the *vehicle's VIN* to the VIN listed on the Repair Order to ensure they match.
- Check the TIS Vehicle Inquiry System to confirm the VIN is involved in this Campaign, and that it has not already been completed.

NOTICE:

TMNA warranty will not reimburse dealers for repairs completed on vehicles that are not affected or were previously completed, even by another dealer.

III. PREPARATION

NOTE: All parts will be ordered via the website. All parts will arrive through standard parts network except Engine, Assy Tundra (04004-23370). Parts delivery timing for the engine assembly will differ from normal parts network lead time.

A. PARTS

Part Number	Part Description	Quantity
04004-23370	Engine, Assy Tundra (Not returnable)	1
17279-0W040	Gasket, Turbine Outlet Elbow	2
00272-SLLC2	Genuine Toyota Super Long Life Coolant	5
00289-ATFWS	World Standard Automatic Transmission Fluid (If Needed)	2
00279-0W202-01	0W20 Motor Oil - Genuine Toyota - One Quart (If needed)	1
04004-3010C	Gasket Kit (SSP Kit)*	1

* The kit above includes the following parts

Part Number	Part Description	Quantity
90069-08011	Ring, O, No.1 (For tube & accessory assy, air conditioner)	3
90069-08009	Ring, O (for suction hose)	2
90069-08007	Ring, O, No.1 (for discharge hose)	2

Part Number	Part Description	Quantity
04004-6510D	Gasket Kit (SSP Kit)*	1

* The kit above includes the following parts

Part Number	Part Description	Quantity
17451-F4010	Gasket, Exhaust pipe, No. 3	1
17451-0D140	Gasket, Exhaust pipe	2
90917-A6002	Gasket, Exhaust Pipe, Center	1
90105-A0369	Bolt, Flange	2
90177-A0021	Nut, Lock	2

Part Number	Part Description	Quantity
04004-56170	Gasket Kit (SSP Kit)*	1

* The kit above includes the following parts

Part Number	Part Description	Quantity
17452-70010	Clamp, Exhaust Pipe	2
16418-15520	Packing, Radiator Drain	1





If used engine assembly is not returned according to Toyota's instructions, the entire warranty claim amount is subject to debit. Ensure the used engine is returned following the engine return instructions.

B. TOOLS & EQUIPMENT

• GTS+	• Standard Hand Tools	• 1/2" Torque Wrench	• Pipe Insulator	• 3/8" Torque Wrench
• Bolts & nuts to secure chain on hook	• Chain (600+ lb weight rating)	• Small plastic bags	• Plywood or cardboard sheet	

Campaign SSTs: The following Campaign SSTs were shipped to your dealer prior to remedy launch of this recall and are required to be used for the remedy repair.

Image	Name	Quantity
	Norco Engine Hoist	1
 <p>Caution: The new engine is shipped with hooks that are not to be used for repair. Only use the SST service hooks pictured above when lifting the engine assemblies.</p>	Service Engine Hooks/Bolts Service Engine Hooks should be painted prior to their first use.	2 hooks 4 bolts

Part Description	Part Number
Service Engine Hook No. 1	12281-70080
Service Engine Hook No. 2	12282-70050
Service Engine Hook Bolts	90105-A0354

NOTE: Each dealer was provided one Norco High-Lift Engine Hoist at the launch of this recall. At the time of launch, this engine hoist CANNOT be ordered through the approved dealer

equipment program. If an additional engine hoist is needed, and a dealer wishes to procure one at their own expense, please ensure engine hoist height from the hook to the ground is at least 91” or hoist will not be tall enough to complete repair.

IV. BACKGROUND

There is a possibility that certain machining debris may not have been cleared from the engine when it was produced. In the involved vehicles, this can lead to potential engine knocking, engine rough running, engine no start and/or a loss of motive power. A loss of motive power while driving at higher speeds can increase the risk of a crash.

V. COMPONENTS

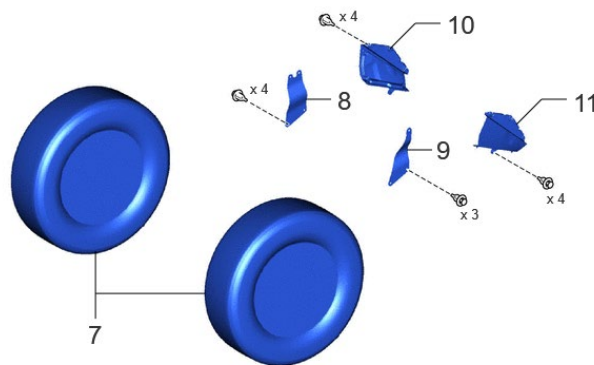

PROCEDURE		PART NAME CODE
7	FRONT WHEEL	-
8	FRONT FENDER APRON TRIM PACKING A	53782
9	FRONT FENDER APRON TRIM PACKING B	53783
10	FRONT FENDER APRON TRIM PACKING C	53784
11	FRONT FENDER APRON TRIM PACKING D	53785B

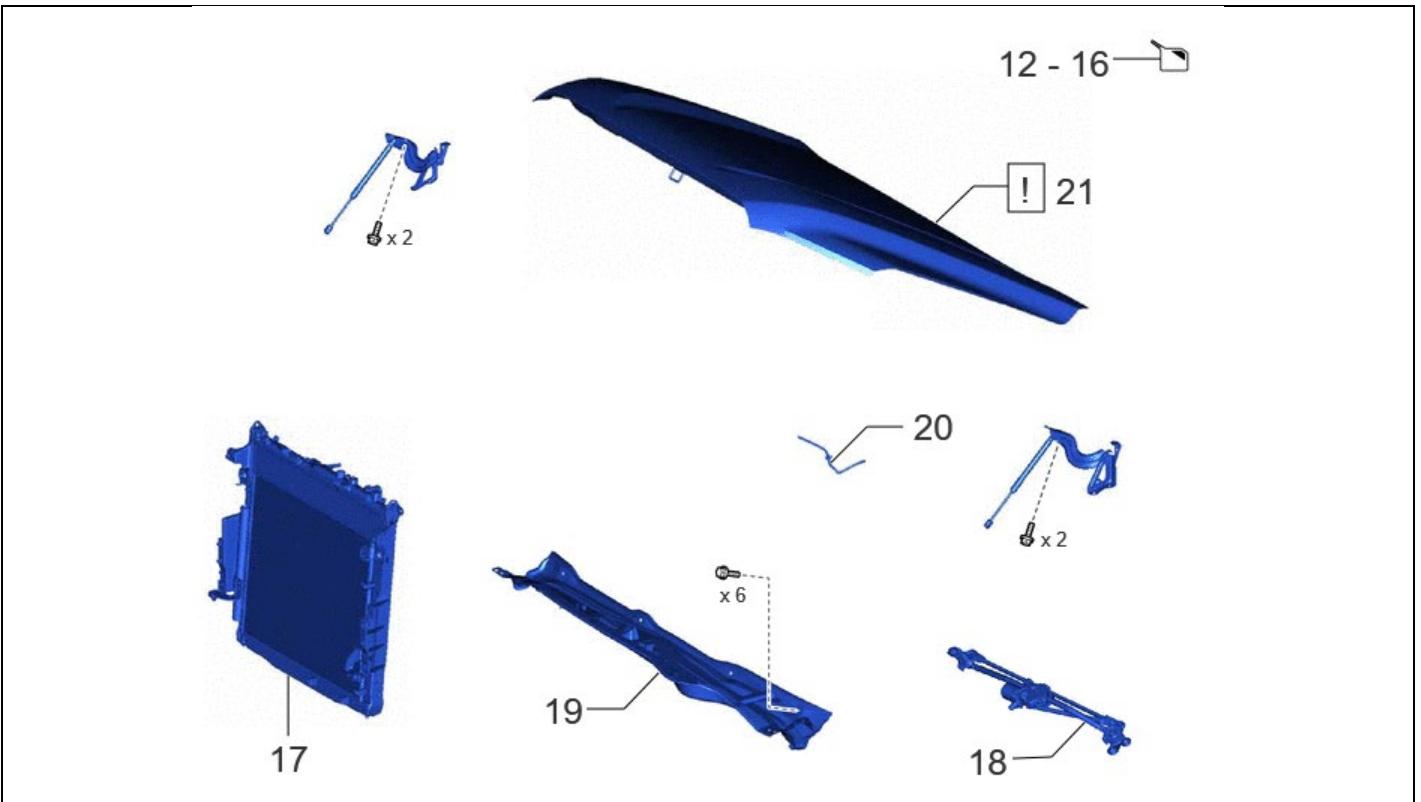

H

PROCEDURE		PART NAME CODE
12	REFRIGERANT FROM REFRIGERATION SYSTEM	-
13	DRAIN ENGINE OIL	-
14	DRAIN ENGINE COOLANT	-
15	DRAIN COOLANT (FOR INTERCOOLER)	-
18	WINDSHIELD WIPER MOTOR AND LINK	-
19	OUTER COWL TOP PANEL SUB-ASSEMBLY	55701J
20	WINDSHIELD WASHER HOSE ASSEMBLY	85376
21	HOOD SUB-ASSEMBLY	53301

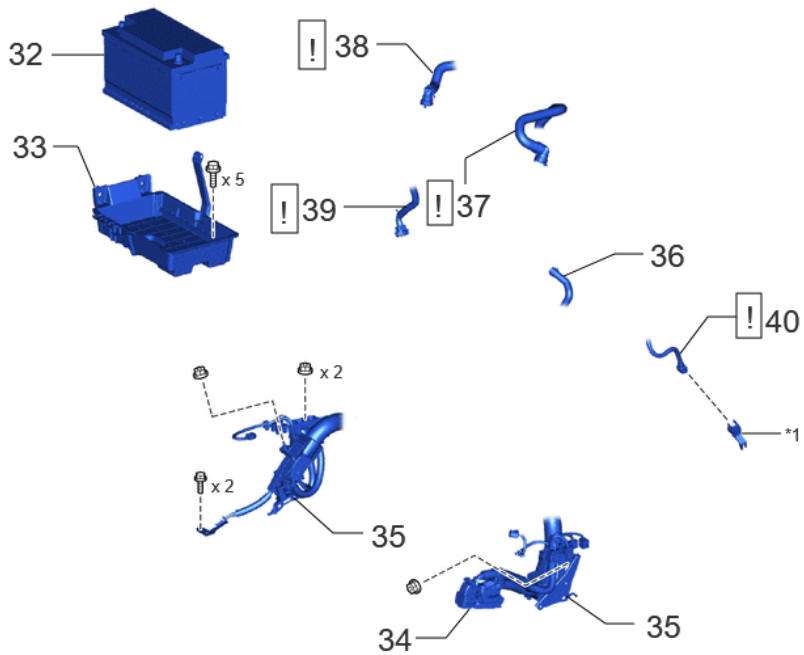

o

Procedure		Part Name Code
32	BATTERY	-
33	BATTERY CARRIER ASSEMBLY	74410
34	ECM CONNECTOR	-
35	ENGINE WIRE	82121
36	NO. 1 FUEL VAPOR FEED HOSE	23826
37	HEATER WATER HOSE L	87245L
38	OUTLET HEATER WATER HOSE B	87246B
39	NO. 1 VACUUM HOSE CONNECTOR	44777
40	FUEL TUBE SUB-ASSEMBLY	23901
*1	FUEL PIPE CLAMP	-

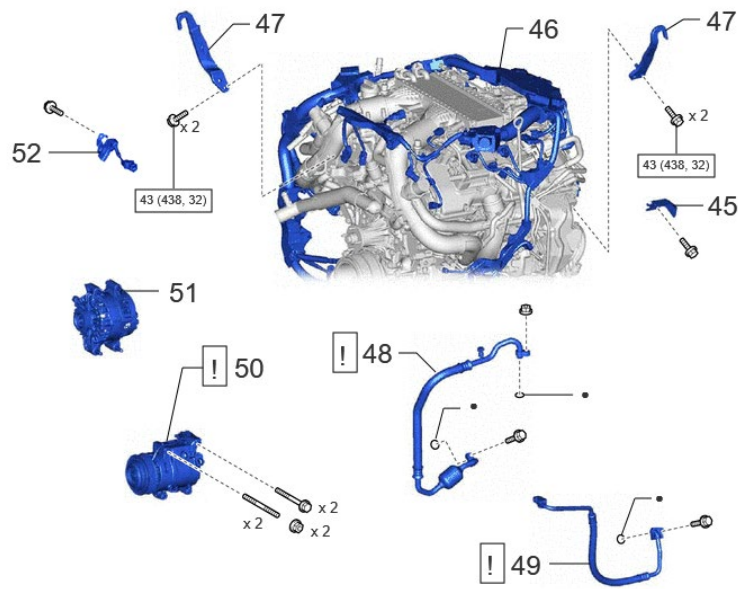

H

Procedure		Part Name Code
45	NO. 6 TURBO INSULATOR	1728C
46	ENGINE WIRE	82121
47	ENGINE HOOKS	<u>Must use service hooks!</u>
48	DISCONNECT SUCTION HOSE SUB-ASSEMBLY	88704
49	NO. 1 COOLER REFRIGERANT DISCHARGE HOSE	88711
50	COMPRESSOR ASSEMBLY WITH MAGNET CLUTCH	-
51	GENERATOR ASSEMBLY	27020
52	NO. 10 ENGINE WIRE	8212B
<input type="checkbox"/>	N*m (kgf*cm, ft.*lbf): Specified torque	<input type="checkbox"/>
		<input type="checkbox"/> Non-reusable part

59, 60 — 

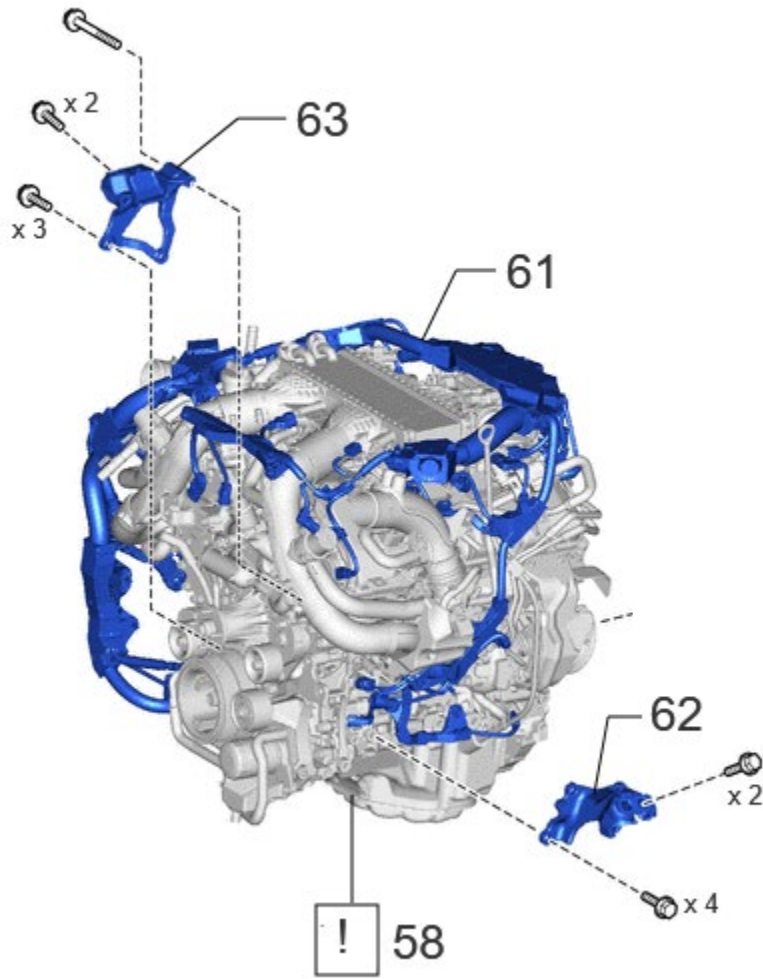

	Procedure	Part Name Code
58	ENGINE ASSEMBLY	-
60	ENGINE HANGER	-
61	ENGINE WIRE	82121
62	FRONT NO. 1 ENGINE MOUNTING BRACKET LH	12315
63	FRONT NO. 1 ENGINE MOUNTING BRACKET RH	12311

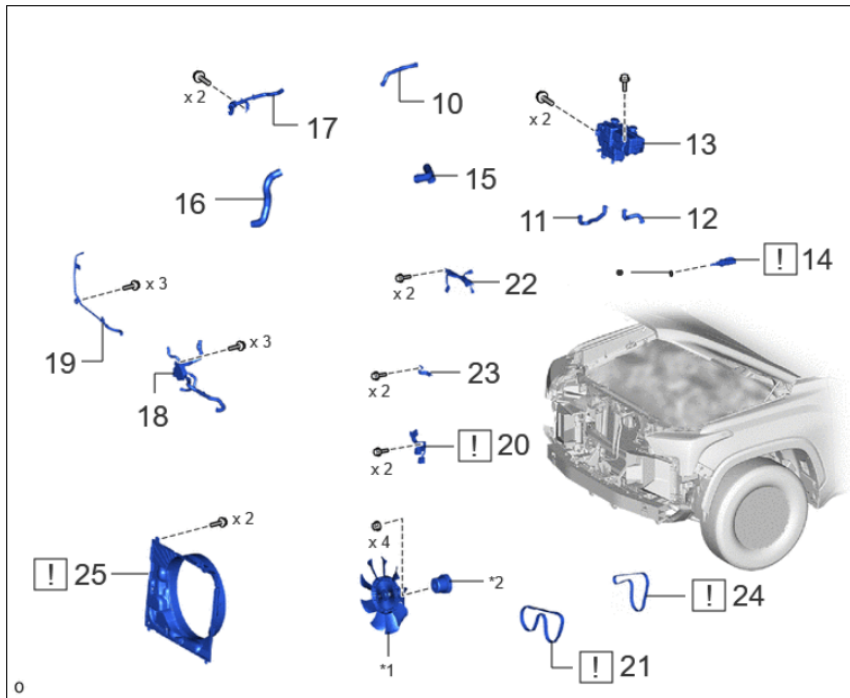

PROCEDURE		PART NAME CODE
10	WATER BY-PASS HOSE	16261
11	NO. 3 WATER BY-PASS HOSE	16267
12	NO. 2 WATER BY-PASS HOSE	16264D
13	RADIATOR RESERVE TANK ASSEMBLY	164A2
15	NO. 1 RADIATOR HOSE	16571C
16	NO. 2 RADIATOR HOSE	16572D
17	NO. 2 WATER BY-PASS PIPE	16278
18	OIL COOLER ASSEMBLY WITH OIL COOLER HOSE	-
19	OIL COOLER TUBE SUB-ASSEMBLY	-
20	COOLING FAN WIRE	16364A
21	NO. 1 V BELT (COOLER COMPRESSOR TO CRANKSHAFT PULLEY)	88310A
22	ENGINE WIRE	82121
23	NO. 1 AIR TUBE SUPPORT	17368G
24	FAN AND GENERATOR V BELT	16361A
25	FAN SHROUD	16711

*1	FLUID COUPLING ASSEMBLY WITH FAN	*2	FAN PULLEY
●	Non-reusable part	-	-

VI. REPAIR INSTRUCTIONS

1. Ensure engine is ordered using instructions in [24TA07 Dealer Letter](#).
2. Engine Crate Disassembly



Engine Crate will be reused to return the OLD engine, so DO NOT damage the crate or the plastic bag inside the crate.

Using a Torx T25 bit/socket, remove all screws with arrows pointing to them to disassemble crate. To disassemble the crate, you will not need to remove any nails.

Please see below for example of arrows pointed to T25 screws that will need to be removed.



3. Engine Assembly 04004-23370 Overview

While the **NEW** engine assembly contains most components such as intercooler, turbos, and fuel system, some components will need to be transferred from the existing engine to the replacement engine such as:

- Starter
- Engine Wire Harness
- Alternator
- A/C Compressor
- Drive belt tensioner
- Drive belts

See pictures below for reference of engine assembly.



4. Confirm correct engine hooks/bolts are being used to lift engine.

NOTE: Spray paint service engine hooks (thicker base) a color that is easily visible such as yellow, orange, red, white, etc., before using.

SST Service Hooks



Part Number of SST

- No.1 Service Engine Hook = 12281-70080
- No.2 Service Engine Hook = 12282-70050
- Service Hook Bolts = 90105 - A0354

SST service hooks have a thicker base to support the side load placed on the hooks when lifting with chain.

Do Not Use – Hooks used to ship engine in crate (see warning label on hooks)

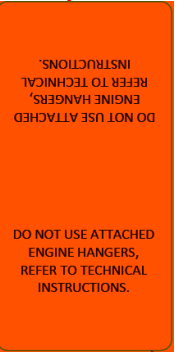

The hooks used for shipping have a base that is too thin for lifting with chain and hoist.

VII. REPAIR INSTRUCTIONS



Only complete the following repair procedure after completing steps above.

1. REMOVE THE ENGINE ASSEMBLY

NOTICE:

Carefully read the cautions written in the repair manual and perform the written instructions correctly.



IF ENGINE IS SEIZED (CANNOT BE TURNED OVER BY HAND) SEE STEP 74 OF THIS SECTION.



1. CHECK FOR DTCS

- Using a Techstream/GTS+, check for Diagnostic Trouble Codes.

NOTICE:

This Safety Recall only covers the engine replacement. It does not cover the diagnosis or replacement of any other systems on the vehicle.

2. DISABLE PARKING BRAKE and DISCHARGE FUEL PRESSURE

- Turn the ignition ON (key on, engine off).
- Depress brake pedal
- Press the electric parking brake switch on the center console to release the brake
- Check that the parking brake indicator light on the combination meter turns off
- Remove the EFI-MAIN No. 2 relay.
- Loosen or remove the fuel tank cap assembly.
- Start the engine and slightly depress the accelerator pedal (50% or more).
- Keep accelerator applied until engine stops running
- Turn the ignition switch OFF
- Install fuel cap
- Install EFI-MAIN No.2 Relay.

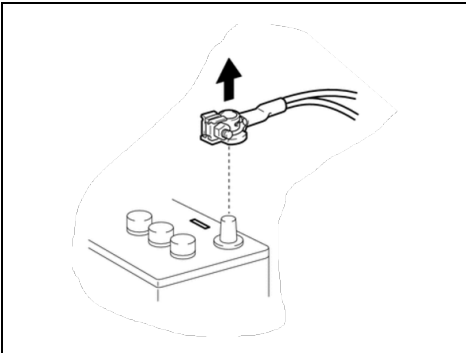

3. DISCONNECT CABLE FROM NEGATIVE BATTERY TERMINAL

4. REMOVE NO. 1 ENGINE UNDER COVER ASSEMBLY

- a. w/ Front Active Spoiler System:
Set the front active spoiler to the service deploy position.

CAUTION: Make sure that your hands, etc. do not get caught while the front active spoiler is operating.

1. Turn the ignition switch off.

2. Set the windshield wiper switch assembly to "mist" and hold it for 2 seconds.

NOTICE: Operate within 45 seconds after turning the ignition switch to off

3. Make sure that the spoiler is forcibly deployed.

HINT: It will retract with the ignition switch ON and the shift lever in D or R

(2) Remove the 4 bolts and No. 1 engine under cover Assembly.

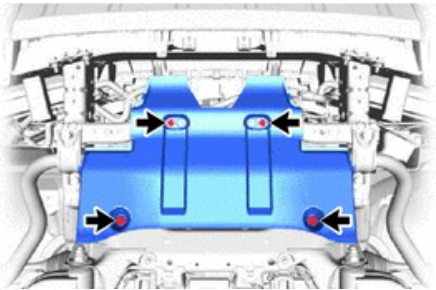

5. REMOVE FRONT WHEEL

- a. Remove the 6 lug nuts and remove front wheel
b. Repeat on other side

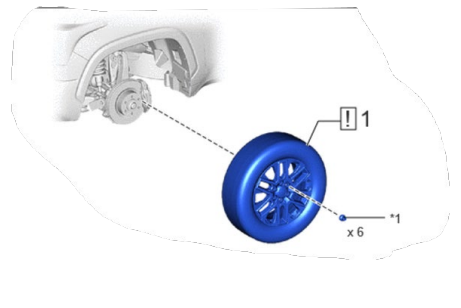

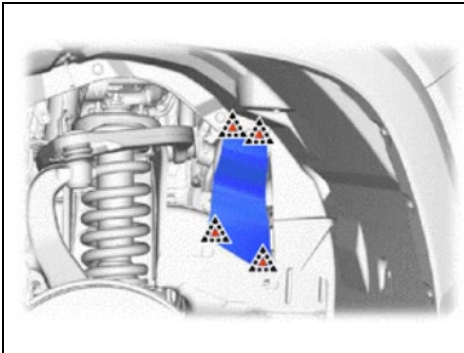

6. REMOVE FRONT FENDER APRON TRIM PACKING A

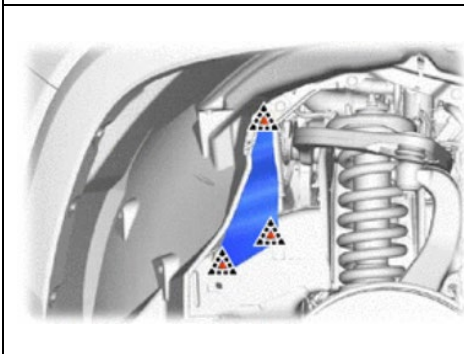

7. REMOVE FRONT FENDER APRON TRIM PACKING B

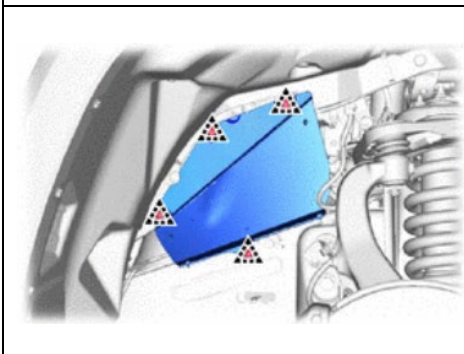

8. REMOVE FRONT FENDER APRON TRIM PACKING C

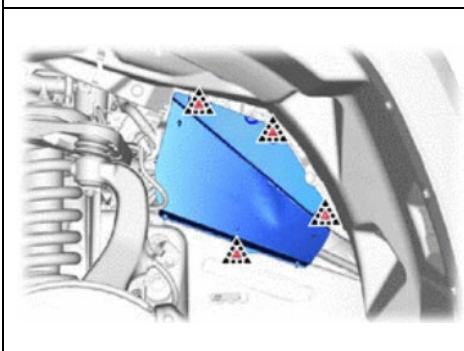

9. REMOVE FRONT FENDER APRON TRIM PACKING D

10. RECOVER REFRIGERANT FROM REFRIGERATION SYSTEM

- a. Recover the refrigerant from the A/C system using a refrigerant recovery unit.

11. DRAIN ENGINE OIL

- a. Remove drain plug and drain engine oil.
- b. Reinstall drain plug after empty.

12. DRAIN ENGINE COOLANT

- a. Connect a hose with an inside diameter of 9 mm (0.354 in.) to the radiator drain cock as shown in the illustration.
- b. Connect a hose with an inside diameter of 8 mm (0.315 in.) to the cylinder block water drain cock plug as shown in the illustration.
- c. Loosen the radiator drain cock plug
- d. Remove the reserve tank cap. Then drain the engine coolant
- e. Loosen the cylinder block water drain cock plug
- f. Tighten the cylinder block water drain cock plug.
Torque:

12.7 N·m {130 kgf·cm, 9 ft·lbf}

- g. Tighten the radiator drain cock plug by hand
- h. Disconnect the hose from the cylinder block water drain cock plug
- i. Disconnect the hose from the radiator drain cock

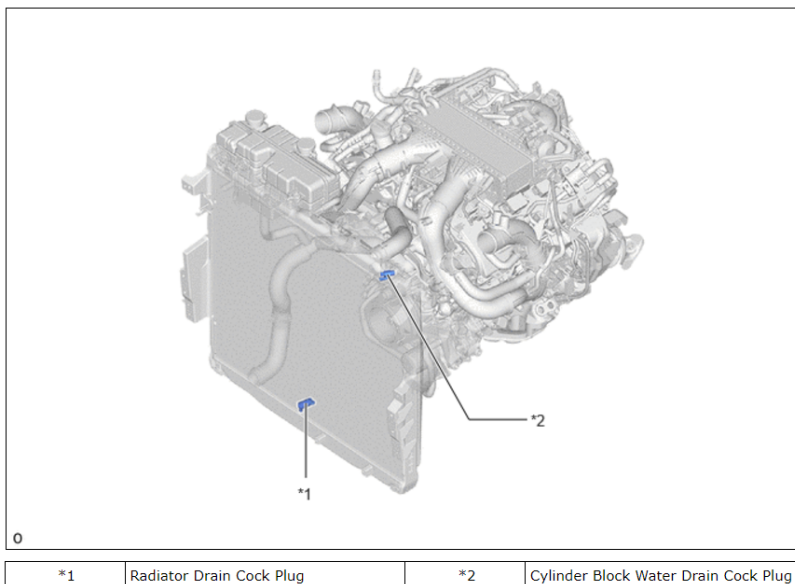

13. DRAIN ENGINE COOLANT (FOR INTERCOOLER)

- a. Connect a hose with an inside diameter of 8 mm (0.315 in.) to the radiator drain cock sub-assembly
- b. Loosen the radiator drain cock sub-assembly (for Intercooler) and drain the coolant
- c. Tighten the radiator drain cock sub-assembly (for Intercooler) by hand after empty

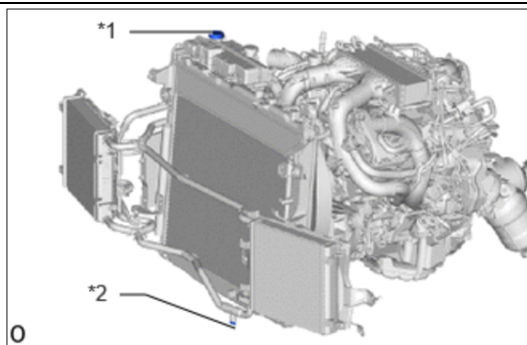

*1	Reserve Tank Cap (for Intercooler)
*2	Radiator Drain Cock Sub-assembly (for Intercooler)

14. REMOVE NO. 2 RADIATOR AIR GUIDE

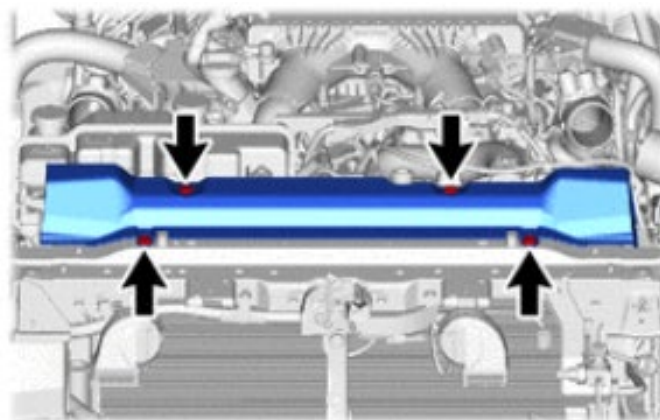

15. REMOVE V-BANK COVER SUB-ASSEMBLY

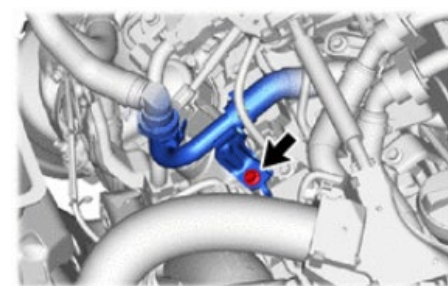
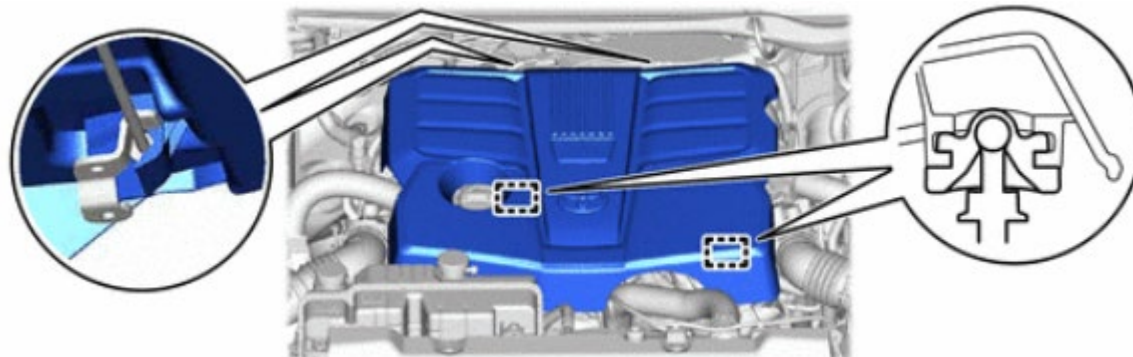

16. DISCONNECT NO. 4 WATER BY-PASS PIPE

17. REMOVE AIR CLEANER ASSEMBLY RH WITH AIR CLEANER HOSE ASSEMBLY RH

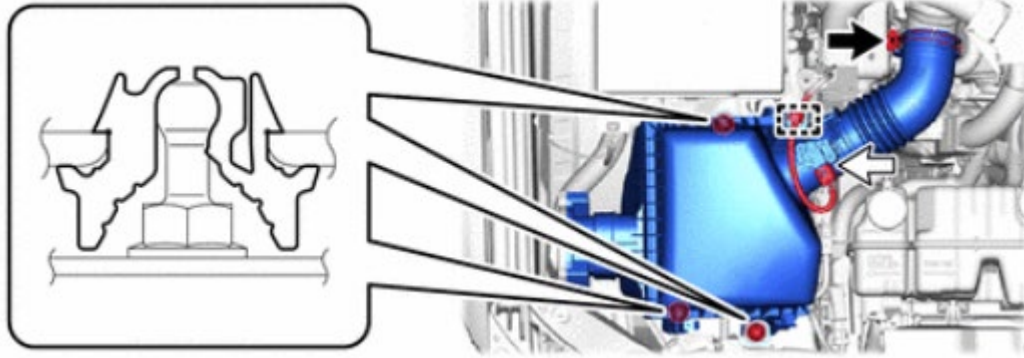

18. REMOVE AIR CLEANER ASSEMBLY LH WITH AIR CLEANER HOSE ASSEMBLY LH

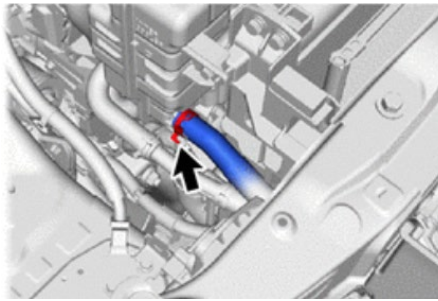
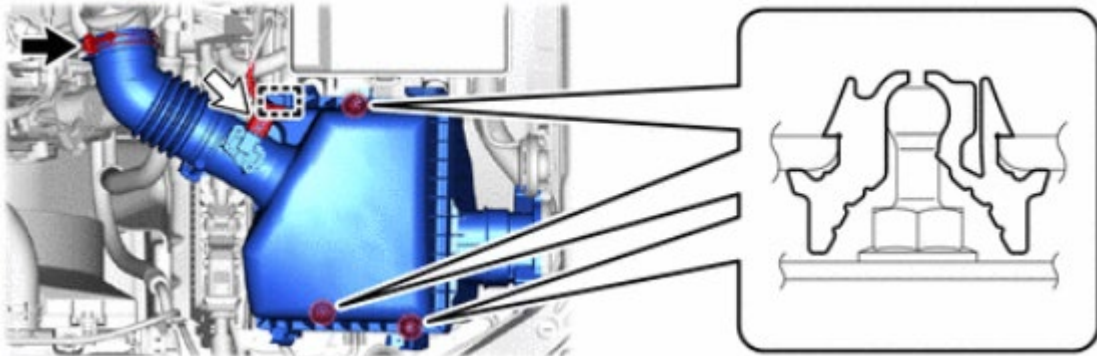

19. DISCONNECT WATER BY-PASS HOSE



20. DISCONNECT NO. 3 WATER BY-PASS HOSE

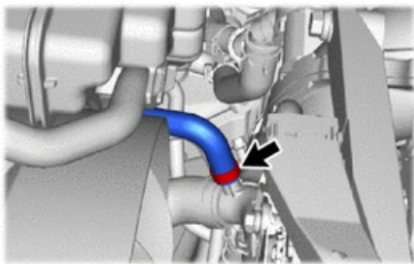

21. DISCONNECT NO. 2 WATER BY-PASS HOSE

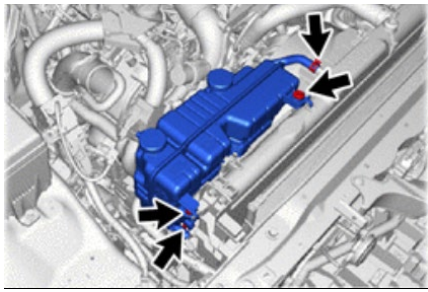

22. REMOVE RADIATOR RESERVE TANK ASSEMBLY

23. DISCONNECT ENGINE COOLANT TEMPERATURE SENSOR

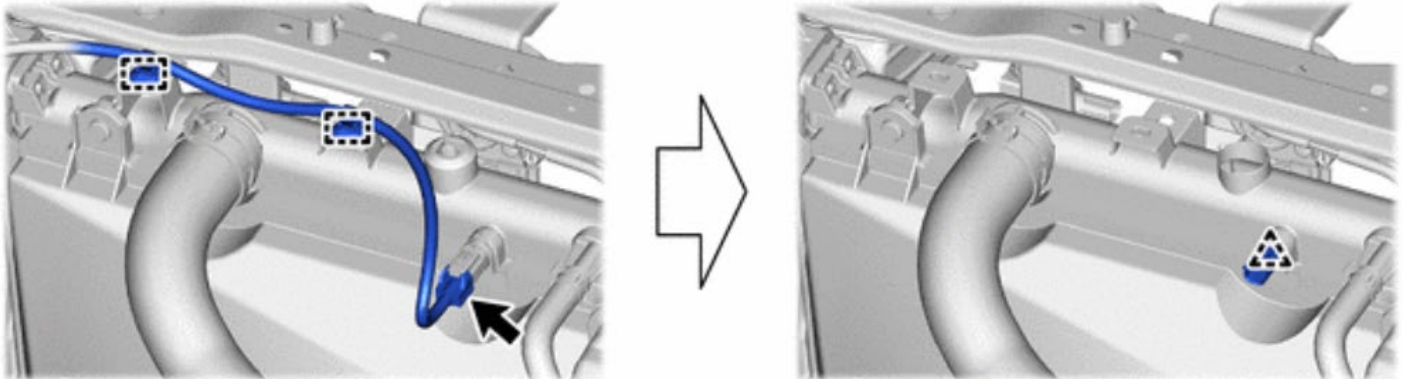

NOTE: If the engine coolant temperature sensor has been struck or dropped, replace it.

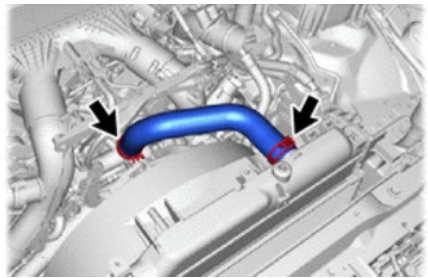

24. REMOVE NO. 1 RADIATOR HOSE

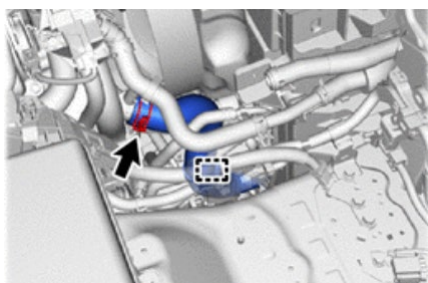

25. DISCONNECT NO. 2 RADIATOR HOSE

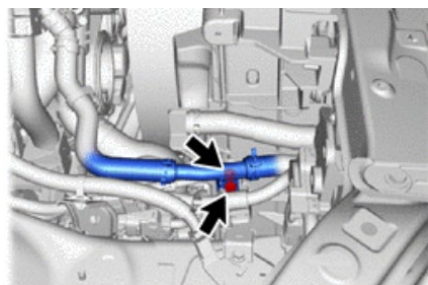

26. DISCONNECT NO. 2 WATER BY-PASS PIPE

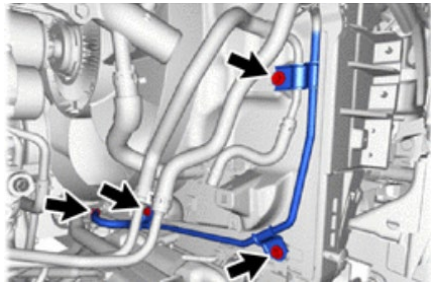

27. DISCONNECT OIL COOLER TUBE SUB-ASSEMBLY

28. REMOVE COOLING FAN WIRE

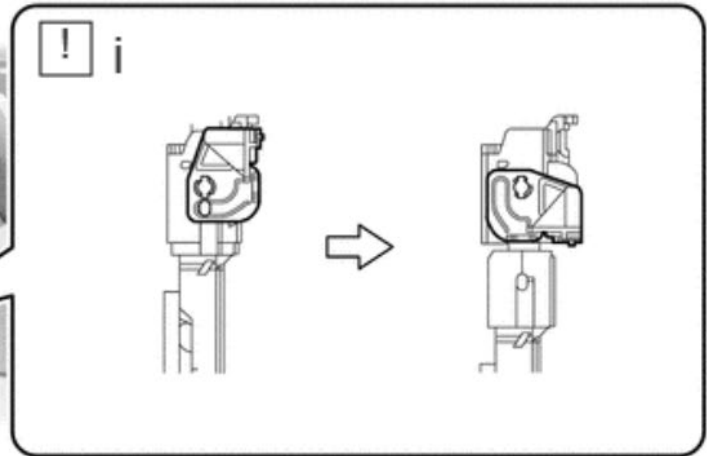
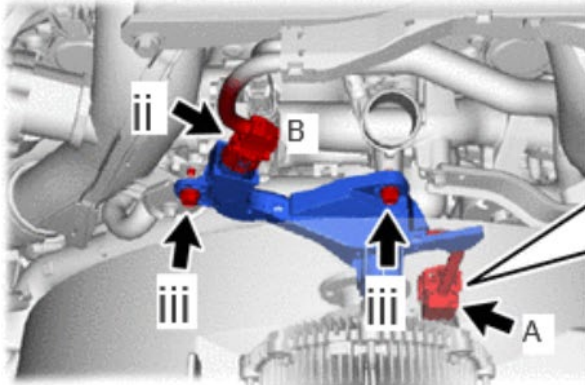

1. Push the lever down to release the lock and disconnect connector A.
2. Disconnect the connector B.
3. Remove the 2 bolts and cooling fan wire.

29. REMOVE NO. 1 V BELT (COOLER COMPRESSOR TO CRANKSHAFT PULLEY)

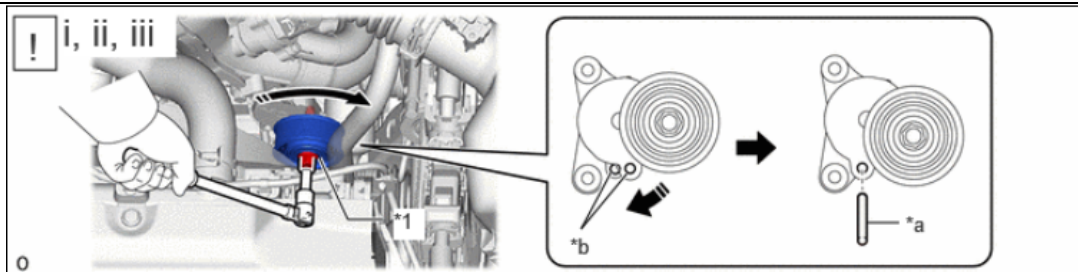

*1	V-ribbed Belt Tensioner Assembly	-	-
*a	5 mm Hexagon Wrench	*b	Hole
	Turn in this Direction	-	-

1. Release the No. 1 V belt (cooler compressor to crankshaft pulley) tension by turning the V-ribbed belt tensioner assembly clockwise and remove the No. 1 V belt (cooler compressor to crankshaft pulley) from the V-ribbed belt tensioner assembly.
2. Rotate the V-ribbed belt tensioner assembly clockwise to align the holes and then insert a 5 mm hexagon wrench to secure the V-ribbed belt tensioner assembly in place.
3. Remove the No. 1 V belt (cooler compressor to crankshaft pulley).

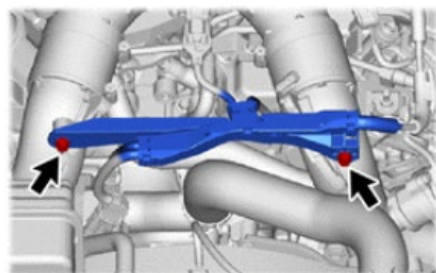

30. DISCONNECT ENGINE WIRE

31. REMOVE FAN AND GENERATOR V BELT

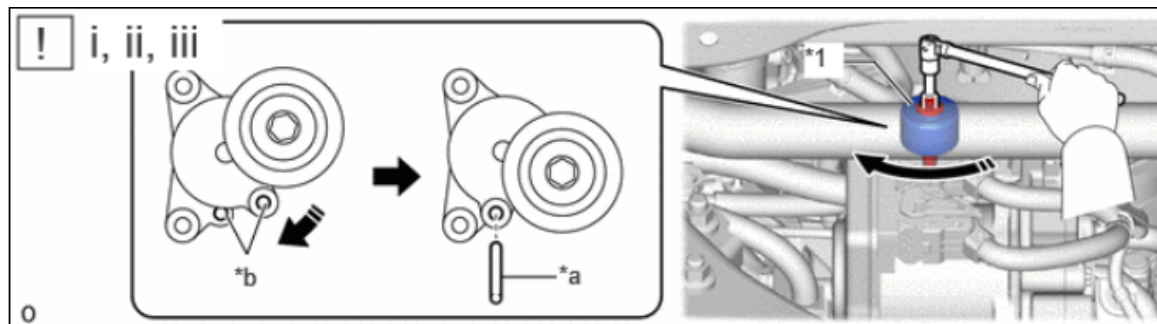

*1	V-ribbed Belt Tensioner Assembly	-	-
*a	5 mm Hexagon Wrench	*b	Hole
	Turn in this Direction	-	-

1. Release the fan and generator V belt tension by turning the V-ribbed belt tensioner assembly clockwise and remove the fan and generator V belt from the V-ribbed belt tensioner assembly.
2. Rotate the V-ribbed belt tensioner assembly clockwise to align the holes and then insert a 5 mm hexagon wrench to secure the V-ribbed belt tensioner assembly in place.
3. Remove the fan and generator V belt.

32. REMOVE FAN SHROUD

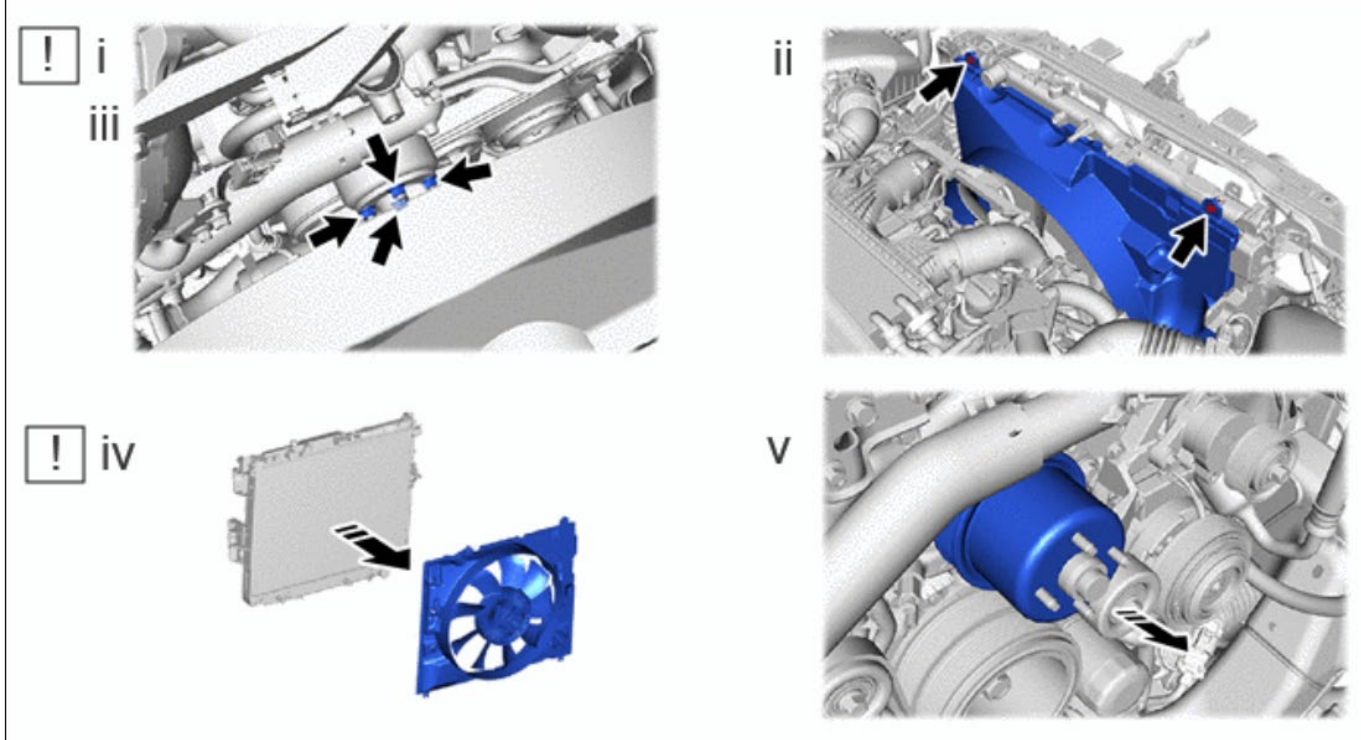

	Remove in this Direction	-	-
--	--------------------------	---	---

1. Loosen the 4 nuts holding the fluid coupling assembly with fan.
2. Remove the 2 bolts holding the fan shroud.
3. Remove the 4 nuts.
4. Remove the fan shroud together with the fluid coupling assembly with fan.

NOTE: Be careful not to damage the radiator core.

5. Remove the fan pulley from the engine water pump assembly.

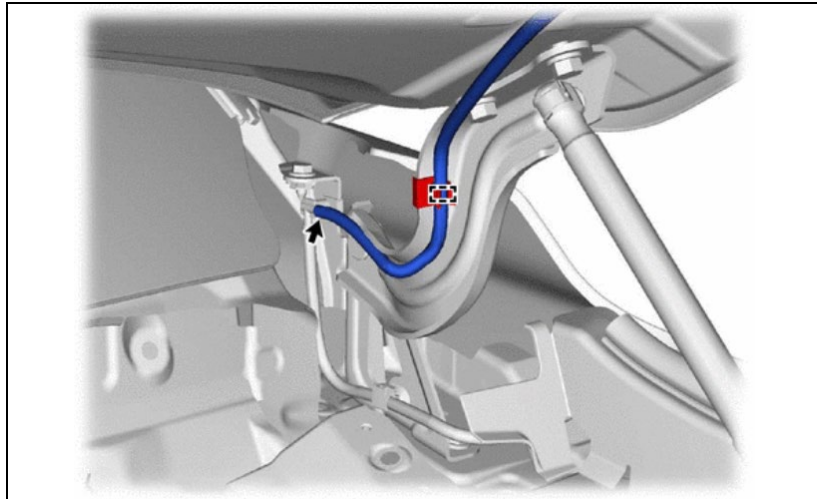

33. DISCONNECT WINDSHIELD WASHER HOSE ASSEMBLY

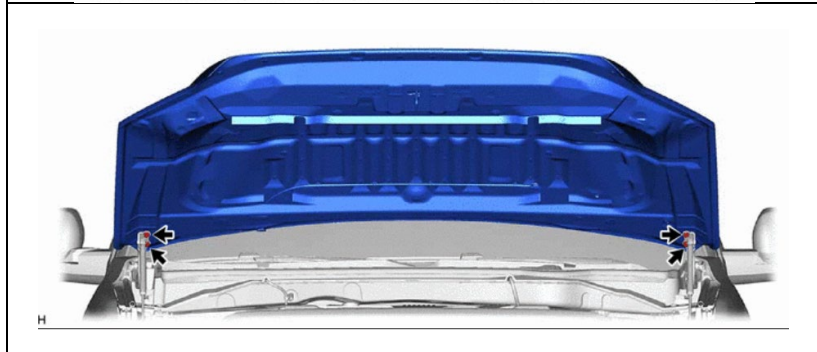

34. REMOVE HOOD SUB-ASSEMBLY

NOTE: Be sure to perform this procedure with several people as the hood sub-assembly is very heavy.

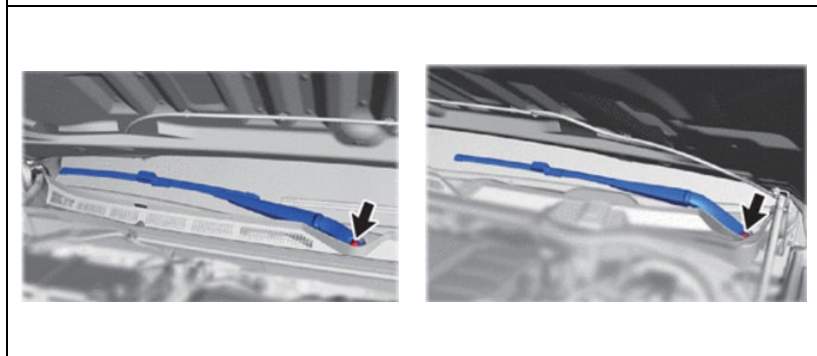

35. REMOVE WIPER ARM ASSEMBLIES RH & LH

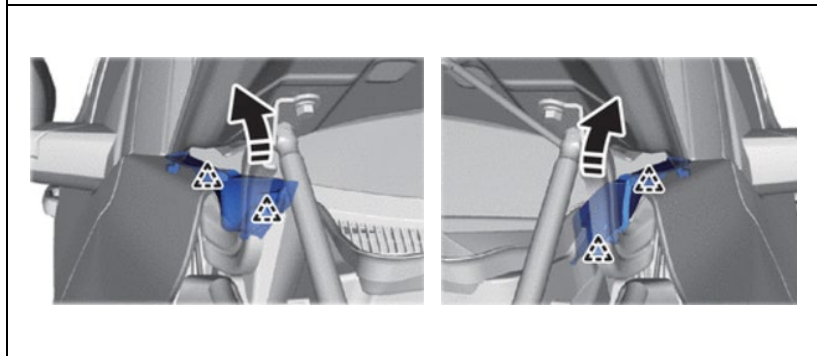

36. REMOVE FRONT FENDER TO COWL SIDE SEAL RH & LH

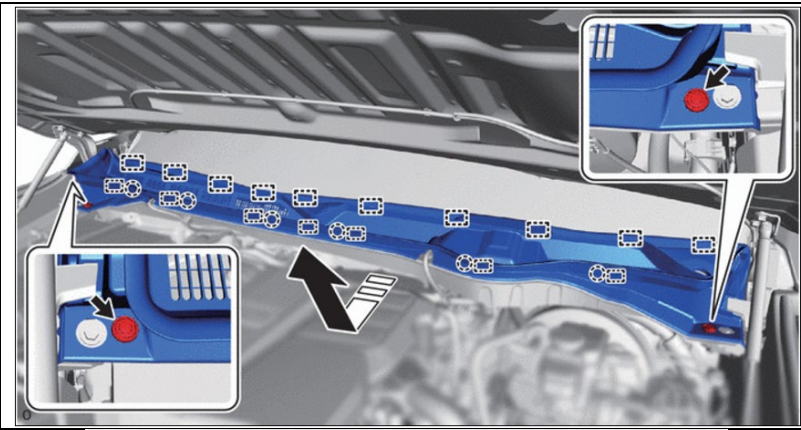

37. REMOVE COWL TOP VENTILATOR LOUVER SUB-ASSEMBLY

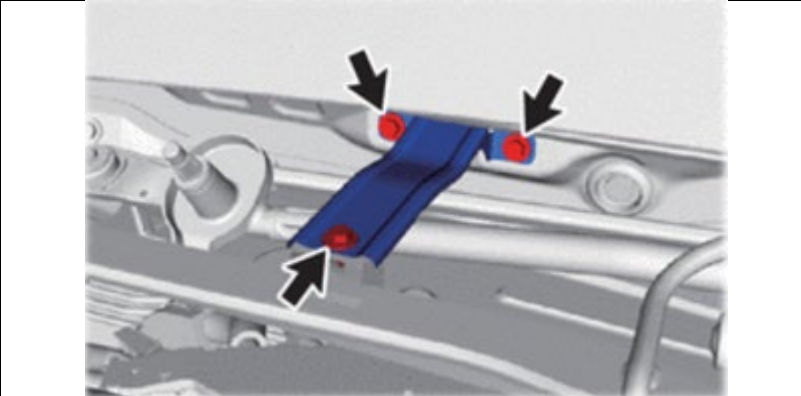

38. REMOVE INNER NO. 2 COWL TOP REINFORCEMENT

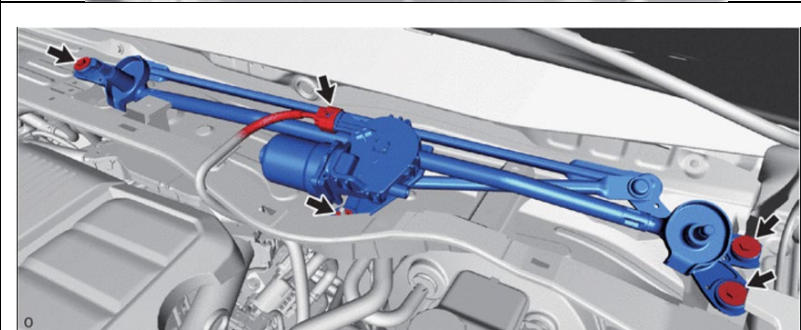

39. REMOVE WINDSHIELD WIPER MOTOR AND LINK ASSEMBLY

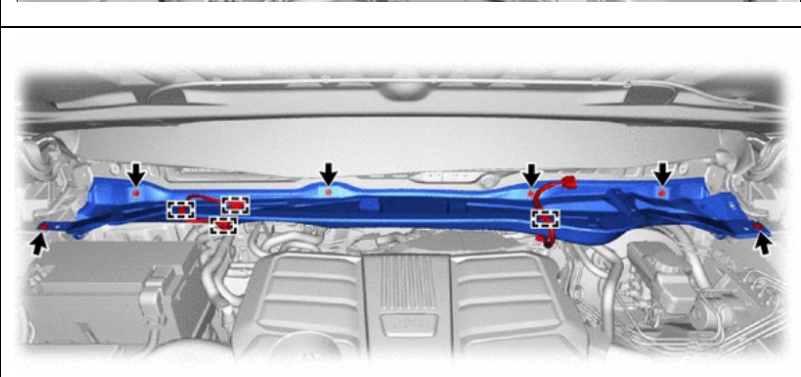

40. REMOVE OUTER COWL TOP PANEL SUB-ASSEMBLY

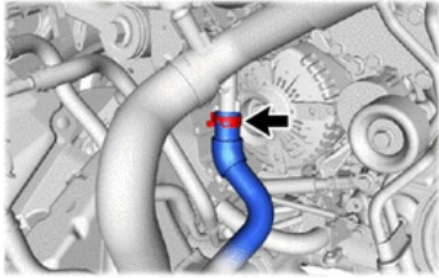

41. DISCONNECT NO. 3 WATER BY-PASS HOSE

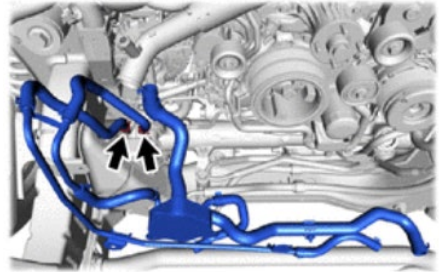

42. REMOVE OIL COOLER TUBE AND OIL COOLER HOSE WITH OIL COOLER ASSEMBLY

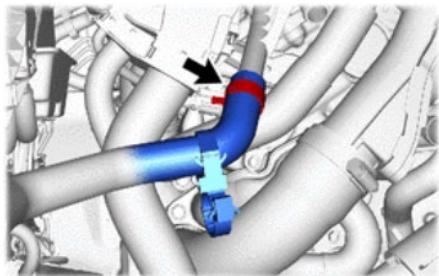

43. DISCONNECT NO. 4 WATER BY-PASS HOSE

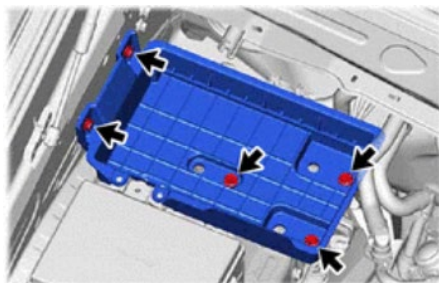

44. REMOVE BATTERY AND BATTERY CARRIER ASSEMBLY

45. DISCONNECT ECM CONNECTOR

- a. Detach the 2 wire connector clamps.
- b. Push in the locks on the 3 levers, raise the 3 levers, and disconnect the 3 ECM connectors.

! ii

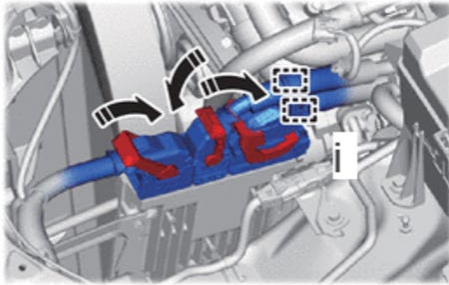

! iv

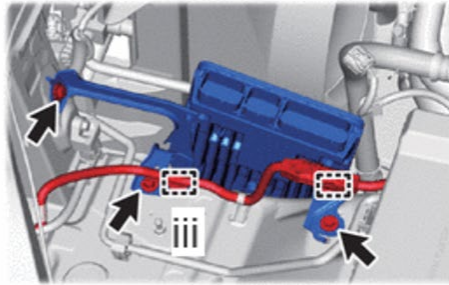

o
c.

46. DISCONNECT ENGINE WIRE

NOTE: After disconnecting the wire harness, secure it with tape or equivalent to keep it out of the way.

*A

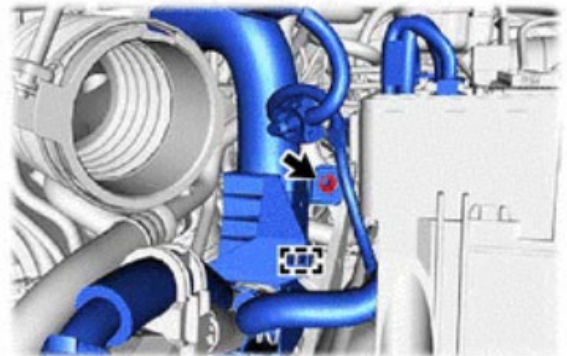
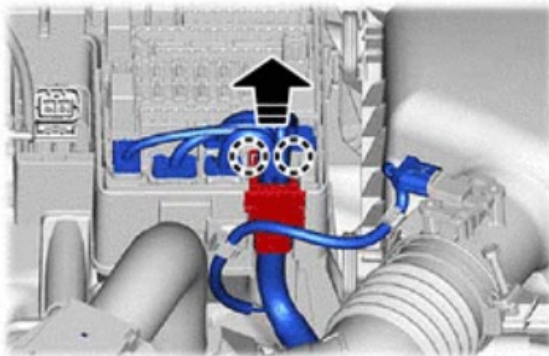
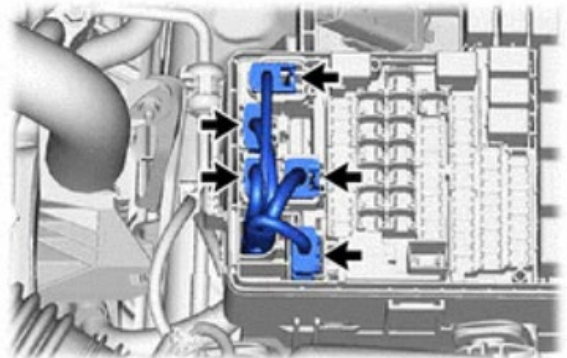

*A	for LH side	-	-
	Remove in this Direction	-	-

*A

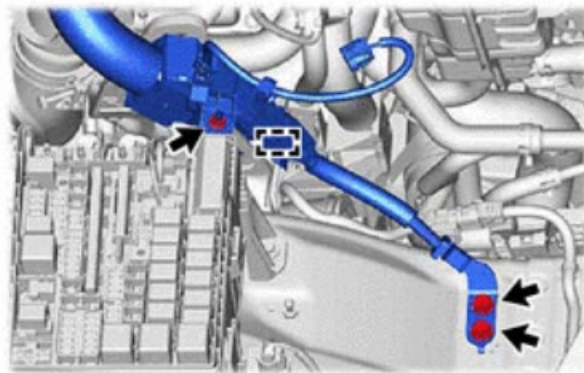
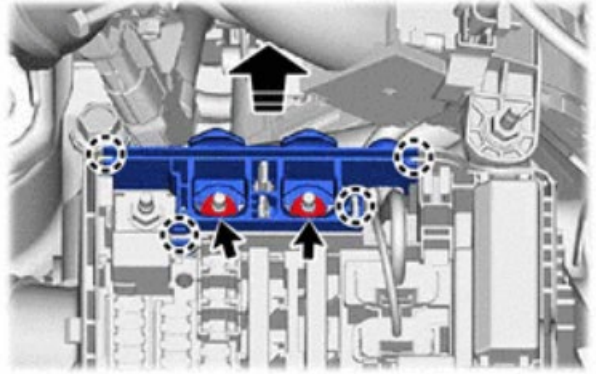

*A	for RH side	-	-
	Remove in this Direction	-	-

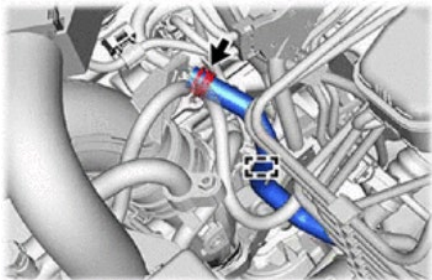

47. DISCONNECT NO. 1 FUEL VAPOR FEED HOSE

48. DISCONNECT HEATER WATER HOSE L

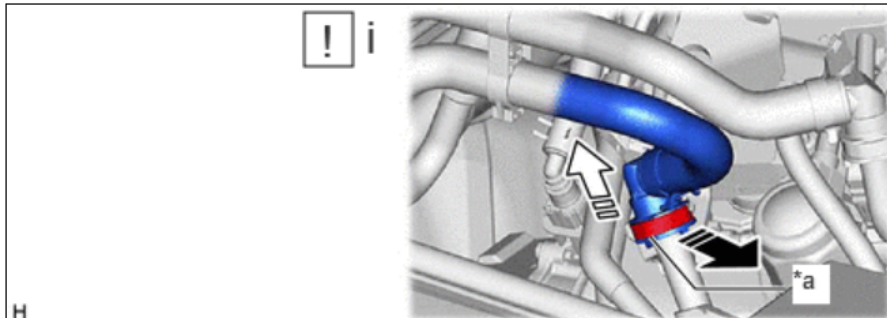

*a	Retainer	-	-
	Pull out		Pull off

a. Disconnect the heater water hose L connector from the water by-pass hose assembly.

NOTE: Remove any foreign matter on the water by-pass hose assembly and heater water hose L connector before performing this work.

1. Pull out the retainer to disengage the lock claws and pull off the heater water hose L connector.
2. Check that there is no foreign matter on the sealing surfaces of the disconnected water lines. Clean them if necessary.
3. Cover the disconnected heater water hose L connector with a plastic bag to prevent damage and contamination.

49. DISCONNECT OUTLET HEATER WATER HOSE B

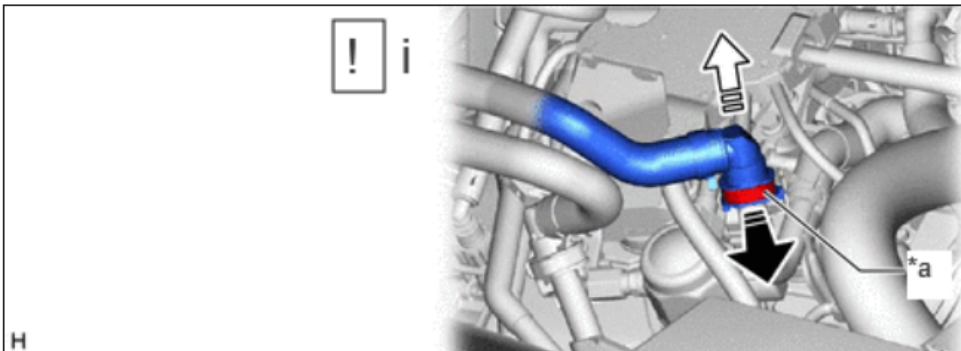

*a	Retainer	-	-
	Pull out		Pull off

a. Disconnect the outlet heater water hose B connector from the No. 4 water by-pass pipe.

NOTE: Remove any foreign matter on the No. 4 water by-pass pipe and outlet heater water hose B connector before performing this work.

1. Pull out the retainer to disengage the lock claws and pull off the outlet heater water hose B connector.
2. Check that there is no foreign matter on the sealing surfaces of the disconnected water lines. Clean them if necessary.
3. Cover the disconnected outlet heater water hose B connector with a plastic bag to prevent damage and contamination.

50. DISCONNECT NO. 1 VACUUM HOSE CONNECTOR

NOTE: Be sure to disconnect the No. 1 vacuum hose connector by hand.

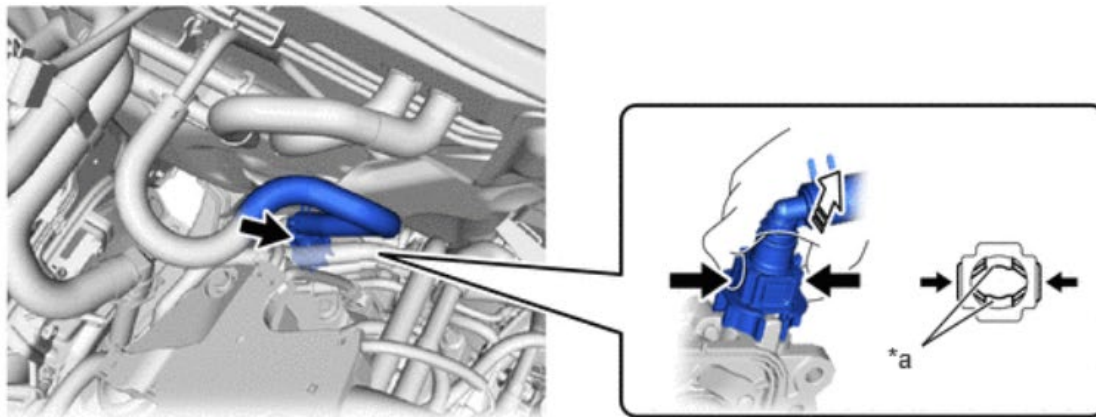

*a	Retainer	-	-
	Pinch		Pull off

- a. Pinch the retainer of the No. 1 vacuum hose connector, and then pull the No. 1 vacuum hose connector off of the vacuum pump assembly.

51. DISCONNECT FUEL TUBE SUB-ASSEMBLY

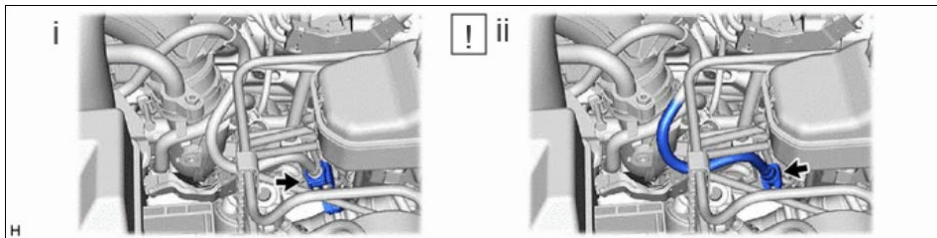

1. Remove the fuel pipe clamp from the fuel tube connector.
2. Disconnect the fuel tube sub-assembly.

52. REMOVE NO. 2 PCV HOSE (NO. 2 VENTILATION HOSE)

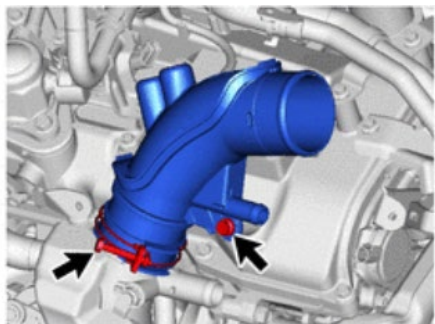
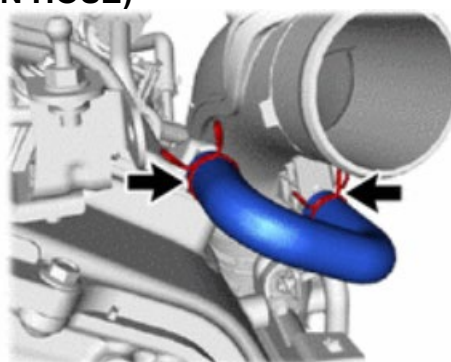
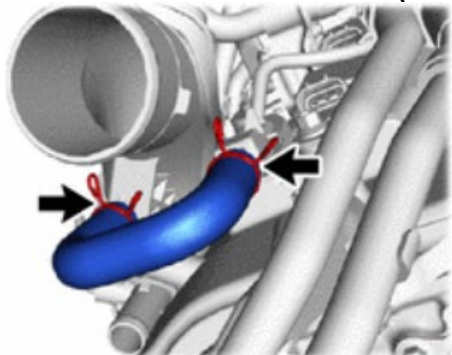

53. REMOVE NO. 1 AIR INLET DUCT

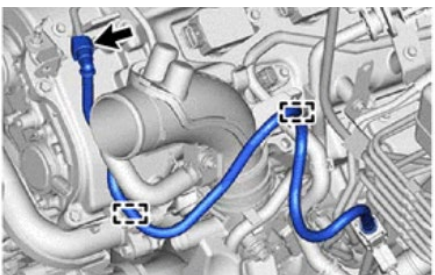

54. REMOVE FUEL TUBE SUB-ASSEMBLY

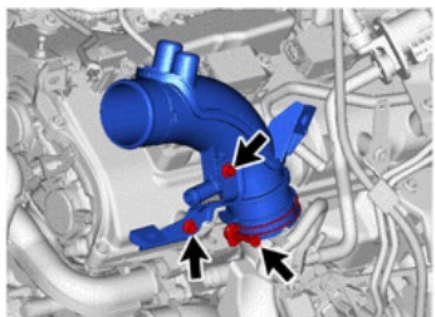

55. REMOVE NO. 2 AIR INLET DUCT

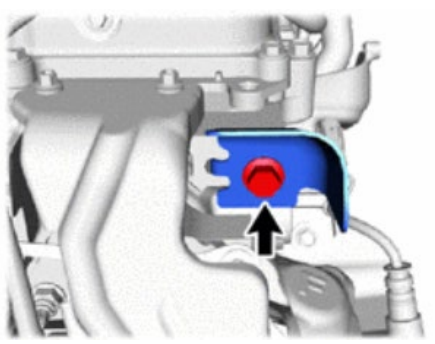

56. REMOVE NO. 6 TURBO INSULATOR

57. DISCONNECT ENGINE WIRE

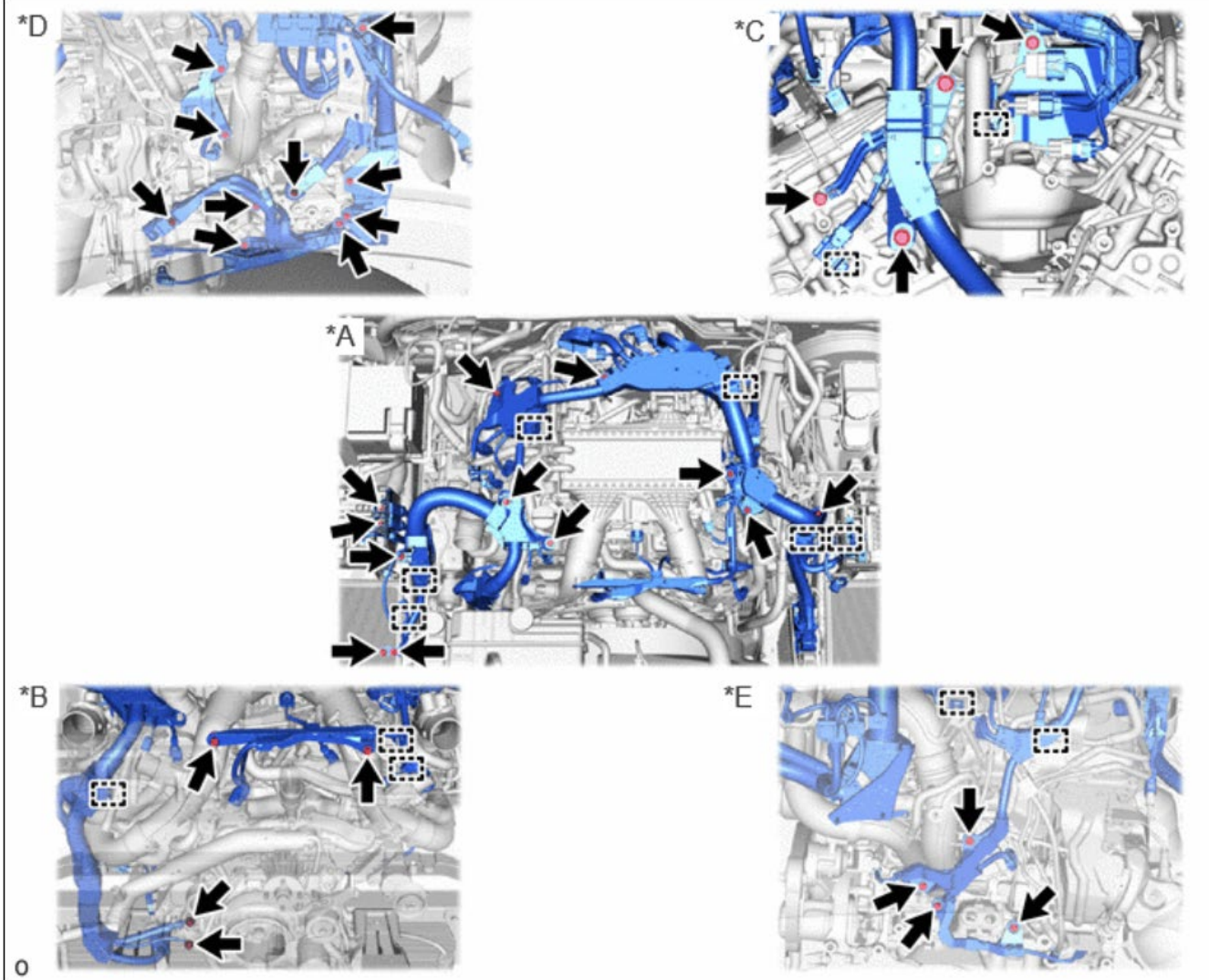

*A	for Upper Side	*B	for Front Side
*C	for Rear Side	*D	for RH Side
*E	for LH Side	-	-

58. INSTALL SST ENGINE HOOKS

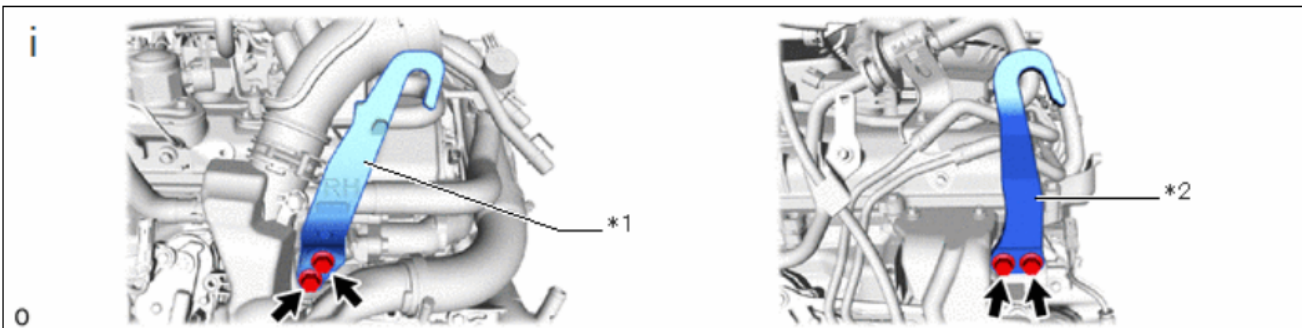

*1	No. 1 Engine Hanger	*2	No. 2 Engine Hanger
----	---------------------	----	---------------------

1. Install the No. 1 engine hanger and No. 2 engine hanger with the 4 bolts as shown in the illustration.

Part Description	Part Number
Service Engine Hook No. 1	12281-70080
Service Engine Hook No. 2	12282-70050
Service Engine Hook Bolts	90105-A0354

Torque:
43 N·m {438 kgf·cm, 32 ft·lbf}



59. DISCONNECT SUCTION HOSE SUB-ASSEMBLY

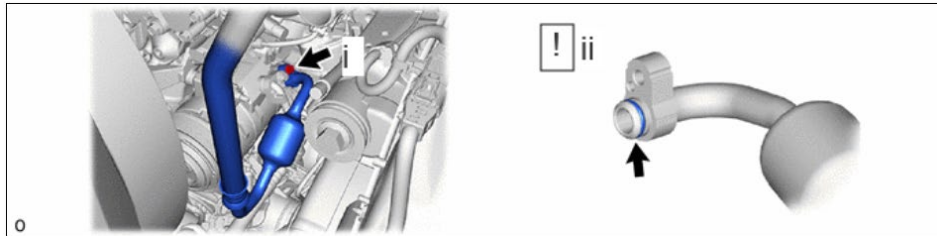

1. Remove the bolt and disconnect the suction hose sub-assembly.
2. Remove the O-ring from the suction hose sub-assembly.

60. DISCONNECT NO. 1 COOLER REFRIGERANT DISCHARGE HOSE



1. Disconnect the connector.
2. Remove the bolt and disconnect the No. 1 cooler refrigerant discharge hose.
3. Remove the O-ring from the No. 1 cooler refrigerant discharge hose.

NOTE: Seal the openings of the disconnected parts using vinyl tape to prevent moisture and foreign matter from entering them.

61. DISCONNECT AIR FUEL RATIO SENSOR

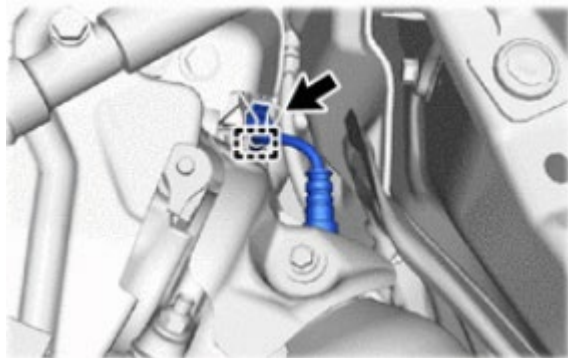

1. Disconnect the air fuel ratio sensor connector.
2. Detach the wire harness clamp.

62. DISCONNECT NO. 2 AIR FUEL RATIO SENSOR



1. Disconnect the No. 2 air fuel ratio sensor connector.
2. Detach the 4 wire harness clamps.

63. DISCONNECT NO. 3 AIR FUEL RATIO SENSOR

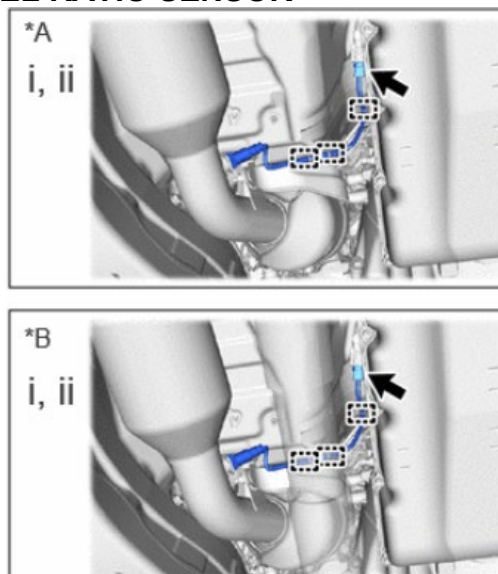

*A	for 2WD	*B	for 4WD
----	---------	----	---------

1. Disconnect the No. 3 air fuel ratio sensor connector.
2. Detach the 3 wire harness clamps.

64. DISCONNECT NO. 4 AIR FUEL RATIO SENSOR

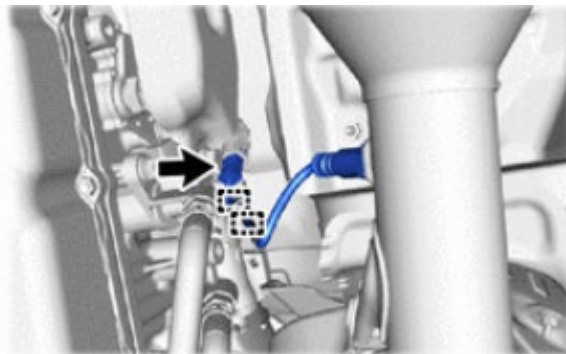

1. Disconnect the No. 4 air fuel ratio sensor connector.
2. Detach the 2 wire harness clamps.

65. REMOVE NO. 4 TURBO INSULATOR

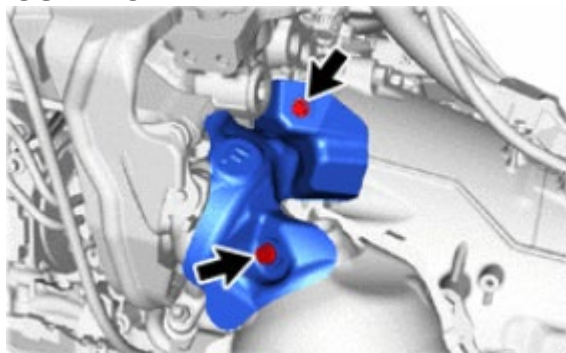

66. REMOVE NO. 2 TURBO INSULATOR

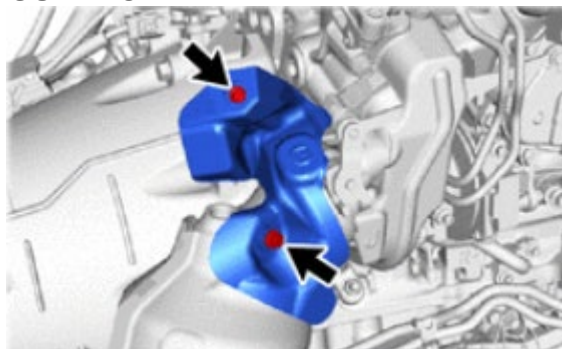

67. REMOVE CONVERTER WITH CATALYST ASSEMBLY LH

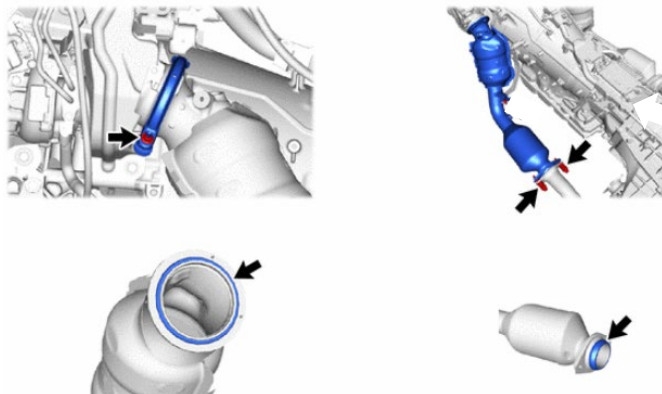

68. REMOVE CONVERTER WITH CATALYST ASSEMBLY RH

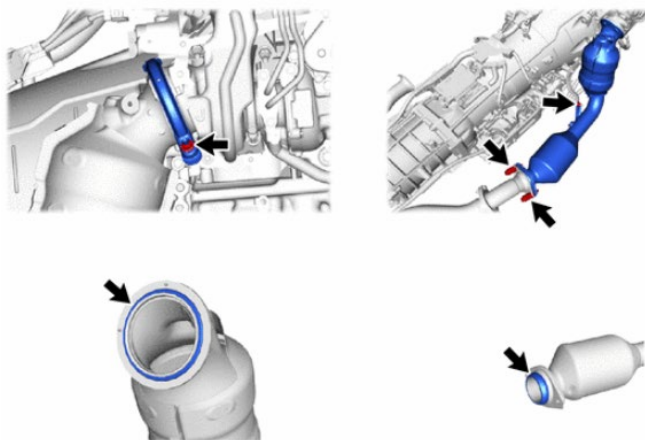

69. REMOVE NO. 2 MANIFOLD STAY

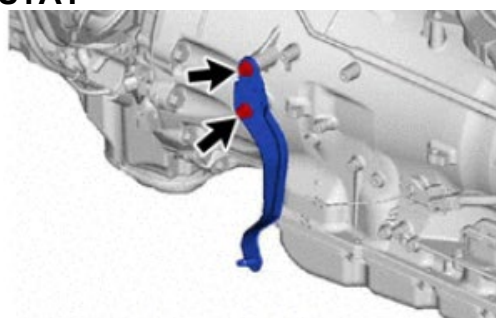

70. DISCONNECT TRANSMISSION WIRE HARNESS CONNECTIONS AND UNBOLT BRACKETS

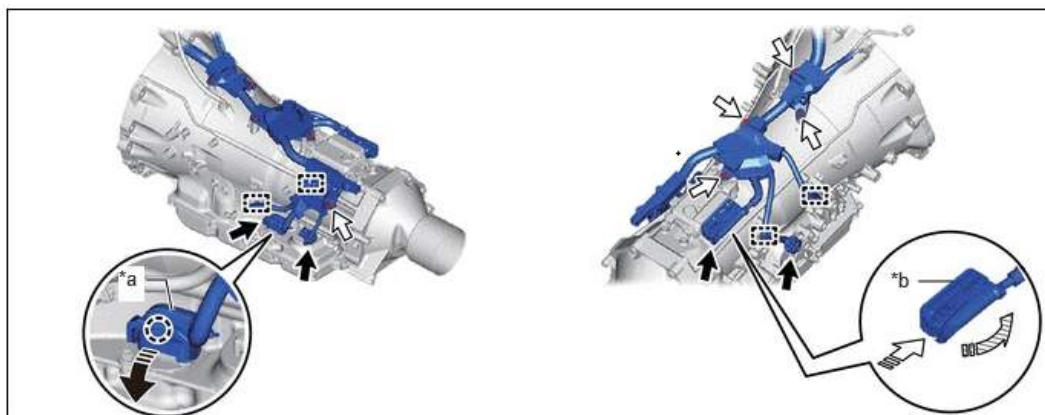

*a	Transmission Wire Connector	*b	TCM connector
	Connector		Bolt
	Pull Down the Lever		While Pressing the Lock
	Pull Up the Lever	-	-

71. REMOVE BELL HOUSING BOLTS

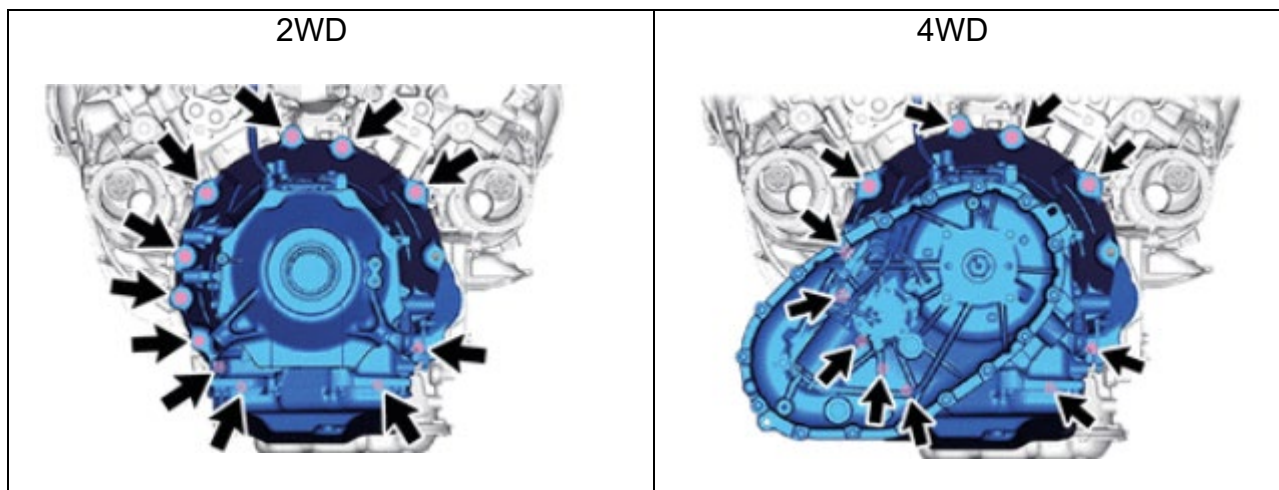

1. Remove the 11 bolts from the transmission assembly.

NOTE: Do not use excessive force to pry out the automatic transmission assembly with transfer assembly when separating it from the engine assembly to prevent the knock pins from being damaged.

72. REMOVE FLYWHEEL HOUSING SIDE COVER

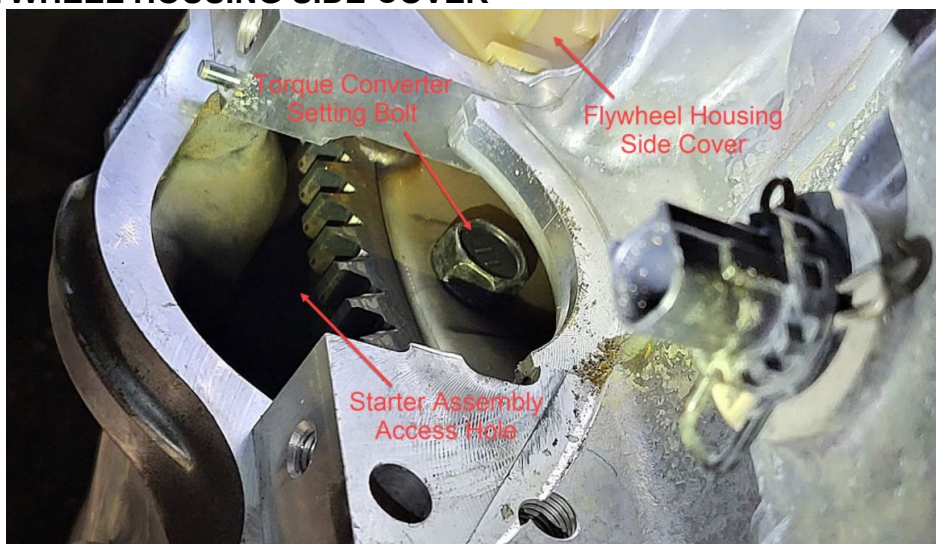

2. Remove the 6 drive plate and torque converter setting bolts from the drive plate and ring gear sub-assembly.

NOTE: Turn the crankshaft to a position where the drive plate and torque converter setting bolts can be removed and remove the drive plate and torque converter setting bolts while securing the crankshaft pulley bolt with a wrench.

73. SEIZED ENGINE REMOVAL



IF ENGINE IS NOT SEIZED (CAN BE TURNED OVER BY HAND) SKIP THIS STEP.

NOTICE: Confirm starter is functional by ensuring it will spin freely. If starter does not spin freely by hand, the starter will need to be replaced.

1. If engine is seized (cannot be turned over by hand), follow these steps:
 - a. Using pole jack, stabilize rear of the engine to prevent twisting/shifting of the engine mounts due to the weight of the torque converter when removing the transmission.

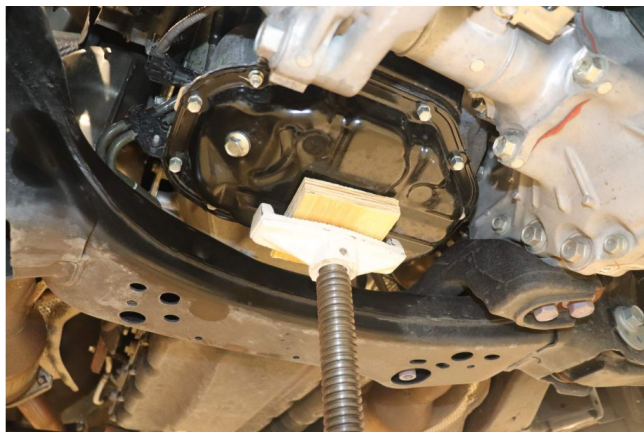

- b. Remove transmission while leaving torque converter attached to engine. Avoid excessive movement while removing transmission to avoid damage to the front pump.



c. Remove torque converter bolts using open ended wrench.



NOTICE: Carefully read the cautions written in the repair manual and perform the written instructions correctly.

74. PROTECT WINDSHIELD EDGE WITH PIPE INSULATOR.
Note: Use caution around the windshield defroster wire.

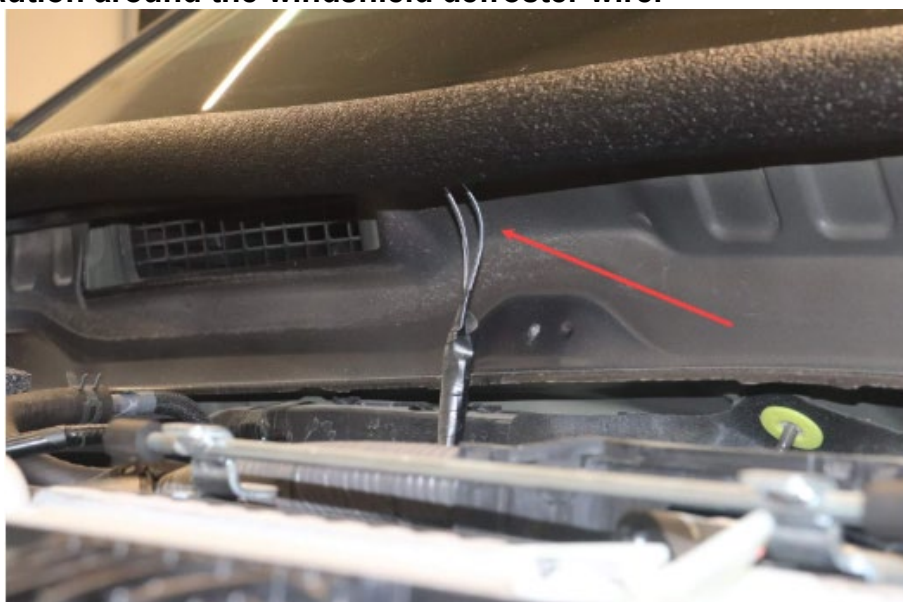

75. PROTECT RADIATOR FINS BY ADDING A CARDBOARD SHEET OR PLYWOOD COVER

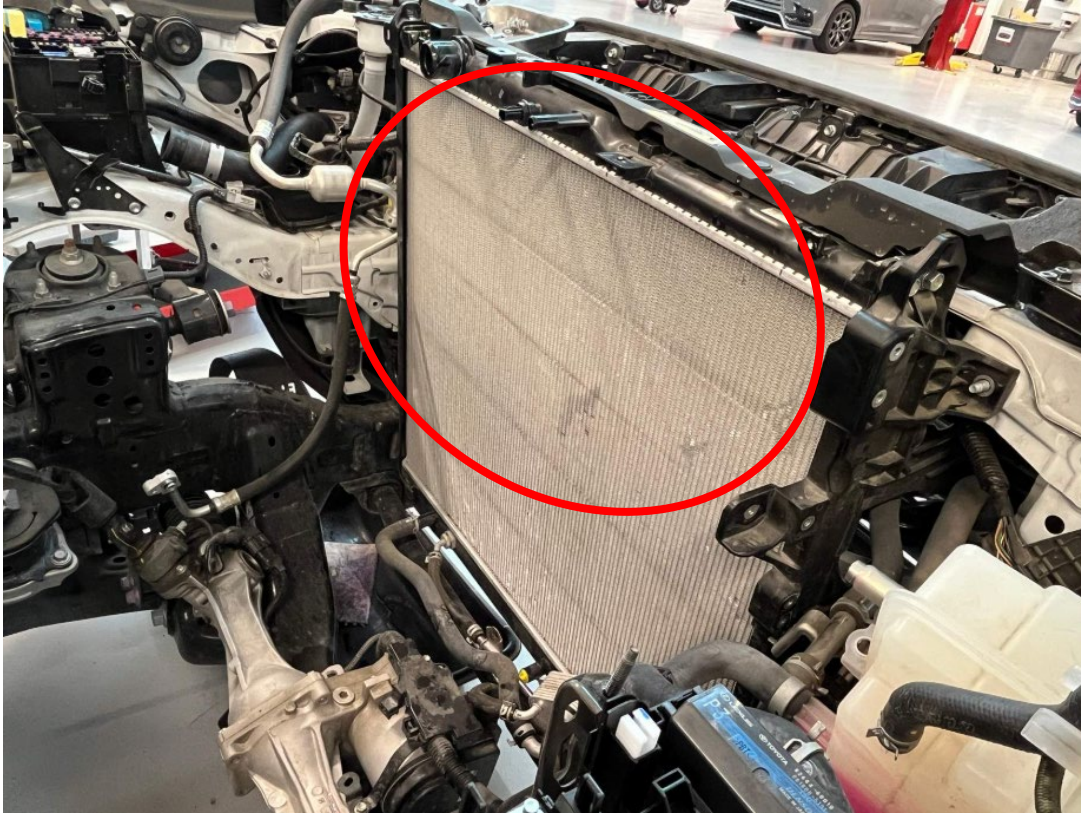

76. REMOVE ENGINE ASSEMBLY

NOTE: When attaching the engine lift chain to the engine crane boom-chain hook, make sure the entire chain link is placed inside the hook. Then, secure it by installing one or two through bolts of the appropriate size with a nut and washers to prevent any slipping while hoisting the engine as shown below.

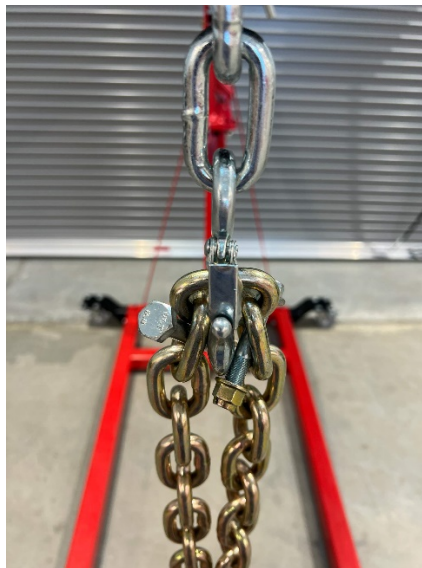

The chain must be centered, and the center of gravity set before installing the through bolts.

1. Attach an engine sling device and hang the engine with a chain block.
2. Remove the 4 bolts.

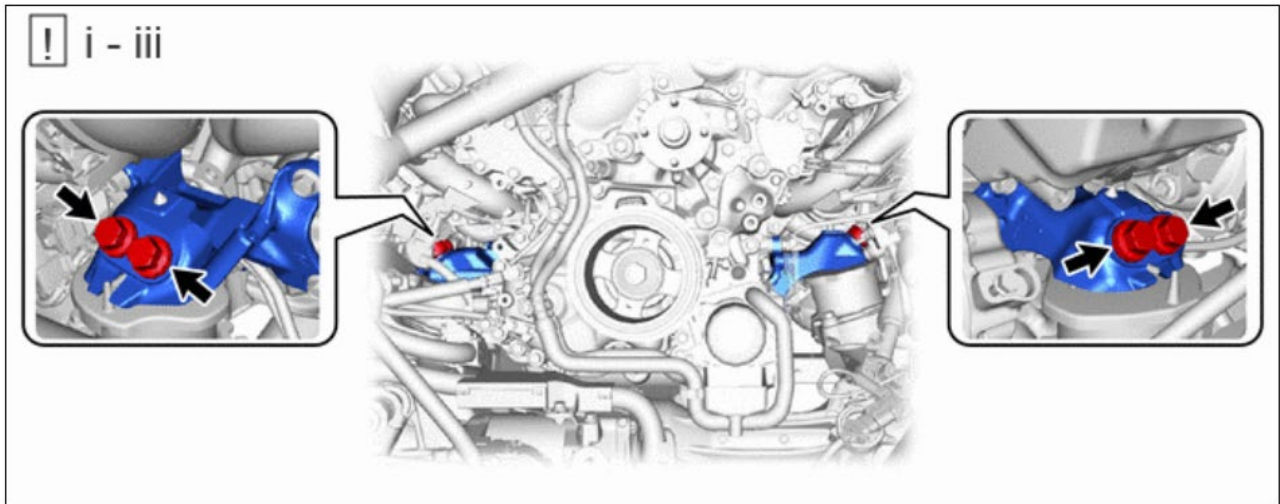

3. Remove the engine assembly by operating the engine sling device and chain block.

NOTE: Make sure that the engine is clear of all wiring and hoses. While removing the engine from the vehicle, do not allow it to contact the vehicle.

77. Transfer original components from original engine to new engine

- a. Transfer the following components from the **OLD** engine assembly to the **NEW** engine assembly.
 - Engine Wiring Harness
 - Generator
 - A/C Compressor
 - Drive Belt Tensioner
 - Drive Belts

1. REMOVE GENERATOR ASSEMBLY

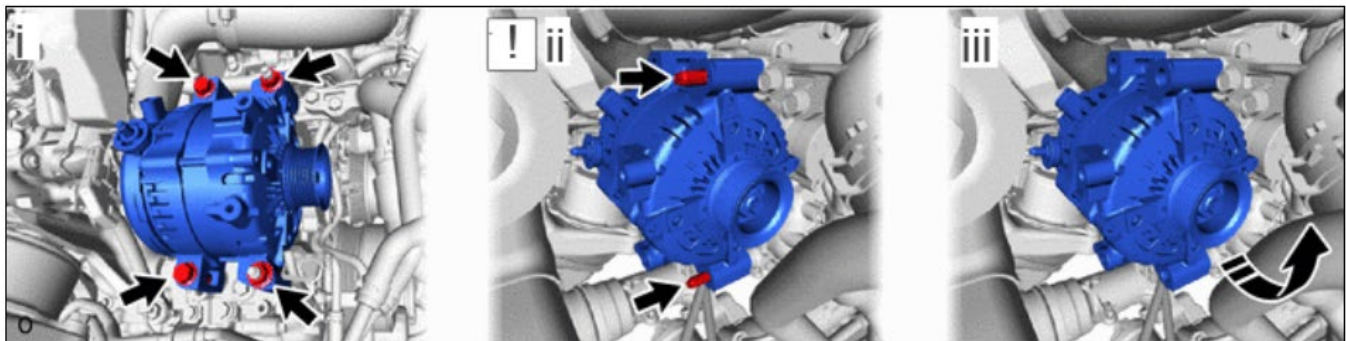

	Remove in this Direction	-	-
--	--------------------------	---	---

1. Remove the 2 bolts and 2 nuts.
2. Using an E8 "TORX" socket wrench, remove the 2 stud bolts and generator assembly.
3. Remove the generator assembly as shown in the illustration.

2. REMOVE COMPRESSOR WITH MAGNET CLUTCH

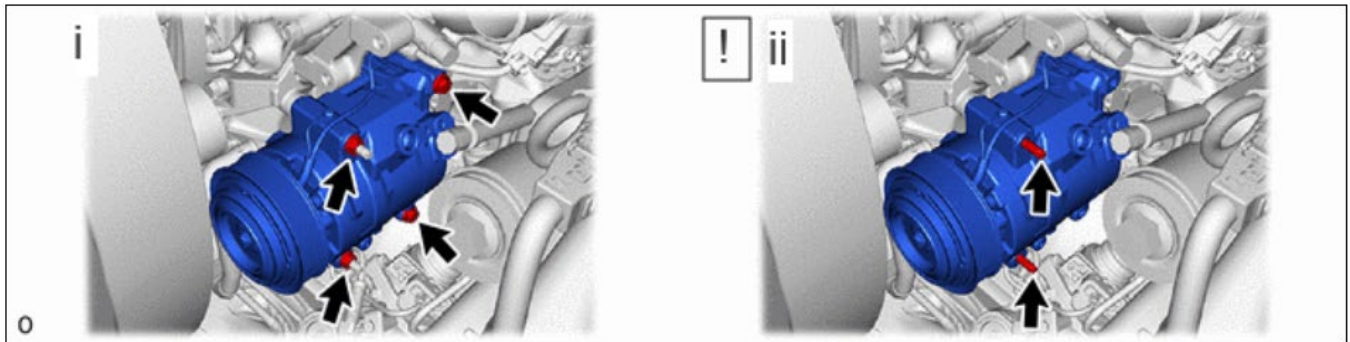

1. Remove the 2 bolts and 2 nuts.
2. Using an E8 "TORX" socket wrench, remove the 2 stud bolts and compressor with magnet clutch.

3. INSTALL COMPRESSOR WITH MAGNET CLUTCH

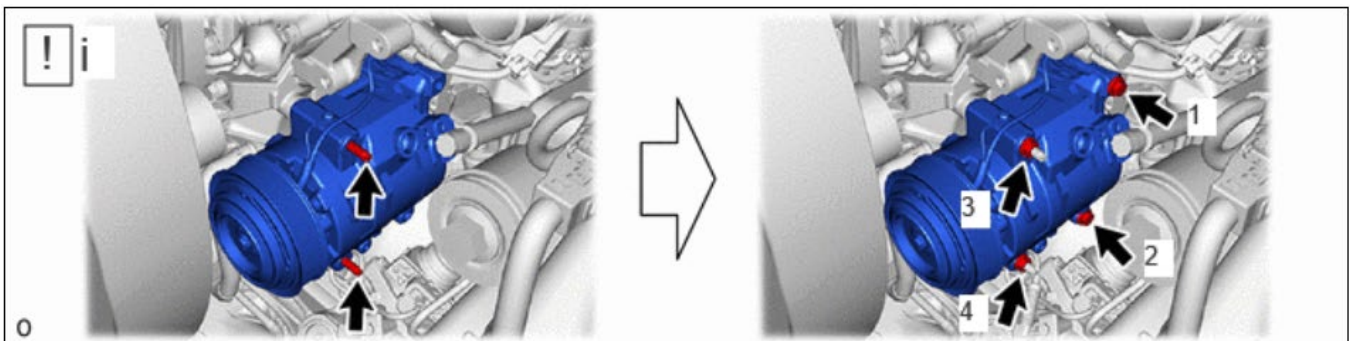

1. Using an E8 "TORX" socket wrench, temporarily install the compressor with magnet clutch with the 2 stud bolts.

Torque: 10 N·m {102 kgf·cm, 7 ft·lbf}

2. Install the compressor with magnet clutch with the 2 bolts and 2 nuts in the order shown in the illustration.

4. INSTALL GENERATOR ASSEMBLY



1. Using an E8 "TORX" socket wrench, temporarily install the generator assembly with the 2 stud bolts.

Torque: 10 N·m {102 kgf·cm, 7 ft·lbf}

2. Install the generator assembly with the 2 bolts and 2 nuts.

Torque: 43 N·m {438 kgf·cm, 32 ft·lbf}

1. **Open V35A-FTS Engine Serial Number Registration Website**

- a. Open the 24TA07 serial number registration website by selecting the following link:

<https://24ta07.imagespm.info/>

- b. Confirm language of website

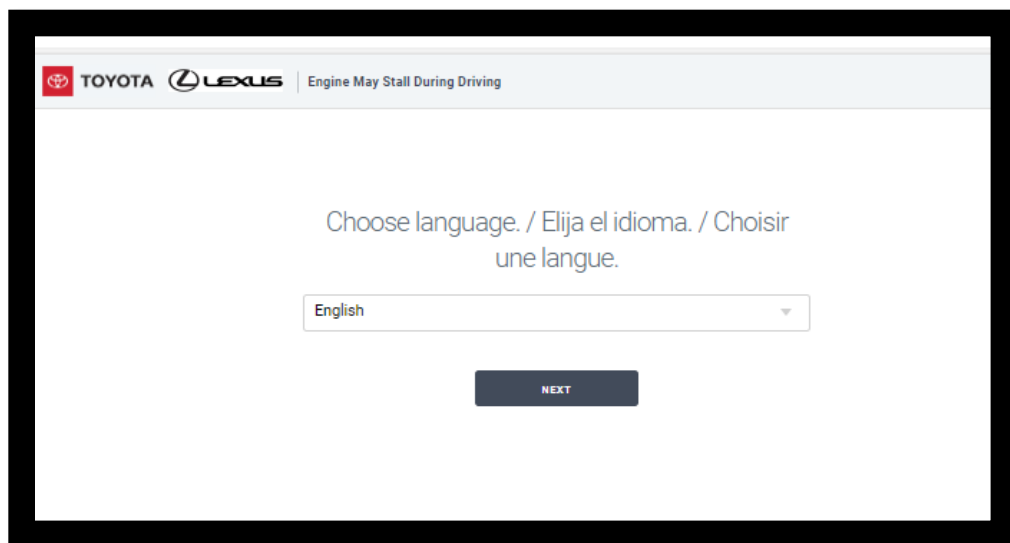

- c. Enter your dealer login credentials and follow the instructions to complete the engine serial number registration process.

Username: Dealer code

Password: XXXXX

Note: Default password is XXXXX. This password can be changed by the dealership after the first login. Please make sure all eligible technicians in your dealership know the password for your dealership.

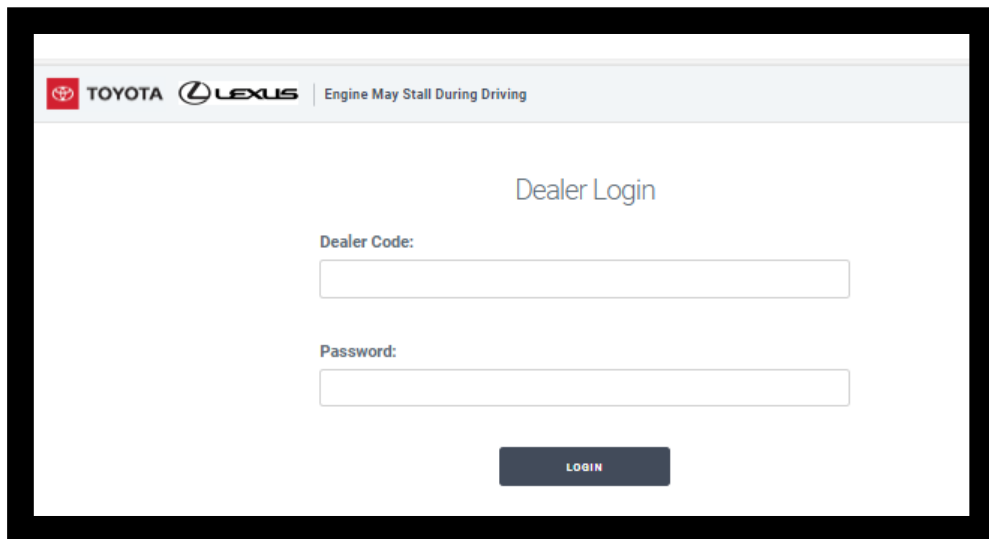

d. Enter VIN

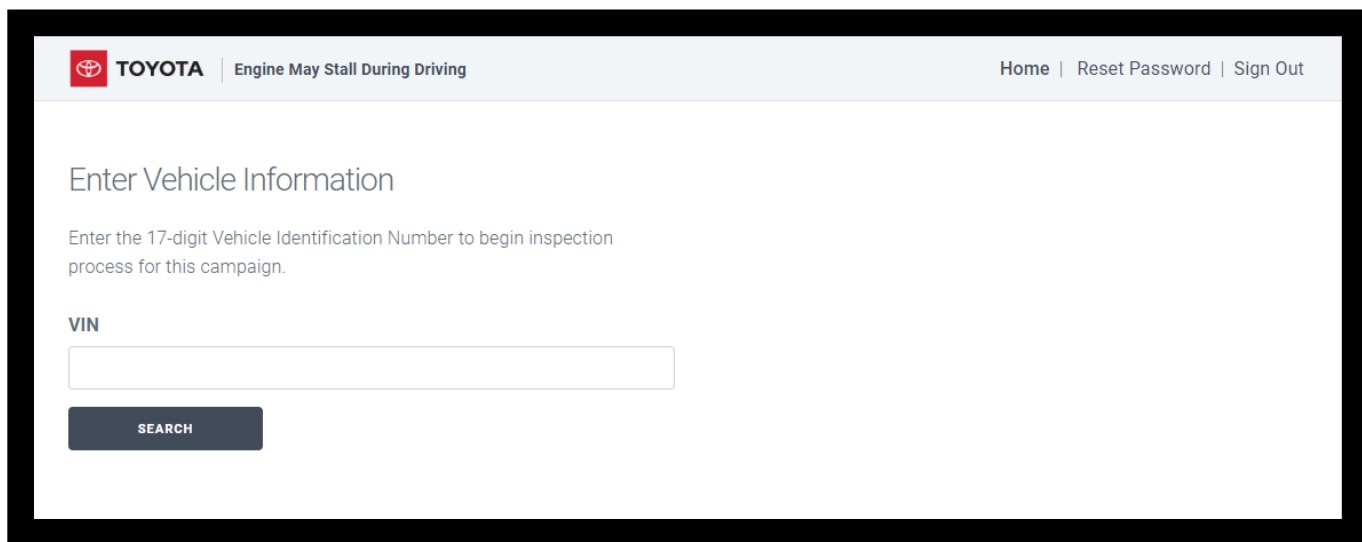

e. Register original and new engine serial numbers.

- i. Enter ***Original*** Engine Serial Number (can be found on front of engine block or on sticker on top of intercooler)
- ii. Upload photo of ***New*** Engine Serial Number
- iii. Scan ***New*** Engine Serial Number (can be found on sticker on top of intercooler)
- iv. Enter Technician Name
- v. Enter Technician Email
- vi. Enter Spin Number

NOTE: In order to register the serial number, the website requires a record of an engine being ordered for that VIN. If the VIN you enter goes to the parts order screen an engine has not yet been ordered for this vehicle.

TOYOTA Engine May Stall During Driving Home | Reset Password | Sign Out

Serial Number Registration

1. Enter Original Engine Serial Number



2. Upload Photo of Engine Serial Number (Confirm the picture is clear, see example above)

No file chosen



3. Scan New Engine Serial Number from Intercooler Barcode on top of engine (see example image above)

4. Technician Name

5. Technician Email

6. Technician SPIN Number

If the new engine serial number cannot be scanned in due to the intercooler label being damaged or missing, please contact quality_compliance@toyota.com with the following information:

- Dealer Code
- Technician Name
- SPIN Number
- Original Engine Serial Number on Block
- Photo of New Engine Serial Number on Block



If you have any issues, please email quality_compliance@toyota.com for further assistance.

f. Confirm all information was input correctly as shown below.

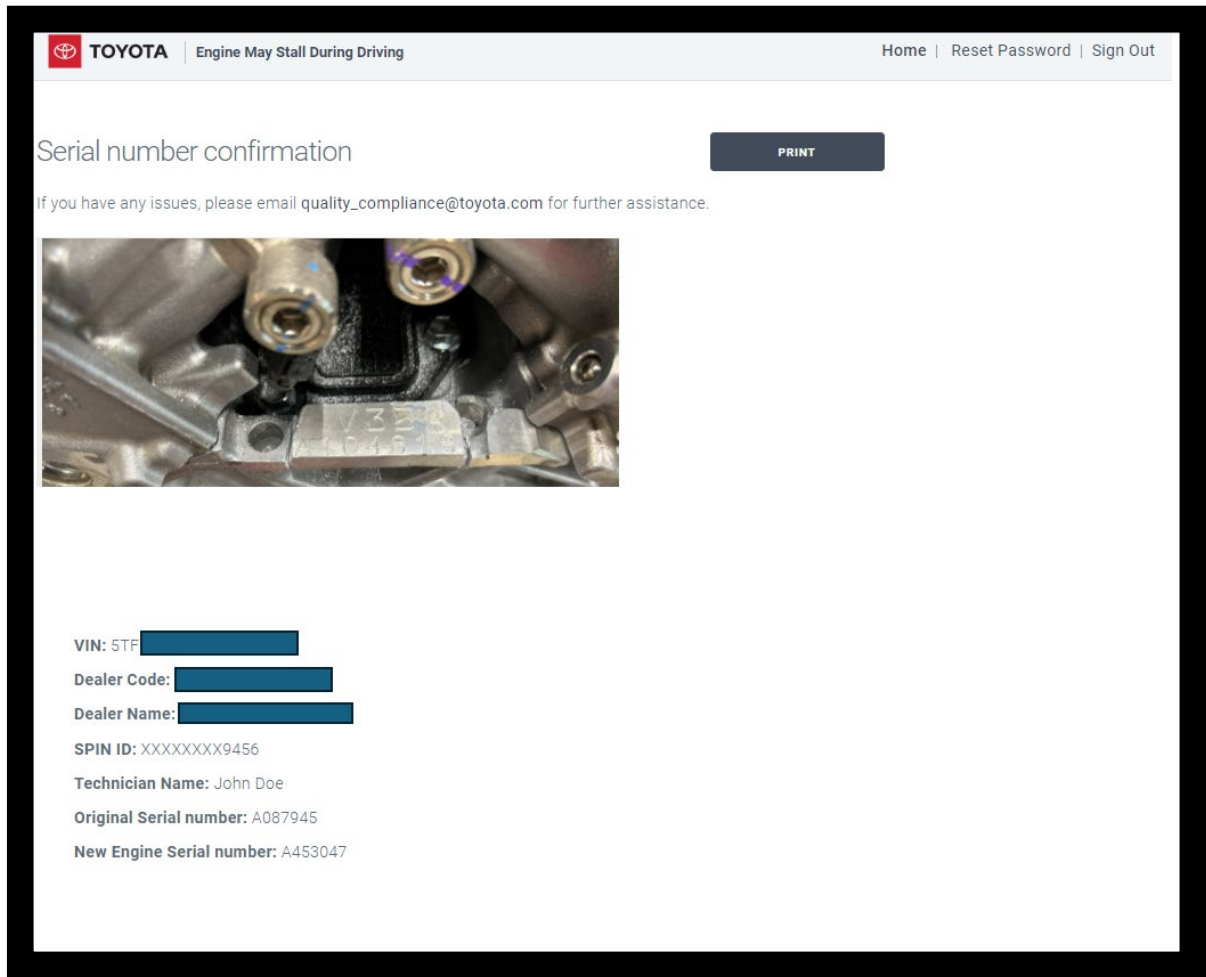

The screenshot shows a Toyota web portal interface. At the top left is the Toyota logo and the text "TOYOTA | Engine May Stall During Driving". At the top right are links for "Home | Reset Password | Sign Out". The main heading is "Serial number confirmation" with a "PRINT" button to its right. Below the heading is a message: "If you have any issues, please email quality_compliance@toyota.com for further assistance." A photograph of an engine block is shown, with a metal plate on the block containing the numbers "22" and "0769". Below the photo, the following information is displayed: "VIN: 5TF [redacted]", "Dealer Code: [redacted]", "Dealer Name: [redacted]", "SPIN ID: XXXXXXXX9456", "Technician Name: John Doe", "Original Serial number: A087945", and "New Engine Serial number: A453047".



Once a new engine serial number is registered to a VIN it must be used in that vehicle, no exceptions!

If you have any issues, please email quality_compliance@toyota.com for further assistance.

2. INSTALL ENGINE ASSEMBLY

NOTICE: Carefully read the cautions written in the repair manual and perform the written instructions correctly.



Ensure oil dip stick tube is not impacted during engine install. Impact to dip stick tube can cause tube to become unseated which can cause an oil leak. If you have any issues, please email quality_compliance@toyota.com for further assistance.



Ensure torque converter is seated correctly as shown below before installing engine assembly. If torque converter is not completely seated, damage may occur to transmission or engine. If you have any issues, please email quality_compliance@toyota.com for further assistance.

OK



NG

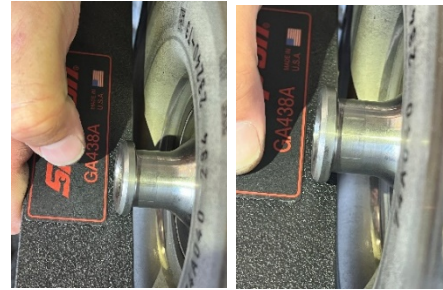

3. TRANSFER THE SST ENGINE HOOKS FROM THE OLD ENGINE ASSEMBLY TO THE NEW ENGINE ASSEMBLY.

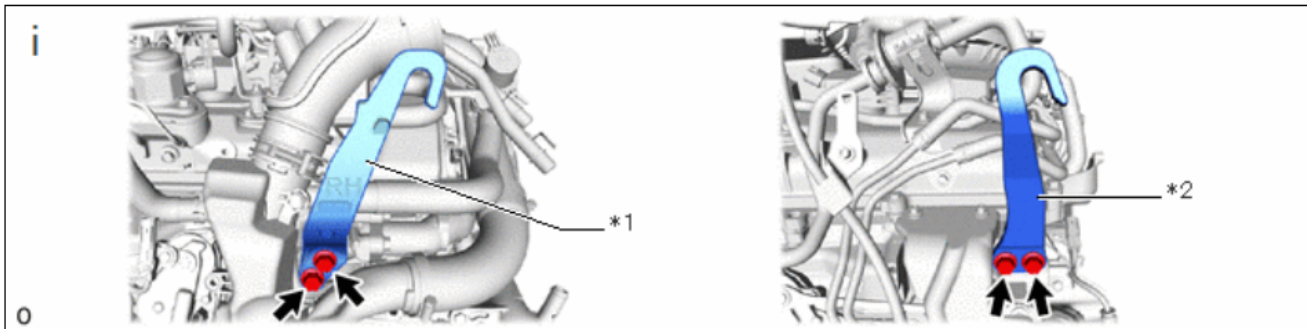

*1

No. 1 Engine Hanger

*2

No. 2 Engine Hanger

NOTE: DO NOT DISCARD HOOKS THAT CAME ON THE NEW ENGINE. THESE HOOKS ARE REQUIRED TO RETURN OLD ENGINE ASSEMBLY.

NOTE: Place service engine hooks in wooden crate temporarily while installing new engine.

a. Install the No. 1 engine hanger and No. 2 engine hanger with the 4 bolts as shown in the illustration.

Torque:

43 N·m {438 kgf·cm, 32 ft·lbf}

Correct Hooks for Use



Do Not Use



4. INSTALL ENGINE ASSEMBLY

! i, ii

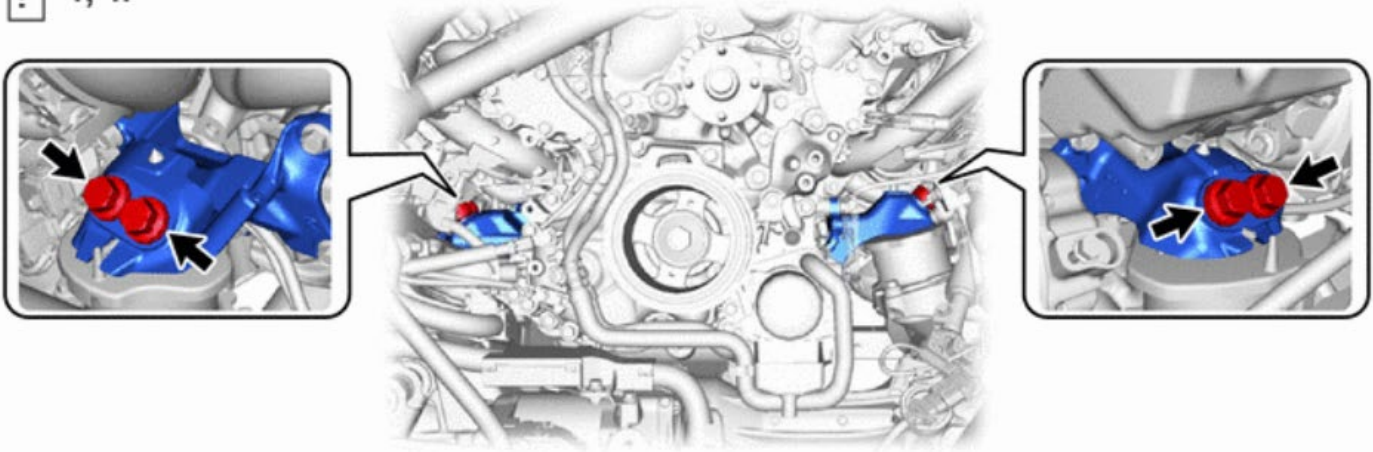





- a. Slowly lower the engine into the engine compartment.
- b. Install the front engine mounting insulator LH and front engine mounting insulator RH with the 4 bolts.

Torque: 150 N·m {1530 kgf·cm, 111 ft·lbf}

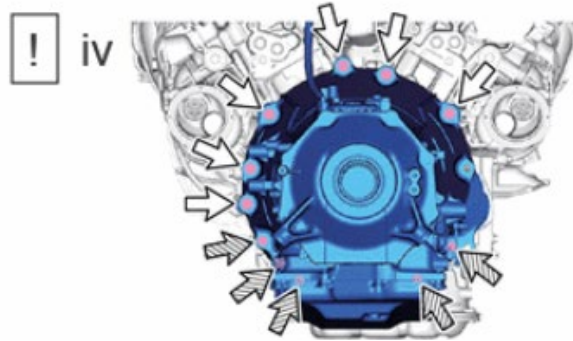
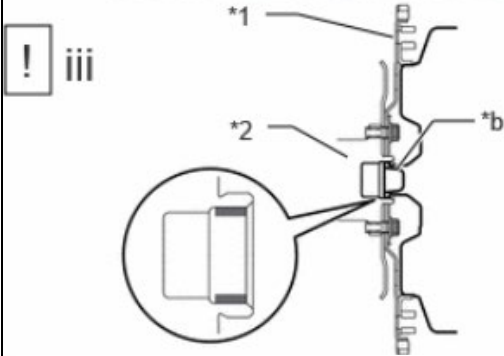
5. INSTALL BELL HOUSING BOLTS





2WD

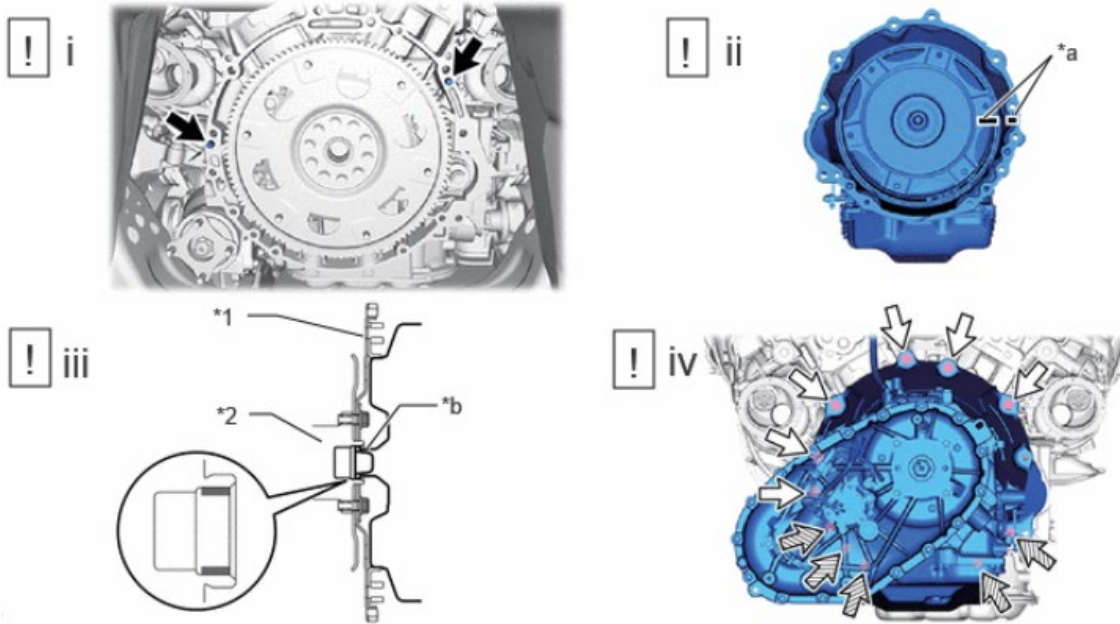

*1	Drive Plate	*2	Crankshaft
*a	Matchmark	*b	Torque Converter Assembly Centerpiece
	Knock Pin		Bolt A
	Bolt B		Clutch Spline Grease

4WD



*1	Drive Plate	*2	Crankshaft
*a	Matchmark	*b	Torque Converter Assembly Centerpiece
	Knock Pin		Bolt A
	Bolt B		Clutch Spline Grease

1. Confirm that the 2 knock pins are installed to the engine assembly and are not damaged.
2. Make sure that the matchmark is positioned as shown in the illustration.
3. Apply clutch spline grease to the surface the crankshaft that contacts the torque converter assembly centerpiece.

Clutch Spline Grease:
Toyota Genuine Clutch Spline Grease or equivalent
Maximum Grease Amount:
Approximately 1 g (0.0353 oz.)

4. While keeping the engine assembly and automatic transmission assembly horizontal, align the 2 knock pins with the holes in the automatic transmission assembly and install the automatic transmission assembly with the 11 bolts.

Torque:
for bolt A :
71 N·m {724 kgf·cm, 52 ft·lbf}
for bolt B :
37 N·m {377 kgf·cm, 27 ft·lbf}

NOTE:

- Do not use excessive force when installing the automatic transmission assembly.
- When mounting the automatic transmission assembly to the engine assembly, make sure to securely fit the 2 knock pins into the knock holes.
- When tightening the bolts, make sure that the contact surfaces of the engine assembly and the automatic transmission assembly are in close contact with one another.
- When installing the automatic transmission assembly, make sure that the oil cooler tube does not become damaged.
- Check that the torque converter assembly rotates smoothly after installation of the automatic transmission assembly.

Item	Length
Bolt A	50 mm (1.97 in.)
Bolt B	45 mm (1.77 in.)

6. INSTALL DRIVE PLATE AND TORQUE CONVERTER SETTING BOLT

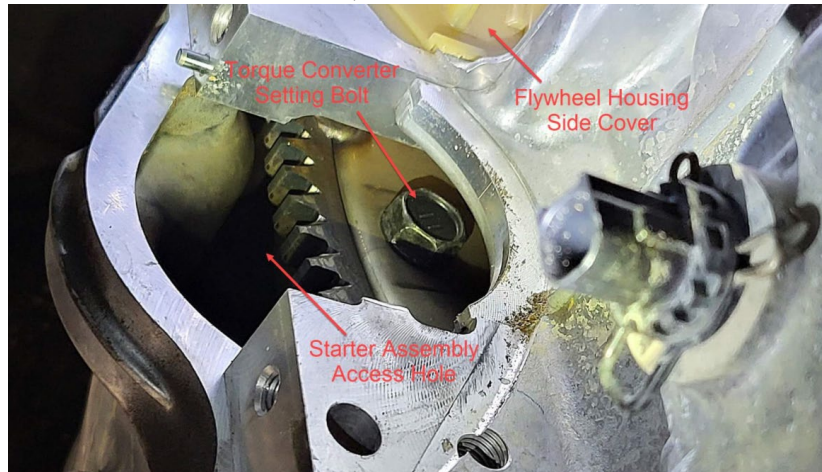

- a. Install the torque converter assembly to the drive plate and ring gear sub-assembly with the 6 drive plate and torque converter setting bolts.

Torque: 64 N·m {653 kgf·cm, 47 ft·lbf}

NOTE:

- Start by tightening the positioning drive plate and torque converter setting bolt (black), and then uniformly tighten the remaining 5 drive plate and torque converter setting bolts (silver).
- Turn the crankshaft to a position where the drive plate and torque converter setting bolts can be installed, and install the drive plate and torque converter setting bolts while securing the crankshaft pulley bolt with a wrench.

- b. Install flywheel housing cover

7. INSTALL STARTER ASSEMBLY

Torque:

Starter assembly : 46 N·m {469 kgf·cm, 34 ft·lbf}

Engine wire : 9.8 N·m {100 kgf·cm, 87 in·lbf}

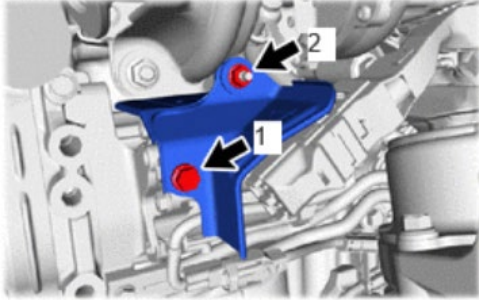

8. INSTALL STARTER COVER

- Temporarily install the starter cover with the bolt and nut.
- Tighten the bolt and nut in the order shown in the illustration.

Torque: 11.5 N·m {117 kgf·cm, 8 ft·lbf}

9. INSTALL CONVERTER WITH CATALYST ASSEMBLY RH

- Temporarily install a **NEW** gasket to the converter with catalyst assembly RH.
- Using a plastic-faced hammer and wooden block, tap in the gasket until its surface is flush with the converter with catalyst assembly RH.

! i, ii

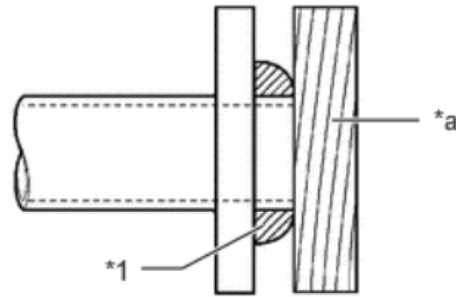

*1	Gasket	-	-
*a	Wooden Block	-	-

NOTE:

- Be sure to install the gasket so that it faces the correct direction.
- Do not reuse the OLD gasket.
- Do not damage the **NEW** gasket.

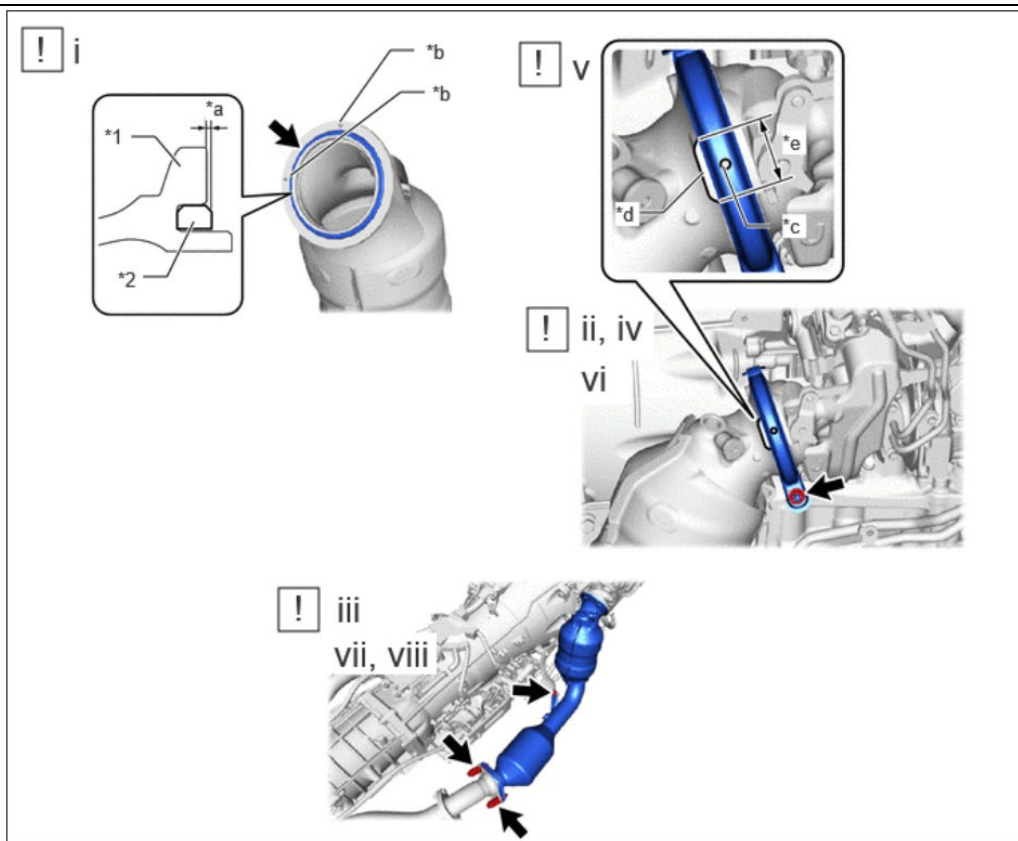

*1	Converter With Catalyst Assembly RH	*2	Turbine Outlet Elbow Gasket RH
*a	1.5 mm (0.0590 in.) or less	*b	Knock Pin
*c	Alignment Protrusion on Exhaust Pipe Clamp Side RH	*d	Alignment Protrusion on Converter With Catalyst Assembly RH Side
*e	Position Alignment Range	-	-

- c. Install a **NEW** turbine outlet elbow gasket RH to the converter with catalyst assembly RH as shown in the illustration.

NOTE: When reusing the converter with catalyst assembly RH, thoroughly clean the gasket groove so that no old gasket remains. Fully insert the **NEW** gasket into the gasket groove of the converter with catalyst assembly RH.

- d. Set a **NEW** exhaust pipe clamp RH to the converter with catalyst assembly RH.

NOTE: Make sure the end of the exhaust pipe clamp RH does not open 140 mm (5.51 in.) or more (standard amount approximately 60 mm (2.36 in.)).

- e. Temporarily install the converter with catalyst assembly RH to the manifold stay with the nut.

NOTE: Tighten the nut by hand until it contacts the surface.

- f. Align the converter with catalyst assembly RH with the knock hole on the No. 2 turbocharger sub-assembly side to connect the converter with catalyst assembly RH.

NOTE: Make sure that there is a knock pin on the converter with catalyst assembly RH.

- g. Align the flange surfaces of the No. 2 turbocharger sub-assembly and converter with catalyst assembly RH, and then temporarily install the exhaust pipe clamp RH.

NOTE: Make sure that there is a knock pin on the converter with catalyst assembly RH.

- h. Align the position alignment protrusions on the exhaust pipe clamp RH side to within the range of the position alignment protrusions on the converter with catalyst assembly RH side.
i. Tighten the exhaust pipe clamp RH.

Torque: 25 N·m {255 kgf·cm, 18 ft·lbf}

- j. Tighten the nut.

Torque: 43 N·m {438 kgf·cm, 32 ft·lbf}

- k. Connect the converter with catalyst assembly RH to the front exhaust pipe assembly with the 2 compression springs and 2 bolts.

Torque: 43 N·m {438 kgf·cm, 32 ft·lbf}

10. INSTALL CONVERTER WITH CATALYST ASSEMBLY LH

- a. Temporarily install a **NEW** gasket to the converter with catalyst assembly LH.
b. Using a plastic-faced hammer and wooden block, tap in the gasket until its surface is flush with the converter with catalyst assembly LH.

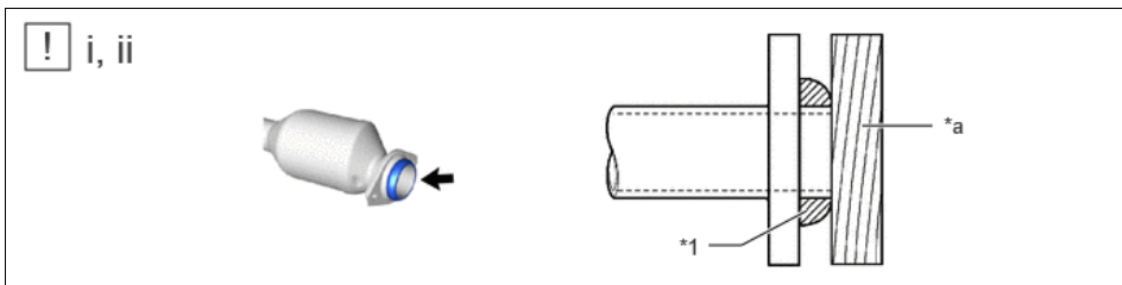

*1	Gasket	-	-
*a	Wooden Block	-	-

NOTE:

- Be sure to install the gasket so that it faces the correct direction.
- Do not reuse the OLD gasket.
- Do not damage the **NEW** gasket.

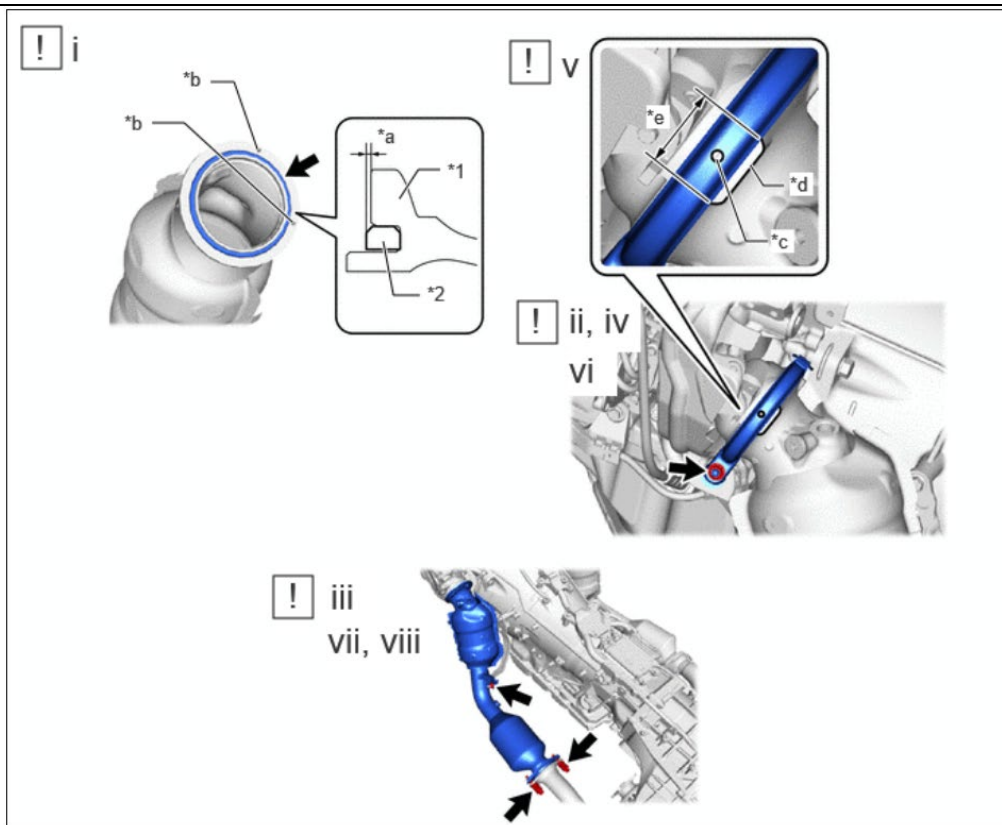

*1	Converter With Catalyst Assembly LH	*2	Turbine Outlet Elbow Gasket LH
*a	1.5 mm (0.0590 in.) or less	*b	Knock Pin
*c	Alignment Protrusion on Exhaust Pipe Clamp Side LH	*d	Alignment Protrusion on Converter With Catalyst Assembly LH Side
*e	Position Alignment Range	-	-

- c. Install a **NEW** turbine outlet elbow gasket LH to the converter with catalyst assembly LH as shown in the illustration.

NOTE: When reusing the converter with catalyst assembly RH, thoroughly clean the gasket groove so that no old gasket remains. Fully insert the **NEW** gasket into the gasket groove of the converter with catalyst assembly LH.

- d. Set a **NEW** exhaust pipe clamp LH to the converter with catalyst assembly LH.

NOTE: Make sure the end of the exhaust pipe clamp RH does not open 140 mm (5.51 in.) or more (standard amount approximately 60 mm (2.36 in.)).

- e. Temporarily install the converter with catalyst assembly LH to the manifold stay with the nut.

NOTE: Tighten the nut by hand until it contacts the surface.

- f. Align the converter with catalyst assembly LH with the knock hole on the No. 1 turbocharger sub-assembly side to connect the converter with catalyst assembly LH.

NOTE: Make sure that there is a knock pin on the converter with catalyst assembly LH.

- g. Align the flange surfaces of the No. 1 turbocharger sub-assembly and converter with catalyst assembly LH, and then temporarily install the exhaust pipe clamp LH.

NOTE: Make sure that there is a knock pin on the converter with catalyst assembly LH.

- h. Align the position alignment protrusions on the exhaust pipe clamp LH side to within the range of the position alignment protrusions on the converter with catalyst assembly LH side.
- i. Tighten the exhaust pipe clamp LH.

Torque: 25 N·m {255 kgf·cm, 18 ft·lbf}

- j. Tighten the nut.

Torque: 43 N·m {438 kgf·cm, 32 ft·lbf}

- k. Connect the converter with catalyst assembly LH to the front exhaust pipe assembly with the 2 compression springs and 2 bolts.

Torque: 43 N·m {438 kgf·cm, 32 ft·lbf}

11. CONNECT TRANSMISSION WIRE HARNESS CONNECTIONS AND BRACKETS

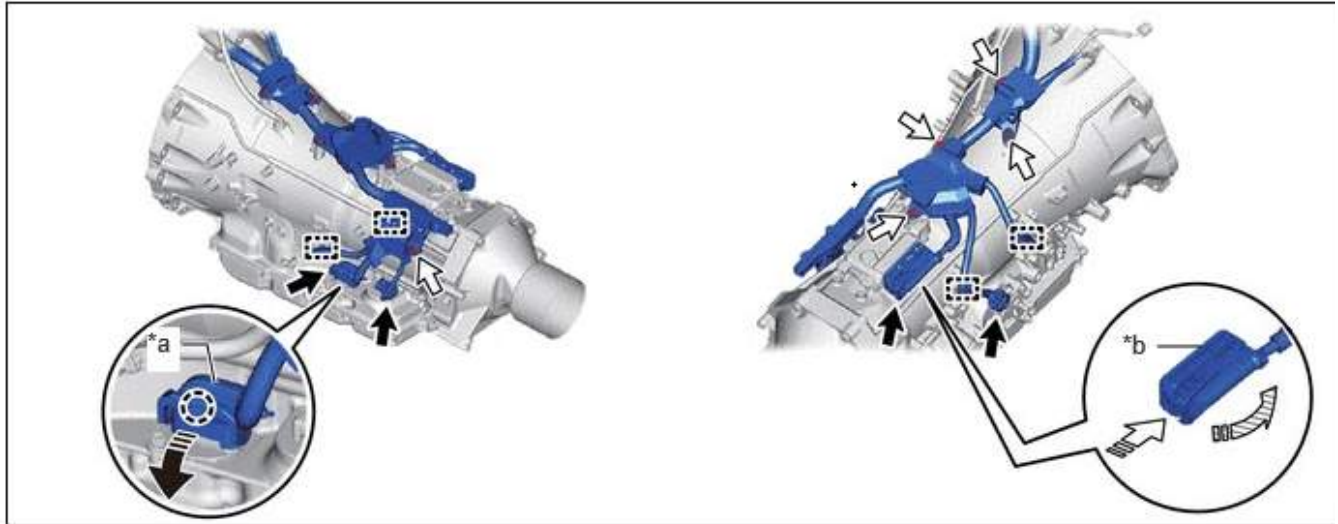

*a	Transmission Wire Connector	*b	TCM connector
	Connector		Bolt
	Pull Down the Lever		While Pressing the Lock
	Pull Up the Lever	-	-

12. INSTALL NO. 2 MANIFOLD STAY

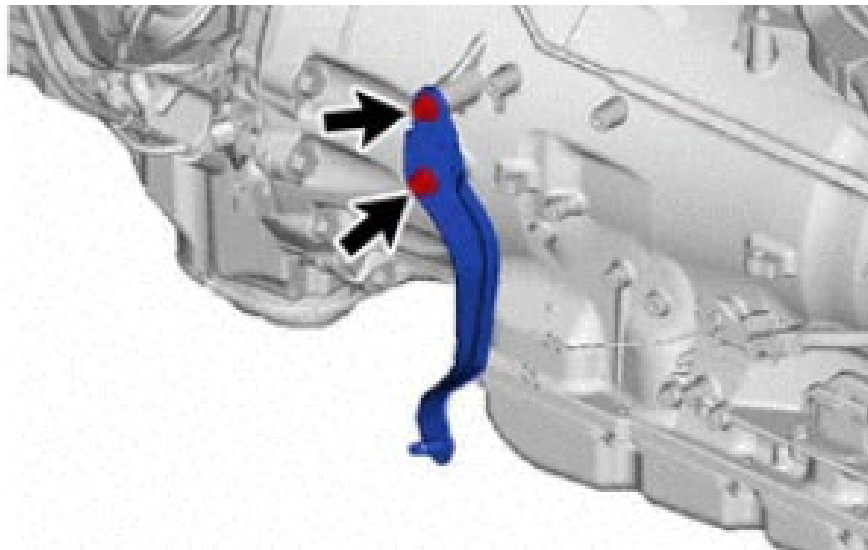

Torque: 43 N·m {438 kgf·cm, 32 ft·lbf}

13. CONNECT NO. 1 COOLER REFRIGERANT DISCHARGE HOSE

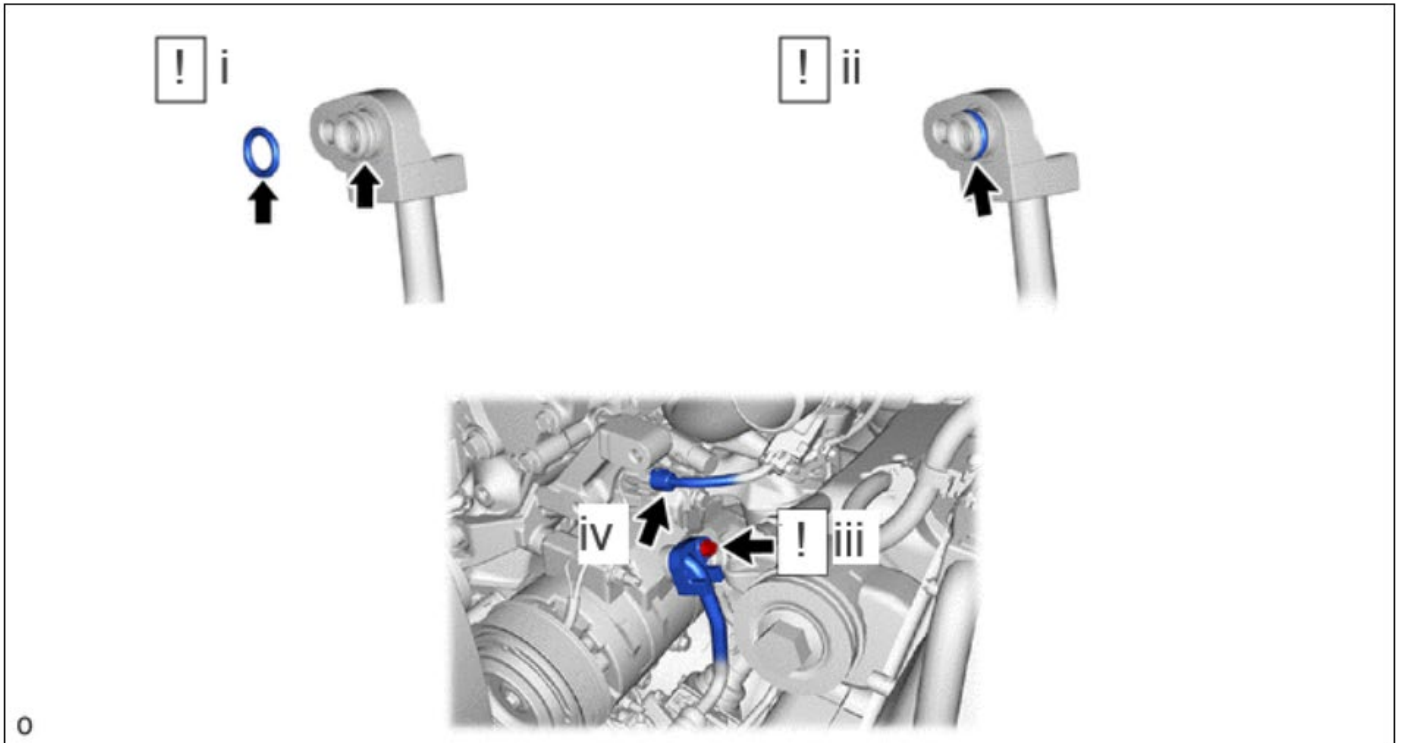

- a. Remove the vinyl tape from the No. 1 cooler refrigerant discharge hose and connecting part of the compressor with magnet clutch and then sufficiently apply compressor oil to a **NEW** O-ring and the fitting surface of the No. 1 cooler refrigerant discharge hose.

Compressor Oil: ND-OIL 12 or equivalent

- b. Install the **NEW** O-ring to the No. 1 cooler refrigerant discharge hose.

NOTICE: Keep the **NEW** O-ring and O-ring fitting surface free of foreign matter.

- c. Install the No. 1 cooler refrigerant discharge hose to the compressor with magnet clutch with the bolt.

Torque: 9.8 N·m {100 kgf·cm, 87 in·lbf}

NOTICE: Make sure not to cut the O-ring while installing it. (Cut O-rings cannot be installed.)

- d. Connect the connector.

14. CONNECT NO. 1 COOLER REFRIGERANT DISCHARGE HOSE

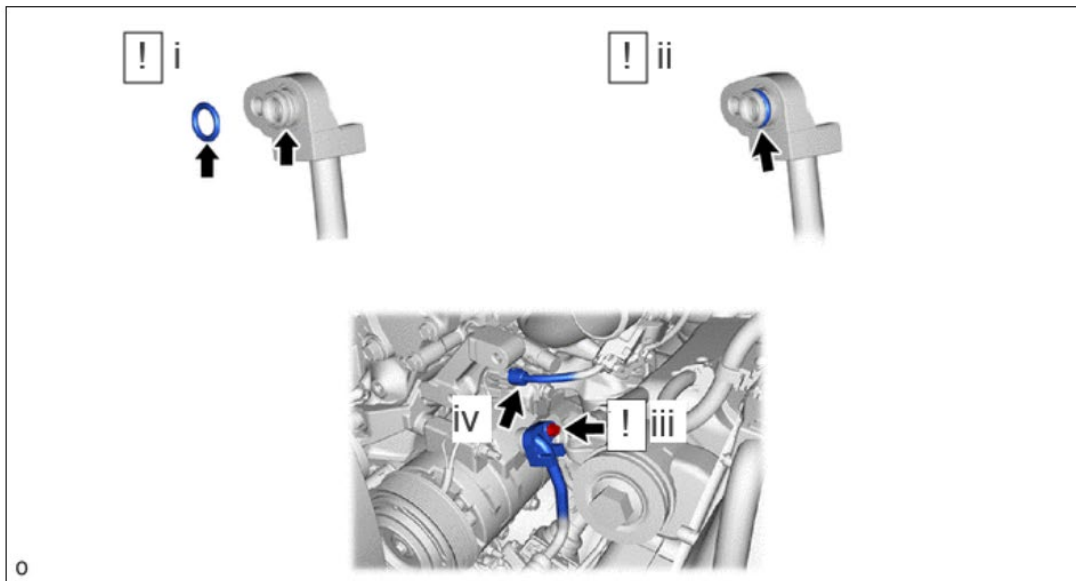

- a. Remove the vinyl tape from the suction hose sub-assembly and connecting part of the compressor with magnet clutch and then sufficiently apply compressor oil to a **NEW** O-ring and the fitting surface of the suction hose sub-assembly.

Compressor Oil: ND-OIL 12 or equivalent

- a. Install the **NEW** O-ring to the suction hose sub-assembly.

NOTICE: Keep the O-ring and O-ring fitting surface free of foreign matter.

- b. Install the suction hose sub-assembly to the compressor with magnet clutch with the bolt.

Torque: 9.8 N·m {100 kgf·cm, 87 in·lbf}

NOTICE: Make sure not to cut the O-ring while installing it. (Cut O-rings cannot be installed.)

15. REMOVE SST ENGINE HOOKS ON NEW ENGINE

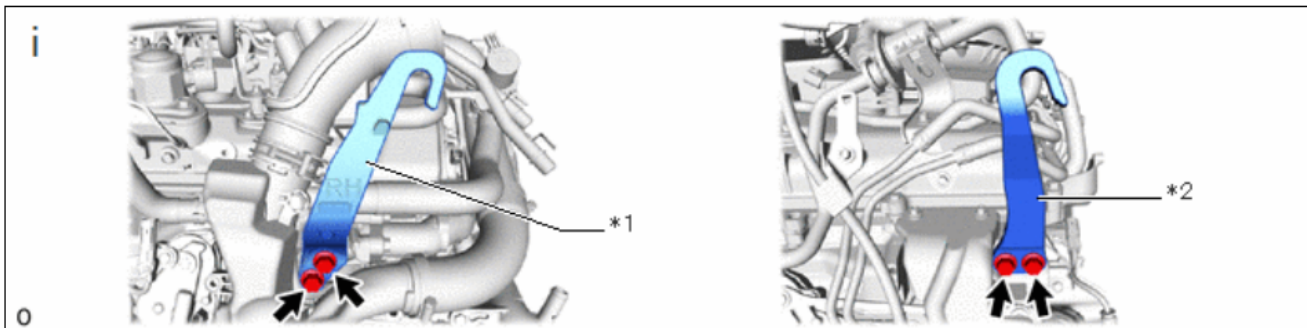

*1	No. 1 Engine Hanger	*2	No. 2 Engine Hanger
----	---------------------	----	---------------------

NOTE: DO NOT DISCARD ENGINE HOOKS.

- a. Remove the No. 1 engine hanger and No. 2 engine hanger with the 4 bolts as shown in the illustration.

16. CONNECT ENGINE WIRE

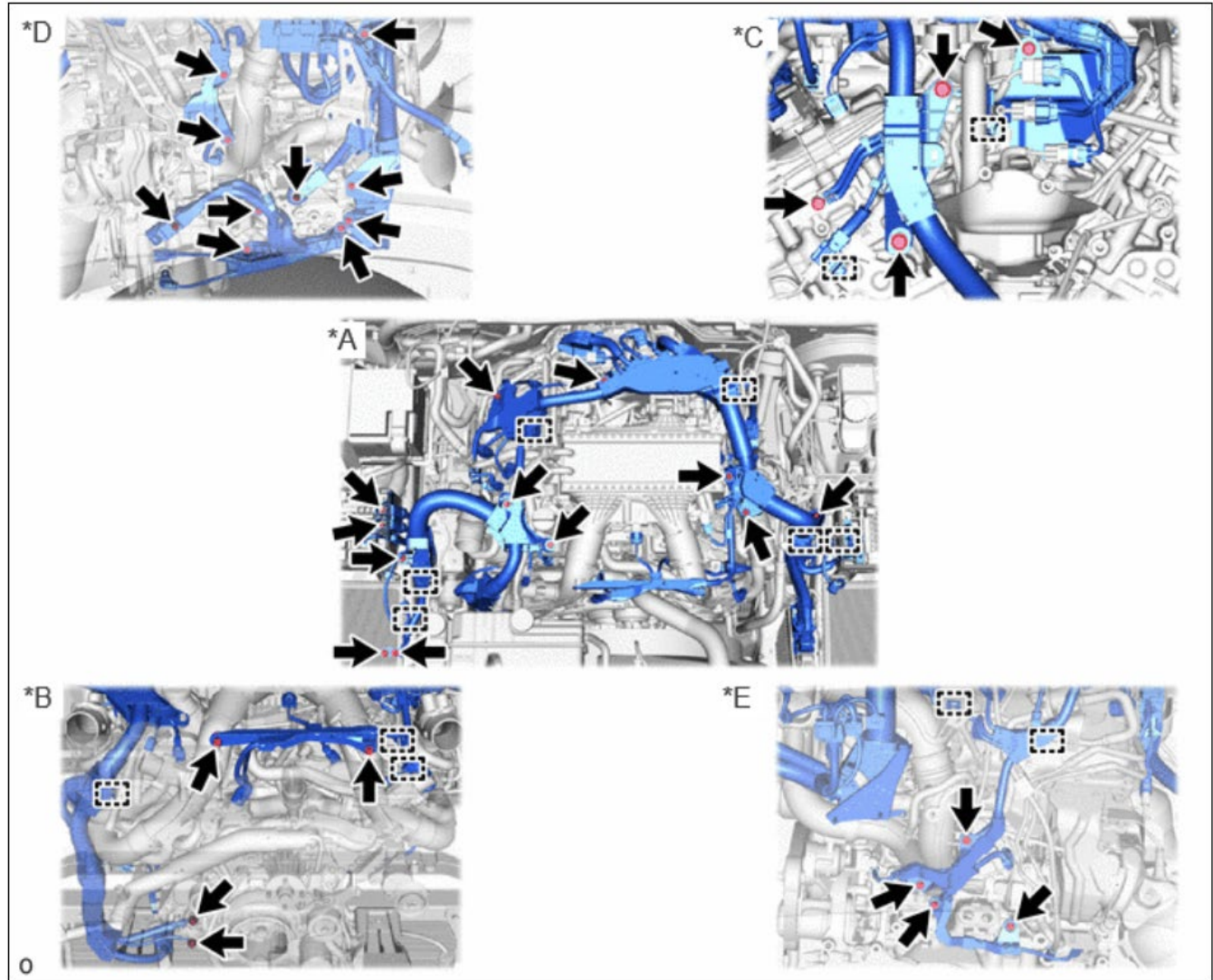

*A	for Upper Side	*B	for Front Side
*C	for Rear Side	*D	for RH Side
*E	for LH Side	-	-

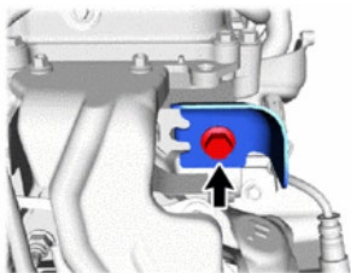

17. INSTALL NO. 6 TURBO INSULATOR

Torque: 25 N·m {255 kgf·cm, 18 ft·lbf}

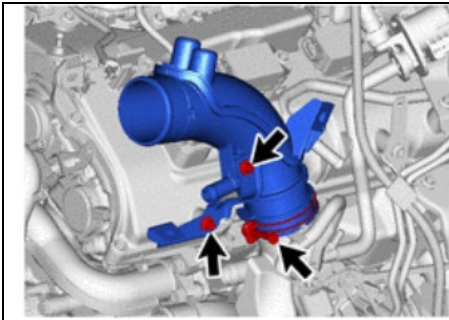

18. INSTALL NO. 2 AIR INLET DUCT

Torque:

bolt: 10 N·m {102 kgf·cm, 7 ft·lbf}

hose clamp: 4.0 N·m {41 kgf·cm, 35 in·lbf}

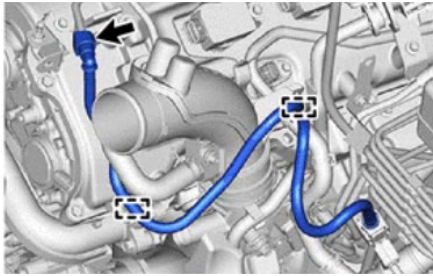

19. INSTALL FUEL TUBE SUB-ASSEMBLY

b. Connect the fuel tube sub-assembly.

c. Attach the 2 clamps and install the fuel tube sub-assembly.

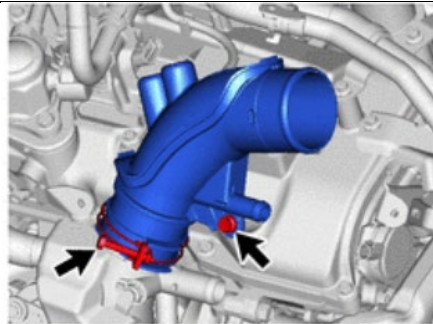

20. INSTALL NO. 1 AIR INLET DUCT

Torque:

bolt: 10 N·m {102 kgf·cm, 7 ft·lbf}

hose clamp: 4.0 N·m {41 kgf·cm, 35 in·lbf}

21. INSTALL NO. 2 PCV HOSE (NO. 2 VENTILATION HOSE)

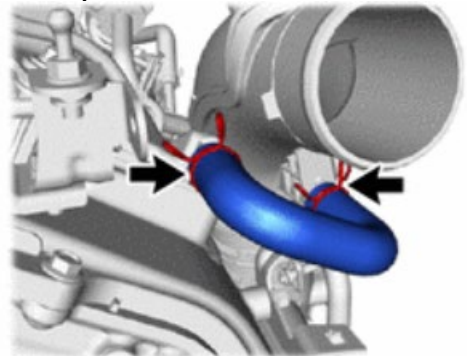
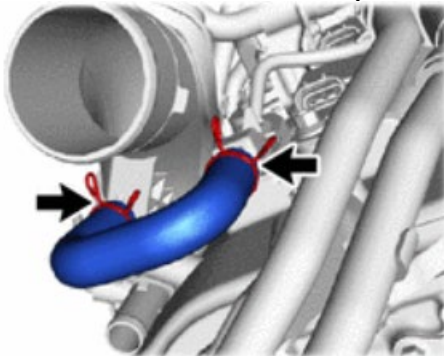

22. CONNECT FUEL TUBE SUB-ASSEMBLY

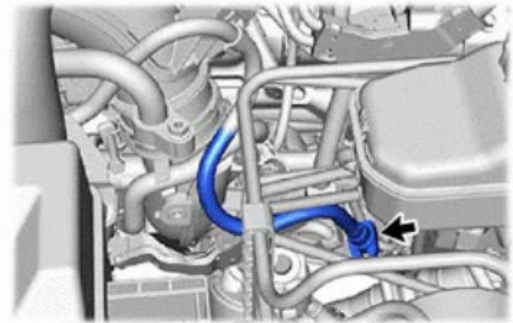
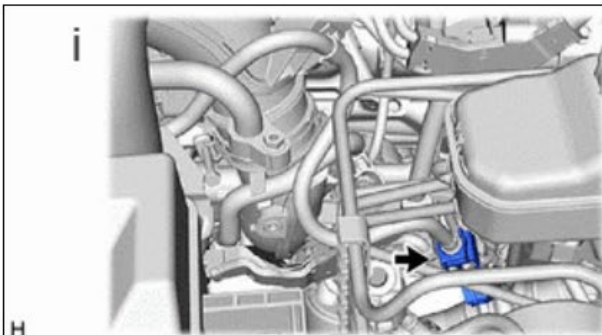

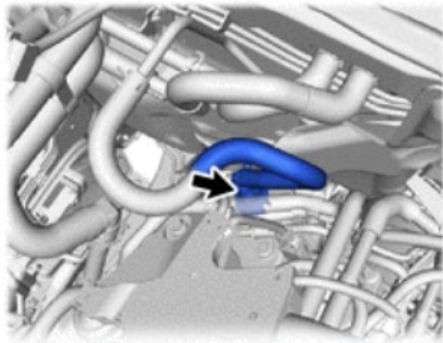

23. CONNECT NO. 1 VACUUM HOSE CONNECTOR

- a. Align the No. 1 vacuum hose connector with the vacuum pump assembly, and push them together until the No. 1 vacuum hose connector makes a "click" sound.

24. CONNECT OUTLET HEATER WATER HOSE B

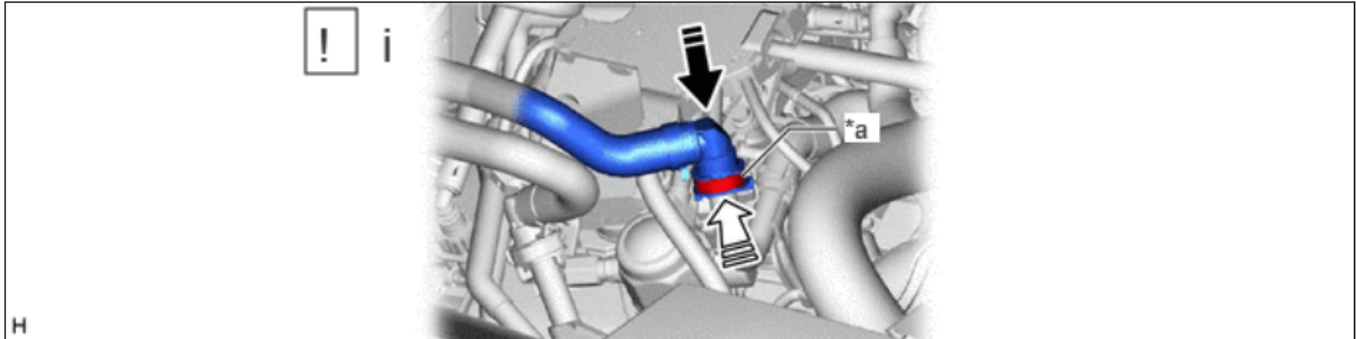

*a	Retainer	-	-
	Push		Push in

NOTE: Check that there is no damage or foreign matter on the connecting parts of the water lines.

- a. Connect the outlet heater water hose B connector to the No. 4 water by-pass pipe as shown in the illustration.
- b. Push in the retainer.
- c. Check that the No. 4 water by-pass pipe and outlet heater water hose B are securely connected by pulling on them.

25. CONNECT HEATER WATER HOSE L

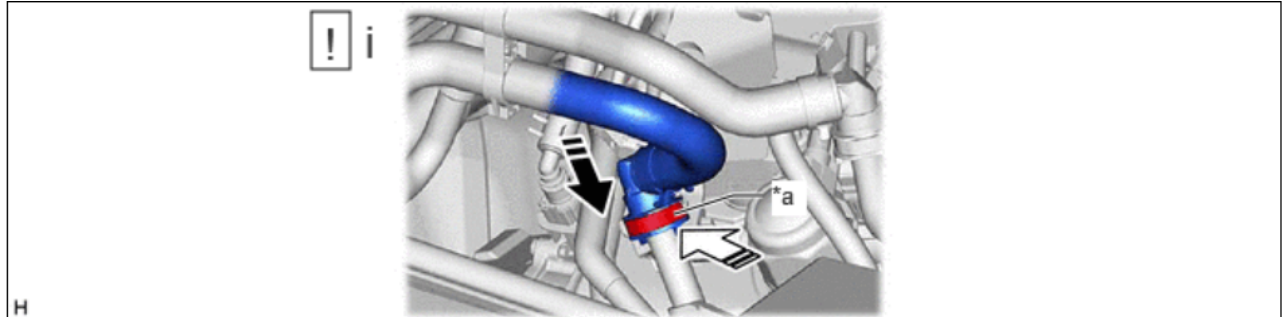

*a	Retainer	-	-
	Push		Push in

NOTE: Check that there is no damage or foreign matter on the connecting parts of the water lines.

- a. Connect the heater water hose L connector to the water by-pass pipe as shown in the illustration.
- b. Push in the retainer.
- c. Check that the No. 4 water by-pass pipe and outlet heater water hose B are securely connected by pulling on them.

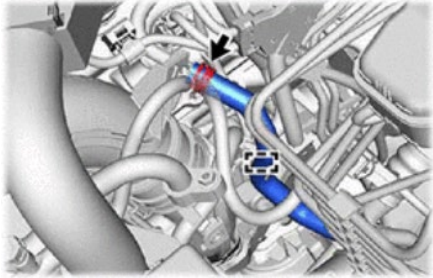

26. CONNECT NO. 1 FUEL VAPOR FEED HOSE

27. CONNECT ENGINE WIRE

*A

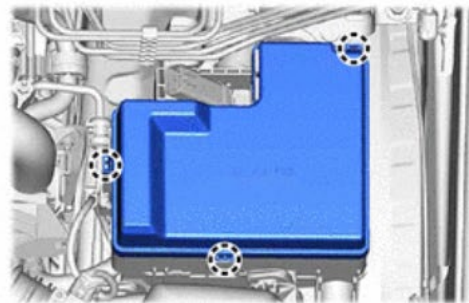
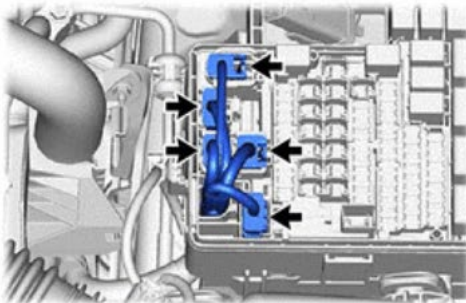
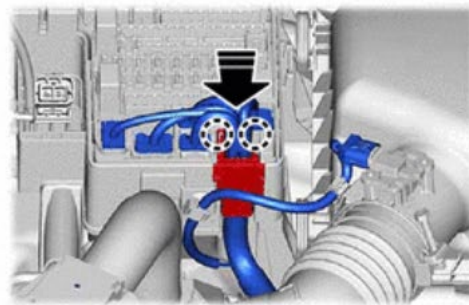

H

*A	for LH Side	-	-
----	-------------	---	---

Torque: 10 N·m {102 kgf·cm, 7 ft·lbf}

*A

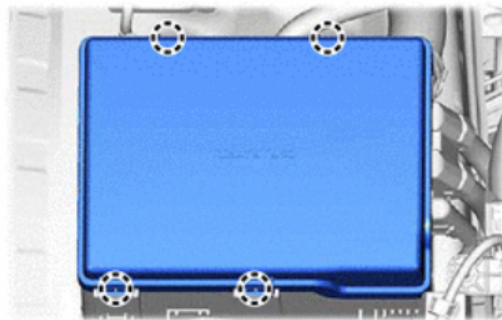
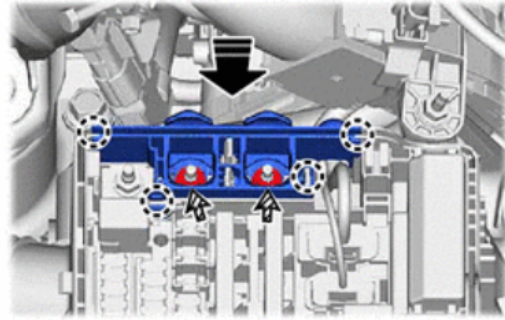
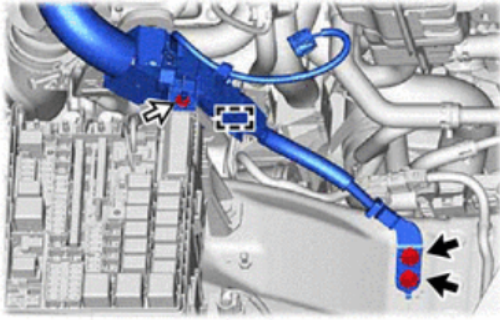

H

*A	for RH Side	-	-
	Bolt		Nut A
	Nut B	-	-

Torque:

bolt: 15 N·m {153 kgf·cm, 11 ft·lbf}

nut A: 10 N·m {102 kgf·cm, 7 ft·lbf}

nut B: 8.0 N·m {82 kgf·cm, 71 in·lbf}

28. CONNECT ECM

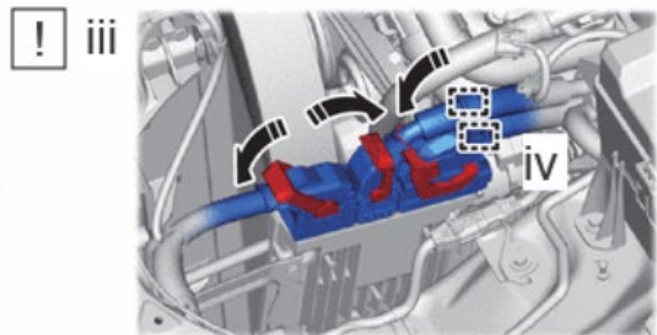
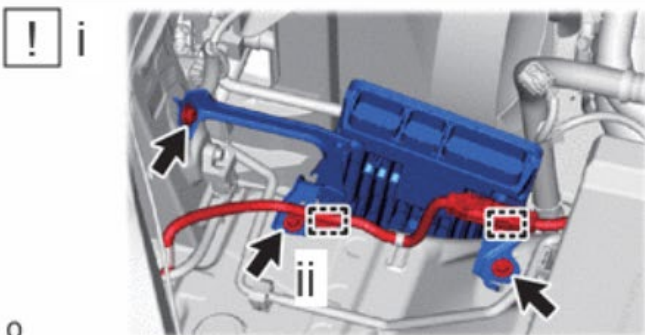

- a. Install the ECM with the 3 bolts.

Torque: 13 N·m {133 kgf·cm, 10 ft·lbf}

NOTE: If the ECM has been struck or dropped, replace it.

- b. Attach the 2 wire harness clamps.
- c. Connect the 3 connectors to the ECM and push down the lever to lock it.
- d. Attach the 2 wire connector clamps.

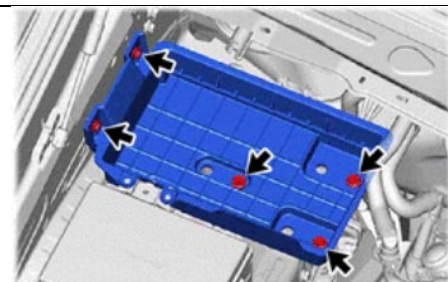

29. INSTALL BATTERY AND BATTERY CARRIER ASSEMBLY

Torque: 18.5 N·m {189 kgf·cm, 14 ft·lbf}

30. CONNECT NO. 4 WATER BY-PASS HOSE

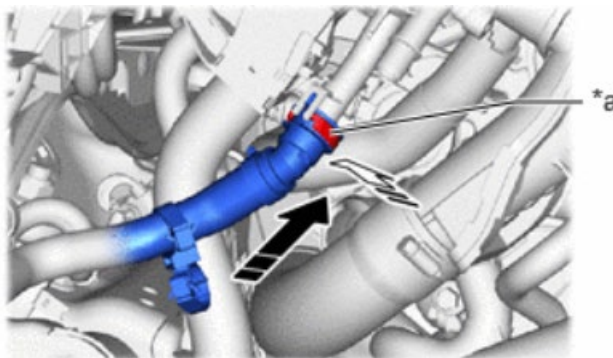

*a	Retainer	-	-
	Push		Push in

- a. Connect the No. 4 water by-pass hose assembly connector to the water by-pass hose assembly.

NOTE: Check that there is no damage or foreign matter on the connecting parts of the water lines.

- b. Align the protrusion of the water by-pass pipe assembly with the cutout in the No. 4 water by-pass hose assembly connector and securely insert the No. 4 water by-pass hose assembly connector to the stopper of the pipe.
- c. Push in the retainer.
- d. Check that the water by-pass pipe assembly and No. 4 water by-pass hose assembly connector are securely connected by pulling on them.

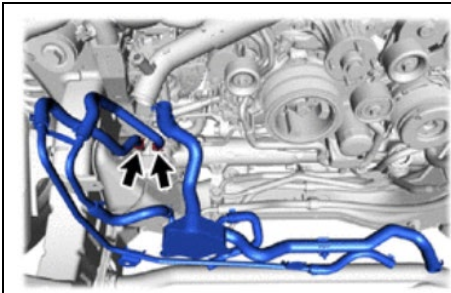

31. INSTALL OIL COOLER TUBE AND OIL COOLER HOSE WITH OIL COOLER ASSEMBLY

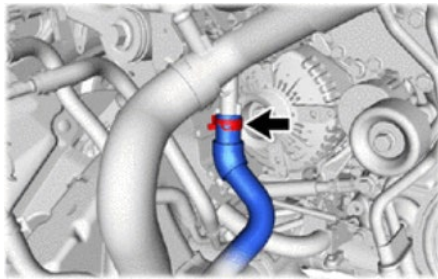

32. CONNECT NO. 3 WATER BY-PASS HOSE

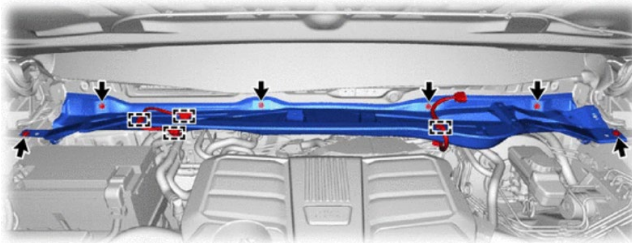

33. INSTALL OUTER COWL TOP PANEL SUB-ASSEMBLY

Torque: 7.5 N·m {76 kgf·cm, 66 in·lbf}

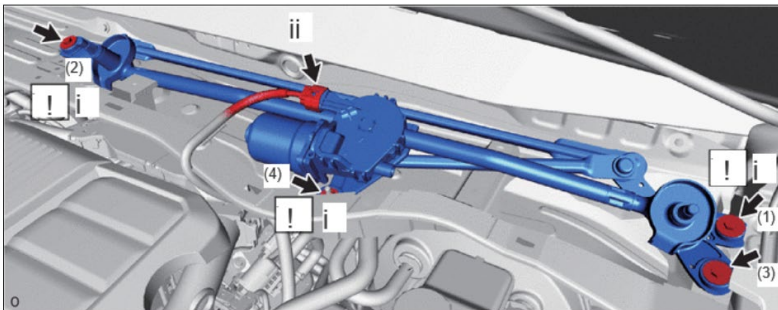

34. INSTALL WINDSHIELD WIPER MOTOR AND LINK ASSEMBLY

a. Install the windshield wiper motor and link assembly with the 3 bolts and nut in the order shown in the illustration.

Note: Do not damage the vehicle with the front wiper motor and link.

Torque: 7.5 N·m {76 kgf·cm, 66 in·lbf}

b. Connect the connector.

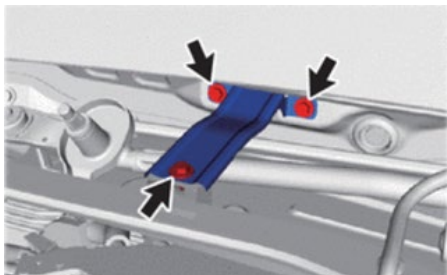

35. INSTALL INNER NO. 2 COWL TOP REINFORCEMENT

Torque: 7.5 N·m {76 kgf·cm, 66 in·lbf}

36. INSTALL COWL TOP VENTILATOR LOUVER SUB-ASSEMBLY

Note: To prevent damage to the windshield glass, remove any foreign matter (sand, dust, etc.) from around the contacting surfaces of the cowl top ventilator louver sub-assembly and windshield glass.

37. INSTALL FRONT FENDER TO COWL SIDE SEAL RH & LH

38. INSTALL FRONT WIPER ARM AND BLADE ASSEMBLY RH

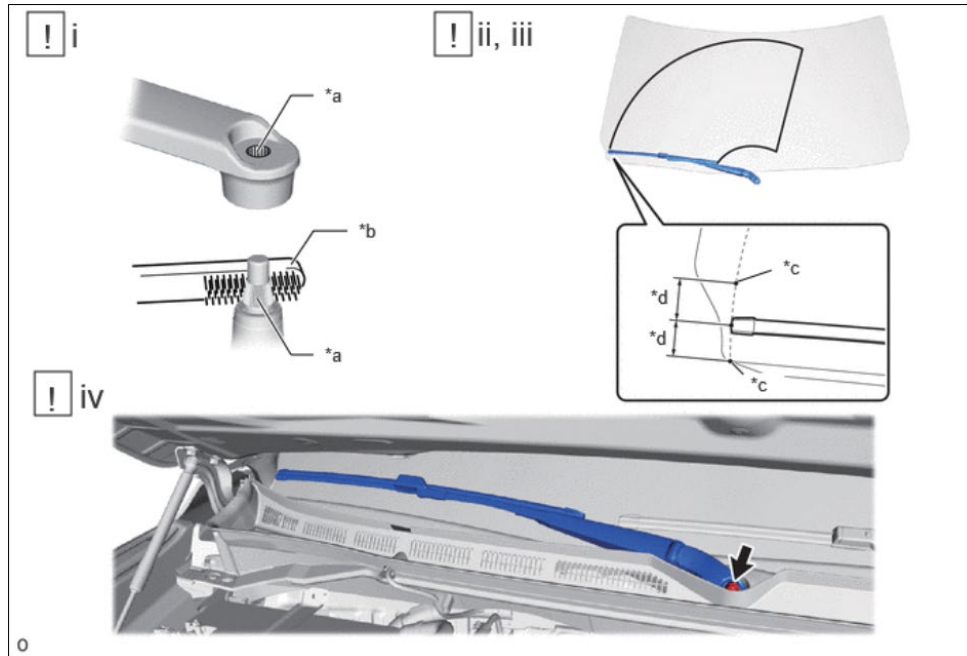

*a	Serration	*b	Wire Brush
*c	Ceramic Dot	*d	7.5 mm (0.295 in.)

- a. Clean the wiper arm serrations to remove any burrs, dirt, etc.
NOTE: Do not grind down the wiper arm serrations.
- b. Set the automatic stop position by the below procedure.
 - i. Turn the ignition switch to ON.
 - ii. Operate the windshield wipers while spraying washer fluid onto the windshield glass. Make sure that the windshield wipers function properly and the wipers do not contact the vehicle body.
 - iii. Turn the ignition switch off.
- c. Temporarily install the front wiper arm and blade assembly RH with the nut to the position shown in the illustration.
- d. Install the front wiper arm and blade assembly RH with the nut to the position shown in the illustration.

Torque: 27 N·m {275 kgf·cm, 20 ft·lbf}

NOTE: Hold the arm hinge by hand when tightening the nut.

39. INSTALL FRONT WIPER ARM AND BLADE ASSEMBLY LH

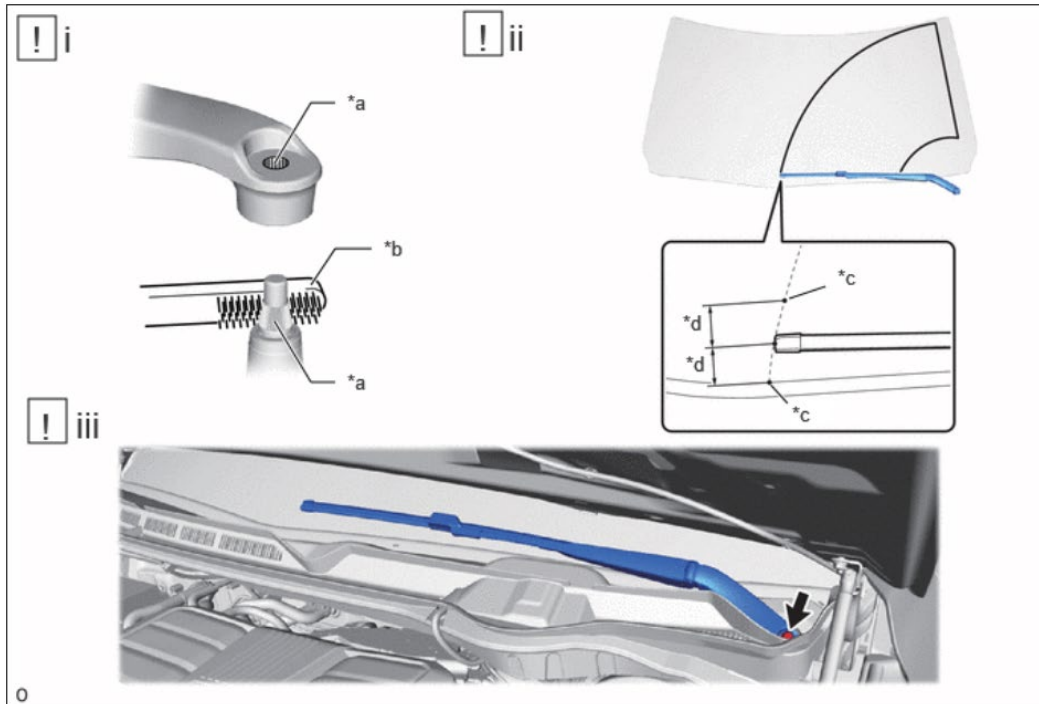

*a	Serration	*b	Wire Brush
*c	Ceramic Dot	*d	7.5 mm (0.295 in.)

- e. Clean the wiper arm serrations to remove any burrs, dirt, etc.

NOTE: Do not grind down the wiper arm serrations.

- f. Set the automatic stop position by the below procedure.
- Turn the ignition switch to ON.
 - Operate the windshield wipers while spraying washer fluid onto the windshield glass. Make sure that the windshield wipers function properly and the wipers do not contact the vehicle body.
 - Turn the ignition switch off.
- g. Temporarily install the front wiper arm and blade assembly LH with the nut to the position shown in the illustration.
- h. Install the front wiper arm and blade assembly LH with the nut to the position shown in the illustration.

Torque: 27 N·m {275 kgf·cm, 20 ft·lbf}

NOTE: Hold the arm hinge by hand when tightening the nut.

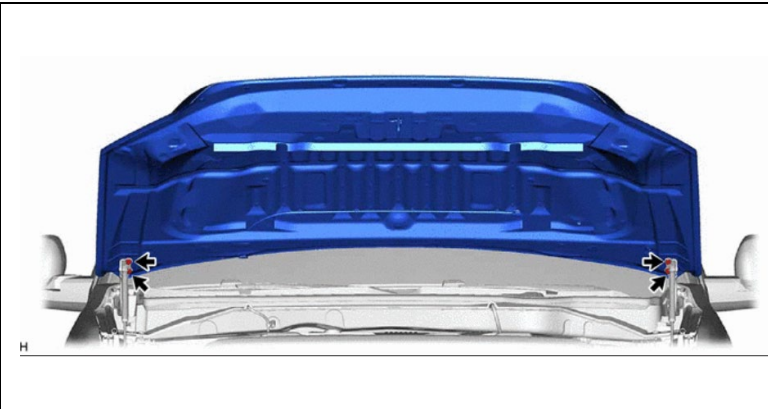

40. INSTALL HOOD SUB-ASSEMBLY

NOTE: Be sure to perform this procedure with several people as the hood sub-assembly is very heavy.

Torque: 22.4 N·m {228 kgf·cm, 17 ft·lbf}

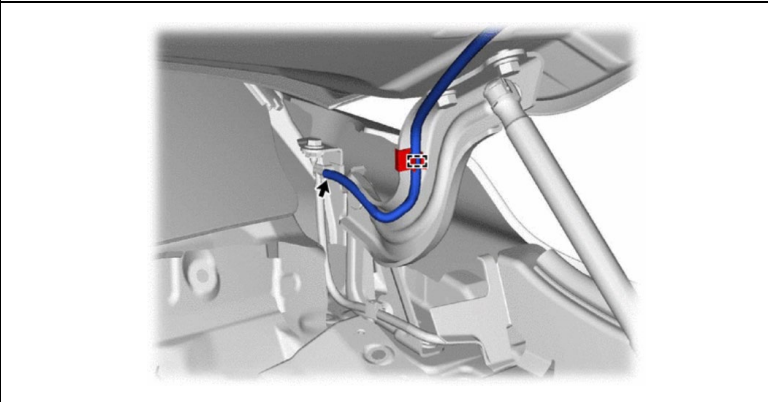

41. CONNECT WINDSHIELD WASHER HOSE ASSEMBLY

42. INSTALL FAN SHROUD

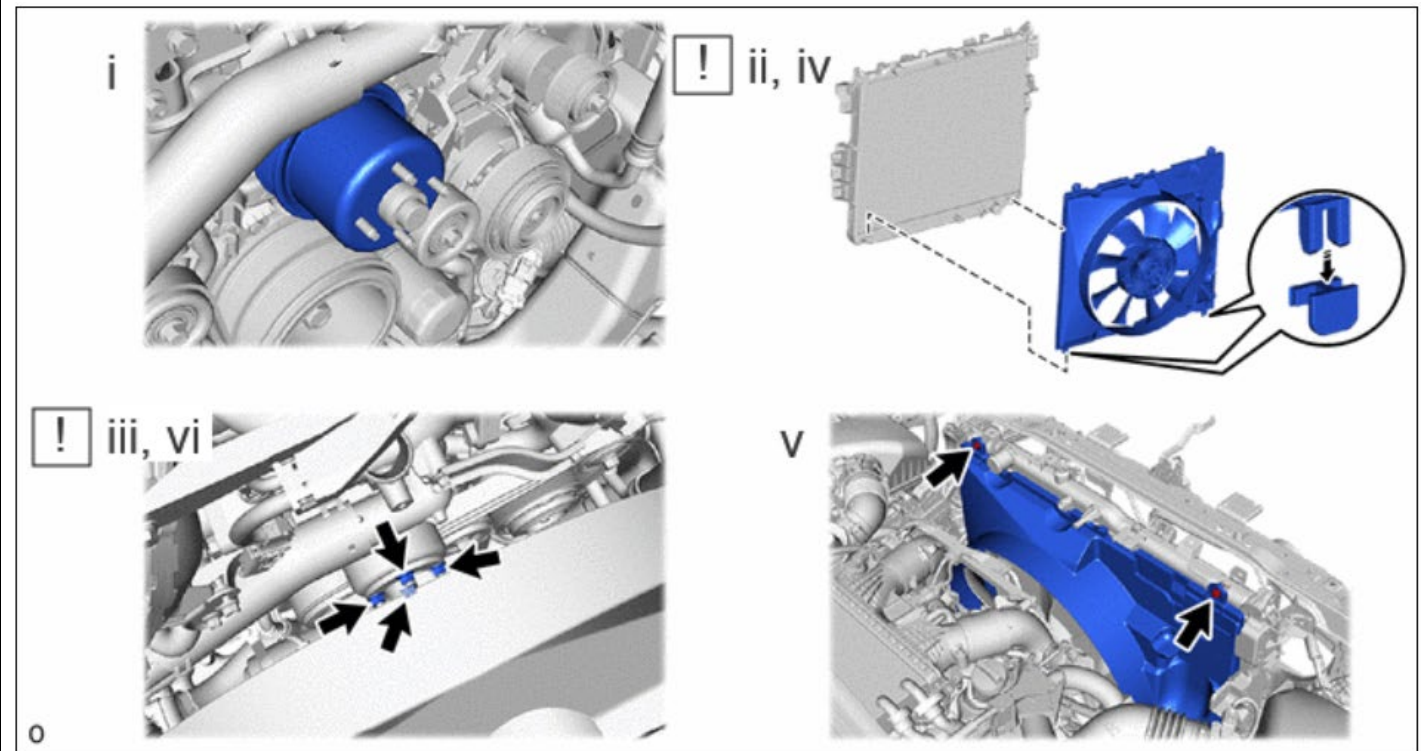

- a. Install the fan pulley to the engine water pump assembly.
- b. Place the fan shroud together with the fluid coupling assembly with fan between the radiator and engine.

NOTE: Be careful not to damage the radiator core.

- c. Temporarily install the fluid coupling assembly with fan to the engine water pump assembly with the 4 nuts. Tighten the nuts as much as possible by hand.
- d. Attach the claws of the fan shroud to the radiator as shown in the illustration.
- e. Install the fan shroud with the 2 bolts.

Torque: 6.5 N·m {66 kgf·cm, 58 in·lbf}

- f. Tighten the 4 nuts of the fluid coupling assembly with fan.

Torque: 21 N·m {214 kgf·cm, 15 ft·lbf}

43. INSTALL FAN AND GENERATOR V BELT

NOTE: When re-using the fan and generator V belt, check the entire circumference of the belt for wear and cracks on the ribs and rear side. Replace belts where wear and cracks have advanced to the wire core and belts with missing rib rubber.

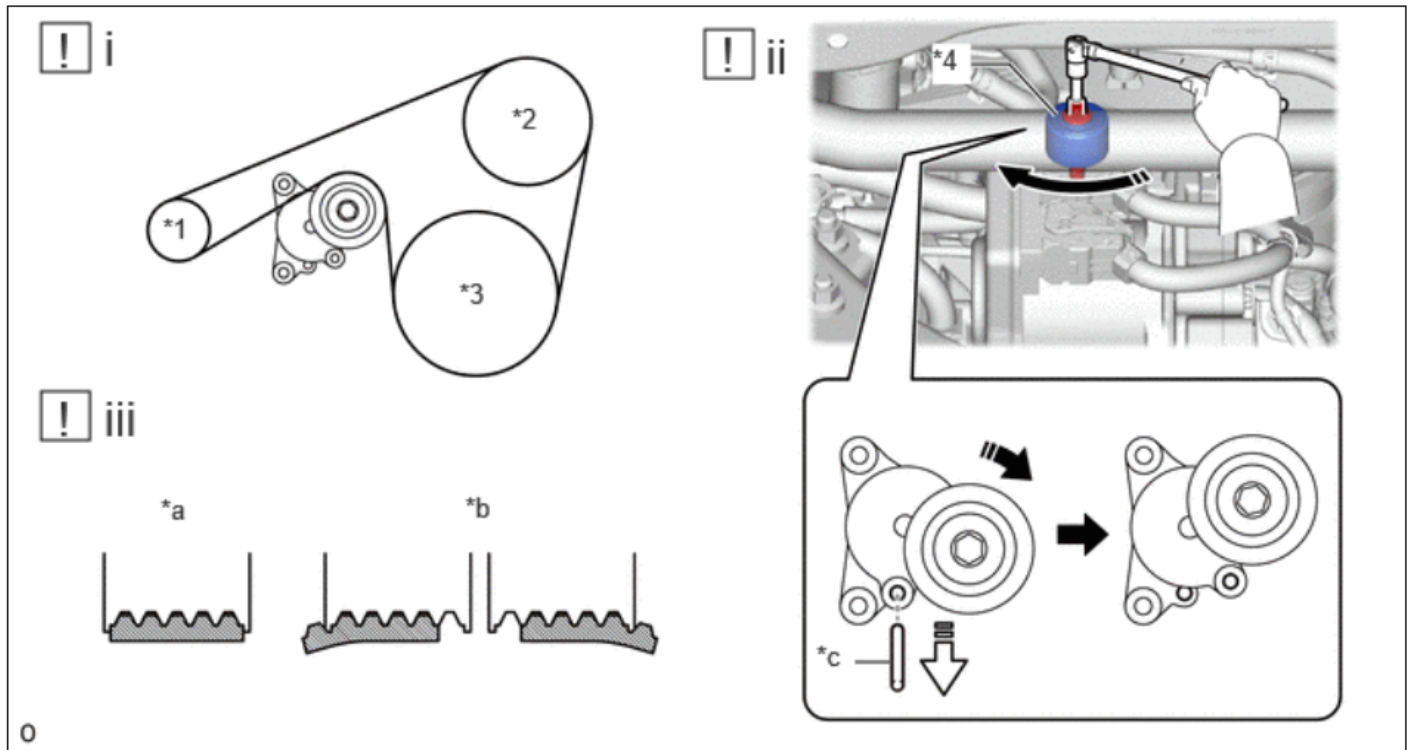

*1	Generator Assembly	*2	Water Pump Assembly
*3	Crankshaft Pulley	*4	V-ribbed Belt Tensioner Assembly
*a	Correct	*b	Incorrect
*c	5 mm Hexagon Wrench	-	-
	Turn in this Direction		Remove the 5 mm hexagon wrench

- a. Set the fan and generator V belt onto each part.

- b. Rotate the V-ribbed belt tensioner assembly clockwise, and then remove the 5 mm hexagon wrench.

NOTE: Make sure that the fan and generator V belt is properly installed to each pulley.

- c. Check that the belt fits properly in the ribbed grooves.

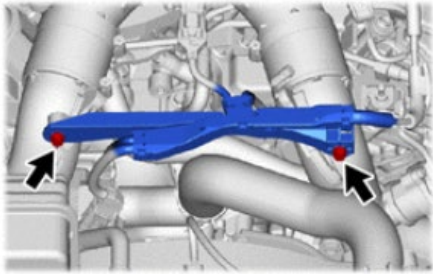



44. CONNECT ENGINE WIRE

Torque: 10 N·m {102 kgf·cm, 7 ft·lbf}

45. INSTALL NO. 1 V BELT (COOLER COMPRESSOR TO CRANKSHAFT PULLEY)

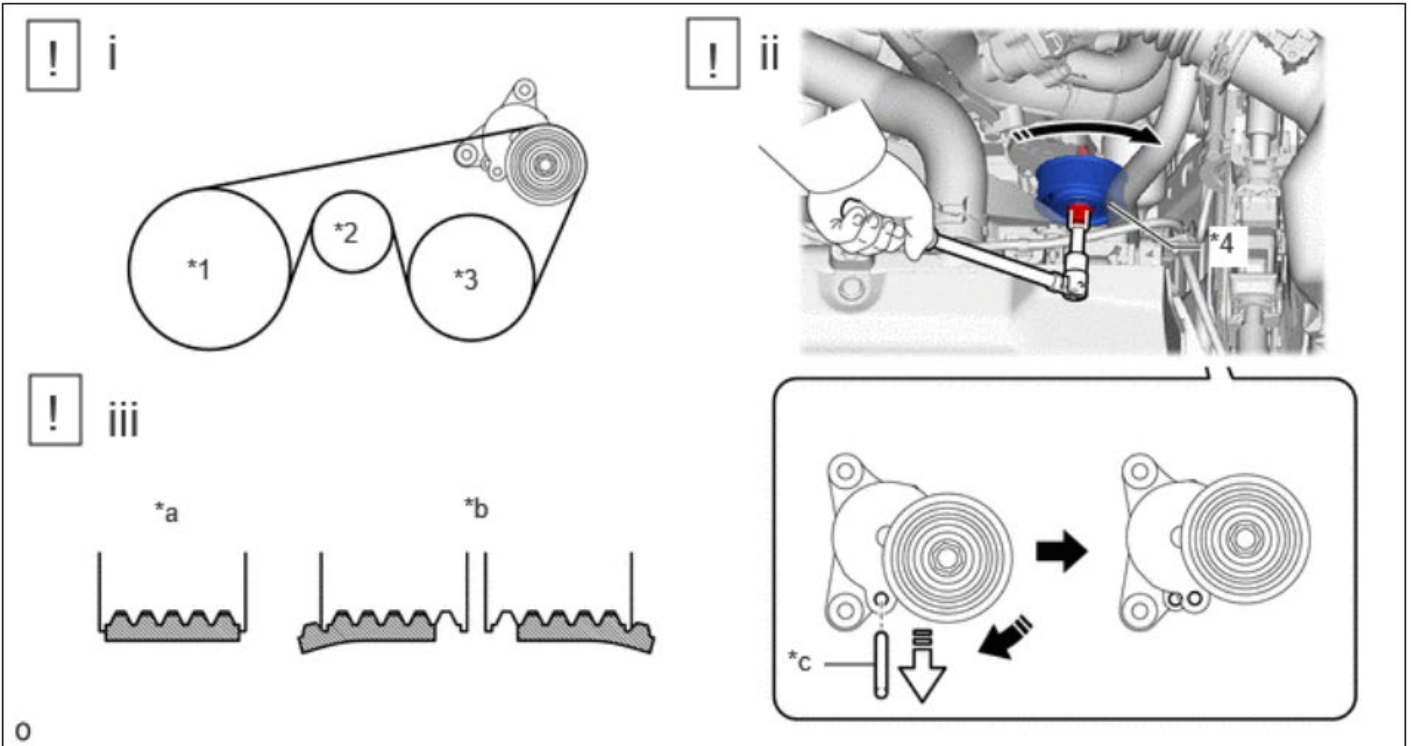
NOTE: When re-using the No. 1 V belt (cooler compressor to crankshaft pulley), check the entire circumference of the belt for wear and cracks on the ribs and rear side. Replace belts where wear and cracks have advanced to the wire core and belts with missing rib rubber.



*1	Crankshaft Pulley	*2	No. 2 Idler Pulley Sub-assembly
*3	Compressor Assembly with Pulley	*4	V-ribbed Belt Tensioner Assembly
*a	Correct	*b	Incorrect
*c	5 mm Hexagon Wrench	-	-
	Turn in this Direction		Remove the 5 mm hexagon wrench



- a. Set the No. 1 V belt (cooler compressor to crankshaft pulley) onto each part.
- b. Rotate the V-ribbed belt tensioner assembly clockwise, and then remove the 5 mm hexagon wrench.

NOTE: Make sure that the No. 1 V belt (cooler compressor to crankshaft pulley) is properly installed to each pulley.

- c. Check that the belt fits properly in the ribbed grooves.

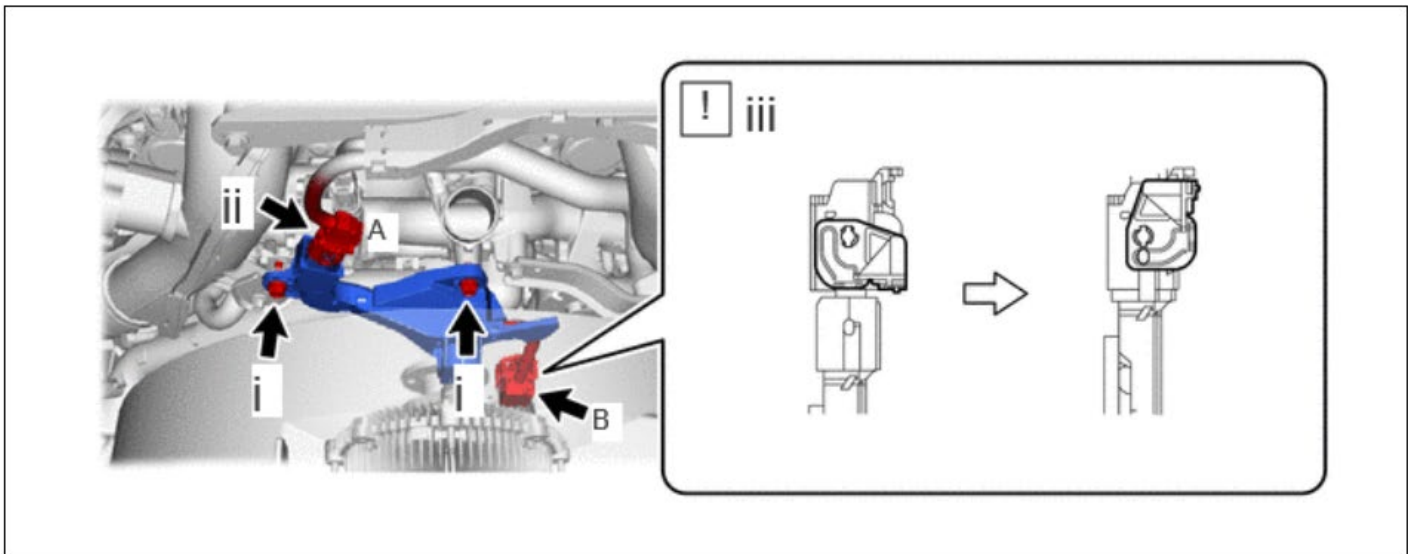
46. INSTALL COOLING FAN WIRE



*1	Crankshaft Pulley	*2	No. 2 Idler Pulley Sub-assembly
*3	Compressor Assembly with Pulley	*4	V-ribbed Belt Tensioner Assembly
*a	Correct	*b	Incorrect
*c	5 mm Hexagon Wrench	-	-
	Turn in this Direction		Remove the 5 mm hexagon wrench

- a. Install the cooling fan wire with the 2 bolts.

Torque: 10 N·m {102 kgf·cm, 7 ft·lbf}

- b. Connect the connector A.
- c. Connect connector B and lock it with the lever.

NOTE: When connecting the connectors, make sure that dirt, water or other foreign matter does not become stuck between the connectors and other parts. Make sure that the lever are securely locked.

47. CONNECT OIL COOLER TUBE SUB-ASSEMBLY

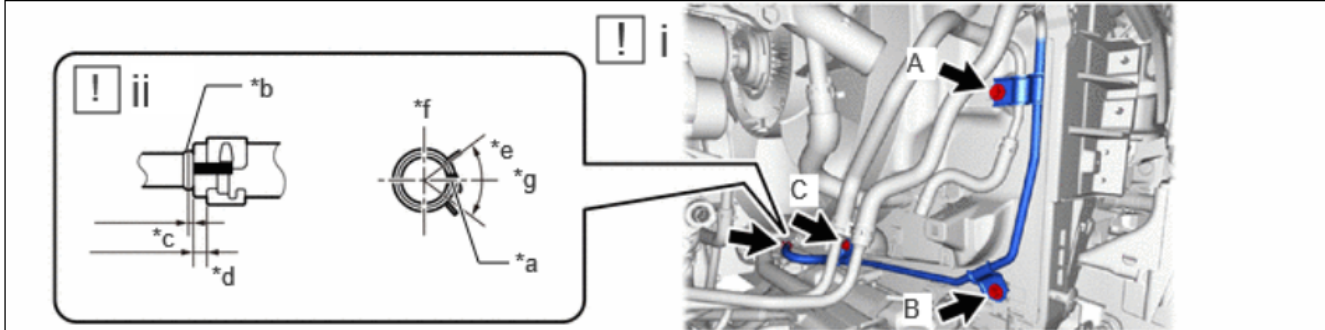

*a	Paint Mark	*b	Stopper
*c	0 to 3.0 mm (0 to 0.118 in.)	*d	2.0 to 7.0 mm (0.0787 to 0.276 in.)
*e	90°	*f	Upper Side
*g	Rear Side	-	-

- g. Connect the oil cooler tube sub-assembly to the fan shroud with the 3 bolts.

Torque: 5.5 N·m {56 kgf·cm, 49 in·lbf}

NOTE: Tightening order: Temporarily install bolt A → Tighten bolt B → Tighten bolt C → Tighten bolt A

- h. Connect the oil cooler tube sub-assembly to the radiator assembly and slide the hose clip to secure it as shown in the illustration.

NOTE: Make sure the oil cooler tube sub-assembly is securely inserted to the stopper.

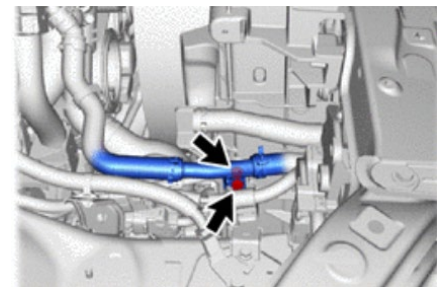

48. CONNECT NO. 2 WATER BY-PASS PIPE

Torque: 5.0 N·m {51 kgf·cm, 44 in·lbf}

49. CONNECT NO. 2 RADIATOR HOSE

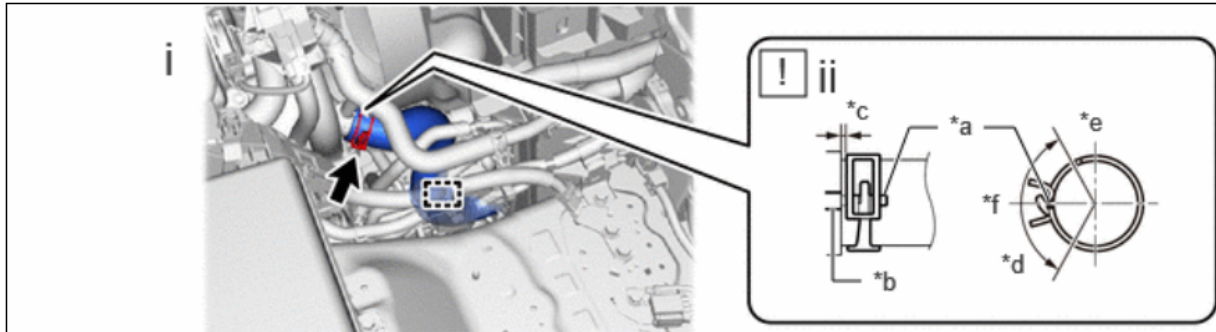

*a	Paint Mark	*b	Stopper
*c	2.0 to 7.0 mm (0.0787 to 0.276 in.)	*d	120°
*e	Upper Side	*f	RH Side

- i. Attach the clamp.
- j. Connect the No. 2 radiator hose to the water inlet pipe and slide the hose clip to secure it as shown in the illustration.

NOTE: Install so that the paint mark and positioning stopper are securely overlapped.

NOTE: Make sure the No. 2 radiator hose is securely inserted to the stopper.

50. CONNECT NO. 1 RADIATOR HOSE

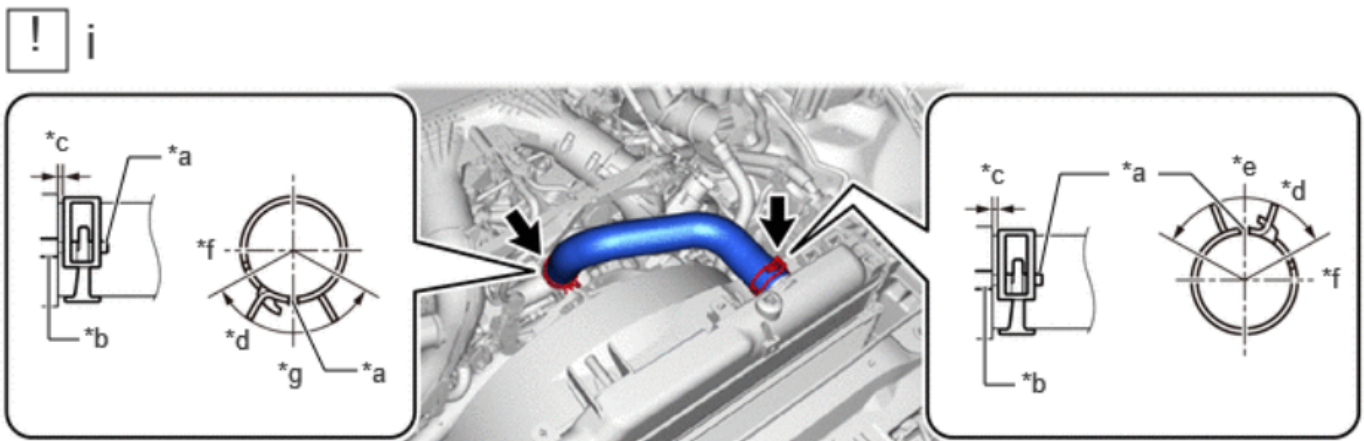

*a	Paint Mark	*b	Stopper
*c	2.0 to 5.0 mm (0.0787 to 0.197 in.)	*d	120°
*e	Upper Side	*f	RH Side
*g	Front Side	-	-

- k. Install the No. 1 radiator hose to the water outlet pipe and radiator assembly and slide the 2 hose clips to secure it as shown in the illustration.

NOTE: Install so that the paint mark and positioning stopper are securely overlapped.

NOTE: Make sure the No. 1 radiator hose is securely inserted to the stopper.

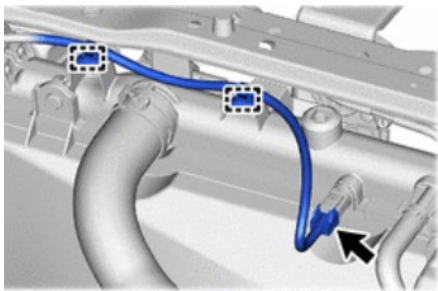



51. CONNECT ENGINE COOLANT TEMPERATURE SENSOR

- a. Connect the engine coolant temperature sensor connector.
- b. Attach the 2 clamps.

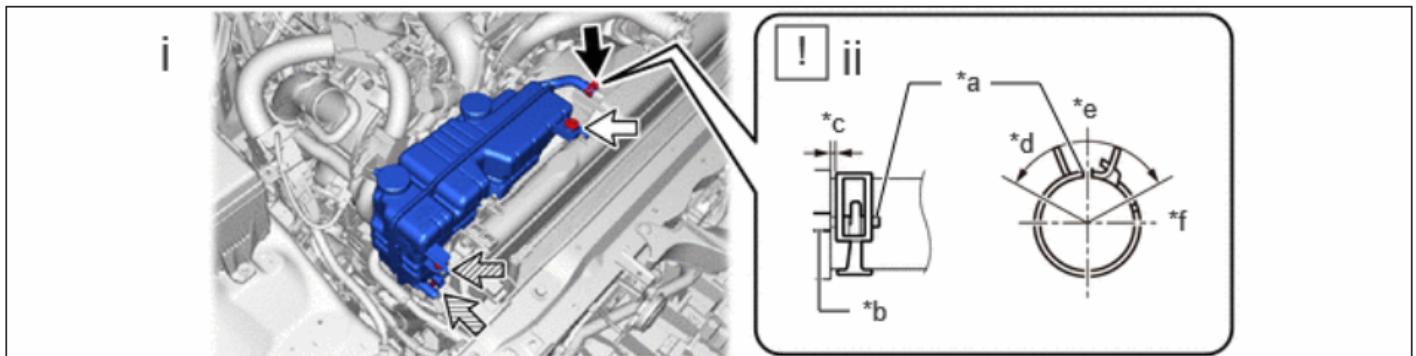
52. INSTALL RADIATOR RESERVE TANK ASSEMBLY



*a	Paint Mark	*b	Stopper
*c	2.0 to 5.0 mm (0.0787 to 0.197 in.)	*d	120°
*e	Upper Side	*f	RH Side
	Bolt A		Bolt B

- a. Install the radiator reserve tank assembly to the radiator assembly with the 3 bolts.

Torque: 6.5 N·m {66 kgf·cm, 58 in·lbf}

- b. Connect the radiator reserve tank hose to the radiator assembly and slide the hose clip to secure it as shown in the illustration.

NOTE: Install so that the paint mark and positioning stopper are securely overlapped.

NOTE: Make sure the radiator reserve tank hose is securely inserted to the stopper.

53. CONNECT NO. 2 WATER BY-PASS HOSE

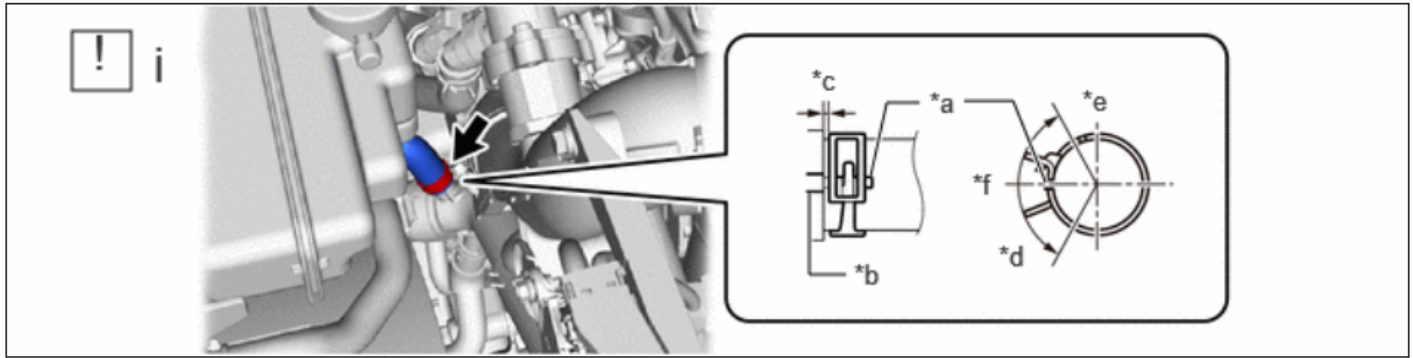

*a	Paint Mark	*b	Stopper
*c	2.0 to 7.0 mm (0.0787 to 0.276 in.)	*d	120°
*e	Rear Side	*f	RH Side

- a. Connect the No. 2 water by-pass hose to the water inlet pipe and slide the hose clip to secure it as shown in the illustration.

NOTE: Install so that the paint mark and positioning stopper are securely overlapped.

NOTE: Make sure the No. 2 water by-pass hose is securely inserted to the stopper.

54. CONNECT NO. 3 WATER BY-PASS HOSE

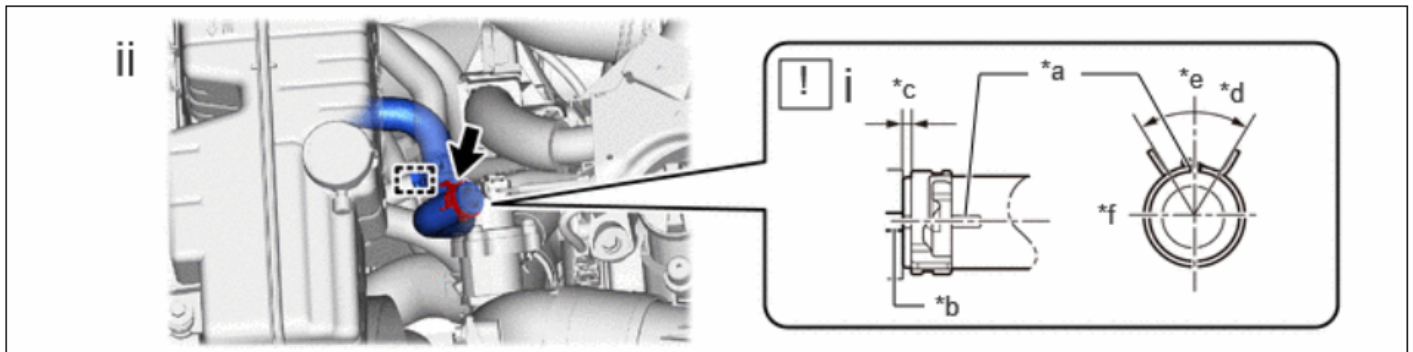

*a	Paint Mark	*b	Stopper
*c	2.0 to 5.0 mm (0.0787 to 0.197 in.)	*d	60°
*e	Upper Side	*f	RH Side

- a. Connect the No. 3 water by-pass hose to the radiator reserve tank assembly and slide the hose clip to secure it as shown in the illustration.

NOTE: Install so that the paint mark and positioning stopper are securely overlapped.

NOTE: Make sure the No. 3 water by-pass hose is securely inserted to the stopper.

- b. Attach the clamp

55. CONNECT WATER BY-PASS HOSE

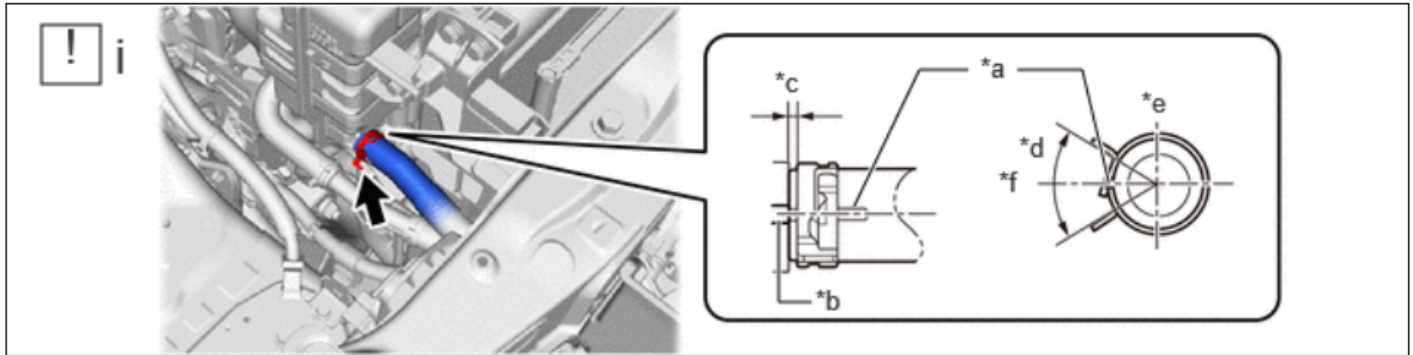

*a	Paint Mark	*b	Stopper
*c	2.0 to 5.0 mm (0.0787 to 0.197 in.)	*d	60°
*e	Upper Side	*f	RH Side

- a. Connect the water by-pass hose to the radiator reserve tank assembly and slide the hose clip to secure it as shown in the illustration.

NOTE: Install so that the paint mark and positioning stopper are securely overlapped.

NOTE: Make sure the No. 3 water by-pass hose is securely inserted to the stopper.

56. INSTALL AIR CLEANER ASSEMBLY LH WITH AIR CLEANER HOSE ASSEMBLY LH

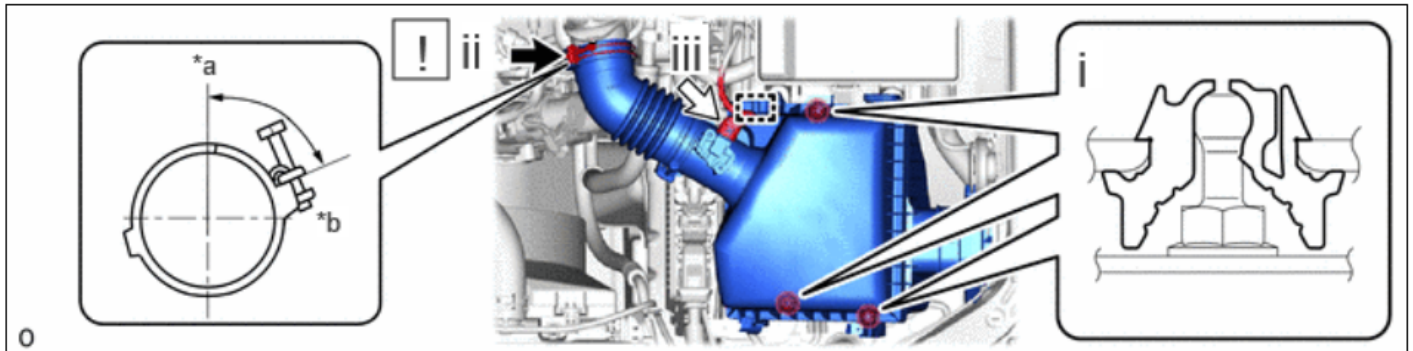

*a	Upper Side	*b	RH Side
----	------------	----	---------

- a. Attach the 3 grommets to install the air cleaner assembly LH with air cleaner hose assembly LH.
 b. Tighten the hose clamp in the position shown in the illustration.

Torque: 2.8 N·m {29 kgf·cm, 25 in·lbf}

NOTE: Make sure that the clamp bolt of the hose clamp are within the area shown in the illustration.

- c. Attach the clamp and connect the connector.

57. INSTALL AIR CLEANER ASSEMBLY RH WITH AIR CLEANER HOSE ASSEMBLY RH

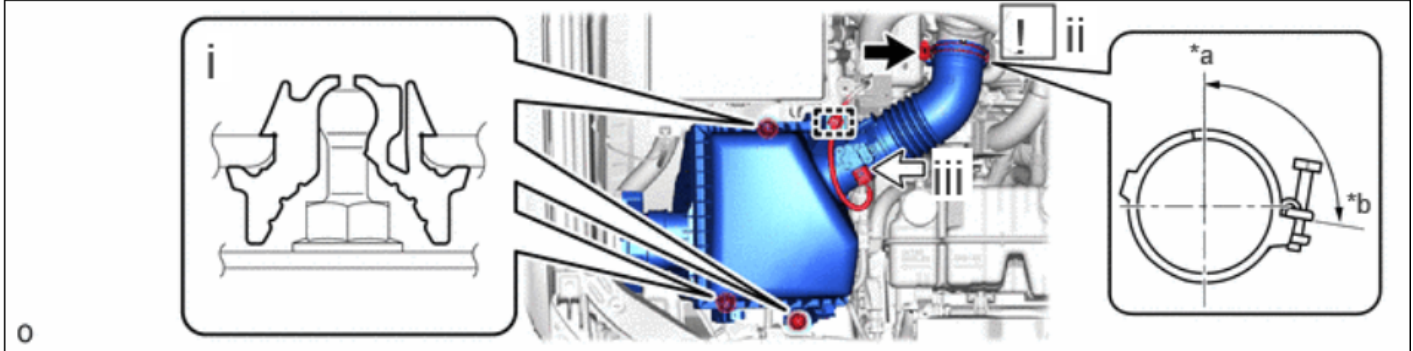

*a	Upper Side	*b	RH Side
----	------------	----	---------

- a. Attach the 3 grommets to install the air cleaner assembly RH with air cleaner hose assembly RH.
- b. Tighten the hose clamp in the position shown in the illustration.

Torque: 2.8 N·m {29 kgf·cm, 25 in·lbf}

NOTE: Make sure that the clamp bolt of the hose clamp are within the area shown in the illustration.

- c. Attach the clamp and connect the connector.

58. CONNECT NO. 4 WATER BY-PASS PIPE

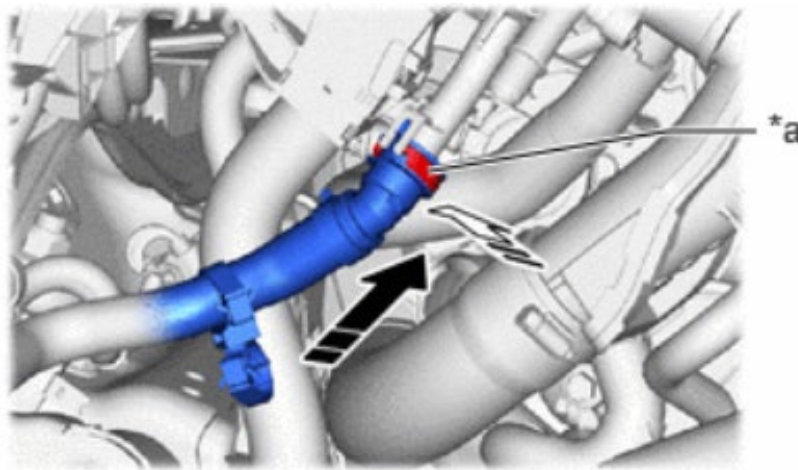

*a	Retainer	-	-
	Push		Push in

NOTE: Check that there is no damage or foreign matter on the connecting parts of the water lines.

- a. Align the protrusion of the water by-pass pipe assembly with the cutout in the No. 4 water by-pass hose assembly connector and securely insert the No. 4 water by-pass hose assembly connector to the stopper of the pipe.
- b. Push in the retainer.

- c. Check that the water by-pass pipe assembly and No. 4 water by-pass hose assembly connector are securely connected by pulling on them.

59. INSTALL BATTERY

- e. Install battery
- f. Install battery clamp sub assembly

Torque: 18.5 N·m {189 kgf·cm, 14 ft·lbf}

- g. Install No. 2 Battery Carrier Bracket

Torque: 7.6 N·m {77 kgf·cm, 67 in·lbf}

- h. Connect cable to positive battery terminal

Torque: 4.8 N·m {49 kgf·cm, 42 in·lbf}

- i. Connect cable to negative battery terminal

Torque: 5.4 N·m {55 kgf·cm, 48 in·lbf}

60. INSTALL V-BANK COVER SUB-ASSEMBLY

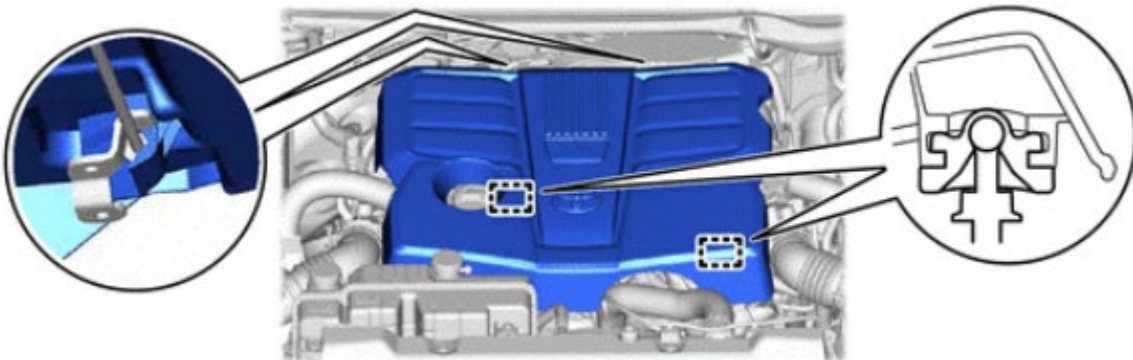

61. INSTALL NO. 2 RADIATOR AIR GUIDE

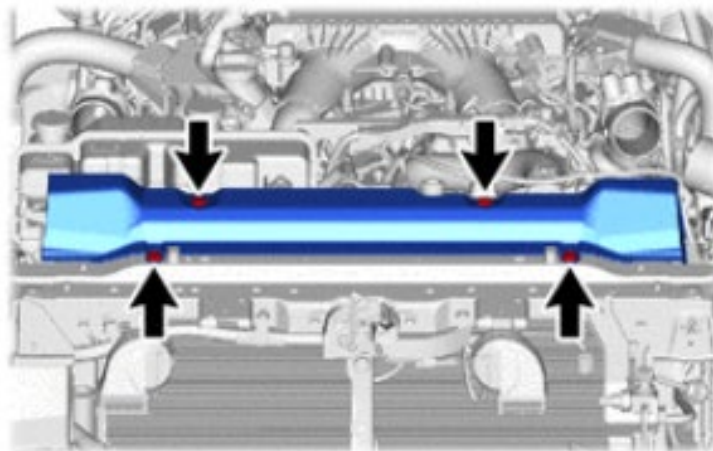

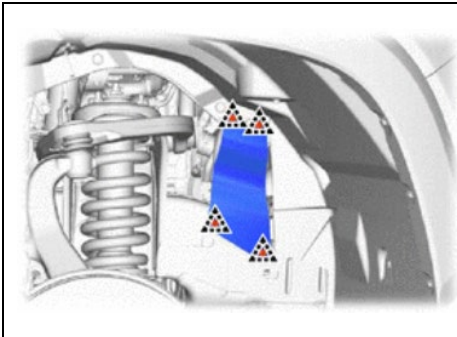

62. INSTALL FRONT FENDER APRON TRIM PACKING A

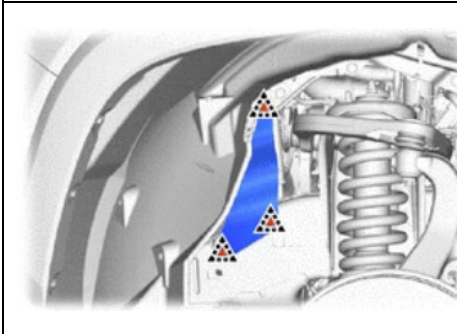

63. INSTALL FRONT FENDER APRON TRIM PACKING B

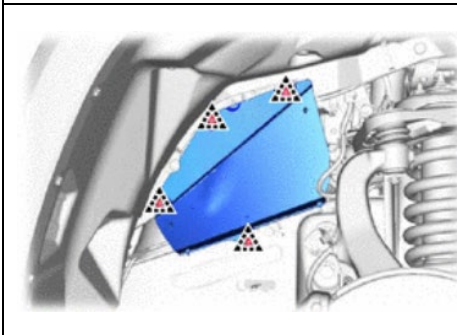

64. INSTALL FRONT FENDER APRON TRIM PACKING C

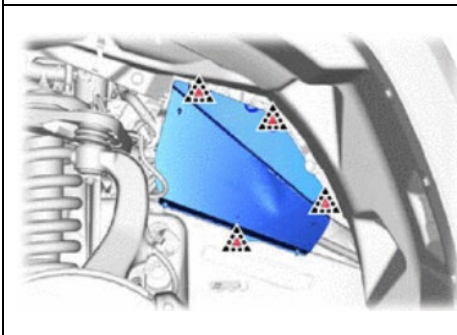

65. INSTALL FRONT FENDER APRON TRIM PACKING D

66. INSTALL FRONT WHEELS

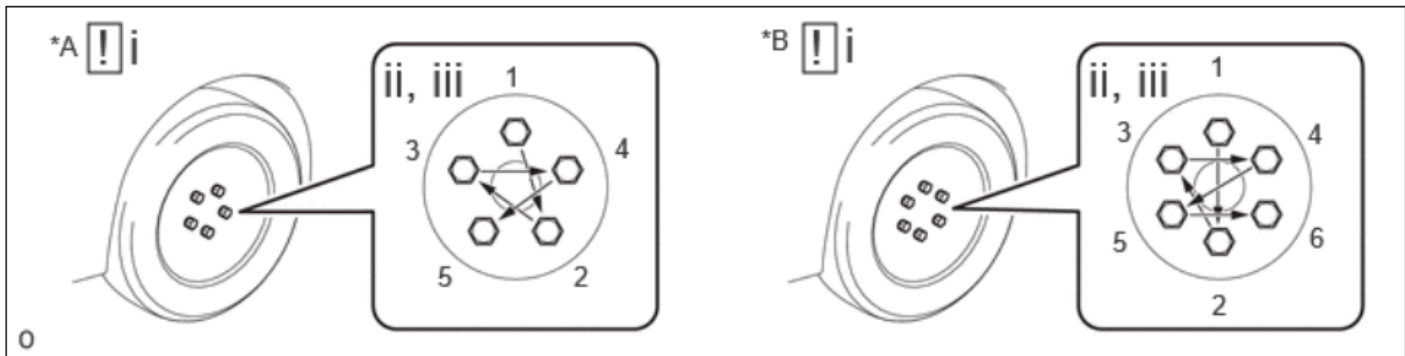

*A for 5 Bolt Axle Hub

*B for 6 Bolt Axle Hub

- While aligning the wheel assembly with the center of the axle hub, install the axle hub nuts by hand.
- Temporarily tighten the axle hub nuts in the order shown in the illustration.
- Lower the vehicle then fully tighten the axle hub nuts in the order shown in the illustration.

Torque:

Steel Wheel : 209 N·m {2131 kgf·cm, 154 ft·lbf}

Aluminum Wheel : 131 N·m {1336 kgf·cm, 97 ft·lbf}

67. CHARGE AIR CONDITIONING SYSTEM WITH REFRIGERANT (RM100000002281Z)

NOTE: Charge refrigerant in accordance with the equipment manual.

- Perform vacuum purging using a vacuum pump or appropriate equipment.

NOTE: Be sure to use a refrigerant recovery unit that is compatible with HFO-1234yf (R1234yf) systems.

- Charge the air conditioning system with refrigerant.

Refrigerant Type: HFO-1234yf (R1234yf)

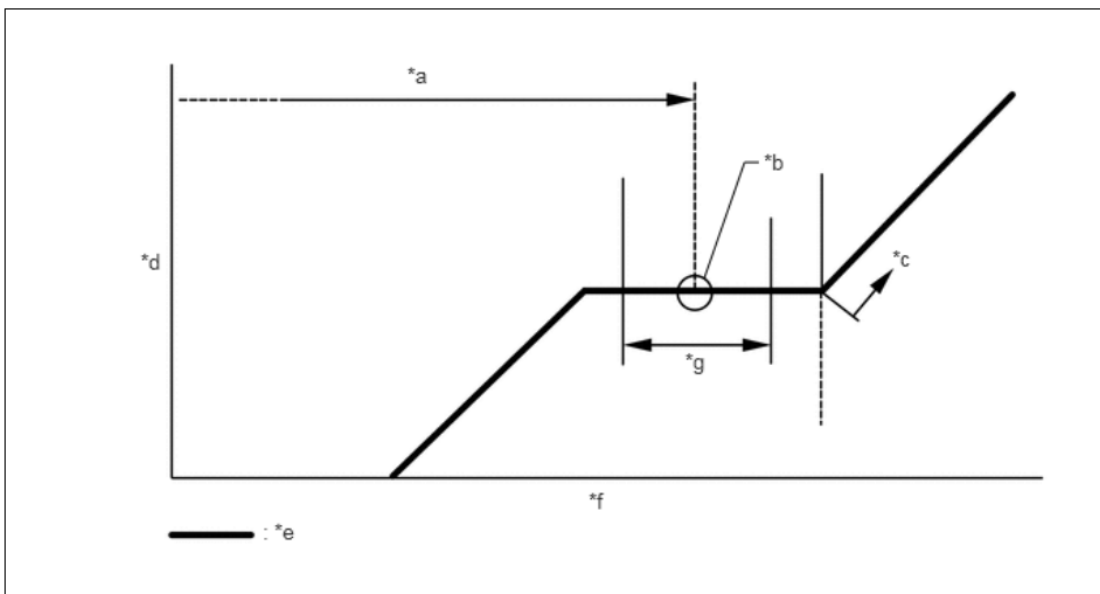

*a	Standard Charge Amount	*b	Mean Value in Proper Range
*c	Overcharged	*d	High Pressure
*e	Sub-cool System	*f	Refrigerant Amount
*g	+/-30 g (+/-1.05 oz)	-	-

Standard charge amount: Gasoline Model: 620 to 680 g (21.9 to 23.9 oz)

NOTE: Do not turn the A/C switch on before charging the air conditioning system with refrigerant. Doing so may cause the compressor to work without refrigerant, resulting in overheating of the

compressor. The refrigerant amount should be checked by quantity (weight). The graph above is shown for reference only.

NOTE: Ensure that sufficient refrigerant is available to recharge the system when using a refrigerant recovery unit. Refrigerant recovery units are not always able to recover 100% of the refrigerant from an air conditioning system.

68.ADD COOLANT (FOR ENGINE) RM100000001Z8XJ

NOTE:

- Do not remove the reserve tank cap or drain cock plug while the engine and radiator assembly are still hot. Pressurized, hot engine coolant and steam may be released and cause serious burns.
 - To prevent injury due to contact with an operating fan and generator V belt or cooling fan, keep your hands and clothing away from the fan and generator V belt and cooling fans when working in the engine compartment with the engine running.
 - Do not substitute plain water for engine coolant.
 - Before adding coolant, turn the A/C switch off.
- a. Remove the reserve tank cap.
 - b. Remove the radiator drain cock and remove the O-ring from the radiator drain cock.
 - c. Inject the specified concentration of coolant through the radiator side drain cock until the radiator is full.

Specified Capacity: 12.4 liters (13.1 US qts, 10.9 Imp. qts)

- d. Squeeze the No. 1 radiator hose and No. 2 radiator hose several times by hand, and then check the level of the engine coolant.
 - i. If the engine coolant level is low, add engine coolant.
- e. Install a **NEW** O-ring to the radiator drain cock and install the radiator drain cock.
- f. Install the reserve tank cap.

Torque: 2.0 N·m {20 kgf·cm, 18 in·lbf}

NOTE: Keep the O-ring and O-ring fitting surface free of foreign matter.

- g. Bleed air from the cooling system.
 - ii. Warm up the engine until the water inlet with thermostat sub-assembly opens. While the water inlet with thermostat sub-assembly is open, circulate the engine coolant for several minutes.

NOTE:

- Make sure that the radiator reserve tank assembly still has some engine coolant in it.
- If the engine coolant temperature gauge indicates an excessive temperature, turn off the engine and let it cool.
- If there is not enough engine coolant, the engine may overheat or be seriously damaged.
- If the radiator reserve tank assembly does not have enough engine coolant, perform the following: 1) stop the engine, 2) wait until the engine coolant cools down, and 3) add engine coolant until the radiator reserve tank assembly is filled to the full line.

- iii. Maintain the engine speed at 2500 to 3000 rpm.

- iv. Squeeze the No. 1 radiator hose and No. 2 radiator hose several times by hand to bleed air.

NOTE:

- Because the engine, radiator assembly, No. 1 radiator hose and No. 2 radiator hose are extremely hot, do not perform these procedures without wearing protective gloves.
- Performing these procedures without wearing protective gloves could result in burns.
- Touching rotating components such as the cooling fan could result in your hand or clothing getting caught and pulled in.

- h. Stop the engine, and wait until the engine coolant cools down.
- i. After the engine coolant cools down, check that the coolant level is at the F line. If the coolant level is below the F line, add engine coolant to the F line.
- j. Inspect for coolant leaks.

69. ADD COOLANT (FOR INTERCOOLER) RM100000001ZOIT

NOTE:

- Do not remove the reserve tank cap (for Intercooler) while the coolant (for Intercooler) is still hot. Pressurized, hot coolant and steam may be released and cause serious burns.

- k. When using the GTS:
- v. Remove the reserve tank cap (for Intercooler).
- vi. Add engine coolant to the intercooler reserve tank filler opening until it is filled to the F line at shown in the illustration.

Standard capacity: 4.4 liters (4.6 US qts, 3.9 Imp. qts)

NOTE: Never use water as a substitute for coolant.

- vii. While adding coolant so that the coolant level is kept near the F line in the intercooler reserve tank, activate the electric water pump assembly for approximately 1 minute and then stop pump operation for 1 minute. At that time, check that air bubbles are discharged to the intercooler reserve tank.

Powertrain > Engine > Active Test

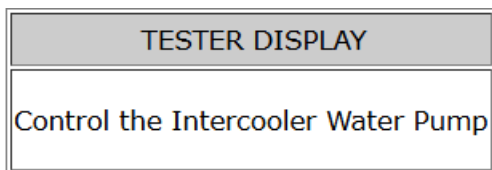

Standard: Repeat this operation approximately 3 times until the sound of the electric water pump assembly gets smaller and no more bubbles are visible from the intercooler reserve tank or the coolant level in the intercooler reserve tank stabilizes. When this condition is reached, this indicates that air is completely bled from the coolant system.

NOTE: If the intercooler reserve tank is filled excessively with coolant, coolant may spill out when the electric water pump assembly is stopped.

- viii. When air is completely bled, add coolant up to the F line in the intercooler reserve tank, and install the reserve tank cap (for Intercooler).
- ix. Install the reserve tank cap (For Intercooler)
- x. Start the engine
- xi. In order to operate the electric water pump assembly, maintain the engine speed at 2000 rpm or higher with the shift lever in N or P for 1 minute and then stop operation for 1 minute. Repeat this operation approximately 2 times until the sound of the electric water pump assembly gets smaller and no more bubbles are visible from the intercooler reserve tank or the coolant level in the intercooler reserve tank stabilizes

NOTE:

- Performing these procedures without wearing protective gloves could result in burns.
- Be careful as the radiator hoses are hot.
- Keep your hands away from the cooling fan.
- Make sure that the coolant level in the intercooler reserve tank does not drop below the L line when the engine speed is 2000 rpm or higher.
- Immediately after starting the engine, if the intercooler reserve tank runs out of coolant, perform the following: 1) stop the engine, 2) wait until the coolant has cooled down, and 3) pour in coolant until it reaches the F line.

- xii. Stop the engine and wait until the coolant cools down to ambient temperature.
- xiii. Check that the coolant level is between the F and L lines.
 1. If the coolant level is lower than the L line, pour coolant of the specified concentration into the intercooler reserve tank until it reaches the F line, and repeat the procedure from steps
 2. If the coolant level is above the F line, drain coolant so that the coolant level is between the F and L lines.
- l. Inspect for coolant (for intercooler) leaks.

70. CHECK ENGINE OIL LEVEL RM100000022SUQ

- a. Warm up and stop the engine, and then wait for 5 minutes. The oil level should be between the dipstick's low level mark and full level mark. The **NEW** engine comes filled with oil but if necessary, you may add oil.

NOTE: Do not add engine oil to above the full level mark.

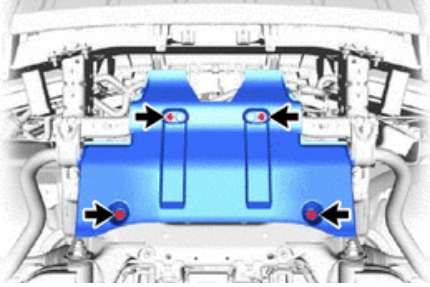
	<p>71. INSTALL NO. 1 ENGINE UNDER COVER ASSEMBLY a. w/ Front Active Spoiler System: Set the front active spoiler to the service deploy position.</p> <p>CAUTION: Make sure that your hands, etc. do not get caught while the front active spoiler is operating.</p> <ol style="list-style-type: none"> 1. Turn the ignition switch off. 2. Set the windshield wiper switch assembly to "mist" and hold it for 2 seconds. <p>NOTICE: Operate within 45 seconds after turning the ignition switch to off</p> <ol style="list-style-type: none"> 3. Make sure that the spoiler is forcibly deployed. <p>HINT: It will retract with the ignition switch ON and the shift lever in D or R</p> <ol style="list-style-type: none"> (2) Install the No. 1 engine under cover with the 4 bolts. <p>Torque: 22 N·m {224 kgf·cm, 16 ft·lbf}</p>
---	---

	<p>Ensure oil dip stick tube is seated correctly after installing engine. If oil dip stick tube is not completely seated, damage may occur to engine. If you have any issues, please email quality_compliance@toyota.com for further assistance.</p>
---	--

a. Restore the vehicle to its original condition.

◀ VERIFY REPAIR QUALITY ▶

- Confirm **NEW** engine assembly is properly installed.
 - Confirm cooling system is properly bled before test drive.
 - Test drive vehicle to ensure engine is installed properly.
 - Confirm that no new DTCs were introduced during the repair.
 - Confirm the original serial number is registered in the website correctly.
 - Confirm the new serial number is registered in the website correctly.
 - Confirm fluids are topped off.
- If you have any questions regarding this update, please contact your regional representative.**

VIII. CRATE USED ENGINE FOR PARTS RECOVER

Following the [job aid](#), crate the used engine for parts return.

IX. APPENDIX

A. CAMPAIGN DESIGNATION DECODER

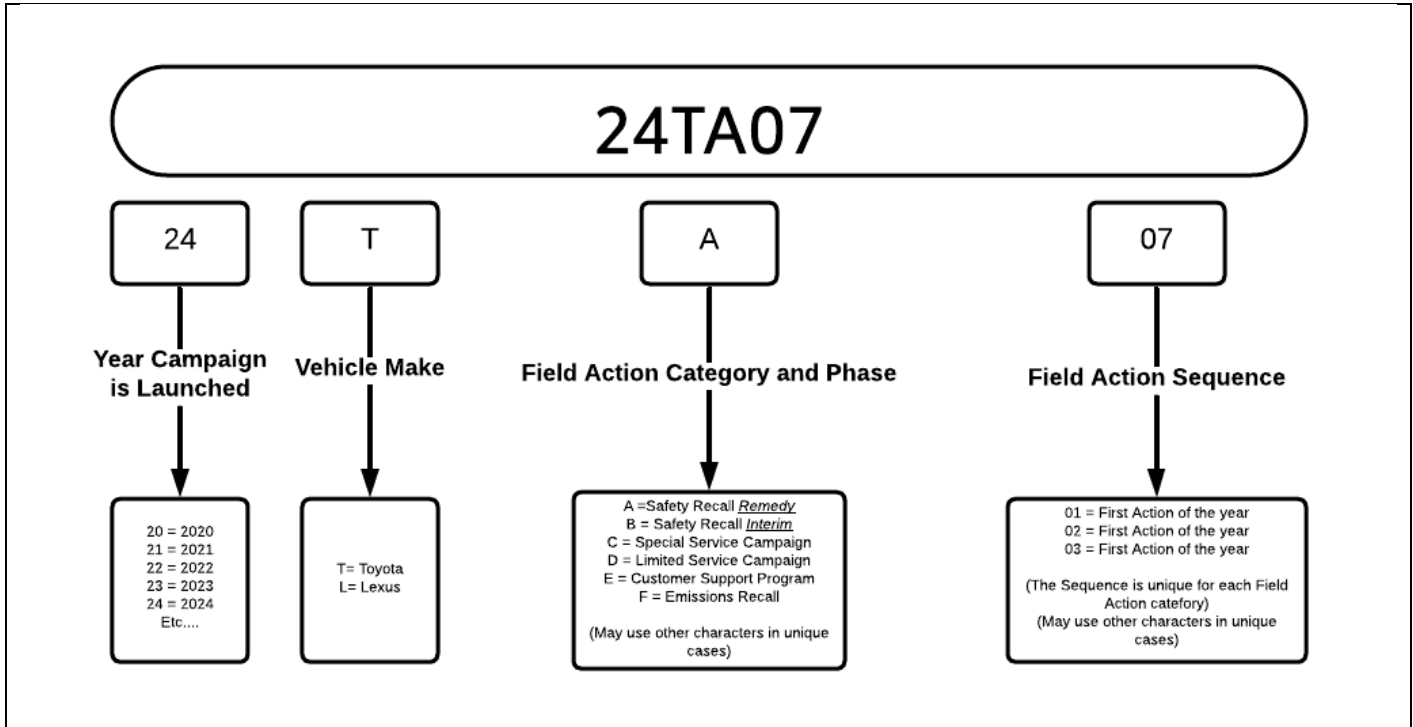

Examples:

19TA01 = Launched in 2019, Toyota, Safety Recall Remedy Phase, 1st Safety Recall Launched in 2019

20TC02 = Launched in 2020, Special Service Campaign, 2nd Special Service Campaign Launched in 2020

21TE05 = Launched in 2021, Customer Support Program, 5th Customer Support Program Launched in 2021