



Service Bulletin

American Honda Motor Co., Inc.

GL1800 #27
February 2024

SAFETY RECALL

2020-2024 GL1800/B/BD/D/DA Fuel Pump Replacement

BACKGROUND

Honda is launching a **SAFETY RECALL** on **CERTAIN** 2020-2024 GL1800/B/BD/D/DA motorcycles to inspect and, if necessary, replace the fuel pump assembly. Due to a manufacturing defect, the impeller inside the fuel pump can warp or swell when exposed to fuel, causing the impeller to lock in place and prevent fuel flow to the engine. A locked impeller can cause the engine to stall without warning while riding.

AFFECTED UNITS

As of February 9, 2024, **YOU MUST NOT SELL CERTAIN NEW or USED** 2020-2024 GL1800/B/BD/D/DA motorcycles until they are repaired according to this Service Bulletin.

- To search for applicable recalls on a specific unit, you **MUST** use *Unit Information* on **iN**.
- To manage your affected new inventory, use your dealer *eResponsibility Report* on **iN**.

CUSTOMER NOTIFICATION

American Honda intends to mail customer letters to all owners of affected 2020-2024 GL1800/B/BD/D/DA motorcycles in April 2024. Customers will be informed that their motorcycle may be affected by a safety related defect and will be advised to make an appointment with an authorized Honda dealer for repair.

PARTS INFORMATION

Parts are under TechLine control. You **MUST** contact TechLine to have the part released.

Model	Description	Part Number	Qty.
GL1800B/BD/D/DA	Fuel Pump Kit	16700-MKC-A01	1
Kit Includes:			
	Description	Part Number	Qty.
	Fuel Pump Set	N/A	1
	Packing, Fuel Pump	17571-MKC-A00	1
	Ring, Fuel Pump Locking	17719-HR3-A21	1

SPECIAL TOOL INFORMATION

The special tools listed below are necessary to perform the repair.

DEALER REPAIR RESPONSIBILITY

- Repairs must be performed by a qualified technician.
- Performing this repair exactly as shown in Repair Procedure instructions is critical for the remedy to be effective. Carefully follow all instructions.
- Service Management should inspect and confirm the repair.
- Dealer submission of a warranty claim affirms this repair was properly performed.

1 of 7

*Fuel Tank Lock Ring Wrench	OTC6599	1
**Fuel Module Separator	07AAF-T5RA100	1 (two pieces)

* The Fuel Tank Lock Ring Wrench is a required Special Tool and was auto-shipped to your dealership in 2014.

** The Fuel Module Separator tool was auto-shipped to your dealership in 2020.

If either tool is missing, the tool can be ordered through the Special Tool and Equipment program.

WARRANTY CLAIM INFORMATION

After completing this *Service Bulletin* update, submit one warranty claim per unit with the following template number. **A photo of the defective fuel pump identification label will be required for all KQ1B replacement claims. If the pump is found to be in the defective range, contact TechLine for further instructions.**

MODEL	TEMPLATE	FLAT RATE
GL1800B/BD/D/DA	Inspection only: KQ1A	0.3
	Replacement: KQ1B	0.8

Note: All KQ1B warranty template claims will reimburse freight. To ensure your dealership receives the freight credit, follow these steps.

1. Make sure 'YES' is selected from the *Freight Involved* drop down window.
2. Make sure to include the *Part Order Reference Number*.
3. Include the freight *Amount* associated with the listed *Part Order Reference Number*.
 - The *Part Order Reference Number* can be found on your *Parts Order Statement* on *iN*.

Template Warranty Claim

Template Number:

Basic Claim Information (required for all claim types)

Claim No.: Repair Order Number:

VIN: Repair Order Date (open):

Mileage: Work Completed Date:

Sublet Involved?

Freight Involved? Freight Information:

Part Order Reference Number: Amount:

Submit Save View Claim CHANGE CLAIM TYPE

DEALER SUPPORT

TECHNICAL QUESTIONS

If you have any technical questions relating to this update procedure, please contact:

Motorcycle TechLine Online:

iN > Service > TechLine > TechLine > TechLine Connect

Or call (800) 421-1900, option 9

WARRANTY QUESTIONS

If you have any warranty administration questions relating to warranty claim templates, and claim filing procedures, please contact:

Motorcycle Warranty Online:

iN > Service > Warranty & HondaCare > Warranty Connect Filing

Or call (800) 421-1900, option 7

RECALL REPAIR IDENTIFICATION

Before you begin the repair procedure, verify that the unit has not already been repaired by searching *Unit Information* on *iN*.

FUEL PUMP INSPECTION

Remove the side covers and seat.

- Refer to the service manual for details.

Inspect the identification label affixed to the top of the fuel pump.



1. Check the part number of the pump.

- For pumps with **-A01** in the part number, proceed to step 2 to check the LOT number.
- For pumps with **-A02** in the part number, the pump does not need to be replaced and no repair is required. Proceed to filing an "Inspection Only" warranty claim.

- Check the LOT number located in the bottom right-hand corner of the label. If the LOT number shows a production date that is before September 27, 2019, the fuel pump must be replaced.

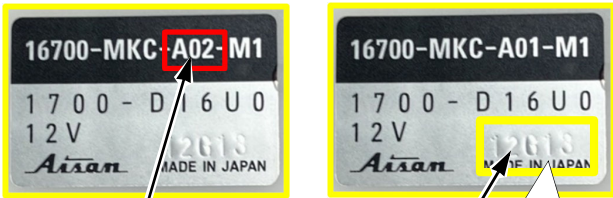

PART NUMBER

LOT NUMBER

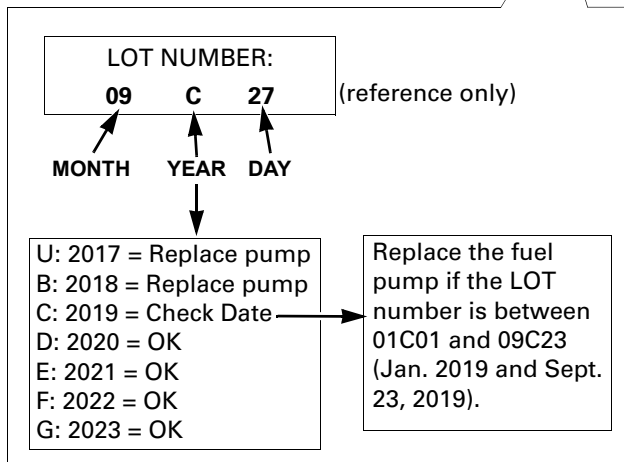

FUEL PUMP REPLACEMENT

SIDE COVERS REMOVAL / INSTALLATION

Open both saddlebags. Release the bosses [1] from the grommets [2] and remove the side covers [3].

NOTES:

- Be careful not to dislodge the grommets.
- Align the side cover tab [4] with the saddlebag upper cover slit [5]

Installation is in the reverse order of removal.

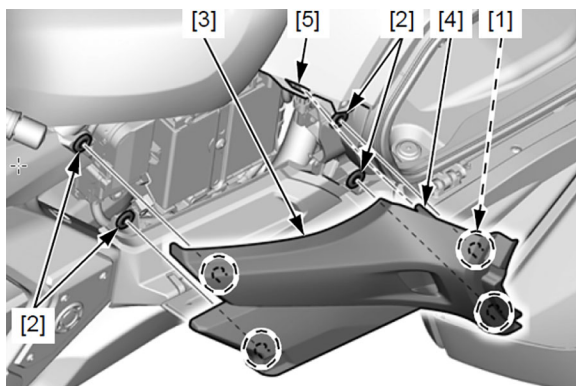

SEAT REMOVAL / INSTALLATION

Tour type only:

Release the seat heater 12P (Black) connector [1] from area near the right saddlebag and disconnect it.

Remove the socket bolts [2], washers [3]. Remove the seat [4]. Remove the collars [5] from the seat.

Installation is in the reverse order of removal, with these notes:

- Align the seat tabs [6] with the grab rail lugs [7].
- Align the seat tab [8] with the top shelter stay slot [9].
- Align the seat bosses [10] with the top shelter grommets [11].

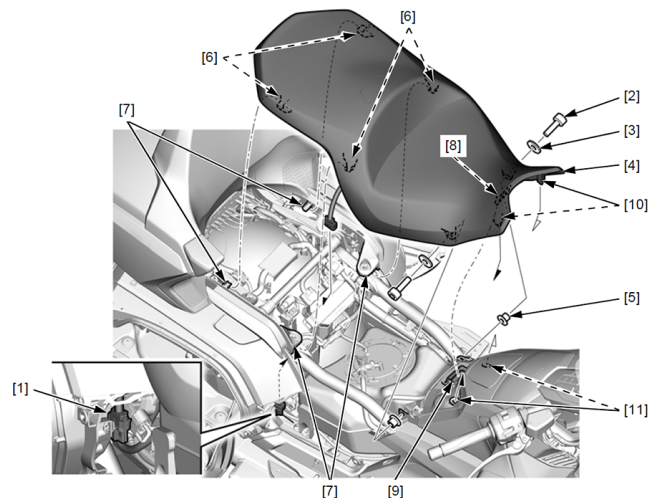

FUEL PRESSURE RELIEVING

Before disconnecting the fuel hose, relieve any fuel pressure from the system as follows.

- Disconnect the fuel pump unit 4P (Gray) connector [1].

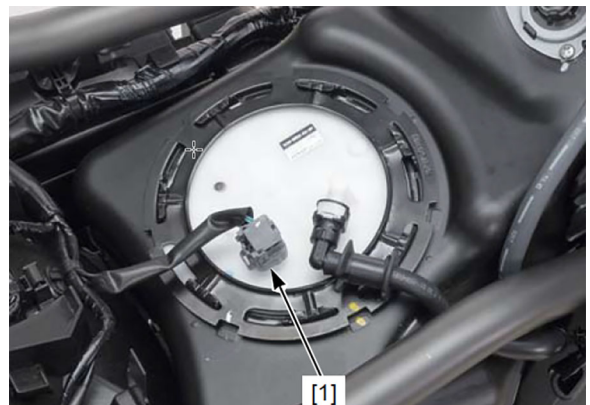

2. Start the engine and let it idle until the engine stalls.
3. Turn the ignition switch OFF.

FUEL REMOVAL / REFILL

Remove the fuel from the fuel tank so that the fuel gauge [1] shows less than half (three segments) before removing the fuel pump.

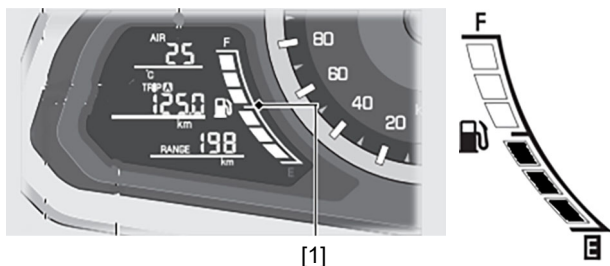

Drain the fuel into a clean container for refilling the tank after procedure is complete.

FUEL PUMP REMOVAL / INSTALLATION

NOTES:

- Clean around the quick connect fitting before disconnecting the fuel feed hose, and be sure that no dirt is allowed to enter into the fuel system.
- Do not bend or twist the fuel feed hose.
- Disconnect the battery negative (-) cable [1] from the negative (-) battery terminal [2].

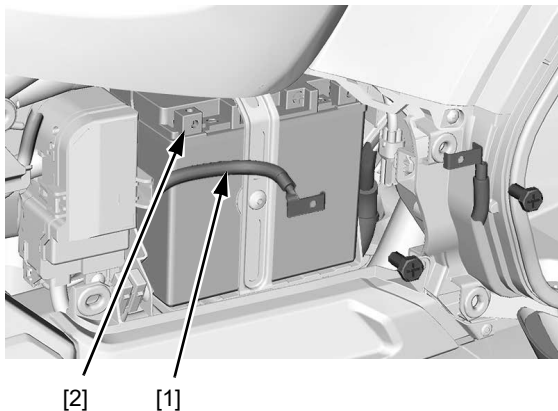

- Push the retainer tab [2] forward. Press down the retainer [3] and disconnect the connector [4] from the fuel pump joint or fuel pipe joint.

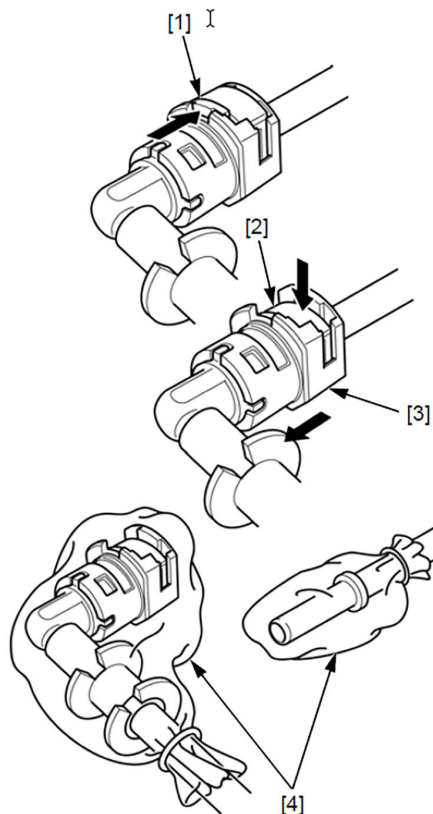

- To prevent damage and keep foreign matter out, cover the disconnected connector and joint end with the plastic bags.

1. Remove the fuel pump locking ring [1] by rotating it counterclockwise using the special tool.



SPECIAL TOOL:

Wrench, fuel sender [2]	070AA-TBA0100
-------------------------	---------------

NOTE:

It is recommended to use a long handle wrench to remove the fuel pump locking ring.

2. Remove the locking ring and fuel pump assembly [3] from the fuel tank.

NOTICE:

Be careful when releasing the locking ring. It is possible that the fuel pump can jump upwards because it is installed under tension by a spring.

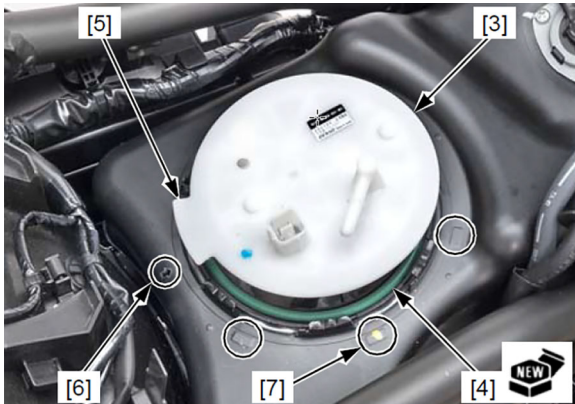

3. Remove the O-ring [4]. Clean the O-ring seating area of the fuel tank, and be sure that no foreign materials enter the tank.

NOTICE:

When the fuel pump is removed from the tank, there may still be fuel in the pump. To prevent the fuel from leaking, the pump should be kept straight up, and then placed in a fuel safe collection container.

Installation is the reverse order of removal.

- Install a new O-ring into the fuel tank groove.
- Install the fuel pump assembly into the fuel tank by aligning the tab [5] with the arrow mark [6] on the fuel tank.
- Install and tighten a new locking ring by rotating it clockwise using the special tool.
- Make sure that the locking ring grooves align with the index marks [7] on the fuel tank. Connect the quick connect fitting to the fuel pump.
- Be sure to press the connector onto the fuel pump joint or fuel pipe joint until the retainer locks with a "CLICK." If it is hard to connect, put a small amount of engine oil on the joint end. Make sure the connection is secure; check visually and by pulling the connector.

Connect the battery negative (-) cable [1] to the negative (-) battery terminal [2].

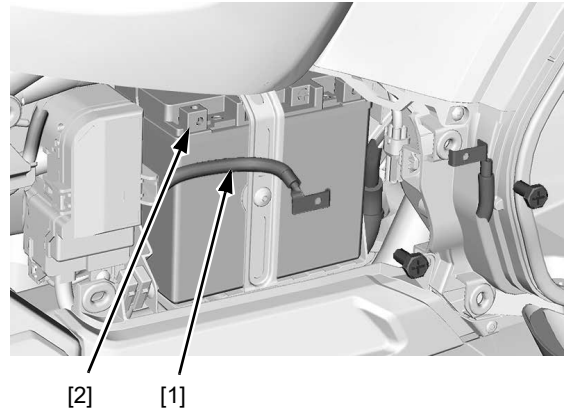

FUEL PUMP DISASSEMBLY / ASSEMBLY

1. Disconnect the fuel pump 2P connector [1] and fuel reserve sensor 2P (Brown) connector [2]. Release the wires from the clamps [3].

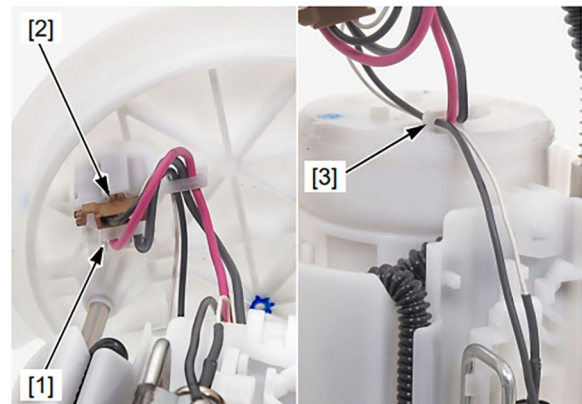

2. Remove cap A [1] and release the return hose [2] from the reservoir [3].

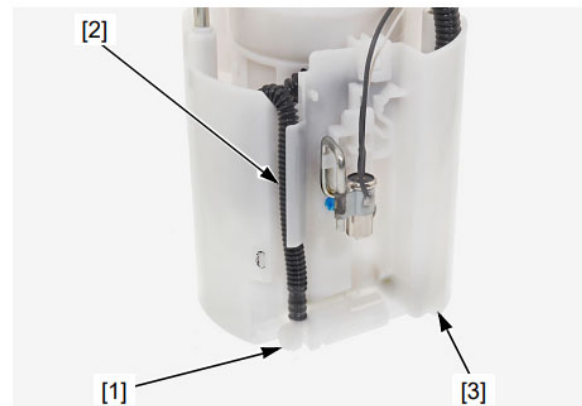

3. Push the pump flange [1] and remove the E-ring [2] from the rod end. Remove the pump flange/rods from the reservoir, then remove the spring [3] from the rod. Remove the fuel pump/strainer assembly [4] from the reservoir [5] by releasing the three tabs [6].

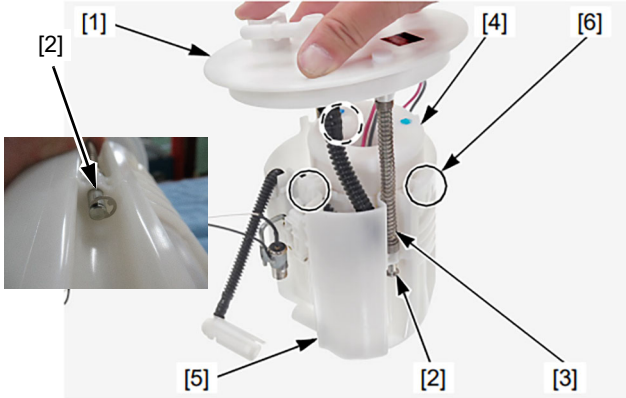

4. Insert the protruding part of the Special Service Tool (SST) in the lock tab (under the claw). Press the SST up until it clicks. Repeat this process using a second SST for the second lock tab.

NOTE:
 After insertion, make sure the lock tab is raised.

Before inserting SST After inserting SST

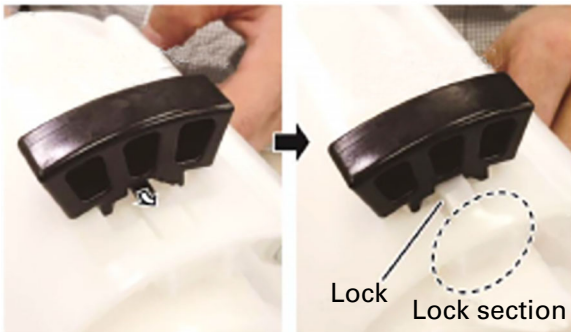

Image of installed SST.



5. With the two lock tabs released, use a screwdriver to remove the remaining lock tab.

NOTICE:
 Be careful to not spread the lock tab too wide or it may be damaged. If a lock tab is damaged, contact TechLine for further instructions.



6. Remove the strainer bracket [1] from the strainer case by releasing the tab [2].

Image for reference only

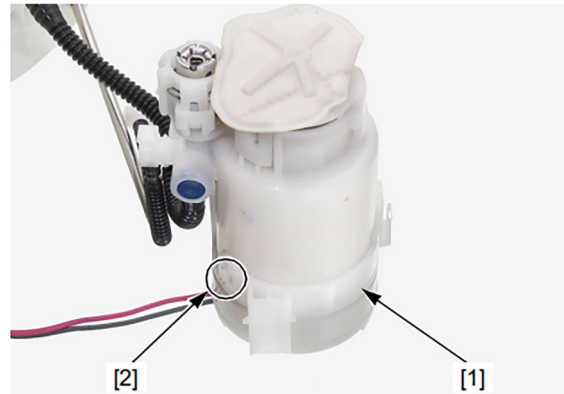

7. Remove the fuel pump/filter assembly [1] from the strainer case [2] by releasing the three tabs [3].

Image for reference only

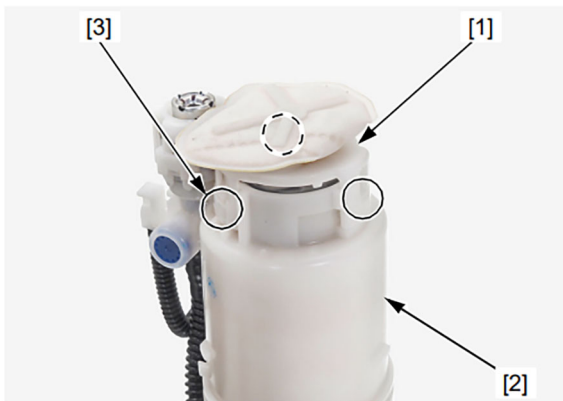

8. Disconnect the 2P connector [1] from the fuel pump/ filter assembly [2].
Remove the O-ring [3] and spacer [4] from the fuel pump/filter assembly.

Make sure to remove O-ring [3] from strainer case.

Apply engine oil to both O-ring s[3] when installing.

Assembly is in the reverse order of disassembly.

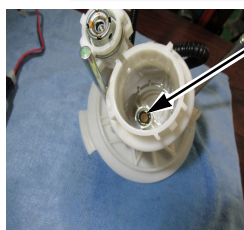
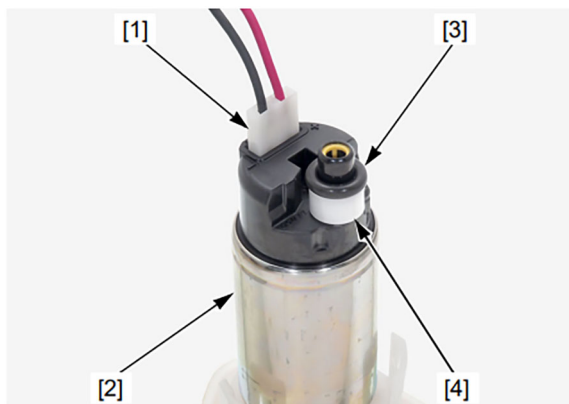

Installation is reverse order of this procedure.

FUEL PRESSURE NORMALIZATION

1. Refill the fuel tank with previously drained fuel.
2. Connect the fuel pump unit 4P (Gray) connector [1].

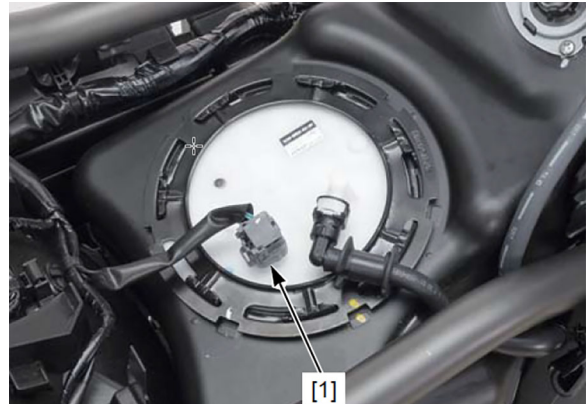

3. Turn the ignition switch ON. The fuel pump will run for about 2 seconds and fuel pressure will rise.
4. Turn the ignition switch OFF.
5. Repeat steps 3 and 4 two or three times, and check that there is no leakage in the fuel supply system.
6. Start the engine to verify proper engine operation and check for leaks.

Reassemble the unit.