



# Technical Service Bulletin

<b>GROUP</b>	<b>NUMBER</b>
<b>RECALL</b>	<b>25-01-004G</b>
<b>DATE</b>	<b>MODEL(S)</b>
<b>JANUARY 2025</b>	<b>G70 (IK) G80 (DH) G90 (HI)</b>

**SUBJECT:** STARTER RELAY KIT INSTALLATION (RECALL 018G)

This TSB supersedes 24-01-058G to enhance Starter Relay Kit Installation step 9 on page 15.

## ★ IMPORTANT

Vehicle repairs related to safety recalls are critically important and must be performed properly in accordance with TSB procedures. Review this bulletin in its entirety prior to beginning any repair work.

As required by federal law, retailers must not deliver new vehicles for sale or for lease to guests until all open recalls have been performed. Retailers must also perform all open recalls on used vehicles, demo, and rental vehicles prior to placing them into guest use and whenever an affected vehicle is in the shop for any maintenance or repair.

Access the **Vehicle Information** screen via WebDCS to identify open recalls.

**Description:** Certain 2019MY G70 (IK), 2017-2019MY G80 (DH), and 2017-2019MY G90 (HI) vehicles may exhibit starter damage while parked or driving in abnormally wet conditions, such as a flooded road. This may be due to moisture contamination within the starter solenoid causing an electrical short over time. Follow the procedure in this TSB to install a new starter relay kit in the engine room junction box, and to replace the upper cover and upper cover label.

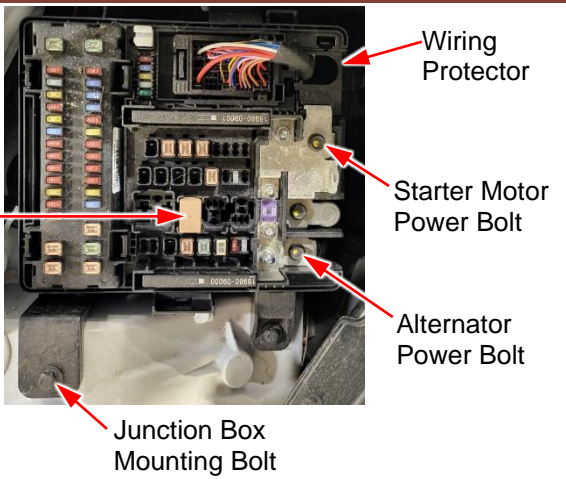
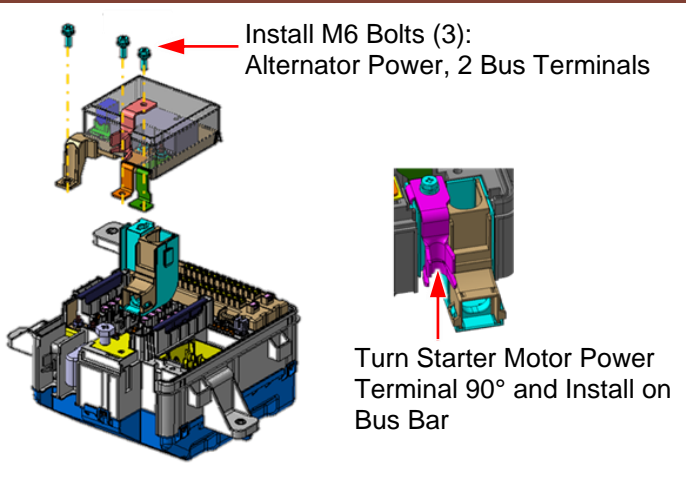
Current Configuration	New Starter Relay Kit Installation
	

**Key 1st step:** When looking up the VIN in the **Vehicle Information** screen, make sure to go to the **Campaign Not Performed** section and view the **Campaign Description** field.

- The Op. Code will indicate which part number to install. In this particular Op. Code, the part number **91955-DH45KQQH** needs to be installed.

Campaign Code	Recall	Campaign Description	Campaign Start Date	Vin Activation Date
019G	Y	OIL FEED PIPE REPLACE (24-01-032G/HG)	04/18/2024	04/18/2024
018G	Y	41D086R0 - RELAY KIT (P/N 91955-DH45KQQH)	02/15/2024	02/15/2024

#### Applicable Vehicles (Certain):

- 2019MY G70 (IK) produced from 05/02/2018 – 01/26/2019
- 2017-2019MY G80 (DH) produced from 03/17/2016 – 01/04/2019
- 2017-2019MY G90 (HI) produced from 06/13/2016 – 01/22/2019

#### Parts Information:

Model	Part Name	Part Number	Kit Contents (1 each)	Remarks
G70 (IK)	Relay A/S Kit	91955-IK10KQQH	<ul style="list-style-type: none"> <li>Relay Kit</li> <li>Upper Cover (w/Label)</li> <li>Relay A/S Kit Protector Body</li> <li>Relay A/S Kit Protector Cover</li> <li>Bolt Set</li> </ul>	

**Note:** Please refer to the **Vehicle Information** screen in WebDCS for the part number that needs to be installed on the vehicle.



Model	Part Name	Part Number	Kit Contents (1 each)	Remarks
G80 (DH)	Relay A/S Kit	91950-DH15KQQH	<ul style="list-style-type: none"> <li>Relay Kit</li> <li>Upper Cover (w/Label)</li> </ul>	Use Label 91950-B110K
		91955-DH45KQQH	<ul style="list-style-type: none"> <li>Relay A/S Kit Protector Body</li> </ul>	Use Label 91955-B140K
		91955-DH50KQQH	<ul style="list-style-type: none"> <li>Relay A/S Kit Protector Cover</li> <li>Bolt Set</li> </ul>	Use Label 91955-B150K

Model	Part Name	Part Number	Kit Contents (1 each)	Remarks
G90 (HI)	Relay A/S Kit	91950-HI20KQQH	<ul style="list-style-type: none"> <li>Relay Kit</li> <li>Upper Cover (w/Label)</li> <li>Relay A/S Kit Protector Body</li> <li>Relay A/S Kit Protector Cover</li> <li>Bolt Set</li> </ul>	

Figure (Samples Shown)



**Required Supplies:**

Name	Figure	Remarks	Qty
Cable (zip) Tie		<ul style="list-style-type: none"> <li>Locally sourced part</li> <li>Width: <b>5 mm (~3/16")</b></li> <li>Approx. Length: <b>200 mm (7-7/8")</b></li> </ul>	1
Needle Nose Pliers		<ul style="list-style-type: none"> <li>Locally Sourced Part</li> </ul>	1

**Warranty Information:**

Model	Op. Code	Operation	Op. Time	Causal Part	Nature Code	Cause Code
G80 (DH)	41D086R0	Starter Relay Kit Installation (P/N 91955-DH45KQQH)	0.5 M/H	36100-3C240	I14	ZZ3
	41D086R1	Starter Relay Kit Installation (P/N 91955-DH50KQQH)				
	41D086R4	Starter Relay Kit Installation (P/N 91950-DH15KQQH)				
G70 (IK)	41D086R2	Starter Relay Kit Installation (P/N 91950-IK10KQQH)				
G90(HI)	41D086R3	Starter Relay Kit Installation (P/N 91950-HI20KQQH)				

**NOTE 1:** Submit claim on **Claim Entry** Screen as **Campaign** type.

**NOTE 2:** If a part is found in need of replacement while performing this recall and the affected part is still under warranty, submit a separate claim using the same repair order. If the affected part is out of warranty, submit a Prior Approval request for goodwill consideration prior to performing the work.

**NOTE 3:** This TSB includes Repair validation photos. Op. Times include VIN, Mileage, and Repair validation photos as outlined in the Digital Documentation Policy.

**NOTE 4:** Dealer will be reimbursed **\$.48** through sublet under all Op. Codes for cable tie and any necessary clips requiring replacement.

**Service Procedure:****STUI**

This TSB includes Repair validation photos. Refer to the latest Warranty Digital Documentation Policy for requirements.

Service Procedure Flowchart:

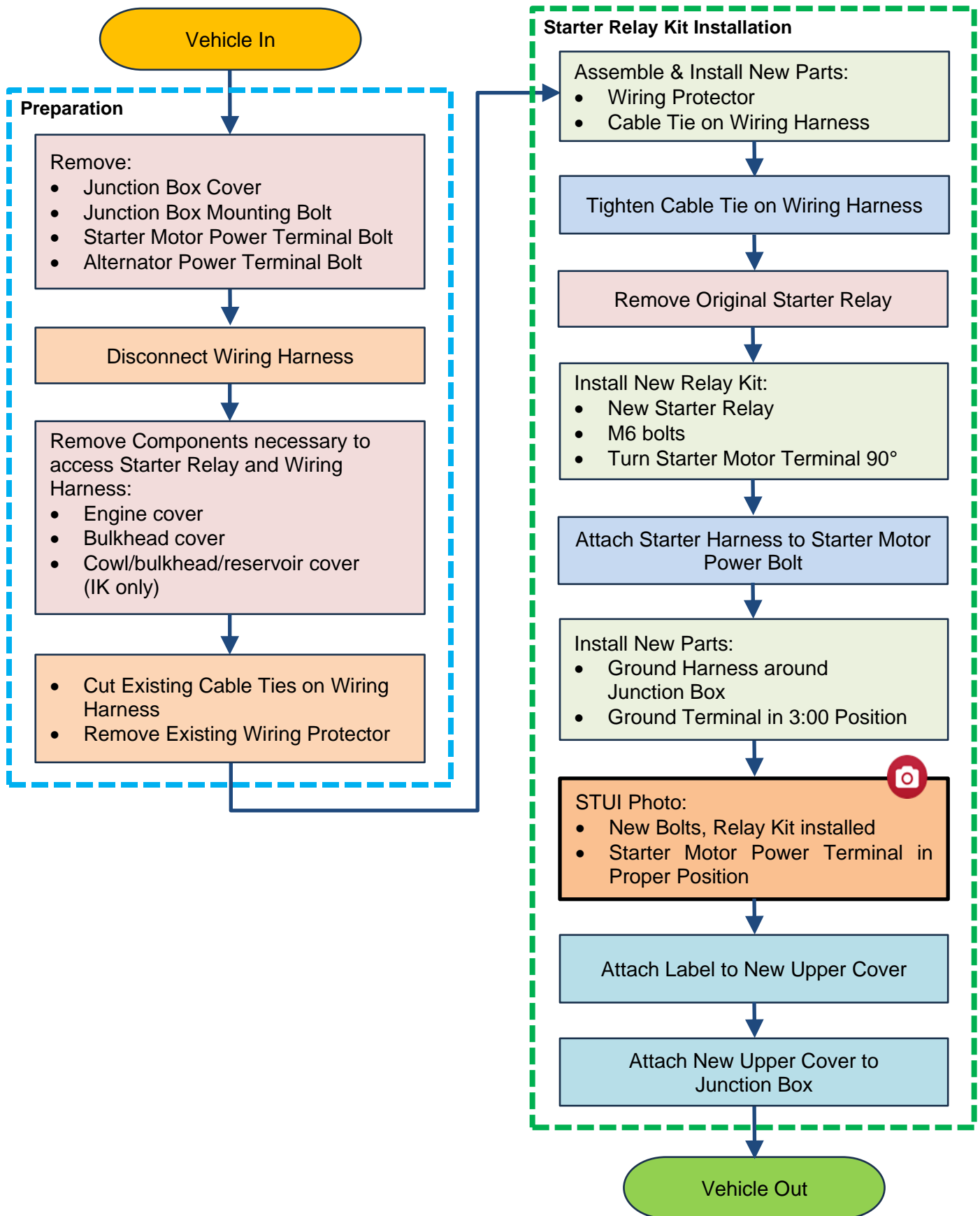

## Preparation

1. Record customer's radio presets, then disconnect the negative (-) battery terminal.
2. Remove the junction box cover.
3. Remove the junction box mounting bolt (A), starter motor power terminal bolt (B), the alternator power terminal bolt (C) and disconnect the harness (D) from the junction box.

**i** Information

G70 (IK): Proceed to [Step 4a](#).

G80 (DH): Proceed to [Step 4b](#).

G90 (HI): Proceed to [Step 4c](#).

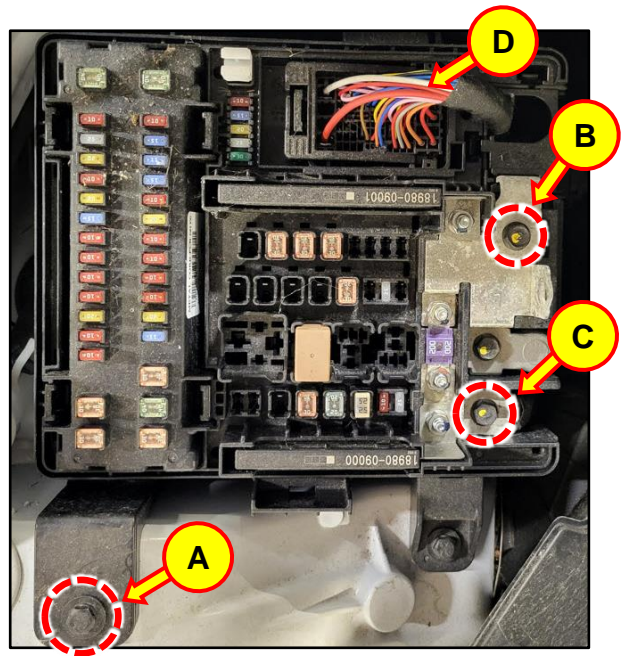

- 4a. **G70 (IK):** Remove three clips (E) and bulkhead cover (F).

**i** Information

**Note:** Replace any broken clips (P/N: 86155-2H100).

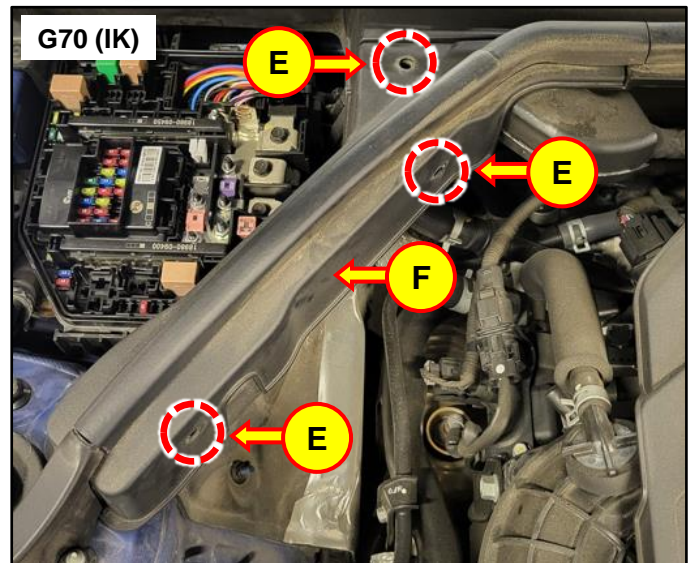

**G70 (IK):** Disconnect the washer fluid hose (G) and remove two clips (H) from the passenger-side cowl.

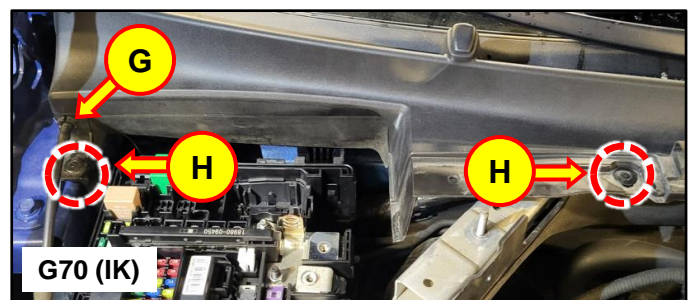

**G70 (IK):** Remove two clips (I) from the driver side bulkhead cover.

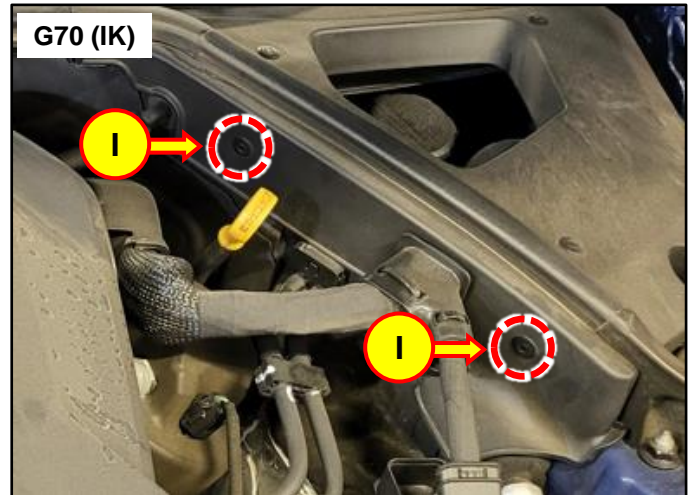

**G70 (IK):** Remove both wiper arms (J) and lift the entire cowl, driver side bulkhead and brake reservoir cover (K) out of the way and set aside.

**Proceed to step 5.**

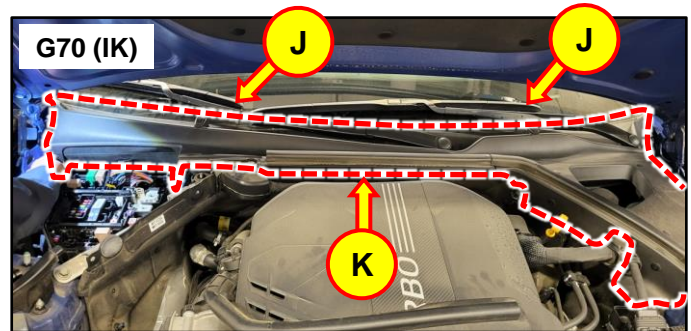

- 4b. **G80 (DH):** Remove three clips (L) and 10 mm bolt (M) from the bulkhead cover (N).

**i** Information

**Note:** Replace any broken clips (P/N: 86155-2H100).

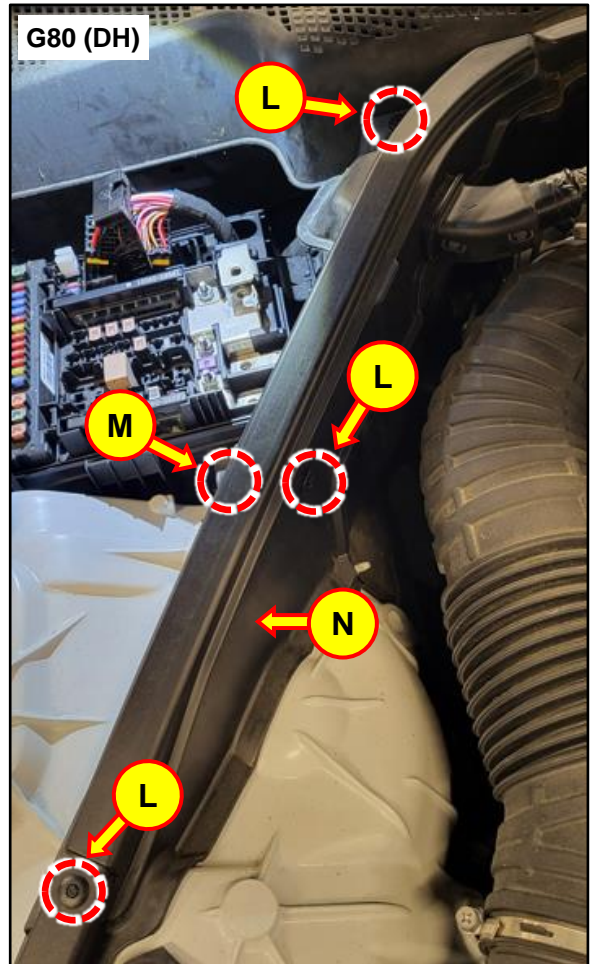

**G80 (DH):** Lift the engine cover and remove the clip (O) underneath to remove the bulkhead cover.

**Proceed to step 5.**

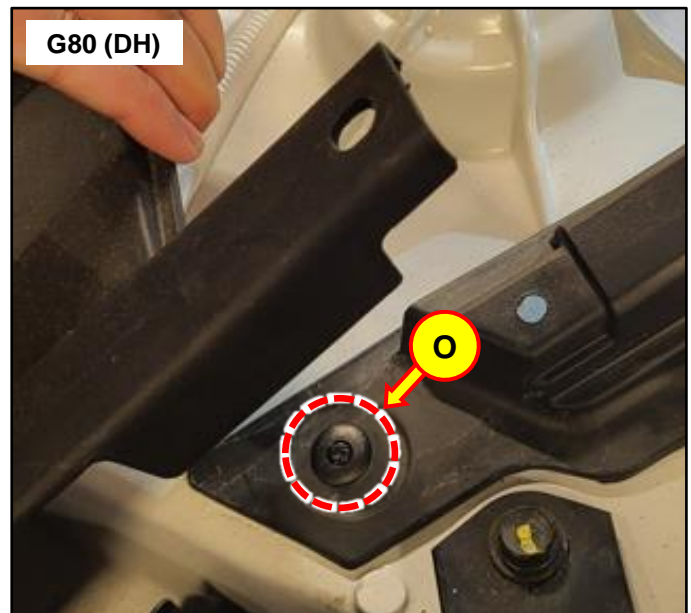

4c. **G90 (HI):** Remove four clips (P).

**Information**

**Note:** Replace any broken clips  
(P/N: 86155-2H100).

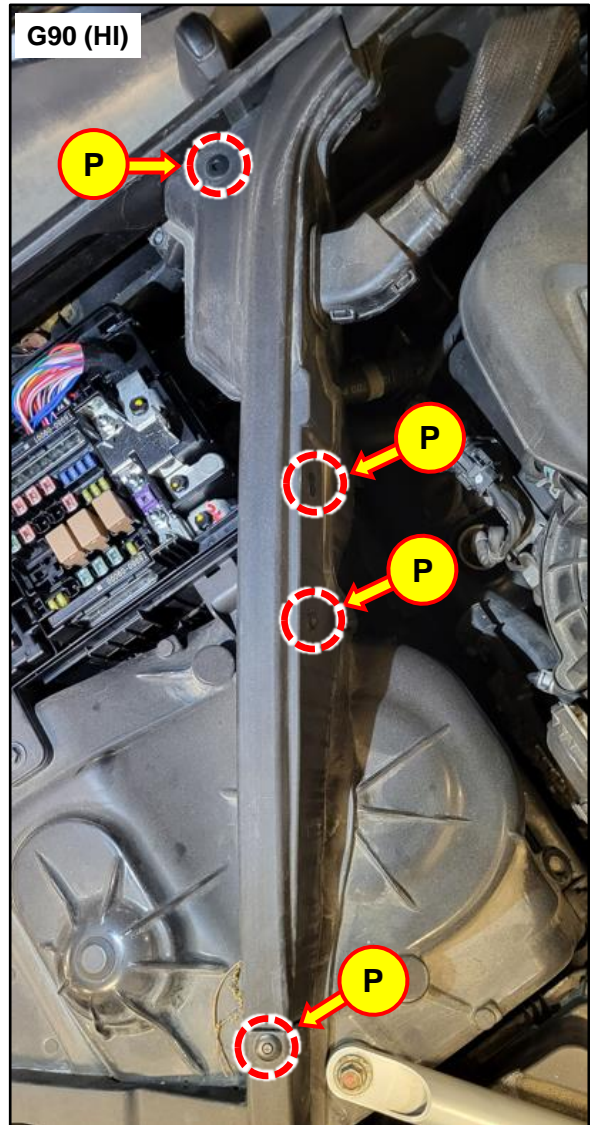

**G90 (HI):** Lift the engine cover and remove the clip (Q) underneath to remove the bulkhead cover.

**Proceed to step 5.**

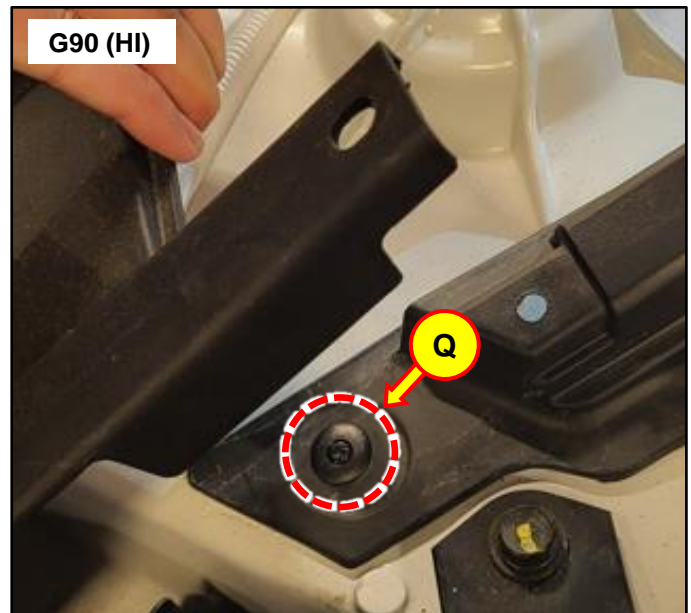

5. Remove two **10 mm** nuts (R) from the harness bulkhead.

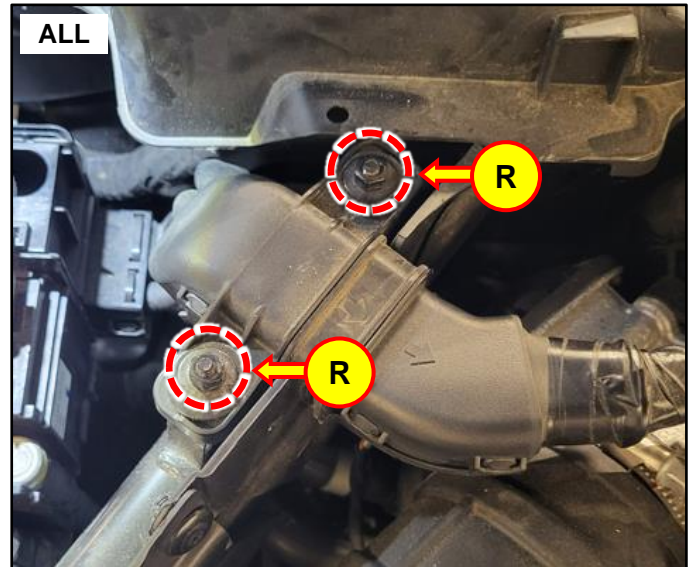

6. Remove the cable ties on the connector wiring and remove the existing wiring protector (S).

**NOTICE**

Be careful **NOT** to damage the wiring.

**Information**

The wiring protector will be replaced.

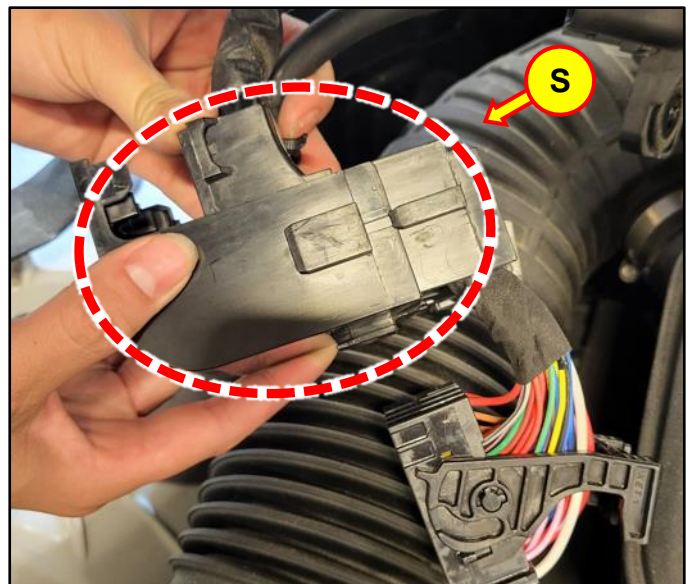
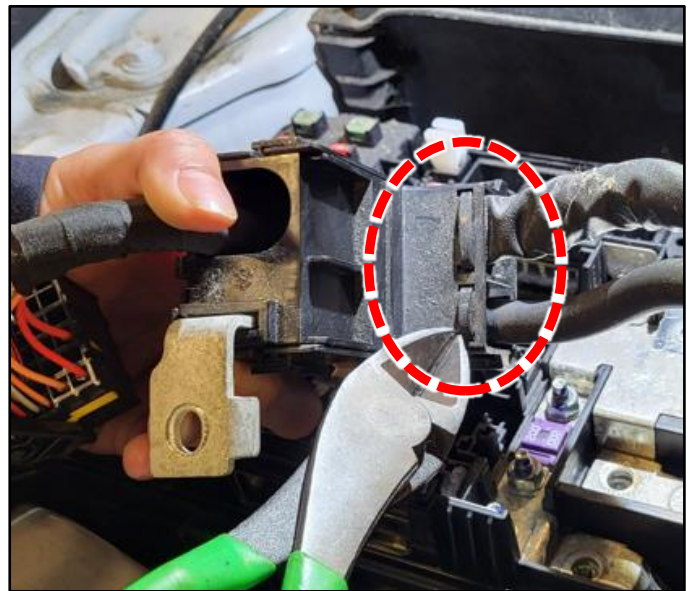

Starter Relay Kit Installation

- 1. Assemble the new wiring protector upper cover (A) by inserting the wiring harness through the opening, then loosely secure the cable tie (B) around the wiring as shown.

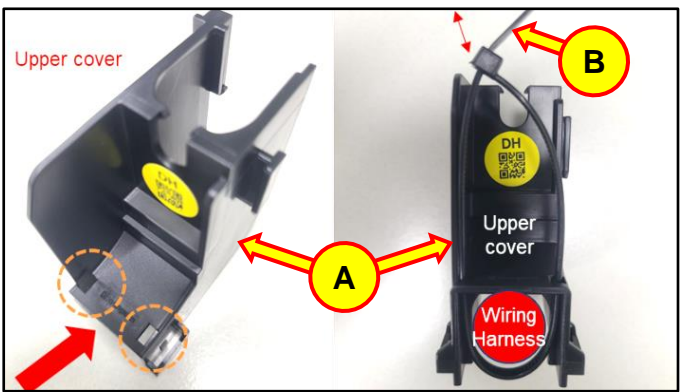

- 2. Assemble the protector body (C) with the protector upper cover.

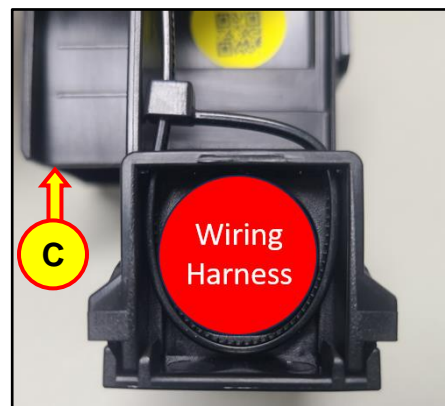

- 3. Install the assembled new wiring protector (D) into the junction box in the **NEW** configuration shown at right.

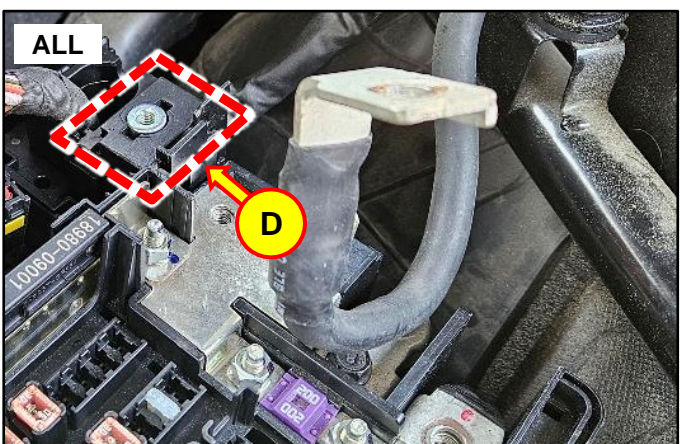
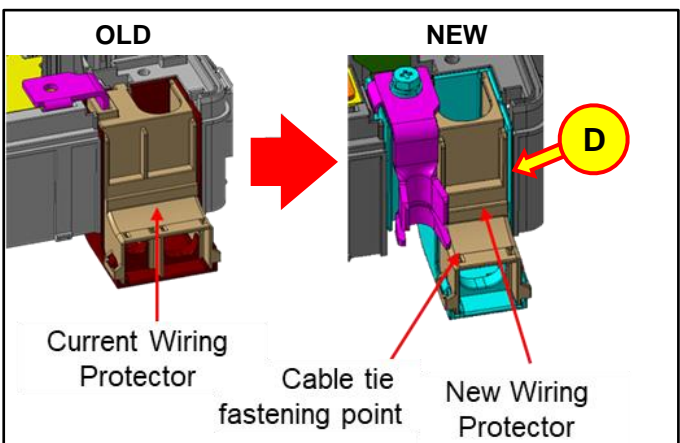

- Tighten the cable tie (E) completely using needle nose pliers.

**NOTICE**

Be careful **NOT** to pull or interfere with any connectors while tightening the cable tie.

Needle Nose Pliers

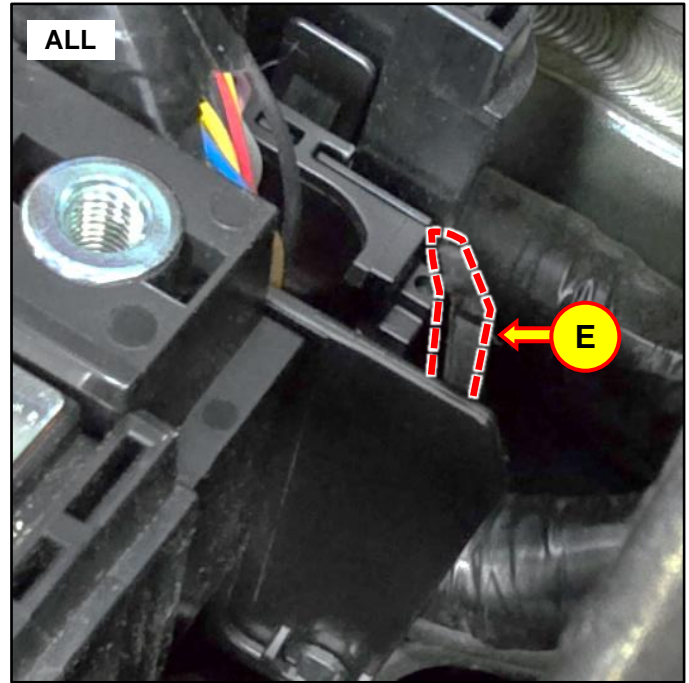

- Remove and discard the original starter relay (F).

**i Information**

Refer to the fuse diagram in the junction box cover to identify the starter relay.

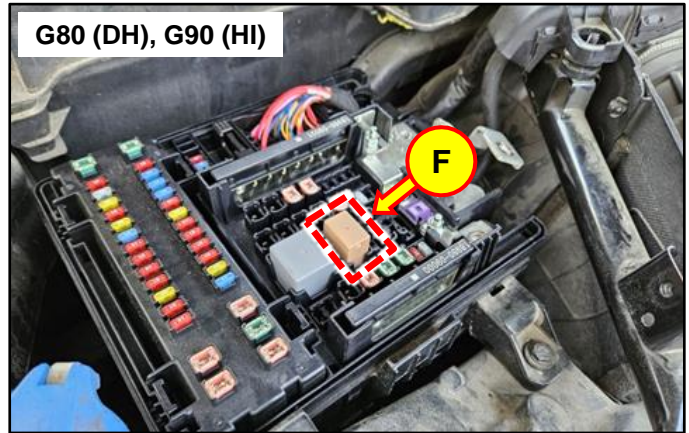

**G70 (IK)**

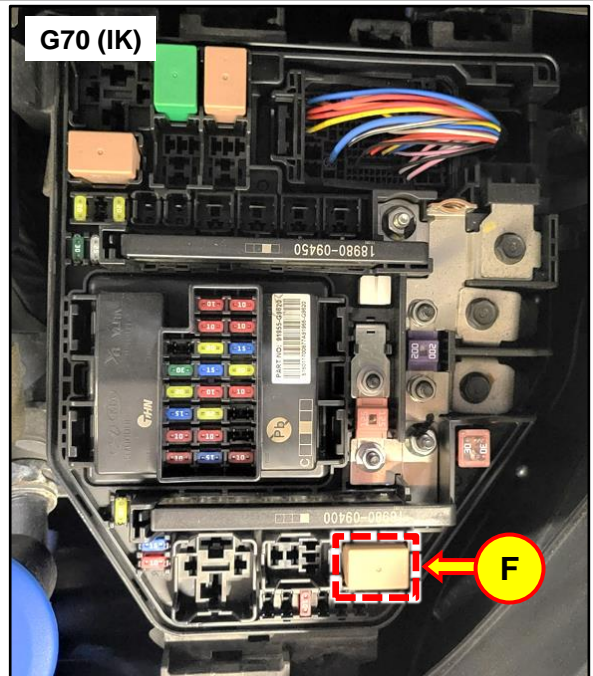

6. Install the provided relay kit (G) onto the junction box, paying close attention to the installation details below.

- Install the new starter relay to the specified position carefully.
- Install the three provided **M6** bolts to the alternator power bolt and two bus terminals.

**Tightening Torque:**

lb-ft	0.9
lb-in	10.8
N.m	1.2

- Turn the starter motor power terminal (H) **90°** as shown and install it onto the bus bar.
- Attach the starter harness (G) to the starter motor power bolt.

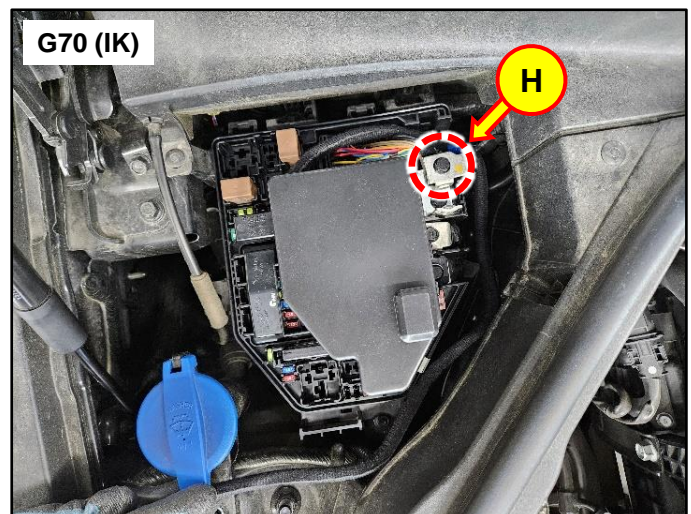
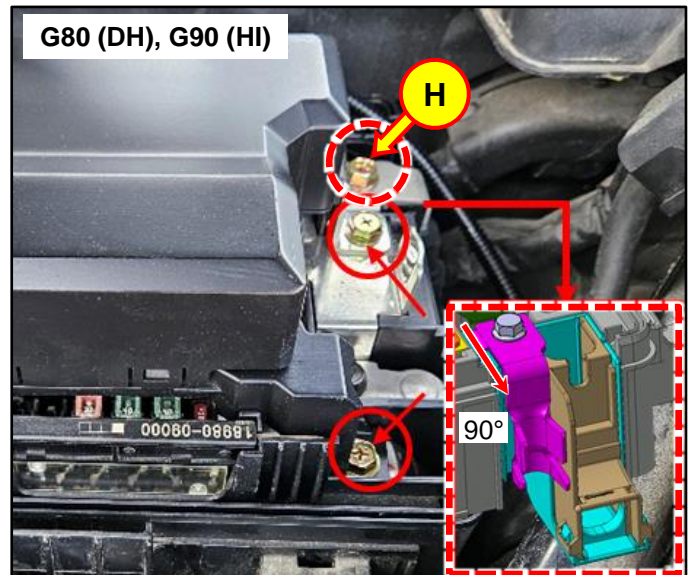
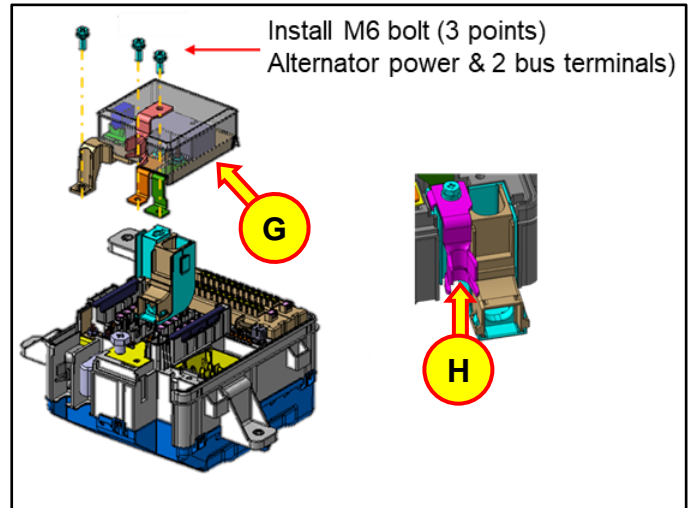

**NOTICE**

On some vehicles, interference may be found between the new starter relay and the blower RR relay installed in the junction box. This interference may **NOT** allow the new starter relay to seat properly.

If there is interference between the parts, use a pair of diagonal cutters to cut away the area indicated in the photo (I).

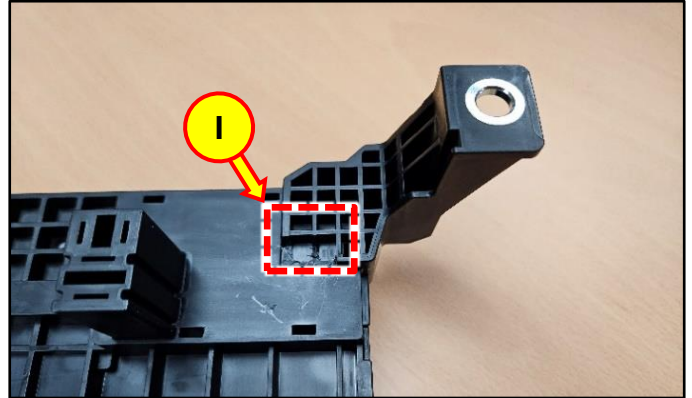
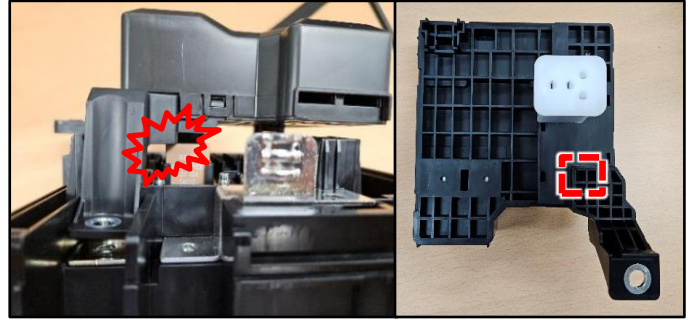

7. Install the ground harness (J) around the junction box.

**NOTICE**

Ensure the ground harness does **NOT** interfere with surrounding components when installed.

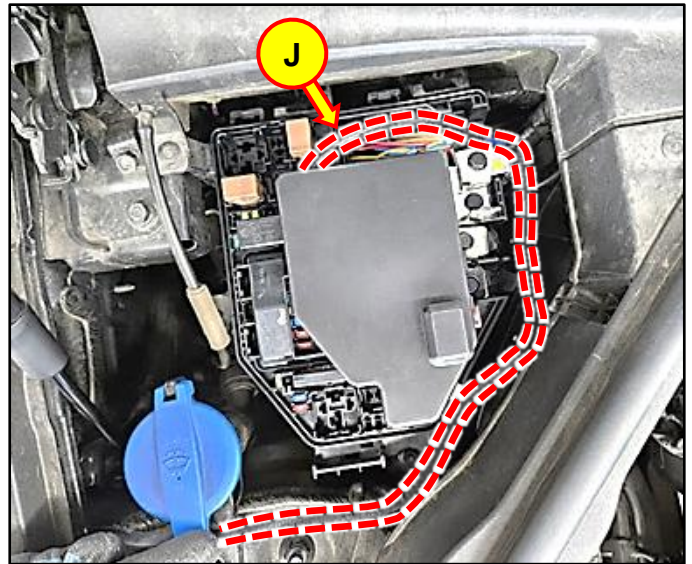

8. Align the blue taped area (K) of the harness in the new protector cover hole as shown.

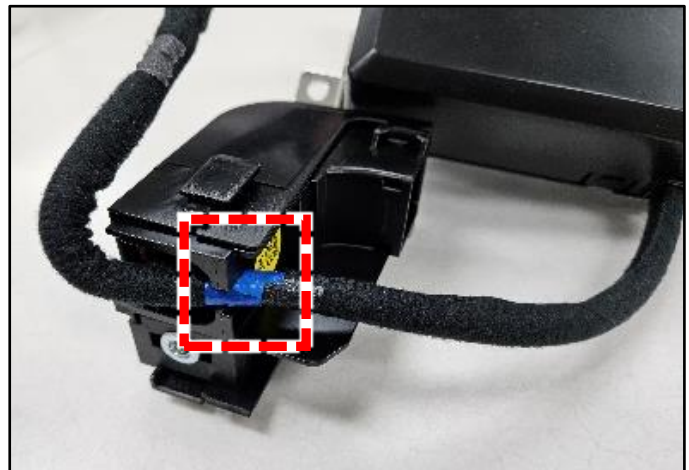
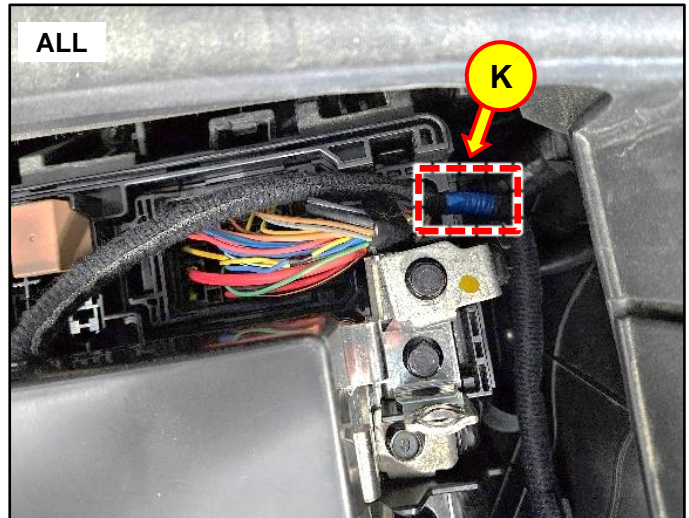

9. Discard the original junction box mounting bolt and use the provided ground bolt (circled right) to install the extension ground terminal (L) from the new relay kit using the existing junction box mounting location (M).

**Tightening Torque:**

lb-ft	0.9
lb-in	10.8
N.m	1.2

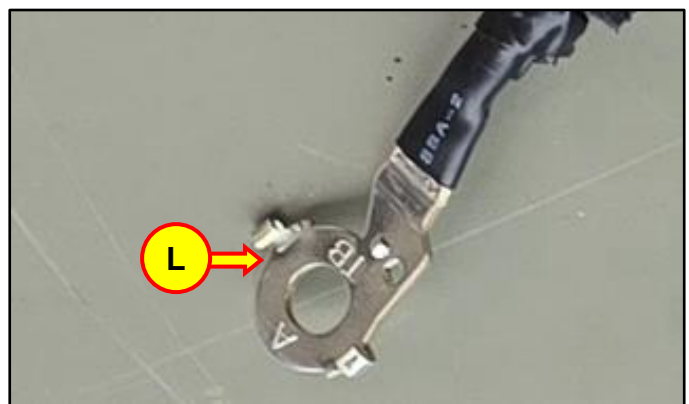

**NOTICE**

Do **NOT** exceed the tightening torque above. This may damage the part.

**NOTICE**

Be sure to install the ground terminal with the protrusion facing up to prevent damaging the terminal.



**Information**

The ground harness should be installed in the **3 o'clock** position, as shown.

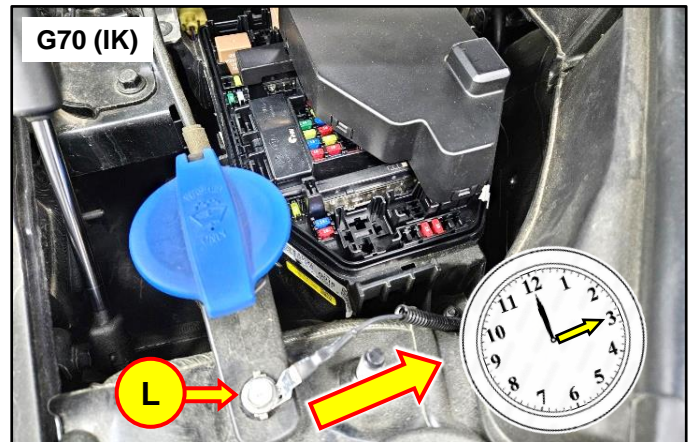
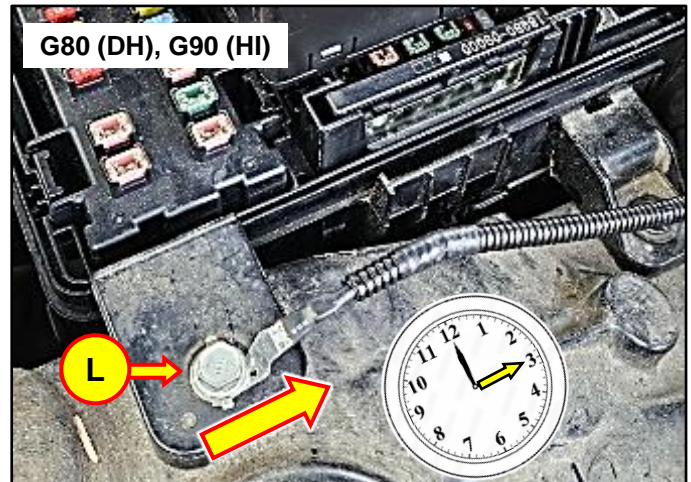
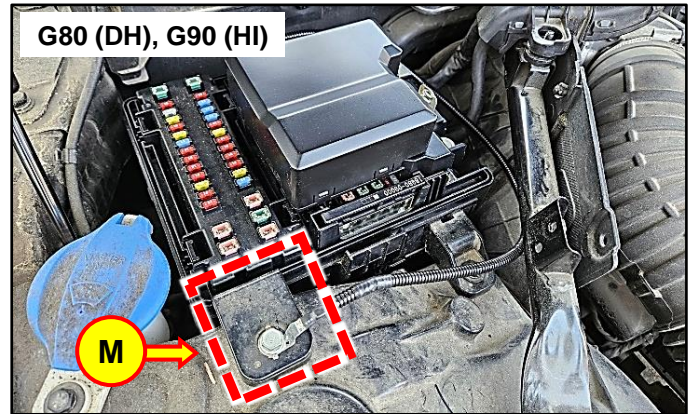

10.

**STUI**

Using STUI, take a clear photo of the new bolts and relay kit installed, and the starter motor power terminal in the proper position, with the last 6 digits of the VIN and the date of repair on a piece of paper.

Upload the photo to STUI.

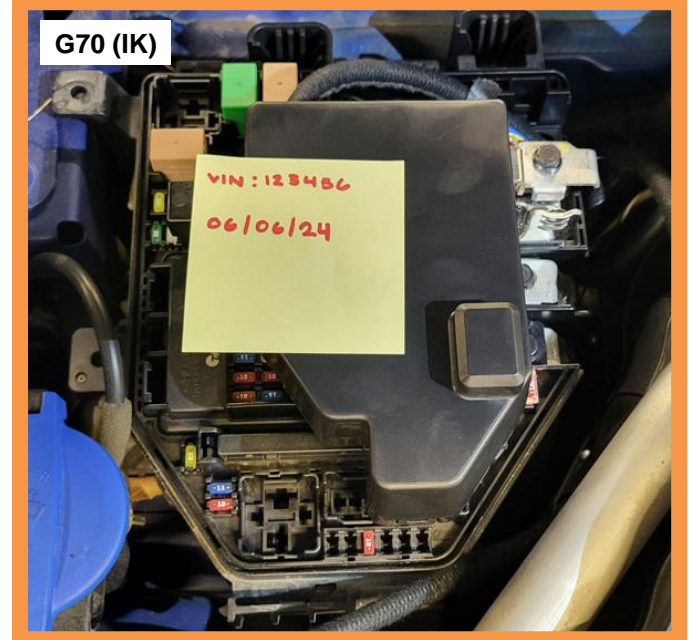

11. Attach the provided upper cover label (N) to the inside of the new upper cover (O) in the same direction as the current upper cover.



**Information**

Be sure to attach the label smoothly and securely, without wrinkles or bumps.

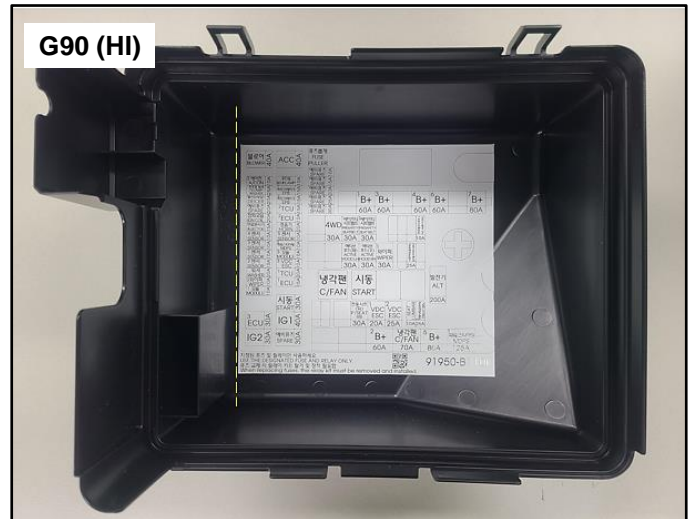
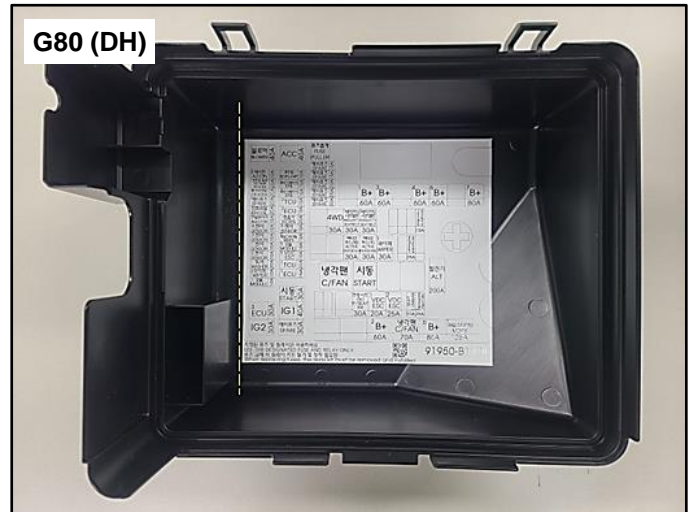
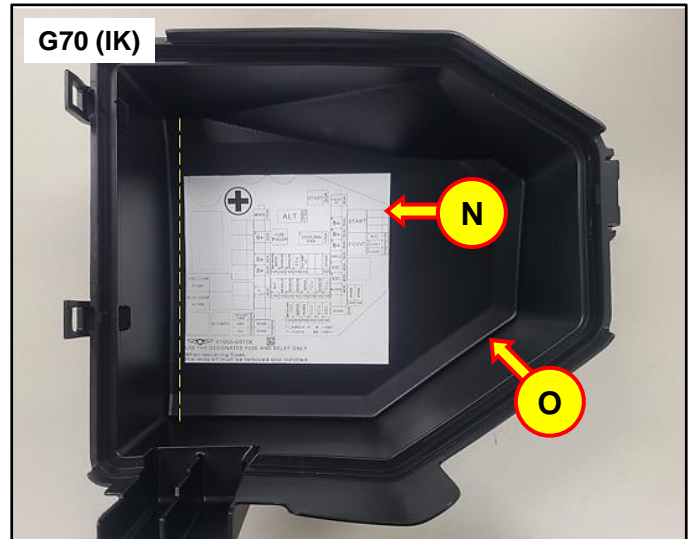

12. Attach the new upper cover to the junction box.

**i** Information

Confirm that the ground harness is installed in the **3 o'clock** position, as shown.



13. Reinstall all removed components in the reverse order of disassembly.
14. Reconnect the negative (-) battery terminal, and reset the customer's radio presets.
15. Procedure is complete.