



VOLUNTARY RECALL CAMPAIGN

Classification: AN24-001A	Reference: NTB24-034A	Date: October 9, 2024
------------------------------	--------------------------	--------------------------

VOLUNTARY SAFETY RECALL CAMPAIGN 2018-2022 LEAF; REAR CAMERA

This bulletin has been amended. See AMENDMENT HISTORY on the last page.
Please discard previous versions of this bulletin.

CAMPAIGN ID #: R23D7
APPLIED VEHICLES: 2018-2022 LEAF (ZE1)

**Check Service COMM or Dealer Business Systems (DBS)
National Service History to confirm campaign eligibility.**

INTRODUCTION

Nissan is conducting this voluntary safety recall campaign on certain specific model year 2018-2022 LEAF vehicles to inspect the rear camera operation and either add support to the rear camera harness or, if necessary, replace the rear camera. This service will be performed at no charge to the customer for parts or labor.

IDENTIFICATION NUMBER

Nissan has assigned identification number R23D7 to this campaign. This number must appear on all communication and documentation of any nature dealing with this campaign.

DEALER RESPONSIBILITY

It is the dealer's responsibility to check Service COMM or Dealer Business Systems (DBS) National Service History for the campaign status on each vehicle falling within the range of this voluntary safety recall which for any reason enters the service department. This includes vehicles purchased from private parties or presented by transient (tourist) owners and vehicles in a dealer's inventory. **Federal law requires that new vehicles in dealer inventory which are the subject of a safety recall must be corrected prior to sale. Failure to do so can result in civil penalties by the National Highway Traffic Safety Administration.** While federal law applies only to new vehicles, Nissan strongly encourages dealers to correct any used vehicles in their inventory before they are retailed.

Bulletins are intended for use by qualified technicians, not 'do-it-yourselfers'. Qualified technicians are properly trained individuals who have the equipment, tools, safety instruction, and know-how to do a job properly and safely. **NOTE:** If you believe that a described condition may apply to a particular vehicle, DO NOT assume that it does. See your Nissan dealer to determine if this applies to your vehicle.

REPAIR OVERVIEW

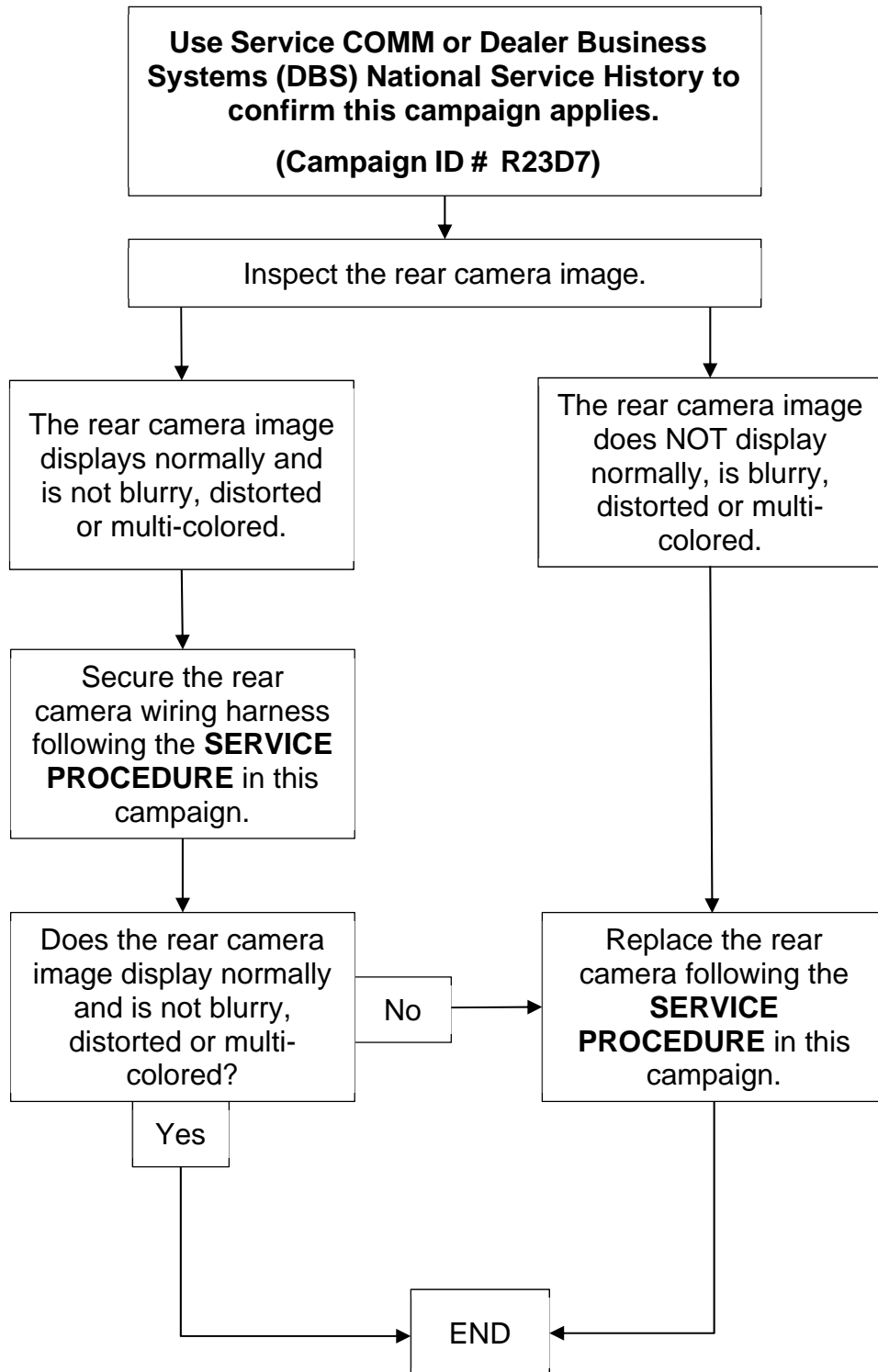

SERVICE PROCEDURE

1. Clean the rear camera lens located on the back door using a suitable soft cloth and glass cleaner.
2. Put the vehicle in READY Mode by pressing the power switch one (1) time WHILE depressing the brake pedal.
3. Set the electric parking brake.
4. While depressing the brake pedal, shift the vehicle into reverse (**R**), and then check that the camera image is NOT blurry, distorted, or multi-colored.
5. Does the rear camera image display normally? (It is NOT blurry, distorted, or multi-colored.)

YES: The rear camera's image is NOT blurry, distorted, or multi-colored.

- Proceed to step 6 to secure the rear camera wiring harness.

NO: The rear camera's image is blurry, distorted, or is multi-colored.

- Replace the rear camera. Refer to the ESM: **DRIVER INFORMATION & MULTIMEDIA > AUDIO, VISUAL & NAVIGATION SYSTEM > REAR VIEW MONITOR SYSTEM > WITH NAVIGATION SYSTEM > REMOVAL AND INSTALLATION > REAR CAMERA: Removal & Installation**

6. Fully open the back door.
 - Install fender covers to protect rear bumper from damage.



Fender Cover

Figure 1

7. Remove the rear parcel shelf finisher.
 - a. Unhook the straps from the back door side finishers.
 - b. Lift the rear parcel shelf finisher and slide it out of the vehicle.
 - c. Store the rear parcel shelf finisher in a safe location to prevent damage.



Rear Parcel Shelf
Finisher

Figure 2

8. Remove the back door upper finisher.
 - a. Apply protective tape (A) to the back door side finishers to prevent damage (Figure 3).
 - b. Release the back door upper finisher fixing clips and pawls with a suitable tool, and then remove the back door upper finisher (Figure 4).

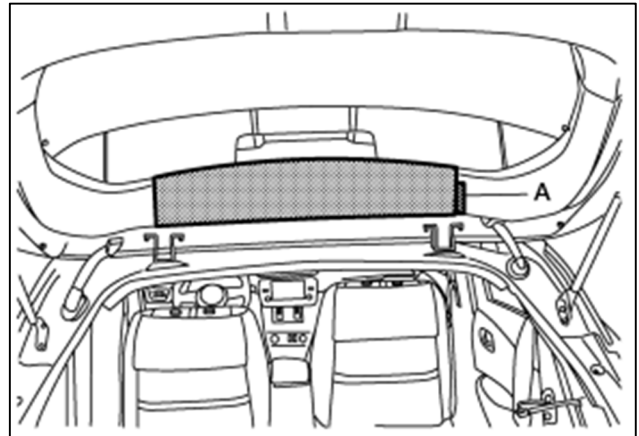

Figure 3

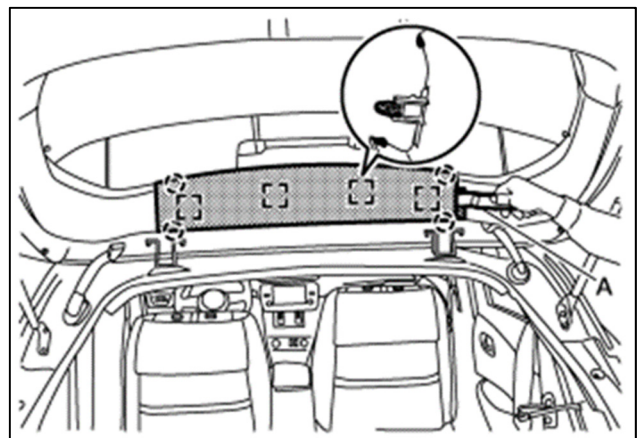

Figure 4

9. Remove both back door side finishers.
 - Release back door side finisher clips and pawl, then remove back door side finisher.

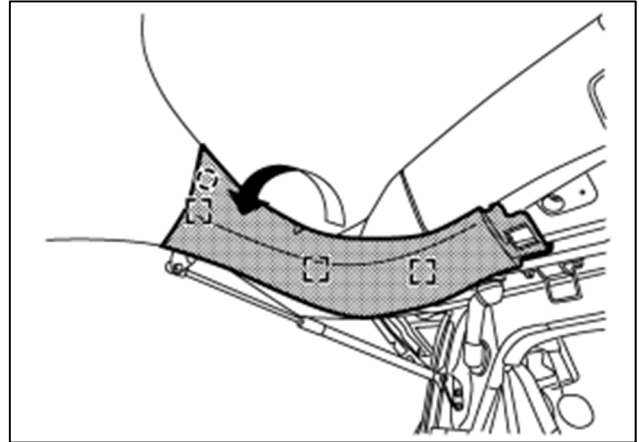

Figure 5

10. Remove the rear door pull handle (Figure 6 and Figure 7).
 - a. Apply protective tape (A) on the parts to protect them from damage.
 - b. Release back door pull handle fixing pawls with a suitable tool (B), then remove the back door pull handle.

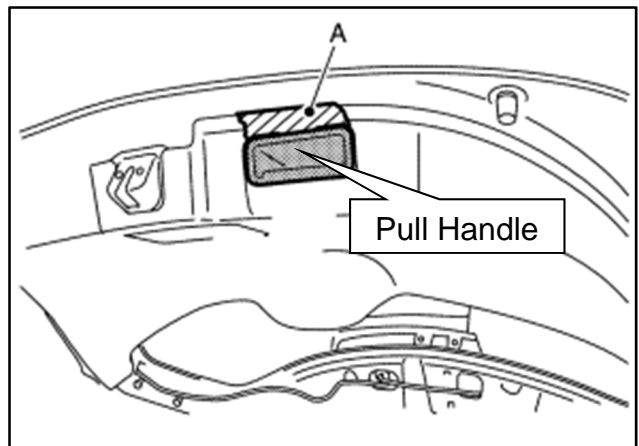

Figure 6

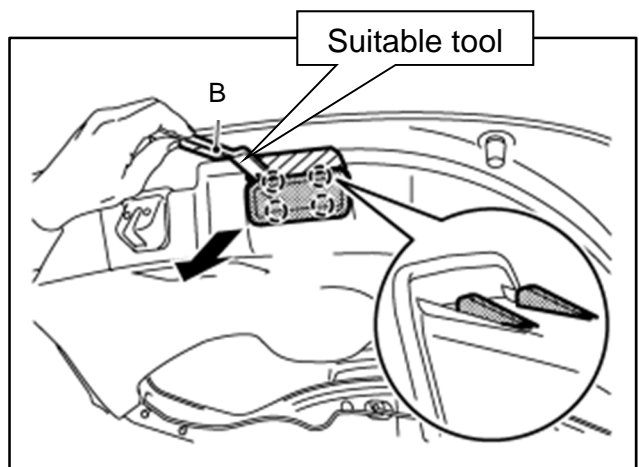

Figure 7

11. Remove the back door lower finisher.
 - a. Apply protective tape (A) on the parts to protect them from damage.
 - b. Remove the three (3) back door lower finisher clips (Figure 9).
 - c. Release the back door lower finisher clips with a suitable tool, then remove the back door lower finisher.

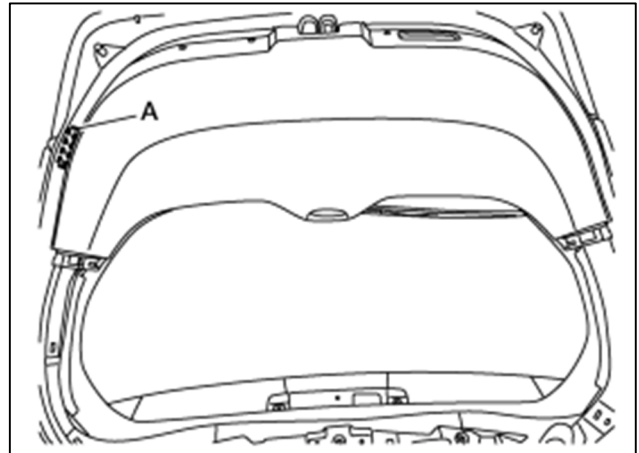

Figure 8

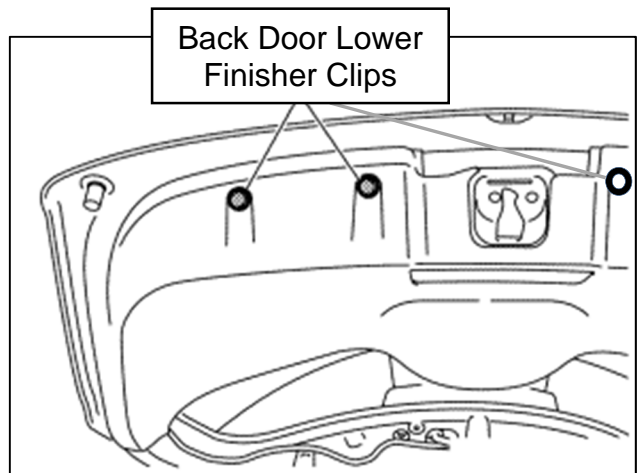

Figure 9

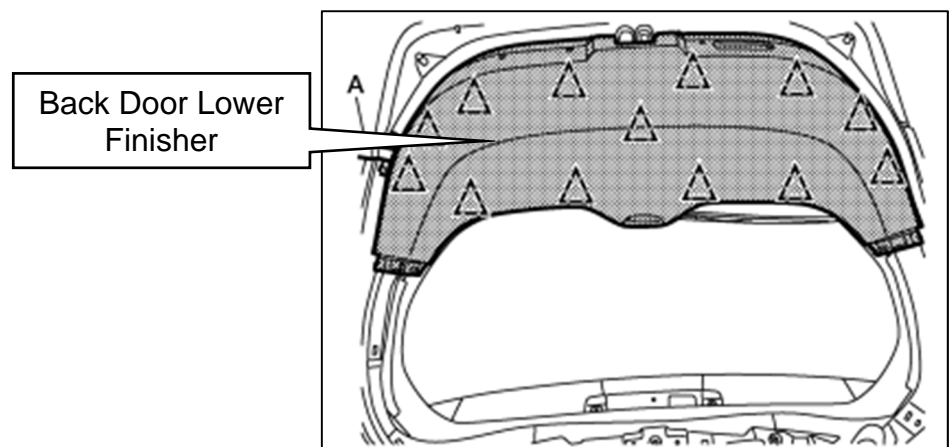

Figure 10

- 12. Remove the back door lock assembly.
 - a. Disconnect the back door lock wiring harness connector from the back door lock assembly.
 - b. Remove the two (2) 13 mm back door lock assembly retaining bolts.

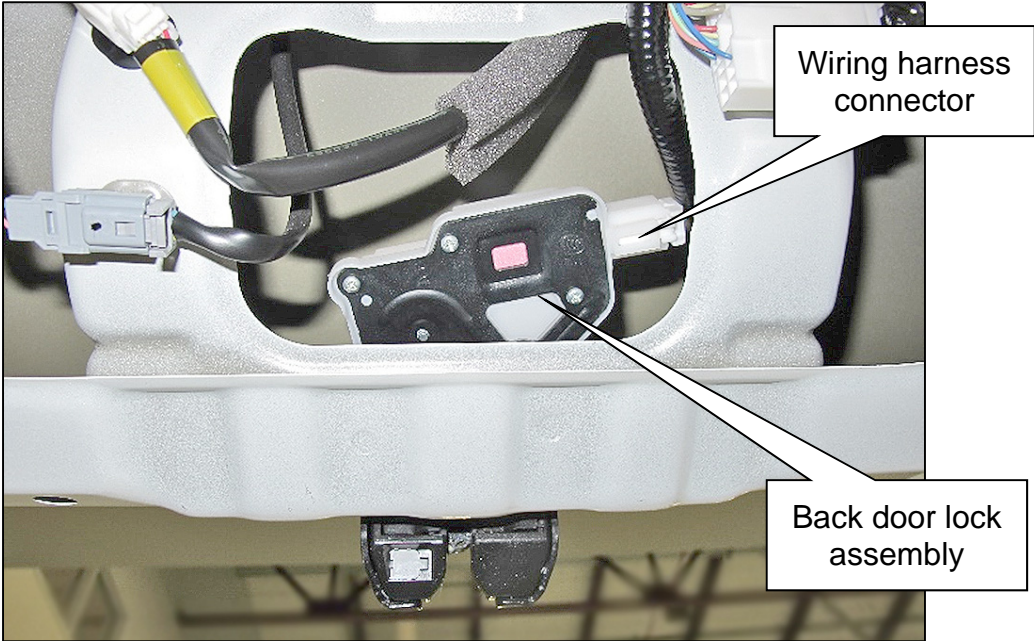

Figure 11

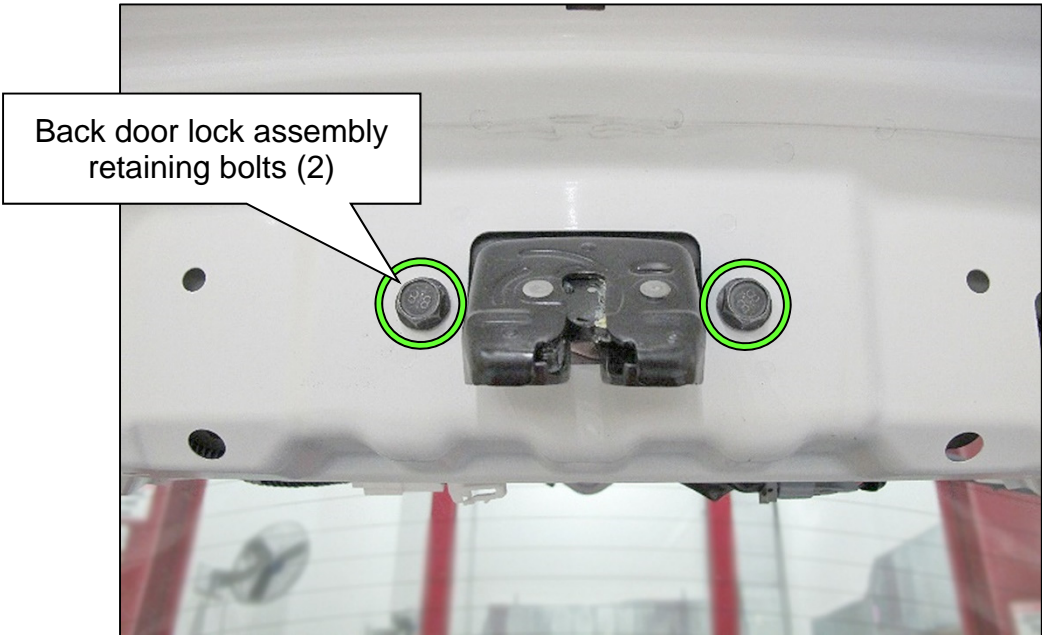

Figure 12

Foam Protector Installation

13. Cut two (2) strips of adhesive backed foam protector (PN: 24271-5RB1A) to the sizes listed below.
- Cut one strip to 20 X 40 mm.
 - Cut one strip to 30 X 80 mm.

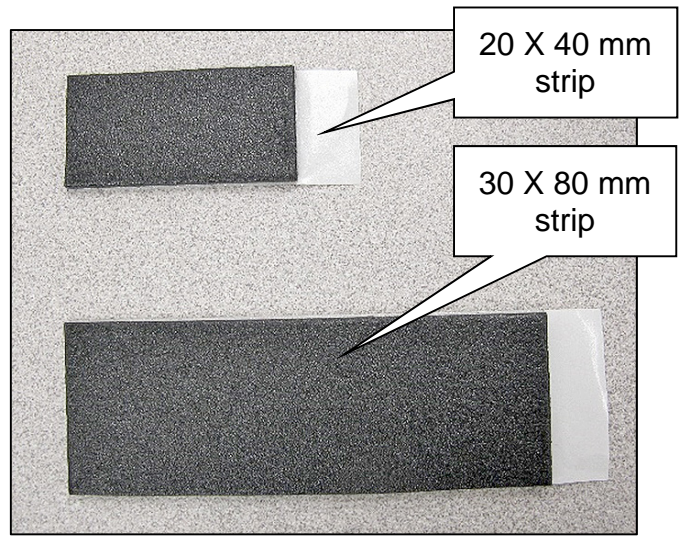

Figure 13

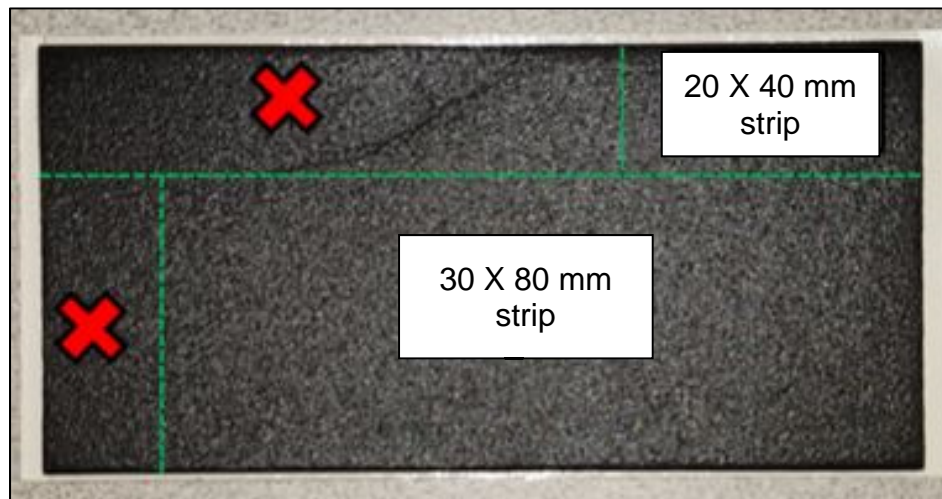
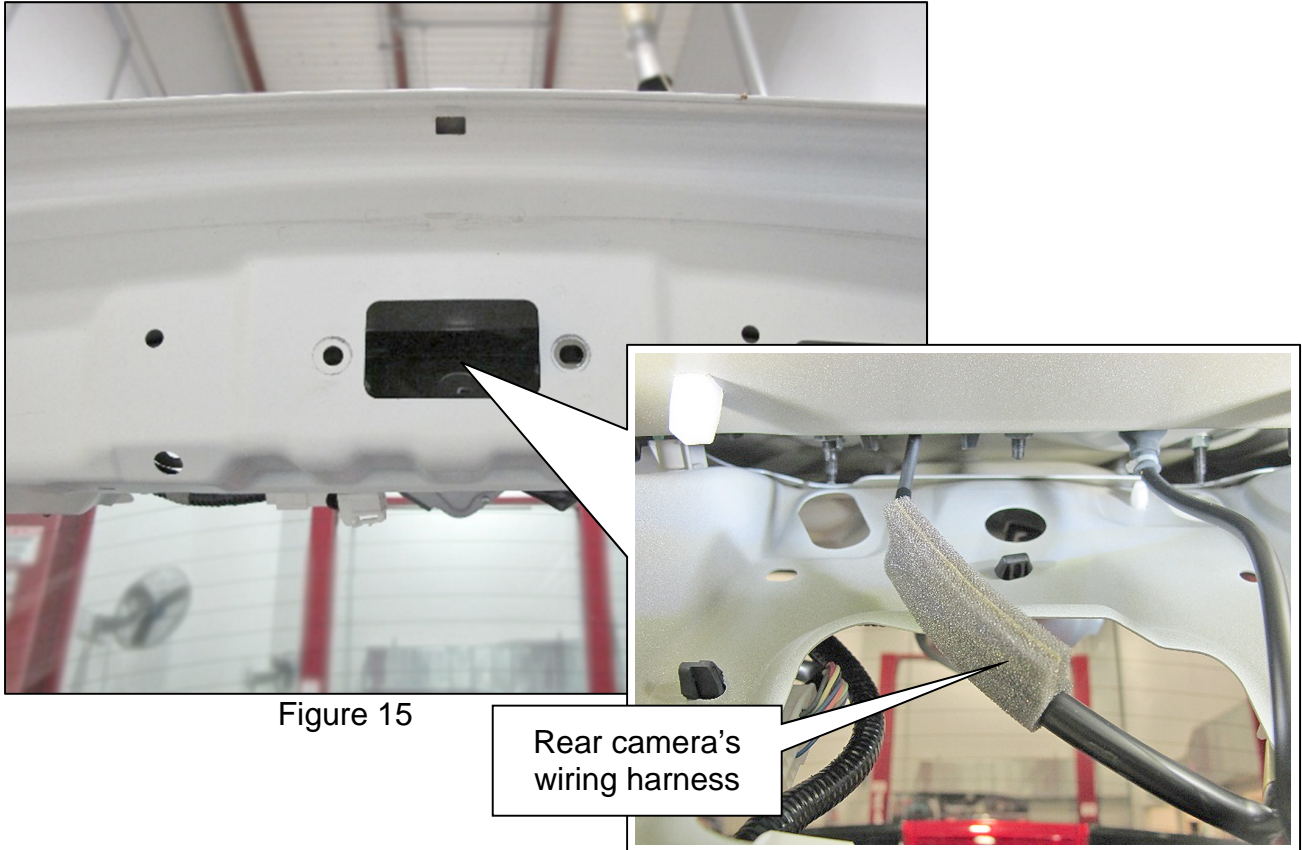

Figure 14

14. Look into the back door lock assembly hole to locate the rear camera's wiring harness.
 - Use of a light source will help with locating the rear camera's wiring harness.



15. Apply the 20 X 40 mm strip of adhesive backed foam protector to the back door opening.
 - a. Peel back the adhesive backing to reveal the foam protector adhesive.
 - b. Apply the foam protector to secure the rear camera's wiring harness to the back door opening where shown in Figure 16.

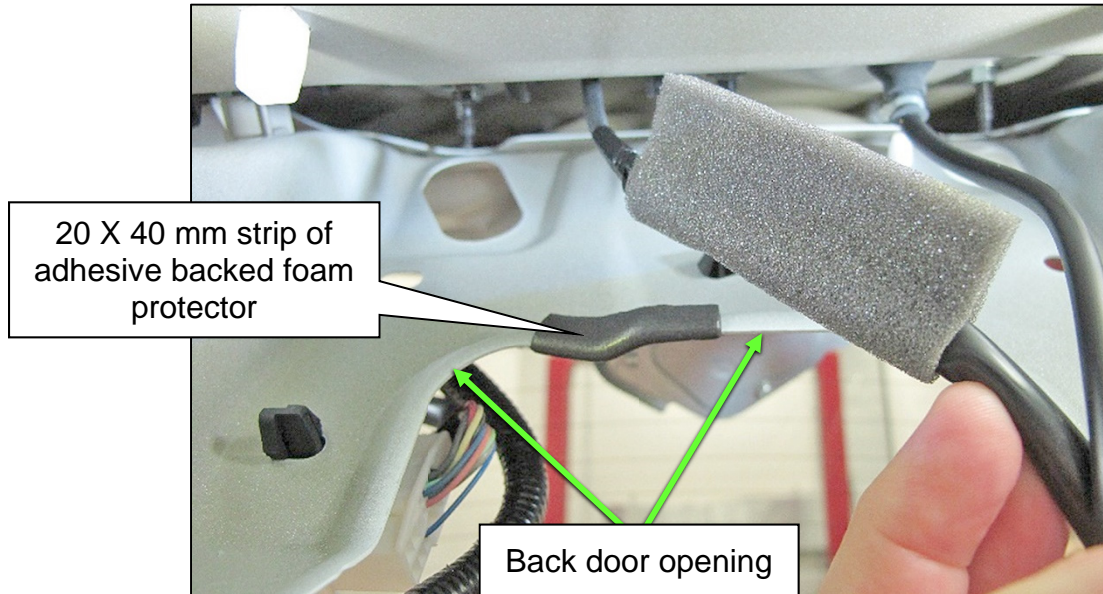

Figure 16

16. Move the camera's wiring harness downward against the inner back door panel and then secure the rear camera's wiring harness to the back door using the 30 X 80 mm strip of adhesive backed foam protector.
 - a. Peel back the adhesive backing to reveal the foam protector adhesive.
 - b. Apply the foam protector to secure the rear camera's wiring harness to the back door where shown in Figure 17.

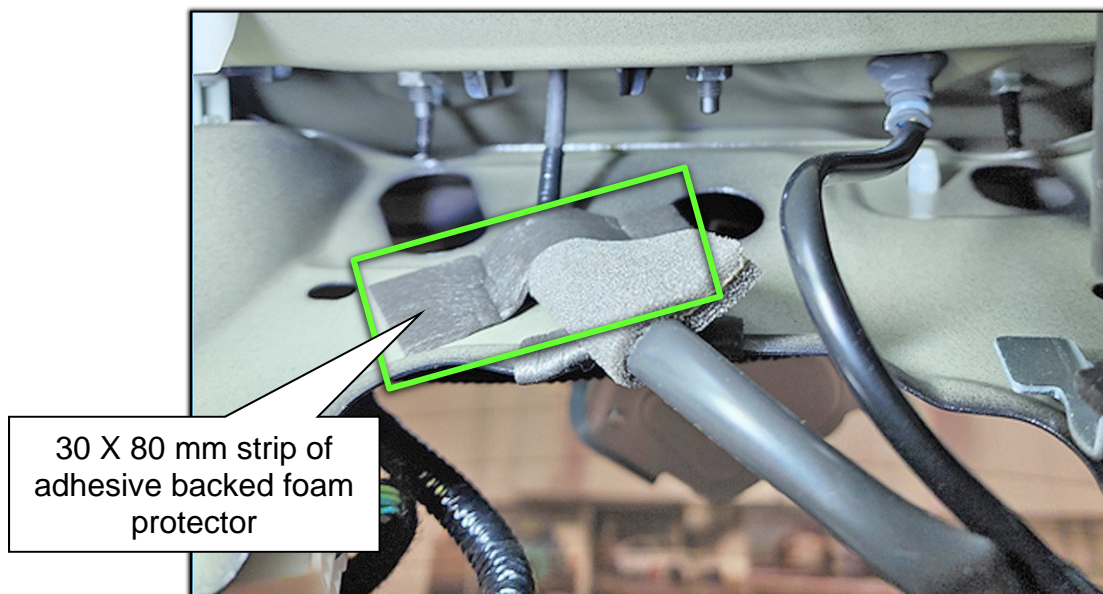

Figure 17

Reassembly And Quality Check

17. Reinstall the back door lock assembly.

HINT: When installing the back door lock assembly bolts, line them up with the witness marks on the back door shown in Figure 19.

- Torque bolts to: 13.5 N•m (1.4 kg-m, **10 ft-lb**)

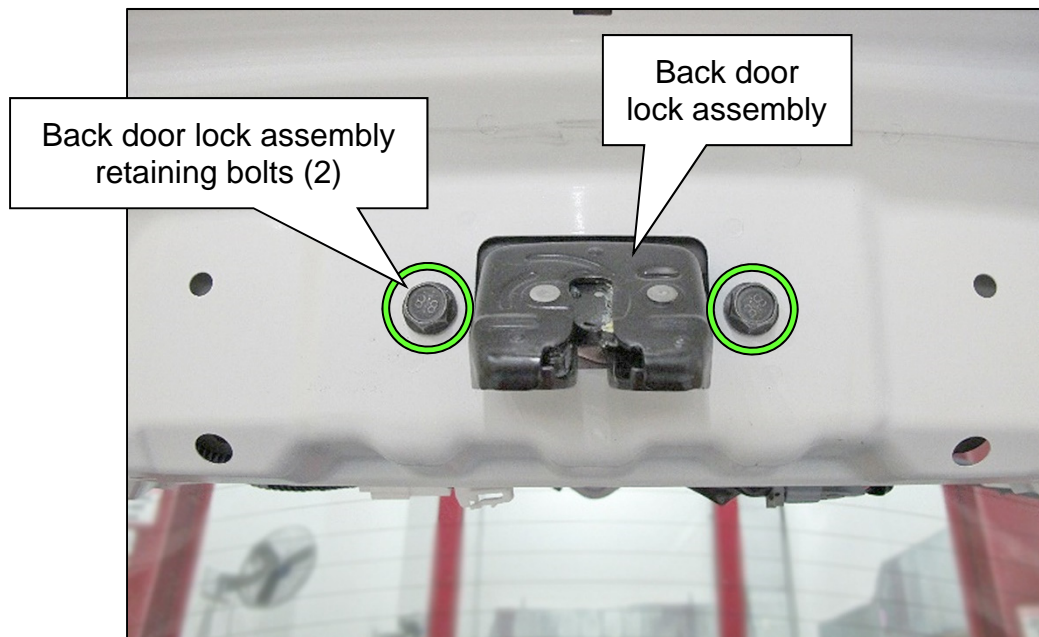

Figure 18

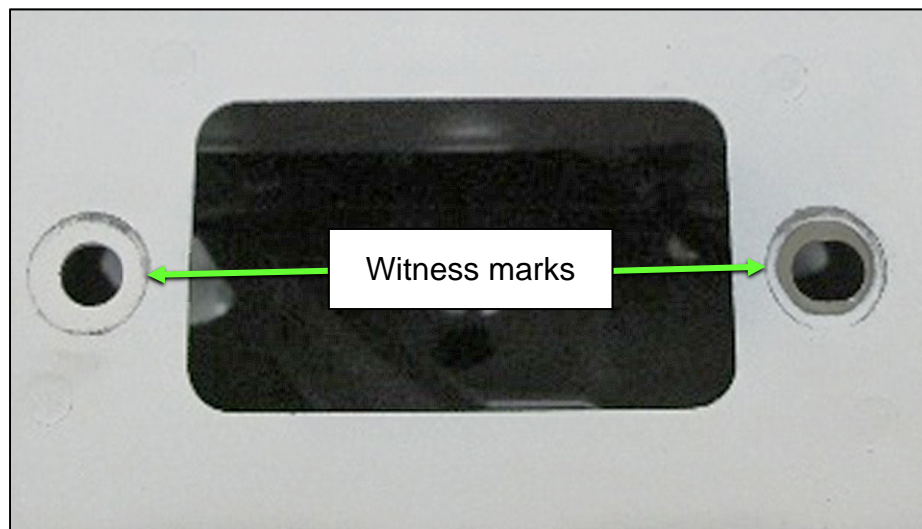

Figure 19

- Connect the back door lock wiring harness connector.

IMPORTANT: After installation of the back door lock assembly, verify the back door open/close and lock/unlock operations.

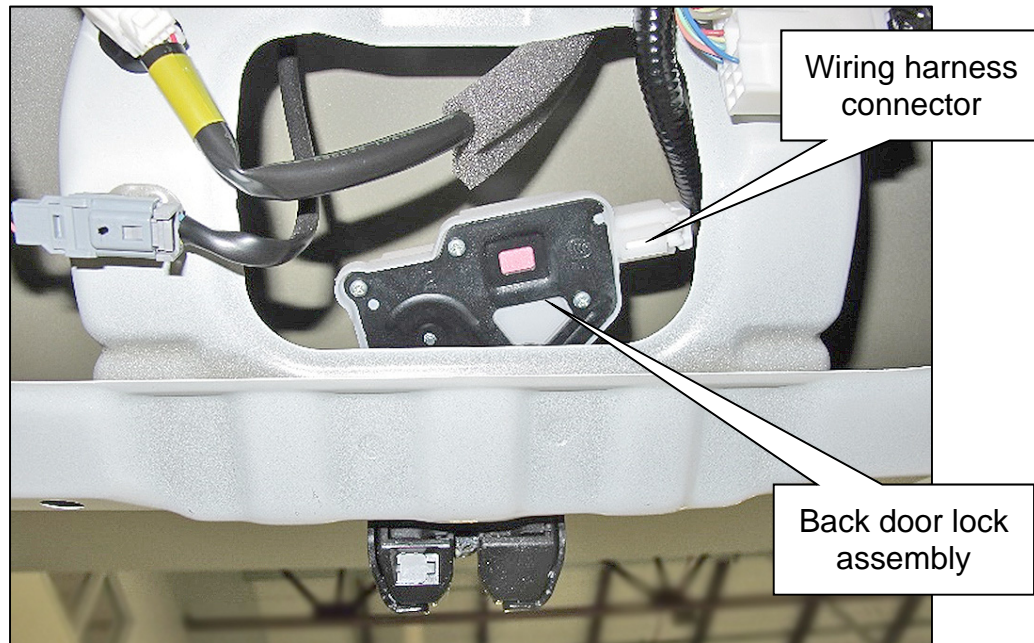

Figure 20

18. Reinstall the back door finishers in the reverse order of removal.

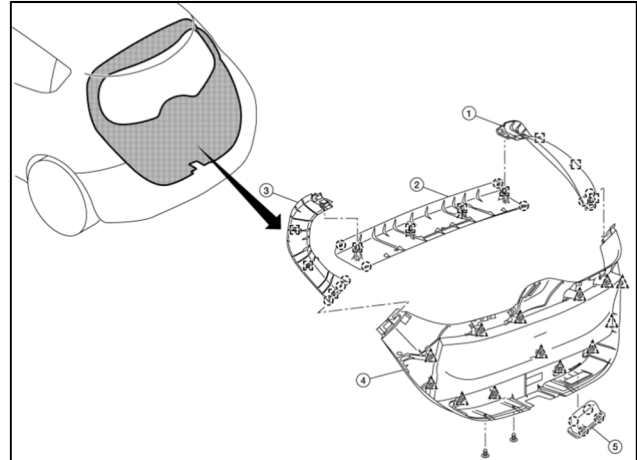

Figure 21

19. Check the rear camera operation by repeating steps 1-4 on page 3.
 - If the rear camera's image displays normally, continue to **CLAIMS INFORMATION** on the last page.
 - If the rear camera image does not display normally, replace the rear camera.
 - Refer to the ESM: **DRIVER INFORMATION & MULTIMEDIA > AUDIO, VISUAL & NAVIGATION SYSTEM > REAR VIEW MONITOR SYSTEM > WITH NAVIGATION SYSTEM > REMOVAL AND INSTALLATION > REAR CAMERA: Removal & Installation**

20. Reinstall the rear parcel shelf finisher.

- Install the back of the rear parcel shelf on the finisher pins.
- Hook the straps to the back door side finishers (Figure 23 and Figure 24).

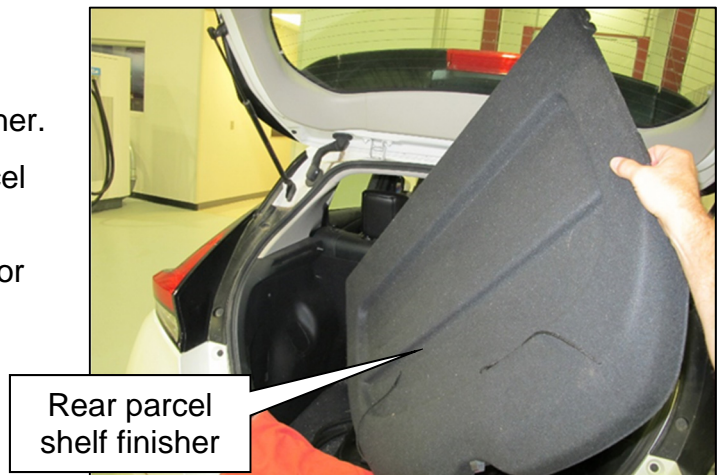

Figure 22



Figure 23



Figure 24

21. Remove fender cover and close the back door.

PARTS INFORMATION

DESCRIPTION	PART NUMBER	QUANTITY
CAMERA ASSY-BACK	28442-***** (1)	1 (2)
PROTECTOR-HARNESS	24271-5RB1A	1

- (1) Use the VIN of the vehicle being worked on and the EPC to obtain the correct part number.
- (2) Only replace the rear camera assembly if the camera image does not display normally.

CLAIMS INFORMATION

Submit a "CM" line claim using the following claims coding:

CAMPAIGN ("CM") ID	DESCRIPTION	OP CODE	FRT
R23D7	Inspect Rear Camera Operation and Add Harness Protector (OK Condition)	R23D70	0.4
	Inspect Rear Camera Operation and Replace Rear Camera	R23D71	0.8

AMENDMENT HISTORY

PUBLISHED DATE	REFERENCE	DESCRIPTION
July 3, 2024	NTB24-034	Original bulletin published
October 9, 2024	NTB24-034A	Updated step 13, Figure 14, and PARTS INFORMATION , removed EXPENSE CODE

