



## Technical Service Bulletin

<b>GROUP</b>	<b>NUMBER</b>
<b>RECALL</b>	<b>24-01-024G</b>
<b>DATE</b>	<b>MODEL(S)</b>
<b>MARCH 2024</b>	<b>GV60 (JW1 EV)</b>

**SUBJECT:** INNER SHAFT REPLACEMENT  
(RECALL 017G)

### \* IMPORTANT

Vehicle repairs related to safety recalls are critically important and must be performed properly in accordance with TSB procedures. Review this bulletin in its entirety prior to beginning any repair work.

As required by federal law, retailers must not deliver new vehicles for sale or for lease to guests until all open recalls have been performed. Retailers must also perform all open recalls on used vehicles, demo, and rental vehicles prior to placing them into guest use and whenever an affected vehicle is in the shop for any maintenance or repair.

Access the "Vehicle Information" screen via WebDCS to identify open recalls.

**Description:** Certain 2023MY GV60 (JW1 EV) may contain rear inner shafts that could fracture due to improper heat treatment. A fractured inner shaft may result in a loss of motive power while driving, increasing the risk of injury in a crash or impact. Follow the procedures in this TSB to replace the inner shaft.

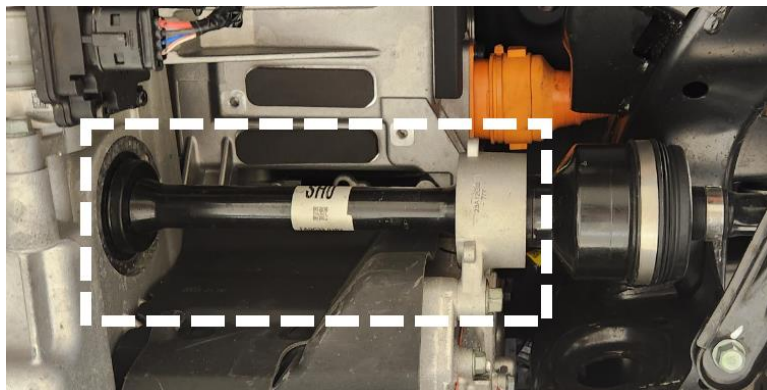

### Applicable Vehicles (Certain):



- 2023MY GV60 (JW1 EV) produced from 02/03/2023 - 03/25/2023

### NOTICE

To avoid potential damage to Genesis EVs, Genesis EV repairs can only be performed by EV certified Genesis retailers.

Circulate To: General Manager, Service Manager, Parts Manager, Warranty Manager, Service Advisors, Technicians, Body Shop Manager, Fleet Repair

**Parts Information:**

Model	Part Name	Part Number	Figure	Remarks
GV60 (JW1 EV)	Inner shaft (Bearing Bracket & Shaft Assembly)	49560- CU000QQH		Circlip included 

**Warranty Information:**

Model	Op. Code	Operation	Op. Time	Causal Part	Nature Code	Cause Code
GV60 (JW1 EV)	41D023R0	Inner Shaft Replacement	1.0 M/H	49560-CU000	D32	ZZ4

**NOTE 1:** Submit claim on Claim Entry Screen as “Campaign” type.

**NOTE 2:** If a part is found in need of replacement while performing this recall and the affected part is still under warranty, submit a separate claim using the same repair order. If the affected part is out of warranty, submit a Prior Approval request for goodwill consideration prior to performing the work.

**NOTE 3:** This TSB includes Repair validation photos. Op times include VIN, Mileage, and Repair validation photo(s) as outlined in the Digital Documentation Policy.

**NOTE 4:** The incident parts are subject to callback through the normal Warranty Technical Center (WTC) parts return process. **Claim is subject to debit if the part is not returned.**

**Service Procedure:**

**STUI**



This TSB includes Repair validation photos. Refer to the latest Warranty Digital Documentation Policy for requirements.

**i Information**

Refer to the QR code or link below for guided video information:

<https://vimeo.com/924744661/d7fe8cc51f>



**Inner Shaft Replacement**

1. Disable the Electronic Parking Brake (EPB) with the GDS tablet by selecting:

**S/W Management >  
ABS/ESP > Brake Pad Change Mode**

Follow the instructions on the GDS tablet.

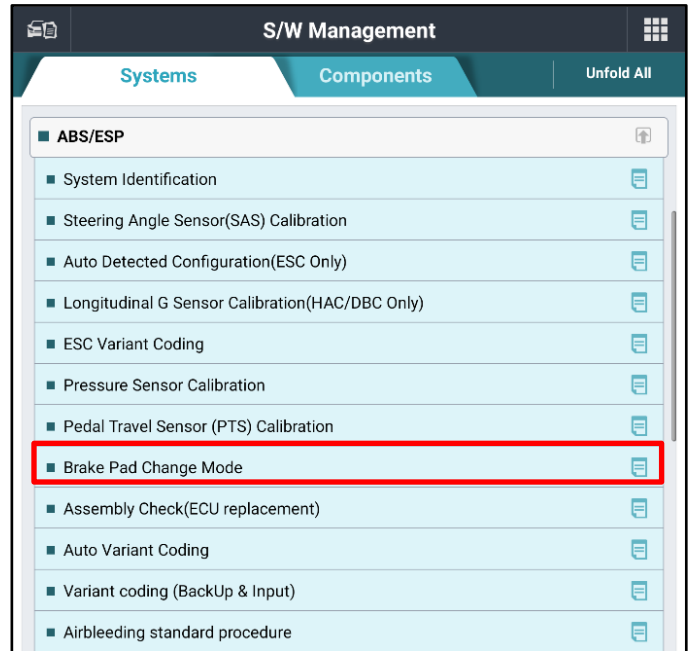

2. Disconnect the 12V battery positive (+) terminal (A).

**Tightening Torque – Battery Cable:**

<b>lb-ft</b>	6.5
<b>N.m</b>	8.8

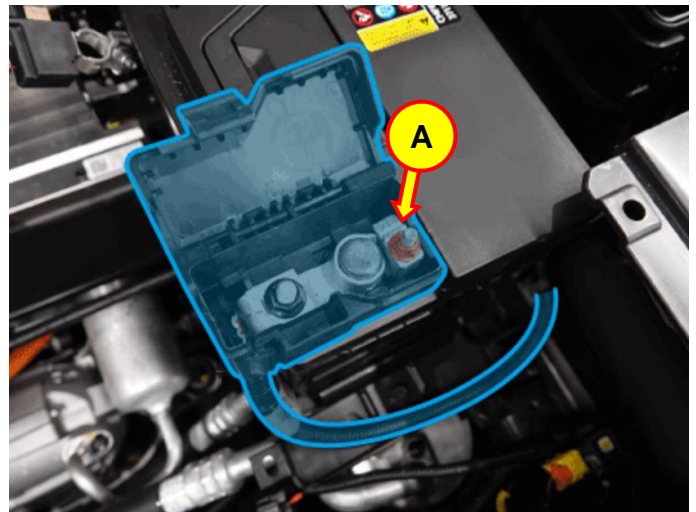

3. Remove driver's side rear wheel.

**Tightening Torque – Lug Bolts:**

<b>lb-ft</b>	109
<b>N.m</b>	147



4. Remove the rear under cover (B).

**Tightening Torque – Under Cover Nuts/Bolts:**

lb-ft	7.3
N.m	9.8

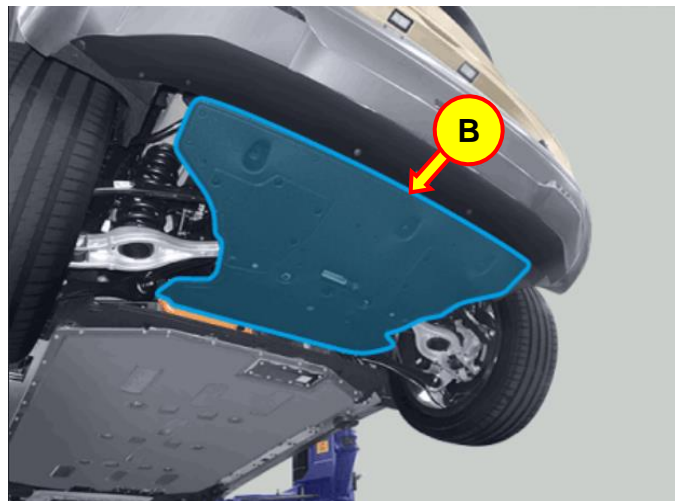

5. Use a jack to support the suspension arm assembly (C).

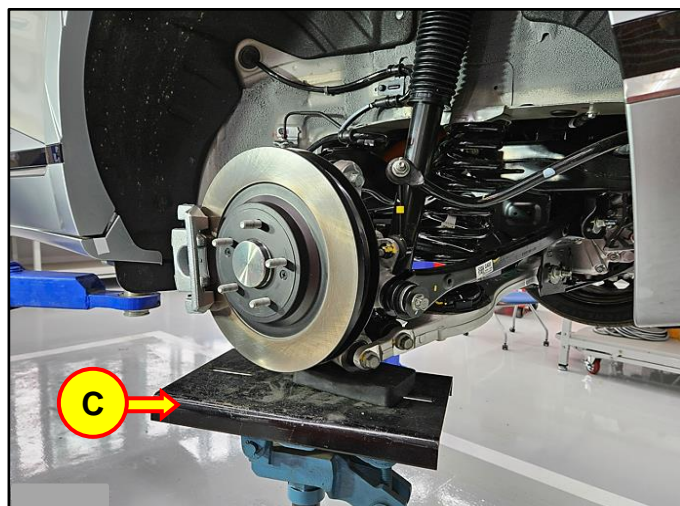

6. Disconnect the EPB actuator connector (D).

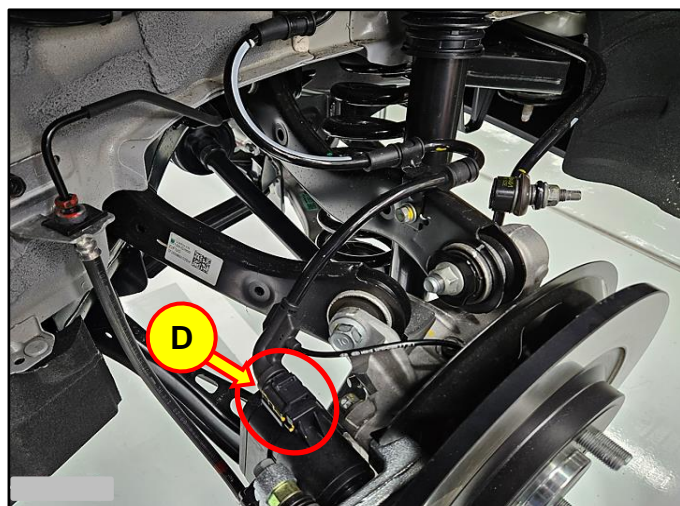



7. Remove the bolts to remove the wheel speed sensor (E) from the carrier and the wheel speed sensor harness bracket (F).

**Tightening Torque – Wheel Speed Sensor Bolt:**

lb-ft	8.3
-------	-----

N.m	11
-----	----

**Tightening Torque – Wheel Speed Sensor Harness Bracket Bolt:**

lb-ft	11
-------	----

N.m	15
-----	----

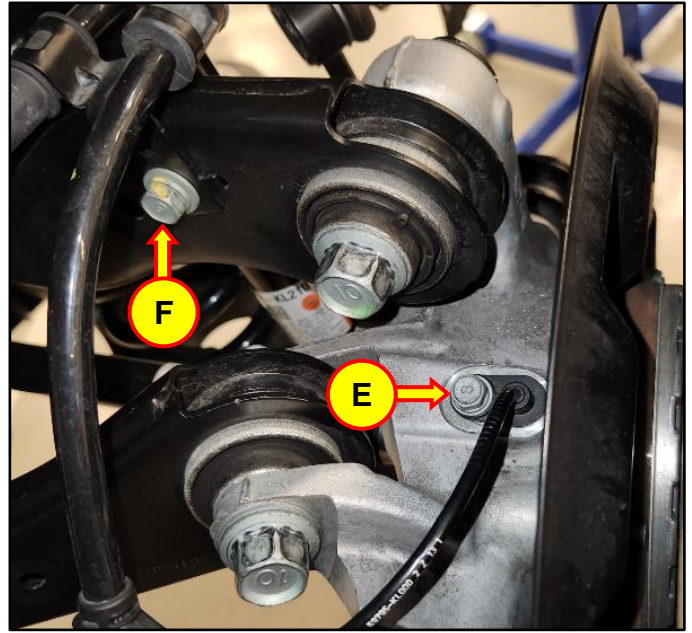

- Remove bolts (G) to remove the brake caliper assembly from the carrier.

**Tightening Torque – Caliper Carrier Mounting Bolts:**

lb-ft	80
N.m	108

**NOTICE**

Secure the brake caliper. Do **NOT** suspend the brake caliper by the brake hose.

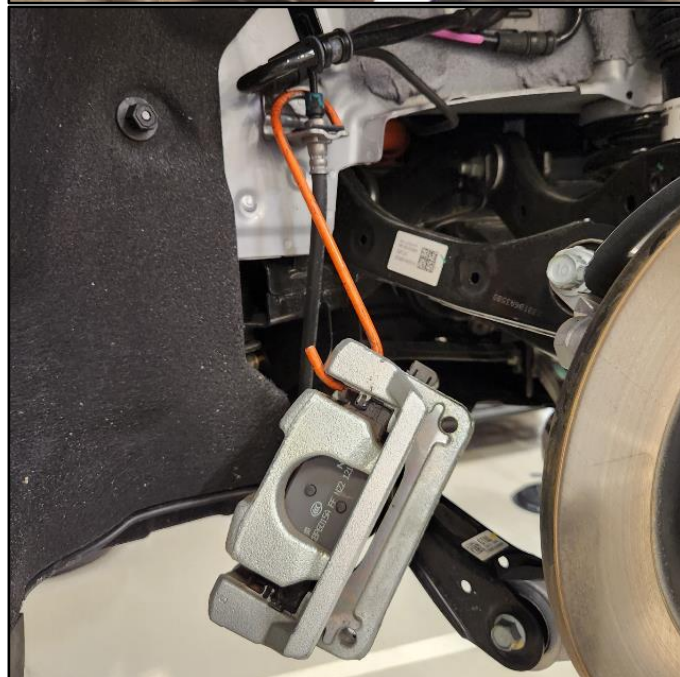
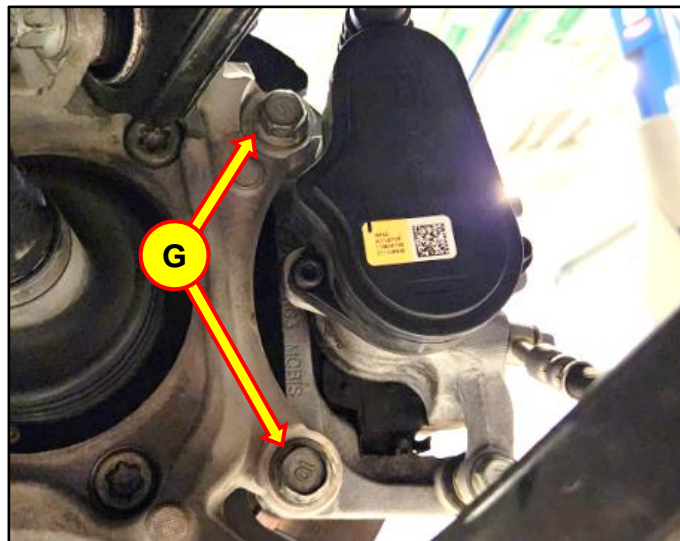

**i Information**

Do not touch the alignment setting cam bolts (H) for the rear suspension during the repair.

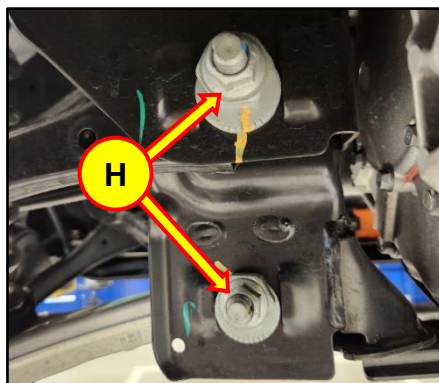

9. Remove the bolt (I) to remove the assist arm from the carrier.

**Tightening Torque – Assist Arm Bolt:**

lb-ft	95
N.m	128

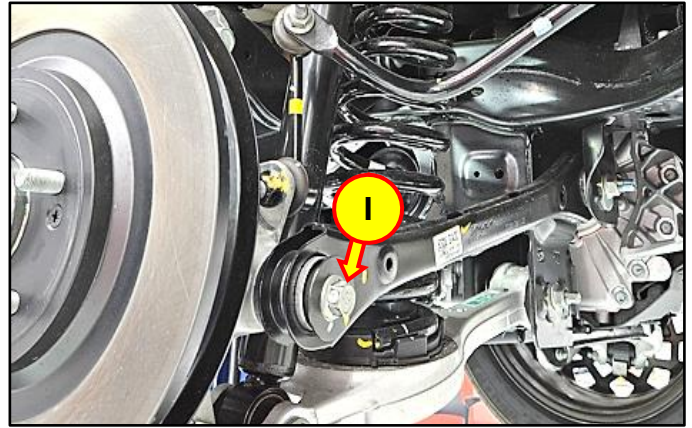

10. Remove the shock absorber assembly from the vehicle.

Remove the bolts (J) to remove the upper shock insulator from the body.

**Tightening Torque – Upper Strut Insulator to Body Bolts:**

lb-ft	42
N.m	57

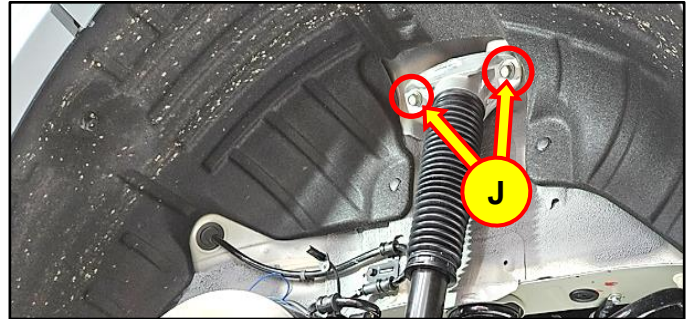

Remove the bolt (K) to remove the shock from the lower control arm.

**Tightening Torque – Lower Shock Bolt to Lower Control Arm:**

lb-ft	138
N.m	186

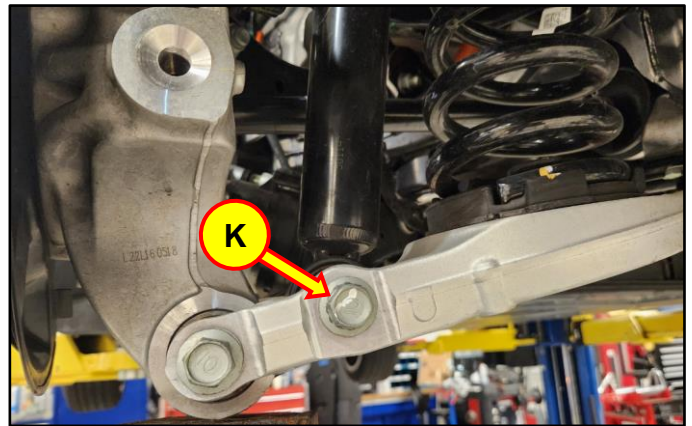

11. Remove the two bolts (L) to remove the upper arms from the carrier.

**Tightening Torque – Upper Arm Bolts:**

lb-ft	123
N.m	167

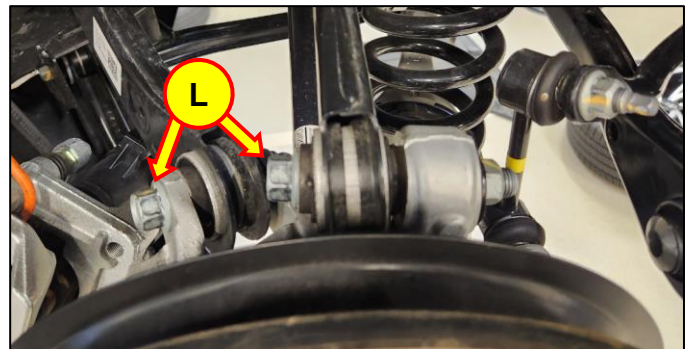



13. Remove the nut (M) to separate the stabilizer linkage and stabilizer bar.

**Tightening Torque – Stabilizer Linkage Nut:**

lb-ft	80
N.m	108

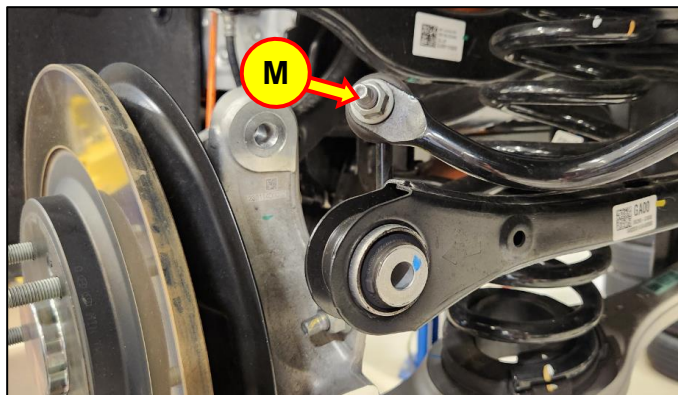

14. Remove the Integrated Drive Axle (IDA) from the inner shaft using a rubber or wood block (N) and rubber mallet as shown to the right.

**NOTICE**

Do **NOT** use metallic tools to remove the IDA.

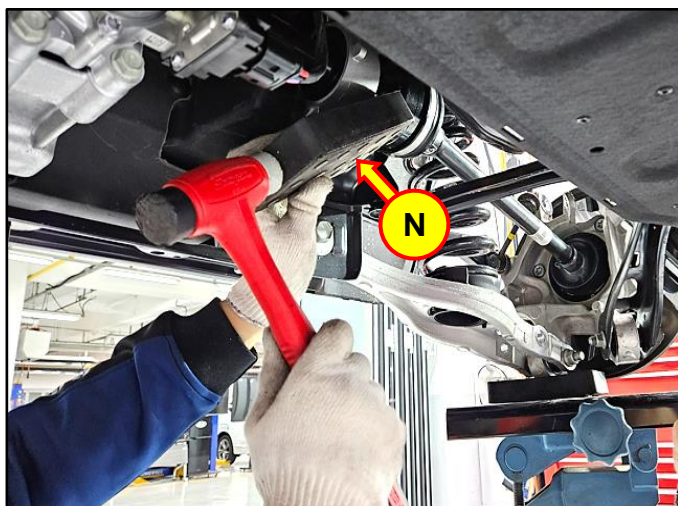

15. Remove the bolts (O) to remove the old inner shaft.

**Inner Shaft Bracket Tightening Torque:**

lb-ft	50
N.m	67

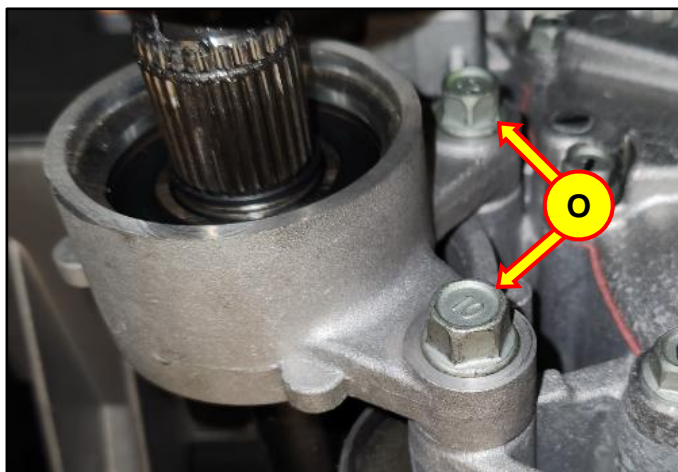



16.

**STUI**

Using STUI, take a photo of the new QQH inner shaft on the parts box with the part number (P) clearly visible, the original removed inner shaft next to the box, and the last 6 digits of the VIN and the date of repair on a piece of paper.

Upload the photo to STUI.



17. Install the new inner shaft.

**i Information**

Ensure the new inner shaft is equipped with a circlip (Q).

Do **NOT** reuse the circlip from the removed inner shaft.

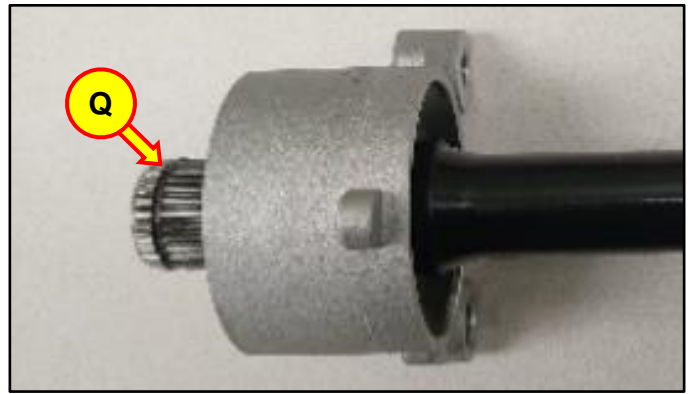

18. After installing the new inner shaft, ensure that the IDA is properly installed.

The IDA joint cup (T) should not slide back and forth on the inner shaft. The inner shaft circlip should securely retain the IDA joint cup.

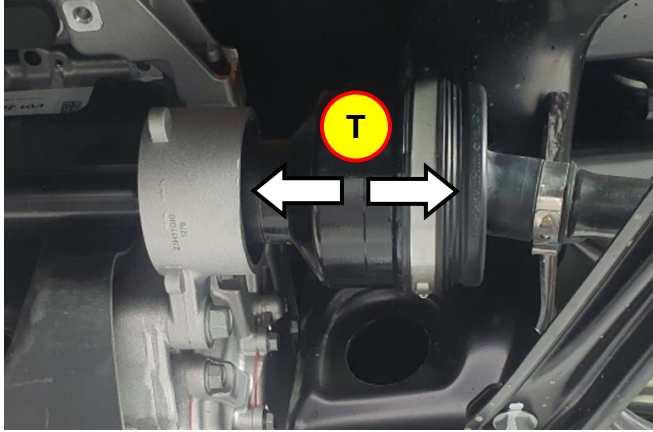

**GOOD:** IDA dust cover (R) is fully inserted into the inner shaft bracket (S).

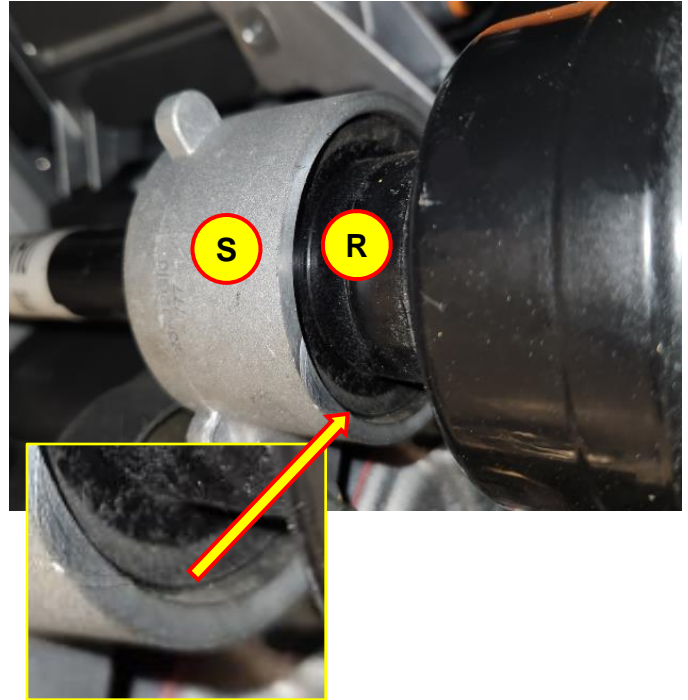

**NOT GOOD:** A gap remains between the IDA dust cover and inner shaft bracket.

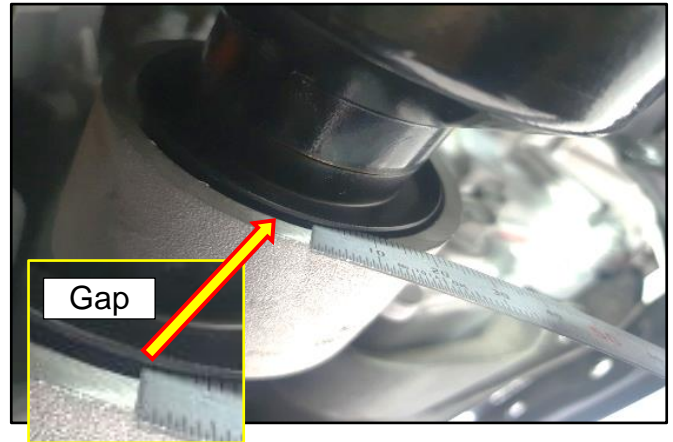

19. Reinstall parts in the reverse order of the removal.

***i* Information**

Wheel alignment is **NOT** necessary after replacing the inner shaft.

20. Enable the EPB with the GDS tablet by selecting:

**S/W Management > ABS/ESP > Brake Pad Change Mode**

Follow the instructions on the GDS tablet.

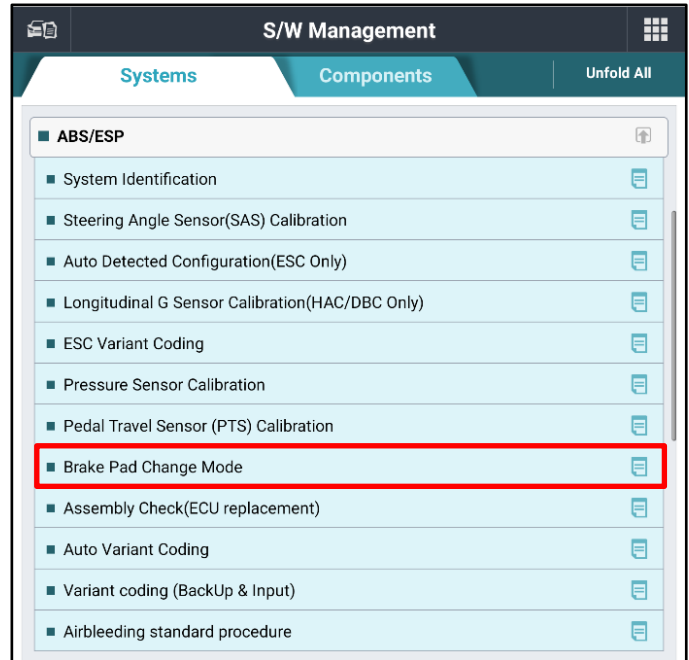

The procedure is now complete.