



GROUP	MODEL
Safety Recall Campaign	2023-2024MY Sportage (NQ5a) and 2022-2024MY Carnival (KA4) without Roof Rails
NUMBER	DATE
SC292	March 2024

SAFETY RECALL CAMPAIGN

ROOF MOLDING INSPECTION, RETENTION AND REPLACEMENT (SC292)

SUBJECT:

This bulletin provides information to inspect and, if necessary, secure or replace the roof molding on certain 2023-2024 Sportage (NQ5a) vehicles produced from January 12, 2022 through November 29, 2023, and certain 2022-2024 Carnival (KA4) vehicles (not equipped with roof rails) produced from January 5, 2021 through November 24, 2023. The roof molding may become loose or detach under certain circumstances either due to interference of the roof molding retaining clip(s) with excessive roof panel sealer or due to improper installation of the roof molding during vehicle assembly. A detached roof molding can create a road hazard for other vehicles, increasing the risk of a crash. Follow the procedure, outlined in this publication to inspect the roof moldings, and if necessary, secure the affected molding or replace and secure it with a new part. Before conducting the procedure, verify that the vehicle is included in the list of affected VINs.

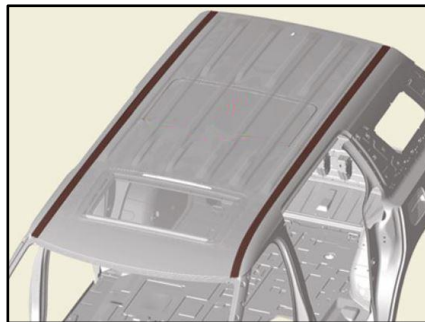

NOTICE

There is no charge to the vehicle owner for this repair. Under applicable law, you may not sell or otherwise deliver any affected vehicle until it has been repaired pursuant to the procedures set forth in this bulletin.

Repair status for a VIN is provided on KDealer+ (Service → Warranty Coverage → Warranty Coverage Inquiry → Campaign Information). Not completed Recall / Service Action reports are available on KDealer+ (Consumer Affairs → Not Completed Recall → Recall VIN → Select Report), which includes a list of affected vehicles.

A printed copy is for reference only; publication information can be updated at any time. Always refer to KGIS for the latest information. After logging in kdealer.com, the newest technical publications are listed in 'Service Releases' and has the latest service information that has been released.

Inspection Procedure:

Loose Molding 1



Loose Molding 2

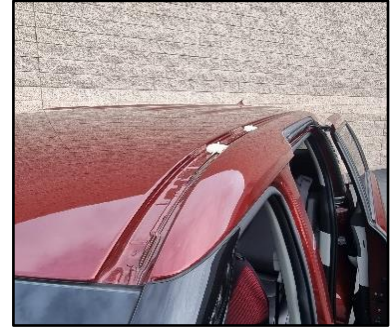

Missing Molding

1. Inspect the front area of both the left and right side roof moldings in the area shown. The molding should be flush with the roof body and secured at the front molding windshield area.

- If the molding is secured normally **(OK)** take a KVID video starting from the VIN label and show the secured **(OK)** roof molding(s), then proceed to the 'Repair Procedure' on page 3 to secure the existing roof molding.
- If the roof molding is not secured and/or is found to be loose/detached **(NG)**, take a KVID video starting from the VIN label and show the loose/detached **(NG)** roof molding(s) and proceed to the 'Replacement Procedure' on page 5 and replace the affected roof molding (left, or right, or both).
- If the roof molding is missing **(NG)**, take a KVID video starting from the VIN label and show the missing **(NG)** roof molding(s) and proceed to the 'Replacement Procedure' on page 5 to replace the affected roof molding (left, or right, or both).

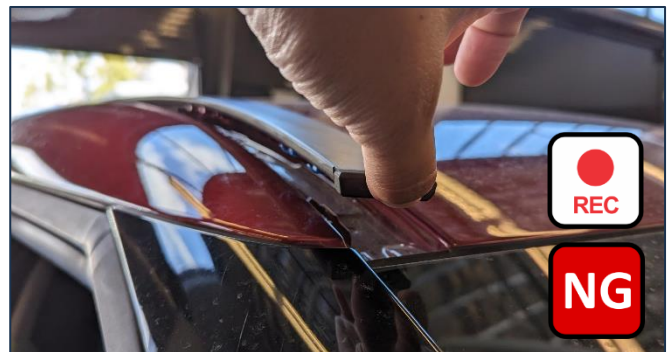
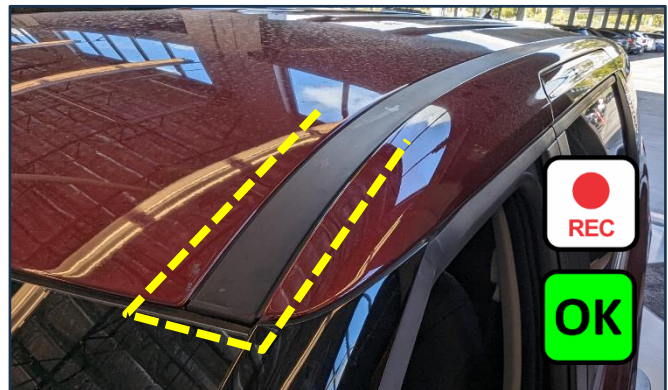

Note: Use very 'light' upward pressure to verify if the roof molding is not secured/loose/detached. Do not try to forcefully pry up the roof molding.



SUBJECT: ROOF MOLDING INSPECTION, RETENTION AND REPLACEMENT (SC292)

Repair Procedure: (Sealant Application, ALL applications)

- 1a. **Carnival (KA4):** Using a non-marring trim removal tool, lift the front of the roof molding by detaching only the first three (3) clips.

Sportage (NQ5a): Using a non-marring trim removal tool, lift the front of the roof molding by detaching only the first two (2) clips.

! CAUTION

Use a non-marring trim removal tool (such as Snap-on® Part Number PBN5 or equivalent) to avoid damaging trim pieces. **DO NOT** bend, twist, or scratch the molding(s). Place a soft cloth on the vehicles body as to not damage the paint.



- 1b. Place the trim removal tool and/or a soft cloth between the molding and roof to prop up the molding.



- 2a. **Carnival (KA4) ONLY:** Using diagonal cutting pliers, cut-off the two (2) supporting legs (A) from the 1st. **yellow** roof molding clip only.

Note: The roof molding clips are **yellow** and **teal** in color, DO NOT cut-off the 2nd. **teal** clip.

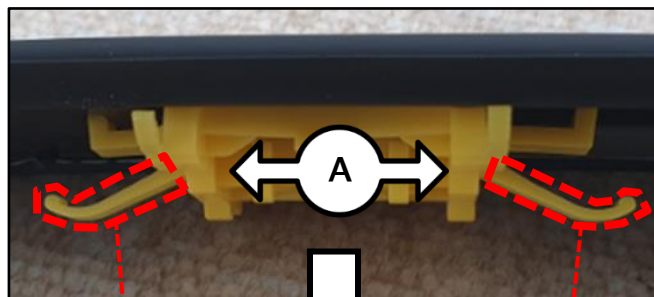

- 2b. **Sportage (NQ5a):** DO NOT cut-off any clips.

- 2c. Proceed to step 3.

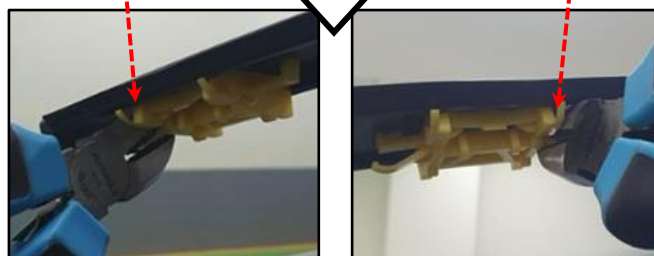

Roof moldings removed for illustration purposes only.

SUBJECT: **ROOF MOLDING INSPECTION, RETENTION AND REPLACEMENT (SC292)**

3. Apply a 10mm thick bead of body seam sealant (PN UM024 CH276) to the first and second clip mounting area of the roof, as shown.

Note: Thoroughly clean and dry the roof surface area and clips from moisture/dirt, to ensure sealant properly adheres to the molding and roof.



Note: Image shown for illustration purposes.
The sealant used will be clear.

4. Reattach the roof molding (A) by putting downward pressure until a 'click' sound is heard, ensuring the clips are secured.

ⓘ IMPORTANT

Ensure the roof molding is properly installed. There should be no gap between the molding and the windshield.

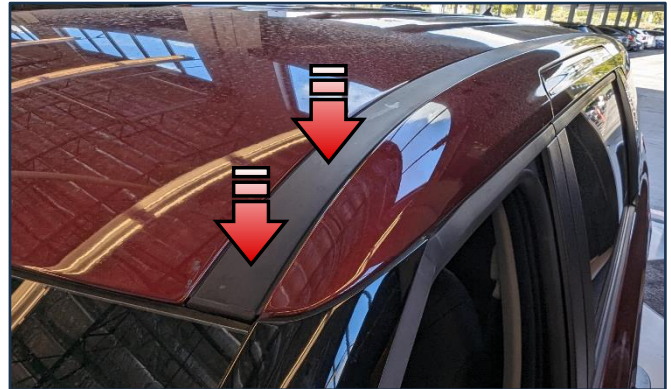

5. Repeat steps 1 - 4 for the opposite side (if applicable).



Replacement Procedure: (For Missing NG Roof Molding)

IMPORTANT: BEFORE INSTALLING THE NEW ROOF MOLDING

- 1a. **Sportage (NQ5a):** Refer to page 4, step 3 of the 'Repair Procedure' to apply the sealant as outlined in the instructions.
- 1b. **Carnival (KA4):** Refer to pages 3-4, steps 2-3 of the 'Repair Procedure' to apply the sealant as outlined in the instructions.
- 1c. Proceed to step 2.



Note: Image shown for illustration purposes. The sealant used will be clear.

- 2. Install the new roof molding(s) (A) by placing downward pressure until an audible 'click' sound is heard, ensuring the clips are fastened.

Note: Repeat for the opposite side (if applicable).

Sportage (NQ5a) - Seven (7) clips.



Carnival (KA4) - Eleven (11) clips.

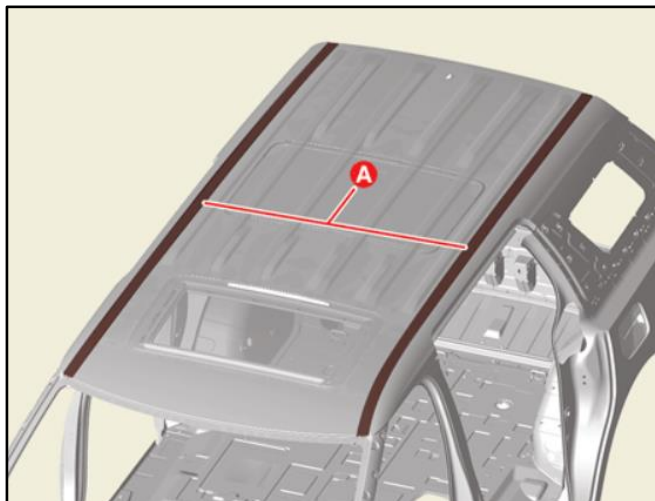

ⓘ IMPORTANT
 Ensure the roof molding is properly installed. There should be no gap between the molding and the windshield.







- 3. Confirm normal vehicle operation.

SUBJECT: ROOF MOLDING INSPECTION, RETENTION AND REPLACEMENT (SC292)

AFFECTED VEHICLE RANGE:

Model	Production Date Range
Sportage (NQ5a)	January 12, 2022 to November 29, 2023
Carnival (KA4)	January 5, 2021 to November 24, 2023

REQUIRED PART:

Model	Part Name	Part Number	Figure	Qty.	Comments
NQ5a	Roof Molding (LH)	87230 DW000QQK		1	N/A
	Roof Molding (RH)	87240 DW000QQK		1	N/A
KA4	Roof Molding (LH)	87230 R0000QQK		1	N/A
	Roof Molding (RH)	87240 R0000QQK		1	N/A
All	Sealant* 3M 730 UV Clear	UM024 CH276		0	Kia Chemicals or Locally Sourced

Note: The QQK replacement part numbers will require a VIN entry for parts ordering. DO NOT order these parts for stocking purposes, related to this Campaign. Supply is very limited. Please be sure to expedite warranty claim filing.

*Note: The sealant tube can be used for up to 10 vehicles.

SUBJECT: ROOF MOLDING INSPECTION, RETENTION AND REPLACEMENT (SC292)

WARRANTY INFORMATION:

N Code: N99 C Code: C99

Model	Claim Type	Causal P/N	Qty.	Repair Description	Labor Op Code	Op Time	Replacement P/N	Qty.
KA4	R	87230 R0000	0	(SC292) Roof Sealant Application (both sides)	241016R0	0.4 M/H	N/A	0
			0	(SC292) Roof Sealant Application + Molding Replacement (both sides)	241016R1	0.4 M/H	87230 R0000QQK and 87240 R0000QQK	2
			0	(SC292) Roof Sealant Application (one side) + Molding Replacement (one side L/R)	241016R2	0.4 M/H	87230 R0000QQK or 87240 R0000QQK	1
NQ5a	R	87230 DW000	0	(SC292) Roof Sealant Application (both sides)	241A02R0	0.4 M/H	N/A	0
			0	(SC292) Roof Sealant Application + Molding Replacement (both sides)	241A02R1	0.4 M/H	87230 DW000QQK and 87240 DW000QQK	2
			0	(SC292) Roof Sealant Application (one side) + Molding Replacement (one side L/R)	241A02R2	0.4 M/H	87230 DW000QQK or 87240 DW000QQK	1

Note: Refer to [Warranty Bulletin 2024-11](#) for claim submission procedures. Manually enter sublet code 'X2' for reimbursement of one roundtrip rideshare expense or up to three (3) days of rental expense, with supporting documentation. Use sublet 'X1' with a maximum allowed amount of \$6.00 per vehicle for sealant.

*A KVID video is required for all labor ops. Failure to provide the required KVID photo(s) will result in claim rejection or chargeback.

NOTICE

VIN inquiry data for this repair is provided for tracking purposes only. Kia retailers should reference **SC292** when accessing the KDealer+ system.

