

Recall Notice Service Bulletin 407587 Rev. A



631 West 11th Street • P.O. Box 310 • Winamac, IN 46996

(574) 946-4139 • 1-800-THE-LIFT • www.braunability.com

February 2024

Applicable for NULC65S32X60I

NHTSA Recall No.: 24E017

Read Instructions Before Beginning

Labor Time

Inspection: 1/2 Hour

Inspection and Tee Fitting Relocate: 1 Hour

Warranty Topics

Lift - Recall - 24E017 - Inspect

Lift - Recall - 24E017 - Repair

Pressure Switch Location Inspection

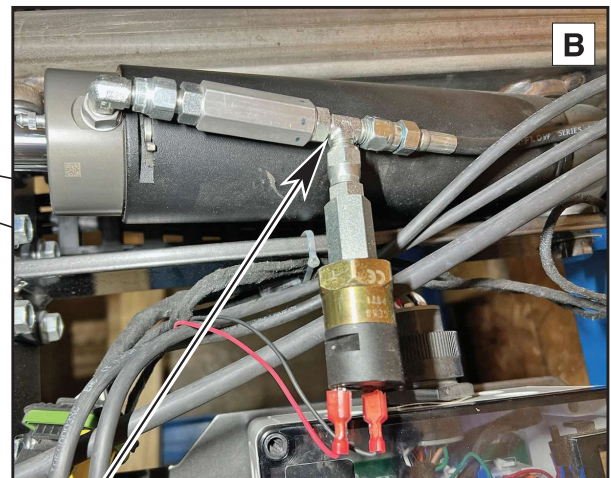
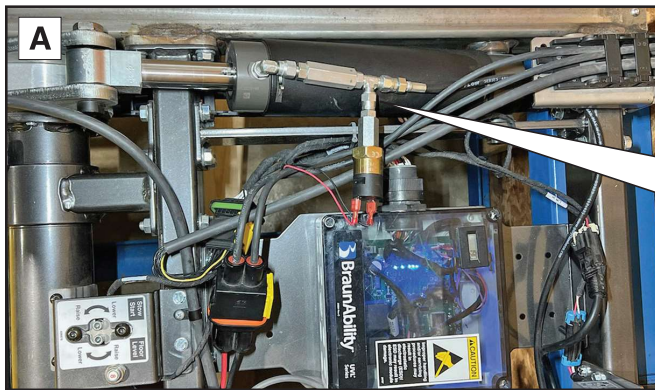

1. If lift is installed in a bus, position lift at stow level, partially deployed, leaving the pressure switch accessible through the center aisle of the bus.

Tee Fitting

Current Configuration

2. Inspect location of pressure switch tee fitting. See Photos A through C.

3. If tee fitting is at location shown in Photo C, no further action is required.
If tee fitting is at location shown in Photo B, the pressure switch relocation procedure must be performed.

If performing procedure with lift in a bus, proceed to page 2.

If performing procedure with lift on a shipping crate, proceed to page 4.

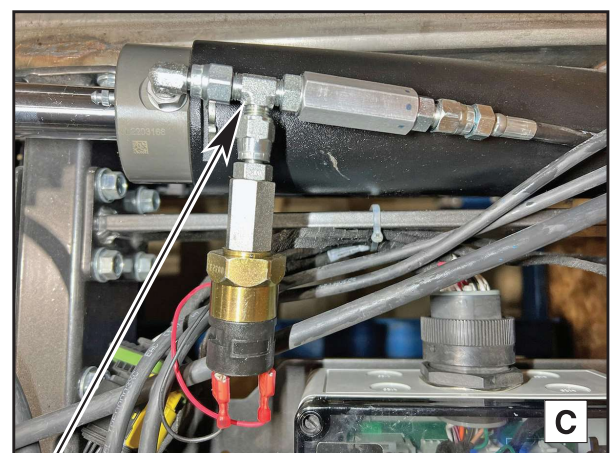

Tee Fitting

New Configuration

Pressure Switch Relocation Instructions 407587 Rev. A

Pressure Switch Relocation With Lift in Bus

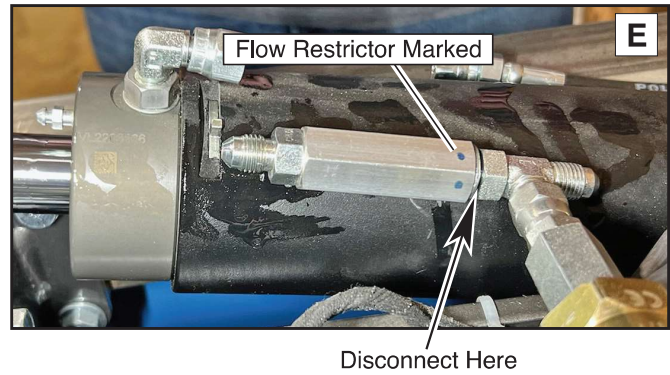
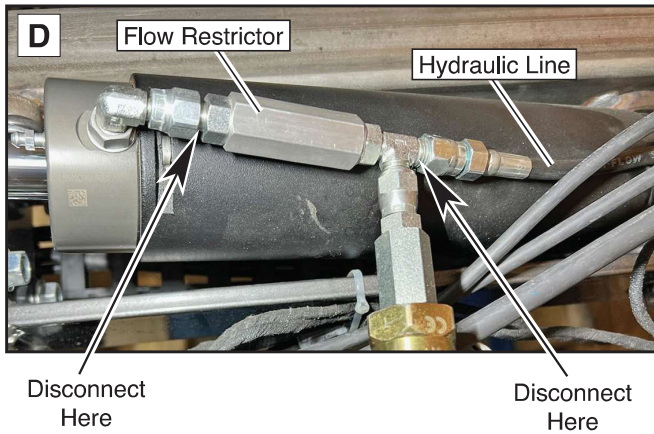

4. Open manual relief valve.

5. Remove power from lift by disconnecting the 2-pin high power connector in the carriage.

6. Unlock the chain release.

7. Disconnect hydraulic line and flow restrictor as shown. Mark the flow restrictor with a marker. See Photos D and E.

8. Disconnect flow restrictor at location indicated in Photo E and connect pressure switch to cylinder as shown in Photo F. Tighten to snug.

9. Remove fitting from flow restrictor and connect to opposite end of flow restrictor. Tighten to snug. Ensure flow restrictor is oriented in the correct direction. Arrow must be pointing toward the fitting and the marks put on flow restrictor in Step 7. See Photo G.

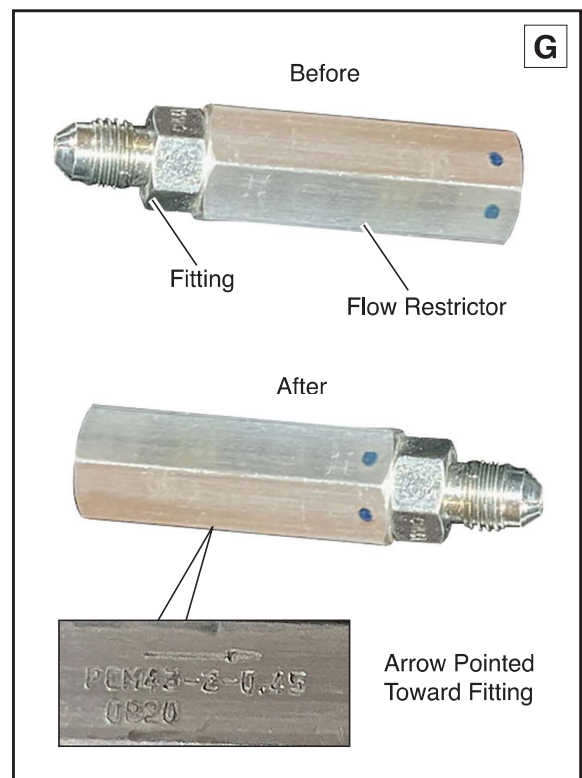

Pressure Switch Relocation Instructions 407587 Rev. A

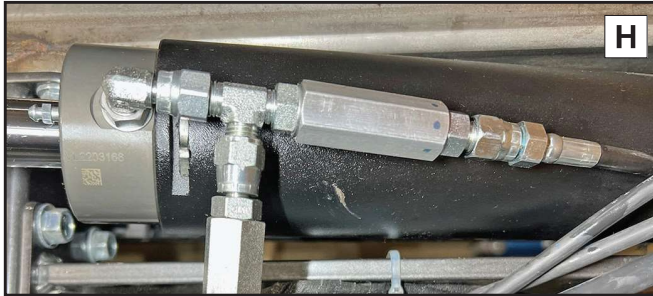

10. Connect flow restrictor to tee connector and connect hydraulic hose to flow restrictor. Tighten to snug. See Photo H.

11. Close manual relief valve.

12. Reconnect 2-pin high power connector.

13. Lock chain release.

14. Lower lift to ground level.

15. Operate lift through several cycles. If barrier deploys too early/late, adjust ground sense pressure switch, detailed at right.

16. Adjust Pressure Switch. A 1/16" Allen wrench will be needed.

- Remove the adjustment screw cover and turn the adjustment screw in all the way clockwise.
- Turn adjustment screw 5 complete revolutions counterclockwise.
- Cycle lift from floor to ground to ensure the out board barrier does not open until the platform is on the ground.

Ground Sense Pressure Switch: The Stow pressure switch is factory set and should not need adjustment. However, adjustment may be necessary if the actuator does not automatically lower the outer barrier once the platform is at ground level.

To reset the pressure switch:

1. Verify outer barrier actuator functionality before adjusting the platform fold pressure.
2. Using hand pendant, platform to ground level.
3. Remove the cover plug on pressure switch with 2 mm Allen wrench as shown in Figure A
4. Insert 2 mm Allen into pressure switch to access the pressure adjustment screw inside. See Figure B.
5. Press and hold Down hand pendant switch and turn adjustment screw counterclockwise until actuator fully lowers the outer barrier.
6. Using hand pendant, raise platform and then lower back to ground level. Verify outer barrier deployment occurs after platform contacts the ground.
7. Replace cover plug on pressure switch.

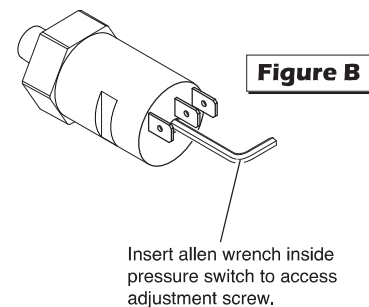
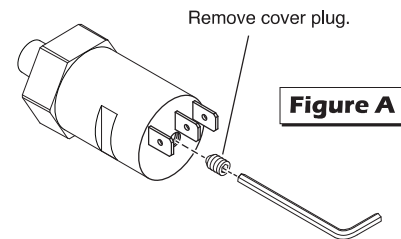

Pressure Switch Relocation Instructions 407587 Rev. A

Procedure With Lift on Shipping Skid

1. Open manual relief valve.
2. Perform Steps 7 through 11 in *Pressure Switch Relocation With Lift in Bus* section.
3. Lower lift to the ground upon installation in a bus.