

July 5, 2023

Version 4

Safety Recall: 2019–22 Pilot, 2019-23 Passport Install FAKRA Service Cables at MOST Bus Network

Supersedes 23-047, dated June 20, 2023, to revise the information highlighted in **yellow**.

AFFECTED VEHICLES

Year	Model	Trim Level	VIN Range
2019–22	Pilot	ALL Except LX	Check iN for VIN Eligibility
2019–23	Passport	ALL Except Sport	Check iN for VIN Eligibility

REVISION SUMMARY

Under PARTS INFORMATION, some part descriptions were revised.

Under WARRANTY CLAIM INFORMATION, labor operation number 0101T2 description was updated.

BACKGROUND

A coaxial cable terminal was not manufactured to proper specifications. An improperly manufactured terminal may lead to poor communication in the MOST bus network which can potentially affect the quality of audio sound and/or potentially cause the rearview camera to work intermittently or go blank when the vehicle is in the reverse gear.

CUSTOMER NOTIFICATION

Owners of affected vehicles will be sent a notification of this safety recall.

Do an iN VIN status inquiry to verify eligibility.

Some vehicles affected by this campaign may be in your new or used vehicle inventory.

Failure to repair a vehicle subject to a recall or campaign may subject your dealership to claims or lawsuits from the customer or anyone else harmed as a result of such. To see if a vehicle in inventory is affected by this safety recall, do a VIN status inquiry before selling it.

NOTE: ALL VEHICLES AFFECTED on this action must be repaired even if the vehicle was previously repaired using the following Service Bulletins:

- 20-049, 2021 Passport/Pilot: Popping or Crackling from the Speakers; No Sound from the Audio System; Network Loss Message and/or Display Issues
- 21-013, Warranty Extension: 2019–20 Passport/Pilot MOST Bus Network Connectors

CORRECTIVE ACTION

Install the FAKRA splice repair service cables and splice boxes.

CUSTOMER INFORMATION: The information in this bulletin is intended for use only by skilled technicians who have the proper tools, equipment, and training to correctly and safely maintain your vehicle. These procedures should not be attempted by “do-it-yourselfers,” and you should not assume this bulletin applies to your vehicle, or that your vehicle has the condition described. To determine whether this information applies, contact an authorized Honda automobile dealer.

PARTS INFORMATION

2019–2022 Pilot (EX, EX-L, SE, Sport, TrailSport)

Part Name	Part Number	Quantity
Splice Box (Halves)	39817-THR-305	6 splice boxes (12 halves)
FAKRA splice repair service cable (Green)	39165-THR-AB0	2
FAKRA splice repair service cable (Red)	39165-THR-AA0	2
FAKRA splice repair service cable (Blue)	39165-THR-AC0	2

2019–2022 Pilot (EX, EX-L, Sport) Accessory CD Player P/N 08A06-TG7-100E, Attachment Kit P/N 08A06-TG7-110F

Part Name	Part Number	Quantity
Splice Box (Halves)	39817-THR-305	1 splice boxes (2 halves)
FAKRA splice repair service cable (Green)	39165-THR-AB0	2

2019–2022 Pilot (EX, EX-L, Sport) Accessory CD Player P/N 08A06-TG7-100C, Attachment Kit P/N 08A06-TG7-110B

Part Name	Part Number	Quantity
Splice Box (Halves)	39817-THR-305	3 splice boxes (6 halves)
FAKRA Splice repair service cable (Green)	39165-THR-AB0	2
90° FAKRA splice repair service cable (Green)	39165-TG7-AE0	1
90° FAKRA splice repair service cable (Red)	39165-TG7-AF0	1

2021–2022 Pilot (Touring, Touring 7, Elite, Black Edition)

Part Name	Part Number	Quantity
Splice Box (Halves)	39817-THR-305	8 splice boxes (16 halves)
FAKRA splice repair service cable (Green)	39165-THR-AB0	3
FAKRA splice repair service cable (Red)	39165-THR-AA0	3
FAKRA splice repair service cable (Blue)	39165-THR-AC0	2

2019–2020 Pilot (EX-L RES, EX-L Navigation/RES)

Part Name	Part Number	Quantity
Splice Box (Halves)	39817-THR-305	8 splice boxes (16 halves)
FAKRA splice repair service cable (Green)	39165-THR-AB0	2
FAKRA splice repair service cable (Red)	39165-THR-AA0	2
FAKRA splice repair service cable (Blue)	39165-THR-AC0	2
90° FAKRA splice repair service cable (Green)	39165-TG7-AE0	1
90° FAKRA splice repair service cable (Red)	39165-TG7-AF0	1

2019–2020 Pilot (Touring, Touring 7, Elite, Black Edition)

Part Name	Part Number	Quantity
Splice Box (Halves)	39817-THR-305	10 splice boxes (20 halves)
FAKRA splice repair service cable (Green)	39165-THR-AB0	3
FAKRA splice repair service cable (Red)	39165-THR-AA0	3
FAKRA splice repair service cable (Blue)	39165-THR-AC0	2
90° FAKRA splice repair service cable (Green)	39165-TG7-AE0	1
90° FAKRA splice repair service cable (Red)	39165-TG7-AF0	1

2019–2023 Passport (Elite, Touring)

Part Name	Part Number	Quantity
Splice Box (Halves)	39817-THR-305	8 splice boxes (16 halves)
FAKRA splice repair service cable (Green)	39165-THR-AB0	3
FAKRA splice repair service cable (Red)	39165-THR-AA0	3
FAKRA splice repair service cable (Blue)	39165-THR-AC0	2

2019–2023 Passport (EX, EX-L, TrailSport)

Part Name	Part Number	Quantity
Splice Box (Halves)	39817-THR-305	6 splice boxes (12 halves)
FAKRA splice repair service cable (Green)	39165-THR-AB0	2
FAKRA splice repair service cable (Red)	39165-THR-AA0	2
FAKRA splice repair service cable (Blue)	39165-THR-AC0	2

2019–2021 Passport (EX, EX-L, Sport) Accessory CD Player**P/N 08A06-TG7-100E, Attachment Kit P/N 08A06-TG7-110F**

Part Name	Part Number	Quantity
Splice Box (Halves)	39817-THR-305	1 splice box (2 halves)
FAKRA splice repair service cable (Green)	39165-THR-AB0	2

2019–2021 Passport (EX, EX-L, Sport) Accessory CD Player**P/N 08A06-TG7-100C, Attachment Kit P/N 08A06-TG7-110B**

Part Name	Part Number	Quantity
Splice Box (Halves)	39817-THR-305	3 splice boxes (6 halves)
FAKRA splice repair service cable (Green)	39165-THR-AB0	2
90 Deg FAKRA Splice repair service cable (Green)	39165- TG7-AE0	1
90 Deg FAKRA Splice repair service cable (Red)	39165- TG7-AF0	1

TOOL INFORMATION

Tool Name	Part Number	Quantity
Straight FAKRA puller	07AAC-THRA200	1
90° FAKRA A puller	07AAC-THRA100	1
90° FAKRA B puller	07AAC-TJBA100	1
Digital Borescope	BK5600DUAL55	1

WARRANTY CLAIM INFORMATION

Operation Number	Description	Flat Rate Time	Defect Code	Symptom Code	Template ID	Failed Part Number
0101S9	2019-2022 Pilot (EX, EX-L, SE, Sport, TrailSport): Access the gauge control module, Infotainment Control Unit, and in-line connectors. Replace the affected FAKRA connectors with FAKRA splice repair service cables, and splice boxes.	1.2 hr	6MX00	ZEM00	A23047A	39540-TG7-AA4
A	For Accessory CD Player -Add with P/N 08A06-TG7-100E -Add (include photo of CD serial number)	0.2 hr	6MX00	ZEM00	A23047B	39540-TG7-AA4
A	For Accessory CD Player -Add with P/N 08A06-TG7-100C -Add (include photo of CD serial number)	0.2 hr	6MX00	ZEM00	A23047J	39540-TG7-AA4
0101T0	2021-2022 Pilot (Touring, Touring 7, Elite, Black Edition): Access the gauge control module, Infotainment Control Unit, tuner unit, and in-line connectors. Replace the affected FAKRA connectors with FAKRA splice repair service cables, and splice boxes.	1.7 hr	6MX00	ZEM00	A23047C	39540-TG7-AP4
0101T1	2019-2020 Pilot (EX-L RES, EX-L Navigation/RES): Access the gauge control module, Infotainment Control Unit, Blu-ray player, and in-line connectors. Replace the affected FAKRA connectors with FAKRA splice repair service cables, and splice boxes.	1.5 hr	6MX00	ZEM00	A23047D	39540-TG7-AD4
0101T2	2019-2020 Pilot (Touring, Touring 7, Elite, Black Edition): Access the gauge control module, Infotainment Control Unit, Blu-ray player, tuner unit, and in-line connectors. Replace the affected FAKRA connectors with FAKRA splice repair service cables, and splice boxes.	2.0 hr	6MX00	ZEM00	A23047E	39540-TG7-AF4

Operation Number	Description	Flat Rate Time	Defect Code	Symptom Code	Template ID	Failed Part Number
0101S9	2019–2023 Passport (EX-L, EX, TrailSport): Access the gauge control module, Infotainment Control Unit. Replace the affected FAKRA connectors with FAKRA splice repair service cables, and splice boxes.	1.4 hr	6MX00	ZEM00	A23047F	39540-TGT-AB2
A	2019–2021 Passport Only, For Accessory CD Player with P/N 08A06-TG7-100E -Add (include photo of CD serial number)	0.2 hr	6MX00	ZEM00	A23047G	39540-TGT-AB2
A	2019–2021 Passport Only, For Accessory CD Player with P/N 08A06-TG7-100C -Add (include photo of CD serial number)	0.2 hr	6MX00	ZEM00	A23047K	39540-TGT-AB2
0101T0	2019–2023 Passport (Touring, Elite): Access the gauge control module, Infotainment Control Unit, turner unit, and in-line connectors. Replace the affected FAKRA connectors with FAKRA splice repair service cables, and splice boxes.	1.7 hr	6MX00	ZEM00	A23047H	39540-TGS-AD2
A	2019–2021 Passport Only, For accessory CD Player with P/N 08A06-TG7-100E – Add (include photo of CD serial number)	0.2 hr	6MX00	ZEM00	A23047L	39540-TGS-AD2
A	2019–2021 Passport Only, For accessory CD Player with P/N 08A06-TG7-100C – Add (include photo of CD serial number)	0.2 hr	6MX00	ZEM00	A23047M	39540-TGS-AD2

Skill Level: Repair Technician

FAKRA CONNECTOR HOUSING DISASSEMBLY/FAKRA SPLICE REPAIR SERVICE CABLE ASSEMBLY PROCEDURE

1. Follow the below steps to better understand the cable and splice box installation instructions.
2. The connectors will either be the original FAKRA housing or the WPC FAKRA service housing.

NOTE:

- There may be multiple components that require the affected FAKRA connectors to be removed.
- Use either the straight FAKRA puller or the 90° FAKRA A/B Puller to remove the connector from a component.
- Refer to either **page 11** for the Pilot repair procedure or **page 39** for the Passport repair procedure.

Original FAKRA Housing Removal Procedure

1. Use a small screwdriver, remove the secondary lock, then release the tab as shown.

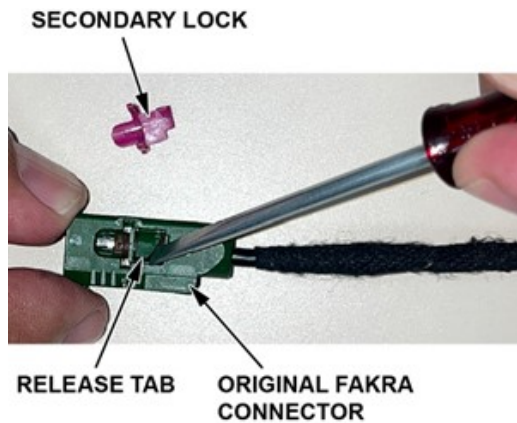

2. Pull to remove the housing from the vehicle harness. Then, **discard** the housing and lock.

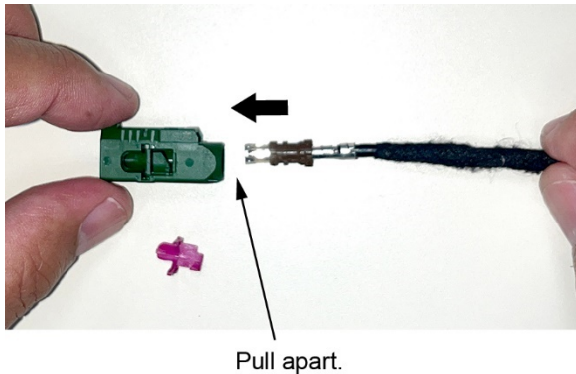

WPC FAKRA Service Housing Removal Procedure

1. Release the two locking tabs on the WPC FAKRA Service Housing and remove the housing from the terminal.

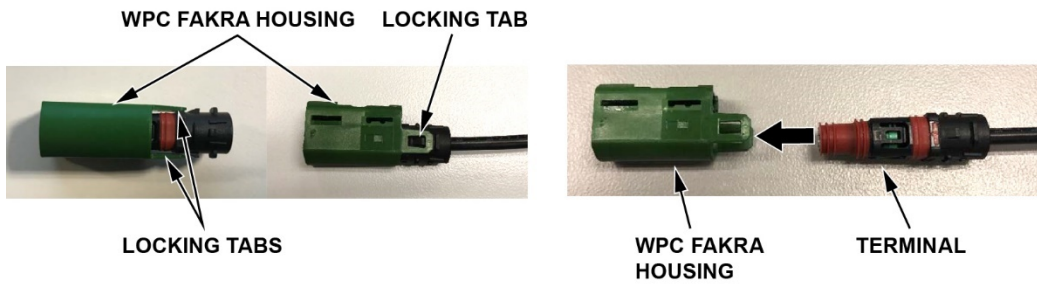

2. Release the lock tab and remove the terminal from the vehicle harness.

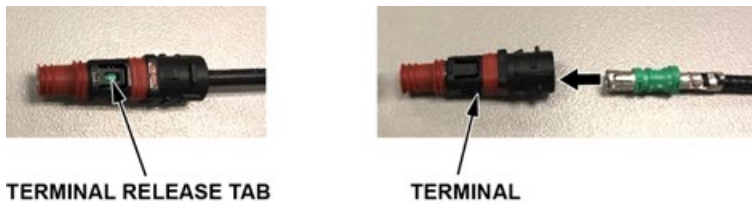

FAKRA Splice Repair Service Cable Assembly

1. Install the appropriate FAKRA splice repair service cables and splice boxes as shown in the steps that follow:

NOTE:

- The splice box arrow must always point in the direction of either the red flag label or red sleeve on the FAKRA splice repair service cable.
- If the splice box is installed **incorrectly**, the repair will fail; MOST ring failure conditions will still occur.

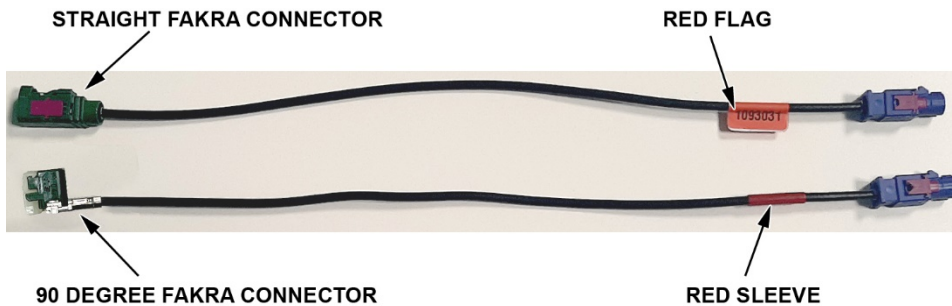

2. Use a small screwdriver to remove the secondary lock and then, release the tab.

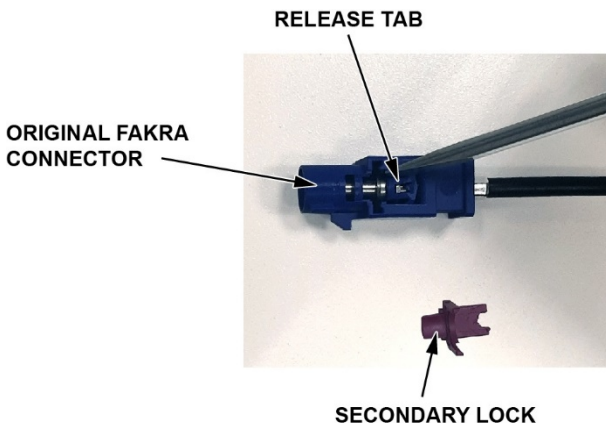

3. Pull to remove the housing from the cable and then discard the housing and secondary lock tab from the FAKRA splice repair service cable.

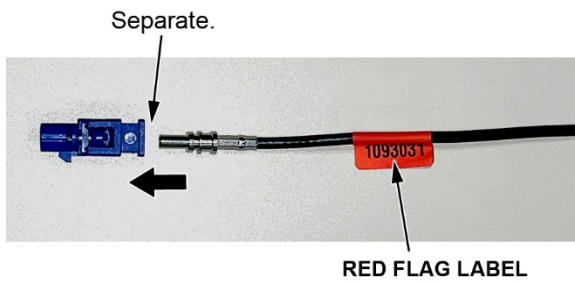

4. Connect the appropriate color FAKRA splice repair service cable to the vehicle harness.
NOTE: Always disassemble the connectors one at a time to avoid swapping the green and red wires.

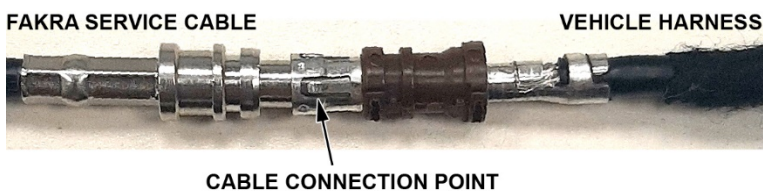

5. Attach the splice box halves to the cable connection.

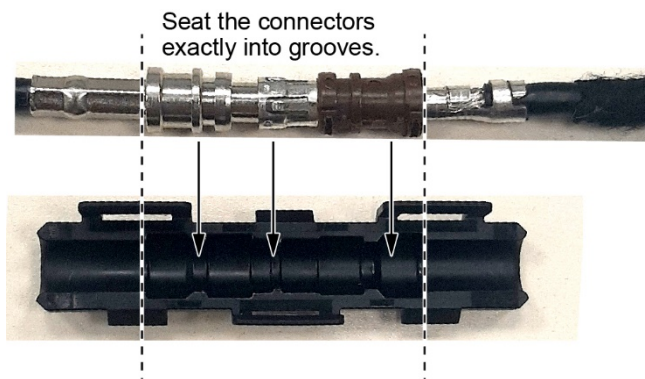

6. When mating the two splice box halves, **make sure** that all **6 lock tabs** are fully engaged. You may hear a click when installing the two halves.

NOTE:

- The splice box arrow must always point in the direction of the red flag label or red sleeve on the FAKRA splice repair service cable.
- If any of the lock tabs break during installation, the splice box halve(s) must be replaced.
- If the splice box is installed **incorrectly**, the repair **will fail**; MOST Ring failure conditions will still occur.

CORRECT ✓

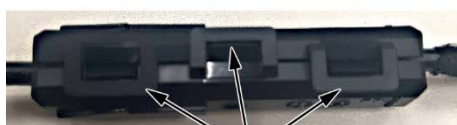

All 6 clips connected.

INCORRECT ✗



Exposed slice visible.

7. Make sure the arrow on the splice box **faces** towards the tag.



8. Once the FAKRA splice repair service cables and splice boxes have been attached to the cable connection, tape the splice boxes and FAKRA service cables to the appropriate component harness.



Keep smooth curves with a radius bend greater than 25 mm.



Keep smooth curves with a radius bend greater than 25 mm.



REPAIR PROCEDURE – PILOT

PILOT – TRIM REMOVAL PROCEDURE

1. Remove the side cover.



2. Loosen the upper column cover.



3. Remove the lower dash panel.

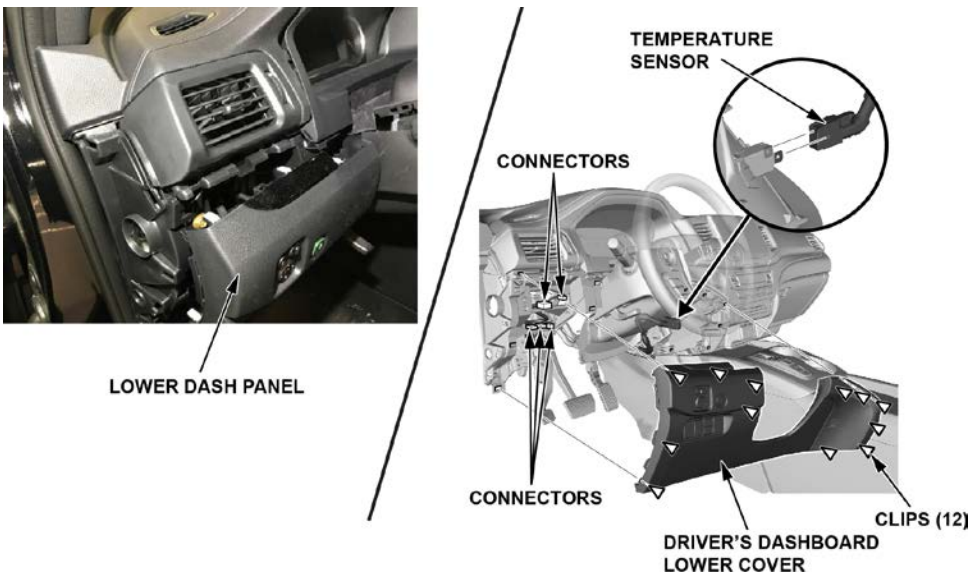

4. Pull back the middle dash trim to allow the meter bezel removal.



5. Remove the meter bezel and upper column cover as one piece.

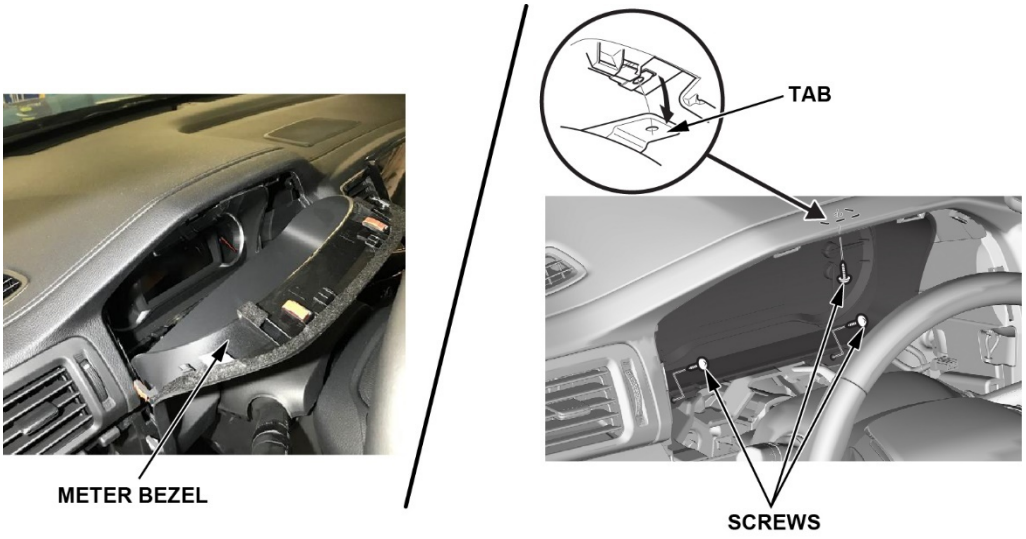

6. Remove the passenger side cover.



7. Remove the passenger dashboard trim panel.

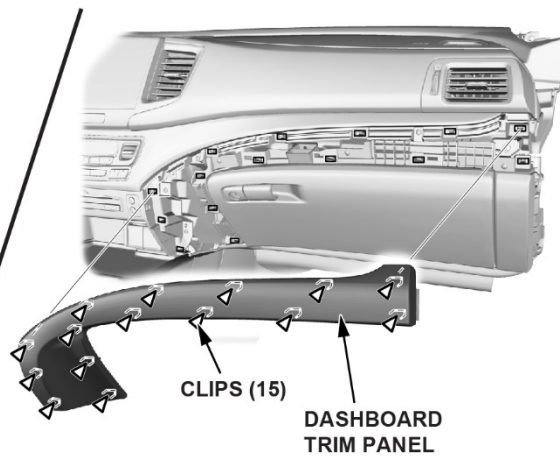

8. Remove the dashboard center middle trim.

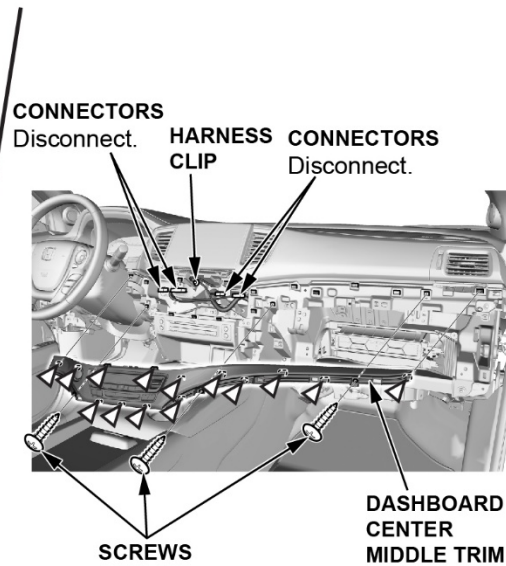

9. Remove the dashboard center panel.

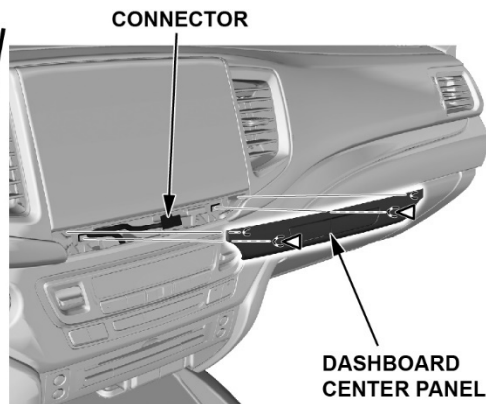

10. Remove the screws and bolts to remove the Blu-Ray player or dashboard center lower panel.

NOTE:

- Some trim levels may have an accessory CD player installed, see **PILOT – ACCESSORY CD PLAYER REPAIR PROCEDURE**.
- Make sure to protect the center console and the surrounding surfaces.

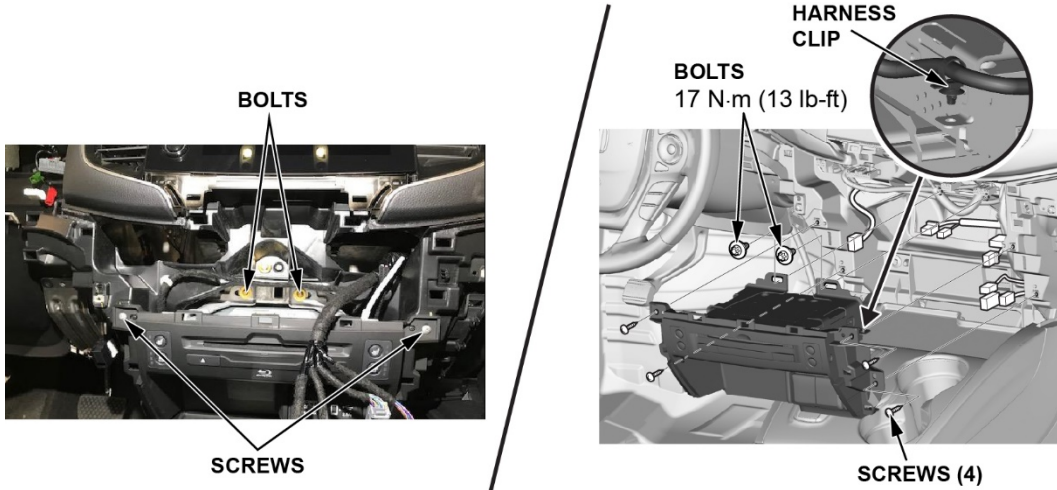

11. Loosen the two bolts holding the Infotainment Control Unit.

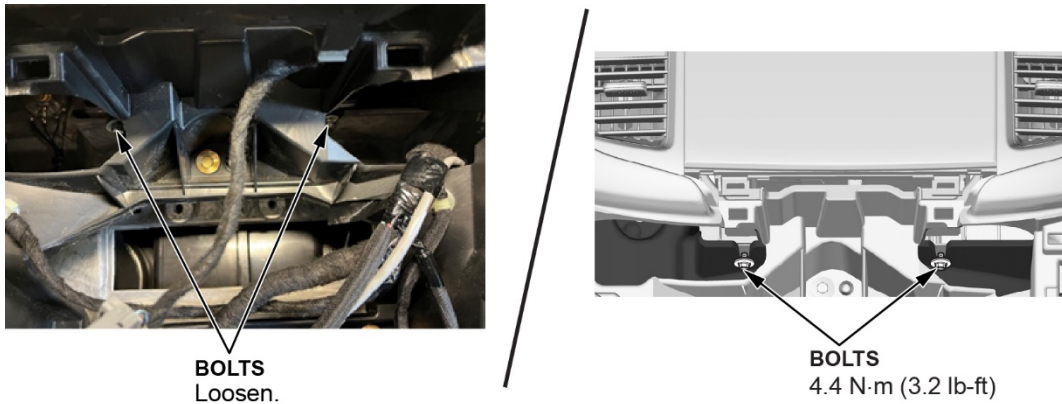

12. Remove the Infotainment Control Unit.

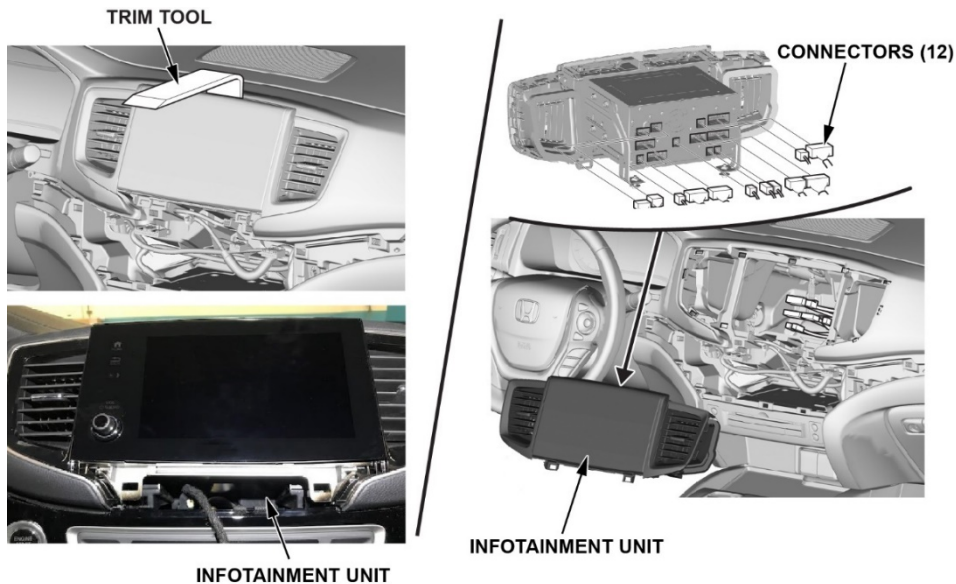

13. Remove undercover for the glove box.

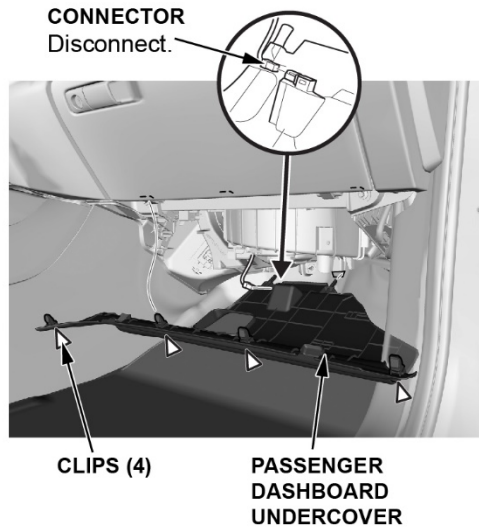

14. Remove the passenger door kick panel.

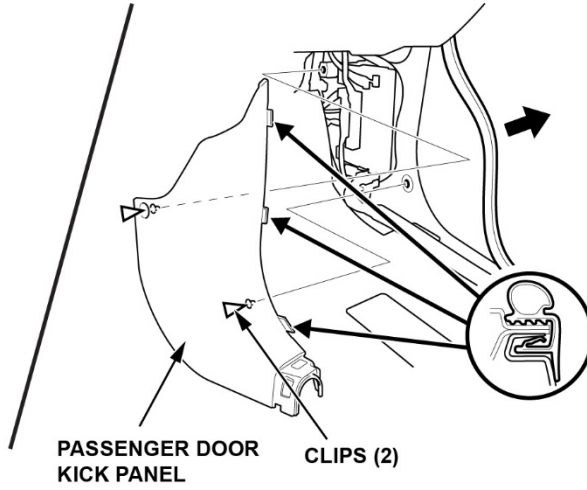
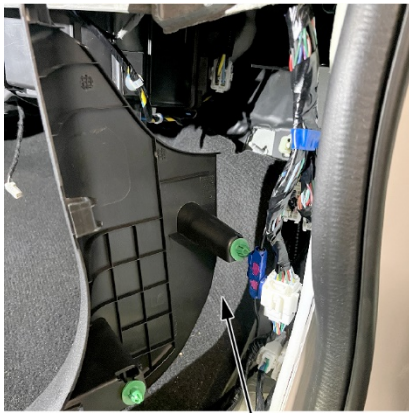

15. Remove the passenger console kick panel.

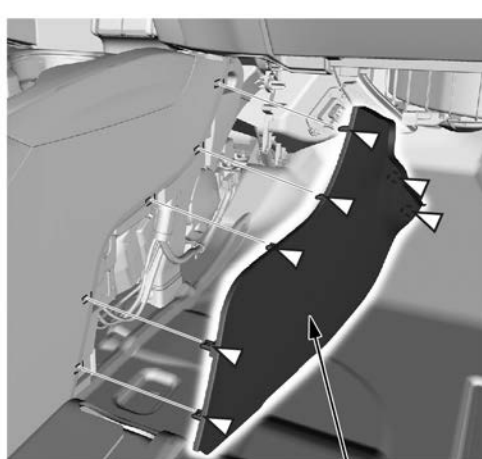
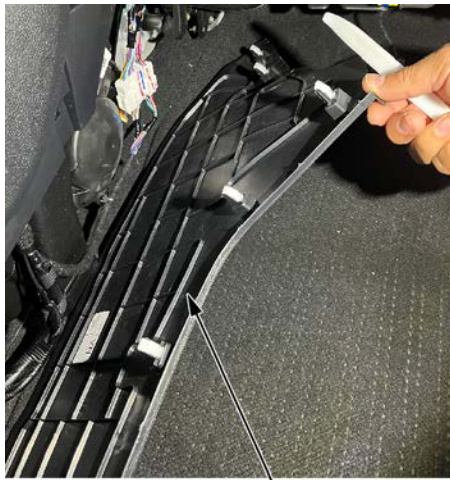

16. Remove the rear cargo trim panel.

NOTE:

- For **EX** and **EX-L** trim levels, go to the **PILOT – GAUGE CONTROL MODULE REPAIR PROCEDURE**.
- For **Touring**, **Elite**, and **Black Edition** continue to the **next step**.

17. Remove the aluminum support brace by removing the two bolts.

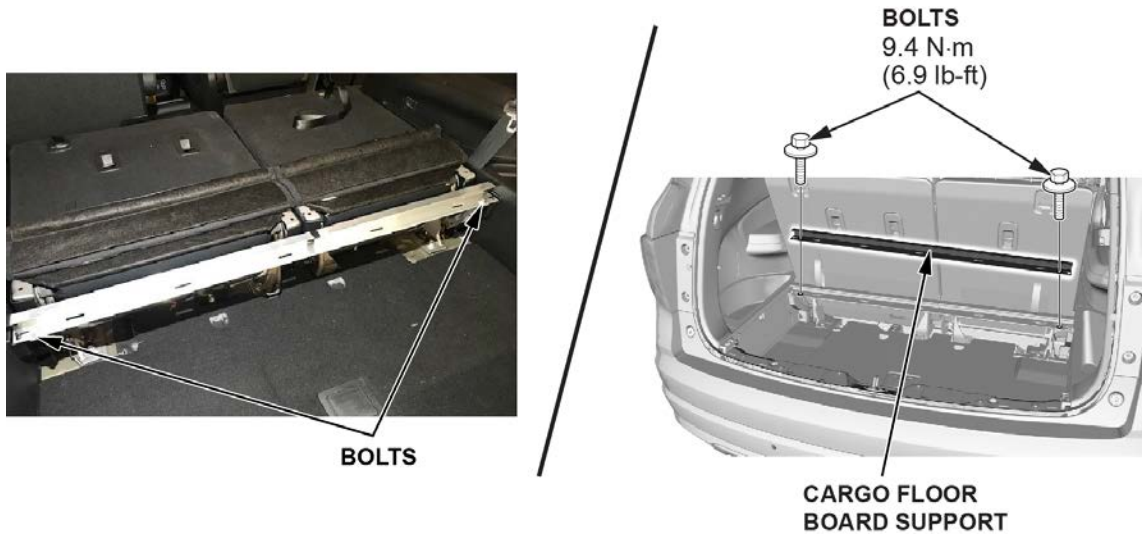

18. Remove the two rear bolts for the right third-row seat.

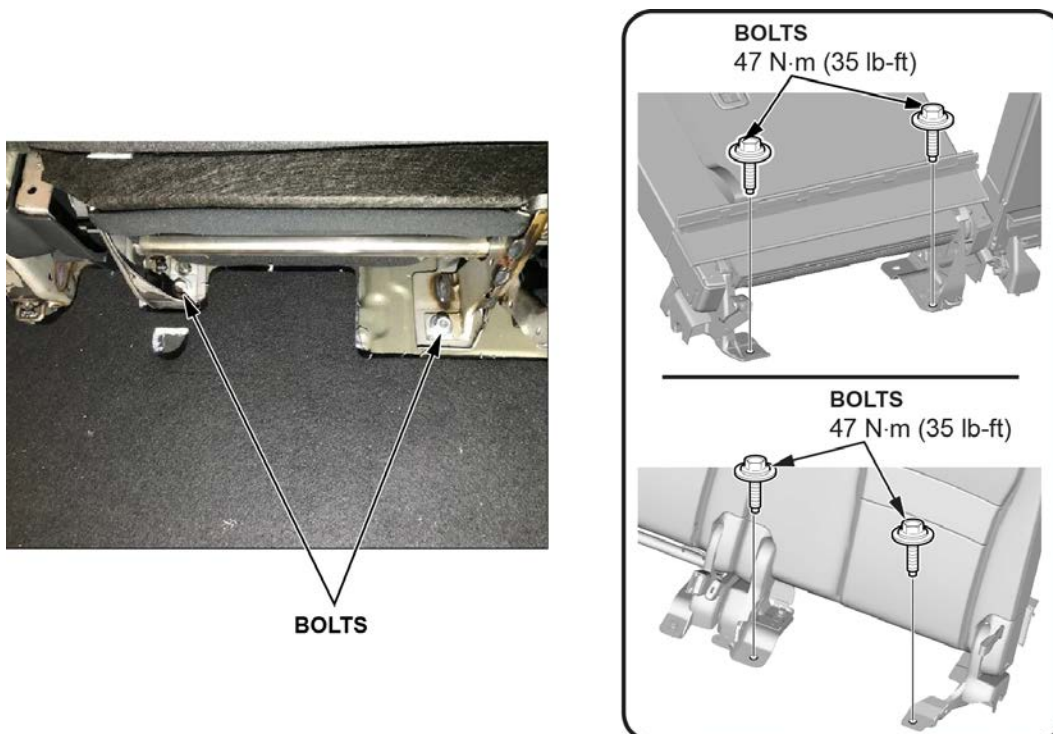

19. Remove the third-row lower seat cushion by removing the three bolts.



BOLTS

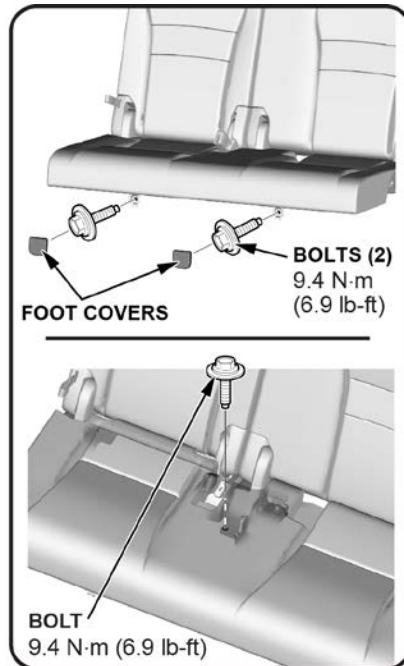

21. Remove the two front bolts for the passenger third-row seat back.



BOLTS

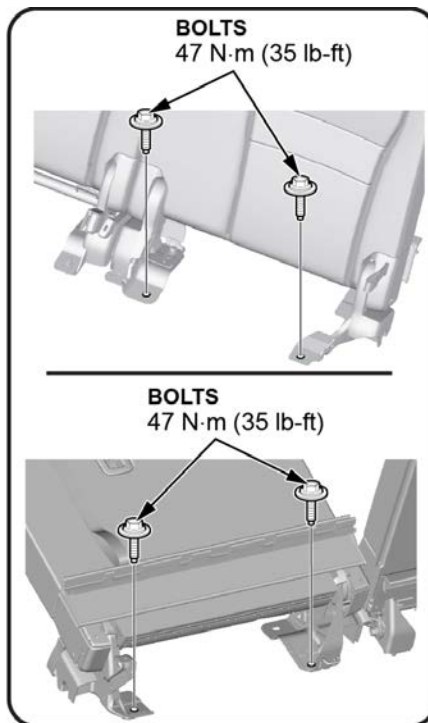

22. Remove the passenger rear door sill upper trim.



PASSENGER DOOR
LOWER TRIM

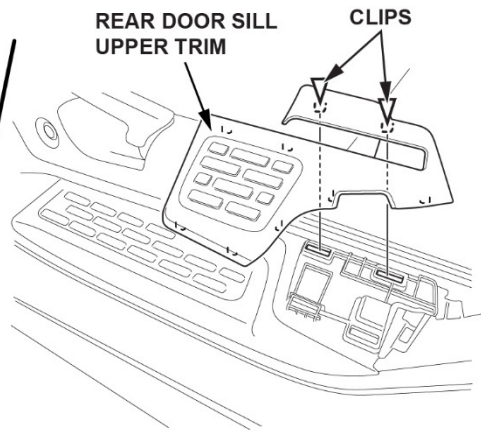

23. Remove the securing points on the right rear quarter panel.



BOLTS

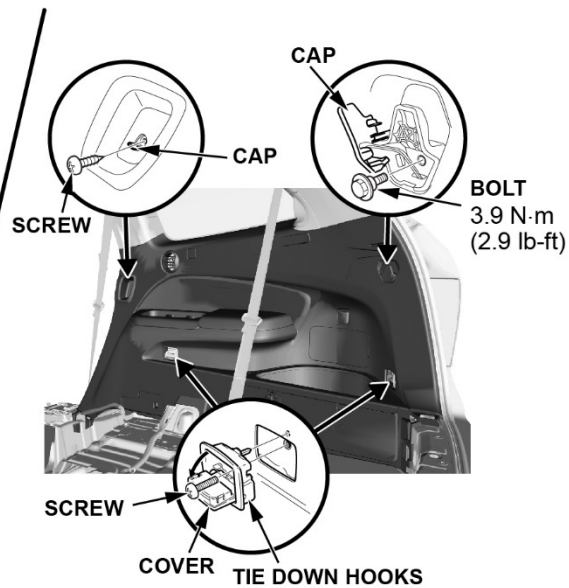

24. Follow the steps below to install the FAKRA splice repair service cables and splice boxes at **each** component location.

NOTE: See the **FAKRA CONNECTOR HOUSING DISASSEMBLY/FAKRA SPLICE REPAIR SERVICE CABLE ASSEMBLY PROCEDURE SECTION** above for cable and splice box installation instructions.

PILOT – GAUGE CONTROL MODULE REPAIR PROCEDURE

1. Locate and turn the gauge control module to access the rear connectors.



2. Disconnect the red and green FAKRA connectors and any other related connectors from the gauge control module.

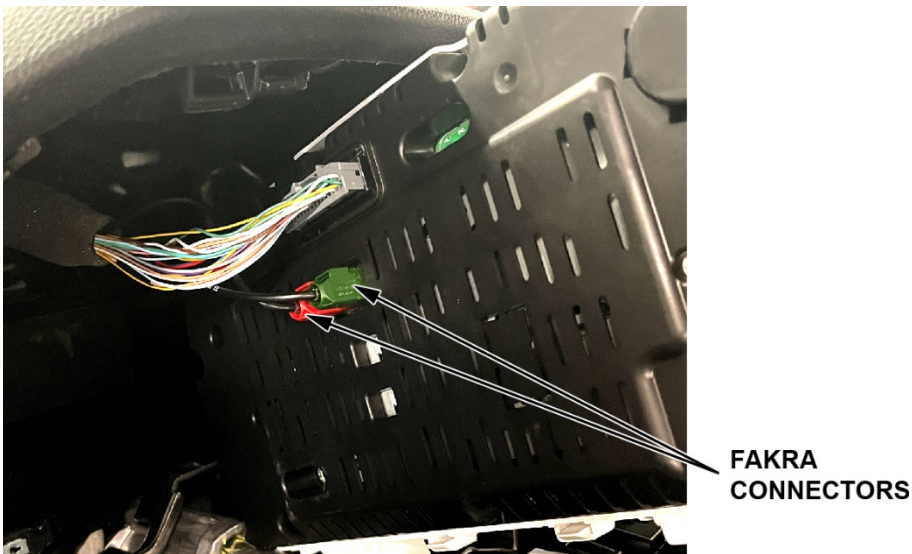

3. If the WPC FAKRA service housings and extension cables are installed, un-tape the WPC connectors, and extension cables from the vehicle harness.

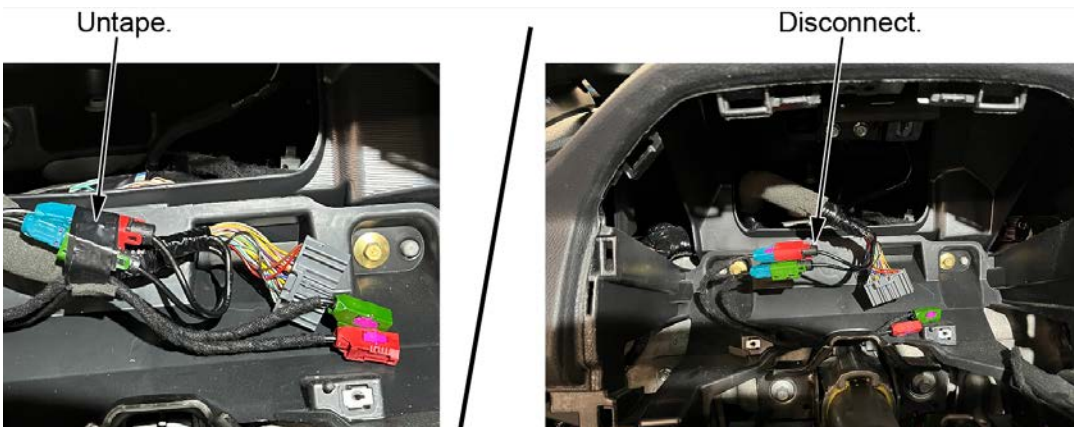

4. Remove the extension cables and then discard.

NOTE: Disassemble the connectors one at a time to avoid swapping the green and red wires.

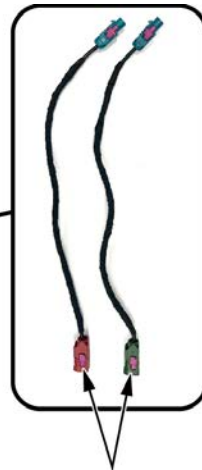

EXTENSION CABLES
Remove and discard.

5. Install the matching color FAKRA splice repair service cables and splice boxes.

NOTE:

- See the above section **FAKRA CONNECTOR HOUSING DISASSEMBLY/FAKRA SPLICE REPAIR SERVICE CABLE ASSEMBLY PROCEDURE SECTION** for detailed instructions.
- **The splice box arrow must always point in the direction of the red flag label or red sleeve on the FAKRA splice repair service cable.**
- If any of the lock tabs break during installation, the splice box halve(s) must be replaced.
- If the splice box is installed **incorrectly**, the repair **will fail**; MOST Ring failure conditions will still occur.

6. Tape both splice boxes and cables to the gauge control module harness.

Attach FAKRA service cables and splice boxes to the appropriate component harness with tape to prevent any rattles.



Keep smooth curves with a radius bend greater than 25 mm.

7. Reconnect the FAKRA connectors and any other related connectors to the gauge control module.
8. Install the gauge control module into its mounting position.

9. Using the digital borescope (T/N BK5600DUAL55) or a commercially available borescope with multiple view angles, inspect the cable routing at the back of the gauge control module as shown below to make sure the cables are routed straight and not sideloaded. Adjust gauge control module harness as needed to achieve proper cable routing.

LEFT SIDE

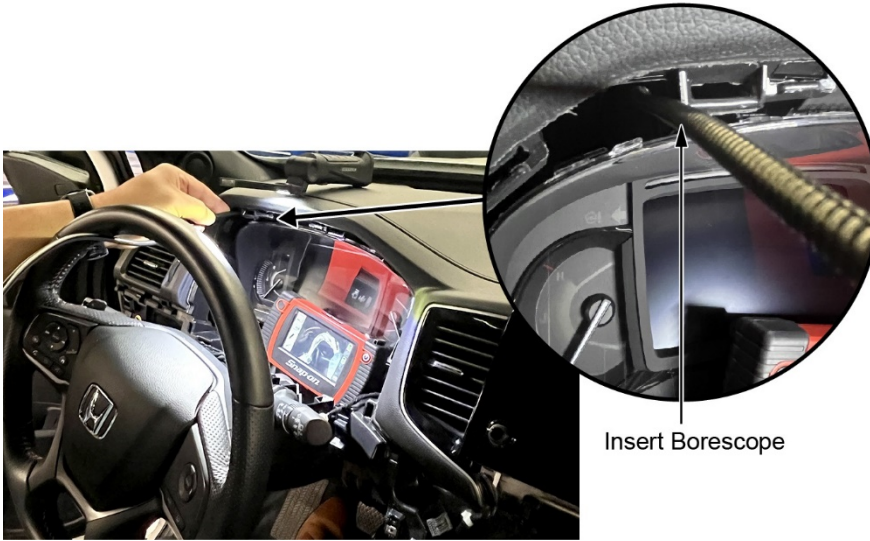

Insert Borescope

RIGHT SIDE

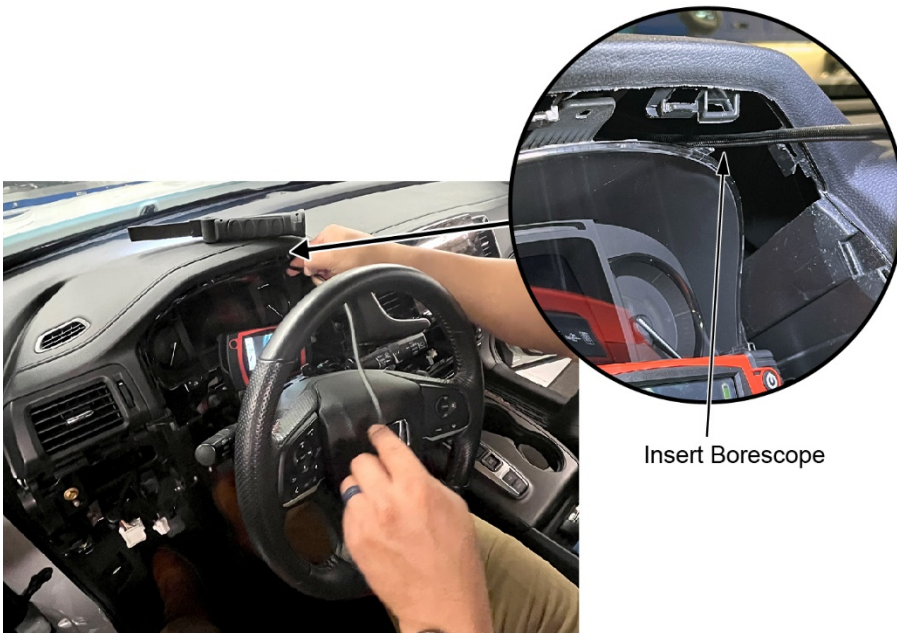

Insert Borescope

CORRECT ✓

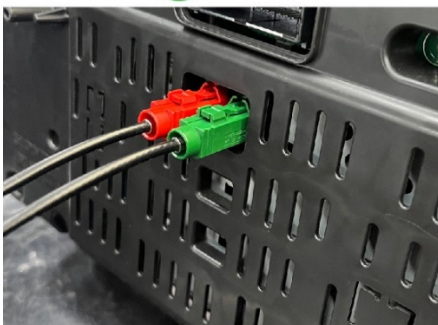

INCORRECT ✗

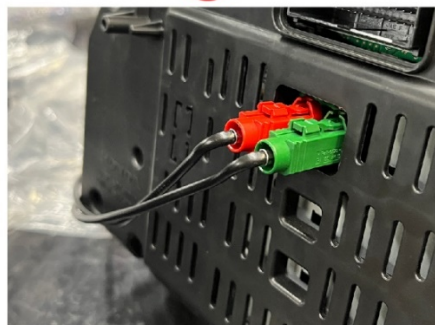

10. Once you have confirmed the cable routing is correct, install the gauge control module.

PILOT – BLU-RAY PLAYER REPAIR PROCEDURE (Only applies to 2019–2020 trims with RES)

1. Disconnect the red and green FAKRA connectors and any other related connectors at the Blu-Ray player.
2. If the WPC FAKRA service housings and 90° extension cables are installed, untape the WPC connectors and extension cables from the vehicle harness.

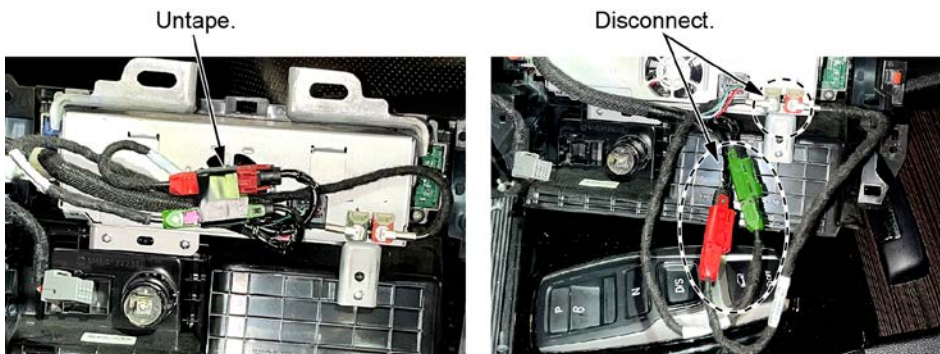

3. Remove the 90° extension cables and then, discard.

NOTE: Disassemble the connectors one at a time to avoid swapping the green and red wires.

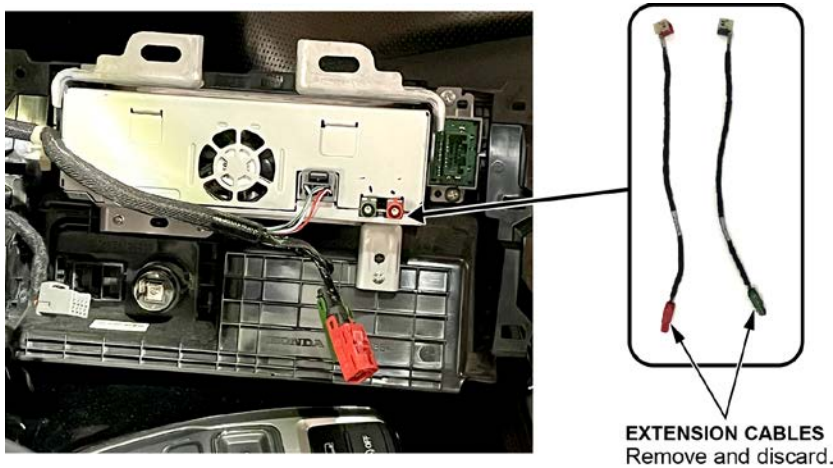

4. Install the matching color 90° FAKRA splice repair service cables and splice boxes.

NOTE:

- See the above section **FAKRA CONNECTOR HOUSING DISASSEMBLY/FAKRA SPLICE REPAIR SERVICE CABLE ASSEMBLY PROCEDURE SECTION** for detailed instructions.
- **The splice box arrow must always point in the direction of the red flag label or red sleeve on the FAKRA splice repair service cable.**
- If any of the lock tabs break during installation, the splice box halve(s) must be replaced.
- If the splice box is installed **incorrectly**, the repair **will fail**; MOST Ring failure conditions will still occur.

5. Tape both splice boxes and cables to the Blu-Ray player harness.

Keep smooth curves with a radius bend greater than 25 mm.

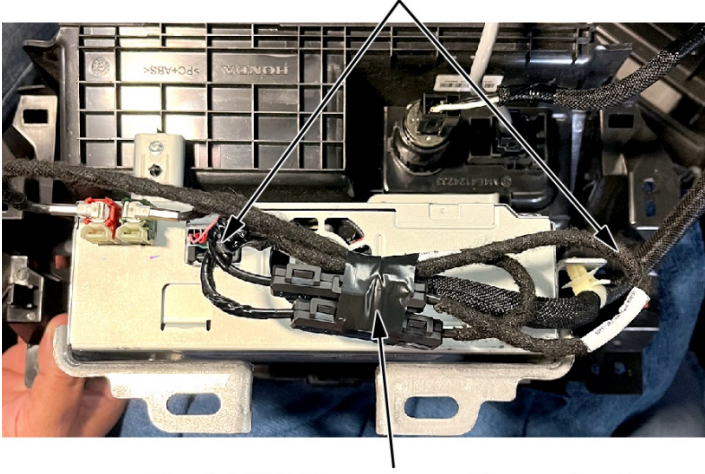

Attach FAKRA service cables and splice boxes to the appropriate component harness with tape to prevent any rattles.

6. Reconnect the FAKRA connectors and any other related connectors to the Blu-Ray player.

PILOT – INFOTAINMENT CONTROL UNIT REPAIR PROCEDURE

1. Remove the Infotainment Control Unit.
2. Disconnect the red and green FAKRA connectors and any other related connectors at the Infotainment Control Unit.

NOTE:

- Make sure to protect the center console and the surrounding surfaces when working on the Infotainment Control Unit.
- Disassemble the connectors one at a time to avoid swapping the green and red wires.
- Begin the **PILOT – ACCESSORY CD PLAYER REPAIR PROCEDURE** if a CD player is present.
- **If not**, proceed to the **next step**.

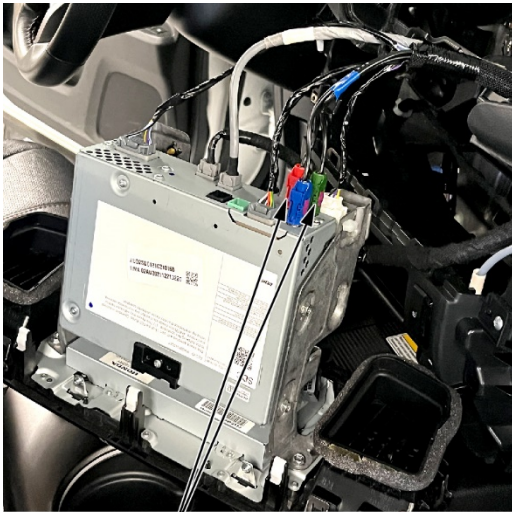

FAKRA CONNECTORS

3. Install the matching color FAKRA splice repair service cables and splice boxes.

NOTE:

- See the above section **FAKRA CONNECTOR HOUSING DISASSEMBLY/FAKRA SPLICE REPAIR SERVICE CABLE ASSEMBLY PROCEDURE SECTION** for detailed instructions.
- **The splice box arrow must always point in the direction of the red flag label or red sleeve on the FAKRA splice repair service cable.**
- If any of the lock tabs break during installation, the splice box halve(s) must be replaced.
- If the splice box is installed **incorrectly**, the repair **will fail**; MOST Ring failure conditions will still occur.

4. Tape both splice boxes and cables to the Infotainment Control Unit harness.

Keep smooth curves with a radius bend greater than 25 mm.



Attach FAKRA service cables and splice boxes to the appropriate component harness with tape to prevent any rattles.

5. Reconnect the FAKRA connectors and any other related connectors to the Infotainment Control Unit.
6. Install the Infotainment Control Unit into its mounting position.
7. Using the digital borescope (T/N BK5600DUAL55) or a commercially available borescope with multiple view angles, inspect the cable routing at the back of the gauge control module as shown below to make sure the cables are routed straight and not sideloaded. Adjust gauge control module harness as needed to achieve proper cable routing.



Insert borescope.



BORESCOPE

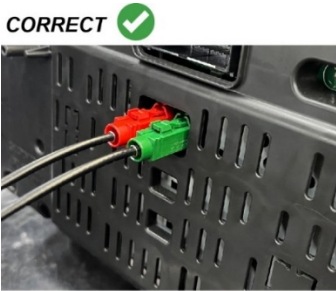

CORRECT ✓



INCORRECT ✗

8. Once you have confirmed the cable routing is correct, install the Infotainment Control Unit mounting screws.

PILOT – ACCESSORY CD PLAYER REPAIR PROCEDURE

CD Player P/N 08A06-TG7-100E (FAKRA Connector Lock Tabs Pointing Down at 6 O'clock)
Attachment Kit 08A06-TG7-110F (Includes 90° Connectors)

Cable Connection Layout for Accessory CD Player P/N 08A06-TG7-100E With Attachment Kit 08A06-TG7-110F (Include 90° Connectors)

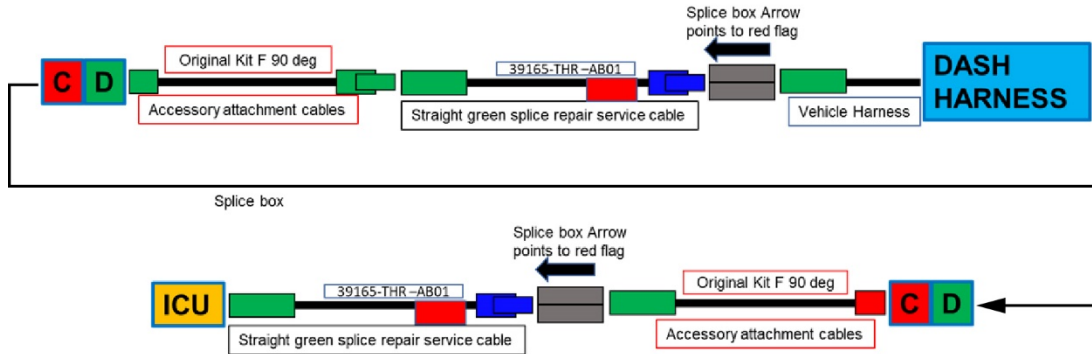

1. With the CD player removed in the **PILOT – TRIM REMOVAL PROCEDURE** section, determine if the CD player P/N is **08A06-TG7-100E** (FAKRA connector lock tabs pointing down at 6 o'clock). **If not**, proceed to **step 20**.
2. Take a clear photo of the Accessory CD player label located on the top of the CD player.

NOTE:

- In order for the warranty claim to be processed and your warranty administrator to be able to select the right template, you will need to include the photo of the CD label that includes the **serial number and the part number** when the claim is submitted
- Be sure to protect the center console and surrounding interior surfaces when working on the CD player

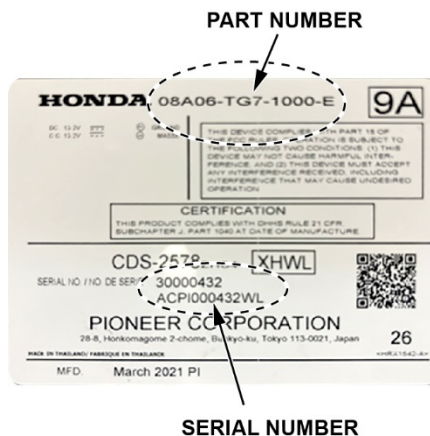

3. Disconnect the red and green 90° accessory attachment cables from the CD player, and the Infotainment Control Unit. Then, remove them from the dash.

NOTE: Disassemble the connectors one at a time to avoid swapping the green and red wires.

Kit F GREEN CABLE ASSEMBLY PROCEDURE (Attachment Kit 08A06-TG7-110F)

4. Plug in the green 90 deg accessory attachment cable into the green FAKRA Splice repair service cable.

NOTE: **Steps 4–8** are performed on the bench for best results.

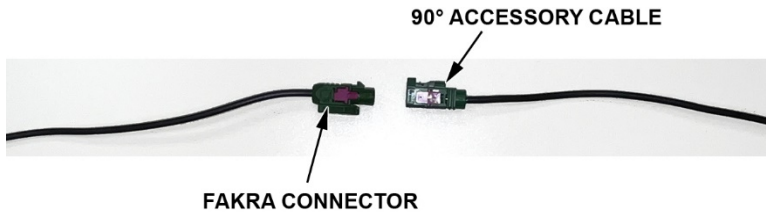

Kit F RED CABLE ASSEMBLY PROCEDURE (Attachment Kit 08A06-TG7-110F)

5. Connect the red 90 deg accessory attachment cable to the green FAKRA Splice repair service cable with the splice box.

NOTE:

- See the above section **FAKRA CONNECTOR HOUSING DISASSEMBLY/FAKRA SPLICE REPAIR SERVICE CABLE ASSEMBLY PROCEDURE SECTION** for detailed instructions.
 - If any of the lock tabs break during installation, the splice box halve(s) must be replaced.
 - If the splice box is installed **incorrectly**, the repair **will fail**; MOST Ring failure conditions will still occur.
6. With the green and red 90° accessory attachment cable connectors facing the same direction, tape the cables together at the halfway point between the 90° connectors and the splice box.



7. Tape the green 90° accessory attachment cable to the splice box.

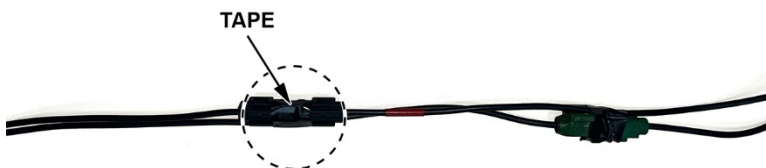

8. Tape the red 90° accessory attachment cable to the green connector.



9. Connect the green FAKRA splice repair service cable and splice box to the vehicle dash harness green connector cable.

NOTE:

- See the above section **FAKRA CONNECTOR HOUSING DISASSEMBLY/FAKRA SPLICE REPAIR SERVICE CABLE ASSEMBLY PROCEDURE SECTION** for detailed instructions.
 - If any of the lock tabs break during installation, the splice box halve(s) must be replaced.
 - If the splice box is installed **incorrectly**, the repair **will fail**; MOST Ring failure conditions will still occur.
10. Reconnect the green and red FAKRA connectors and any other related connectors to the Infotainment Control Unit.

11. Route the taped FAKRA splice repair service cables through the right side of the vehicle dash.



12. Connect the green and red 90° connectors to the CD player.
13. Position the CD unit into its mounting position.
14. Pull the excess cables up toward the Infotainment Control Unit.

NOTE: Make sure to leave some slack at the CD player connections.

15. Tape the splice box, the green connector, and the cables to the Infotainment Control Unit harness.

Keep smooth curves
with a radius bend
greater than 25mm.



Attach Fakra service cables and splice boxes to the appropriate component harness with tape to prevent any rattles.

16. Tape the splice box to the Infotainment Control Unit harness.

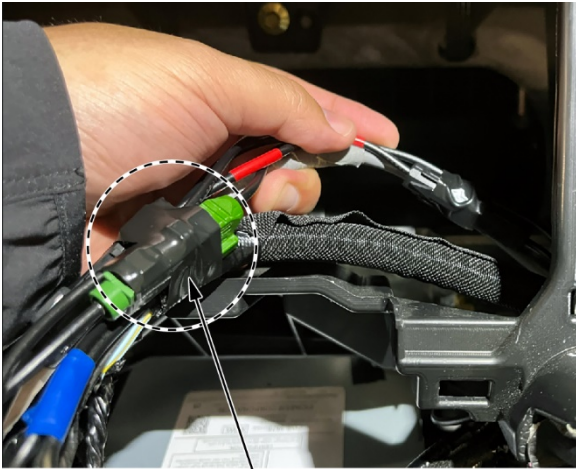

TAPE

17. Tape the FAKRA splice repair service cable harness to the vehicle harness at the lower dash.



TAPE

18. Tape the FAKRA splice repair service cable harness to the dash harness.

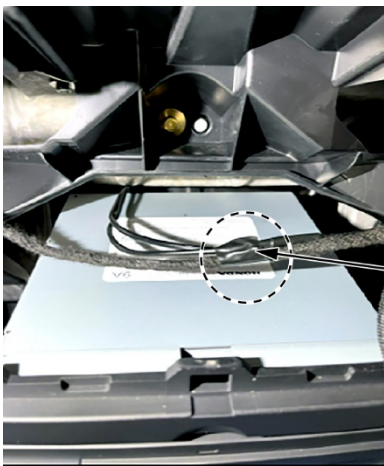

Tape together.

19. Skip to **step 41** in this section.

**CD Player P/N 08A06-TG7-100C (FAKRA Connector Lock Tabs Pointing Up at 12 O'clock)
Attachment Kit 08A06-TG7-110B (Includes Straight Connectors)**

**Cable Connection Layout for Accessory CD Player P/N 08A06-TG7-100B
With Attachment Kit 08A06-TG7-110B (Includes Straight Connectors)**

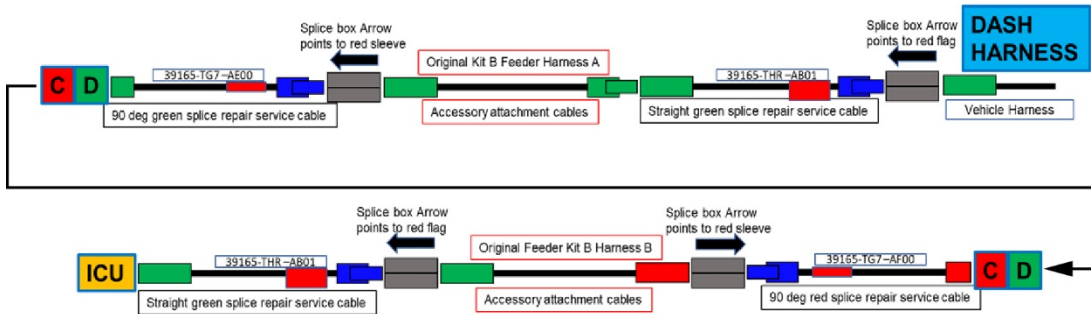

20. With the CD player removed in the **PILOT – TRIM REMOVAL PROCEDURE** section, determine if the CD player is **08A06-TG7-100C** (FAKRA connector lock tabs pointing up at 12 o'clock).
21. Take a clear photo of the accessory CD player label located on the top of the CD player.

NOTE:

- In order for the warranty claim to be processed and your warranty administrator to be able to select the right template, you will need to include the photo of the CD label that includes the **serial number and the part number** when the claim is submitted.
- Be sure to protect the center console and surrounding interior surfaces when working on the CD player.

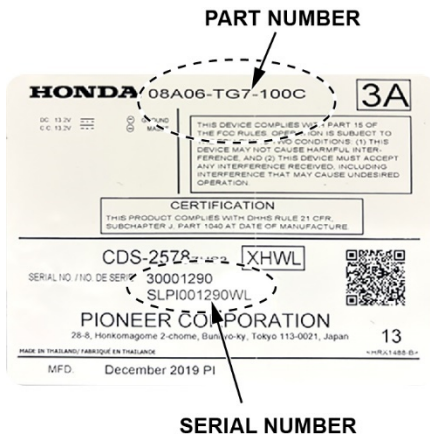

22. Disconnect the red and green accessory attachment cables from the CD player, and the Infotainment Control unit then remove them from the dash.

Kit B GREEN CABLE ASSEMBLY PROCEDURE (Attachment Kit 08A06-TG7-110B)

23. Connect the green 90° FAKRA splice repair service cable to the green accessory attachment cable with a splice box.

NOTE:

- See the above section **FAKRA CONNECTOR HOUSING DISASSEMBLY/FAKRA SPLICE REPAIR SERVICE CABLE ASSEMBLY PROCEDURE SECTION** for detailed instructions.
- If any of the lock tabs break during installation, the splice box half(s) must be replaced.
- If the splice box is installed **incorrectly**, the repair **will fail**; MOST Ring failure conditions will still occur.

24. Plug in the green accessory attachment cable into green FAKRA splice repair service cable.

NOTE: **Steps 24–31** are performed on the bench for best results.



25. Connect the red 90° FAKRA splice repair service cable to the red side of the (green/red) accessory attachment cable with a splice box.

26. Connect the green side of the (green/red) accessory attachment cable to the green FAKRA splice repair service cable with a splice box.

NOTE:

- See the above section **FAKRA CONNECTOR HOUSING DISASSEMBLY/FAKRA SPLICE REPAIR SERVICE CABLE ASSEMBLY PROCEDURE SECTION** for detailed instructions.
- If any of the lock tabs break during installation, the splice box half(s) must be replaced.
- If the splice box is installed **incorrectly**, the repair **will fail**; MOST Ring failure conditions will still occur.
- Unlike the other FAKRA splice boxes, the ones used in the following steps (**and only these steps**) point in the opposite direction of each other.

27. With the green and red 90° FAKRA splice repair service cables facing the same direction, tape the cables together at the midpoint between the two attached splice boxes and the 90° connectors.

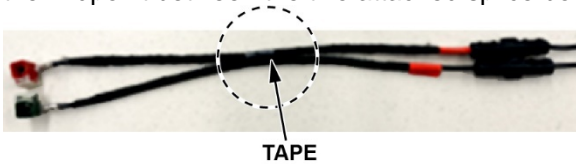

28. Tape both splice boxes that connect the green and red 90° FAKRA splice repair service cables to the green, and green/red accessory attachment cables.



29. Tape the accessory attachment cables together at the midpoint between the two attached 90° splice boxes and the single splice box attached on the green cable.



30. Tape the green cable to the single splice box attaching the (green/red) accessory attachment cable to the green FAKRA splice repair cable.

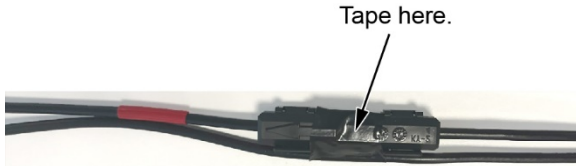

31. Tape the red cable to the green accessory attachment cable.

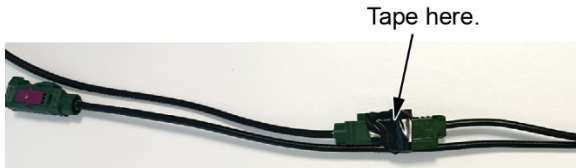

32. Connect the green FAKRA splice repair service cable and splice box to the vehicle dash harness.

NOTE:

- See the above section **FAKRA CONNECTOR HOUSING DISASSEMBLY/FAKRA SPLICE REPAIR SERVICE CABLE ASSEMBLY PROCEDURE SECTION** for detailed instructions.
- If any of the lock tabs break during installation, the splice box halve(s) must be replaced.
- If the splice box is installed **incorrectly**, the repair **will fail**; MOST Ring failure conditions will still occur.

33. Connect the green FAKRA splice repair service cable to the Infotainment Control Unit.

34. Route the taped FAKRA splice repair service cables through the right side of the vehicle dash.



35. Reconnect the 90° FAKRA connectors and any other related connectors to the CD player.

36. Position the CD unit into its mounting position.

37. Pull the excess cables up toward the Infotainment Control Unit.

NOTE: Be sure to leave some slack at the CD player connections.

38. Tape both splice boxes, green connector and cables to the Infotainment Control Unit harness as shown.

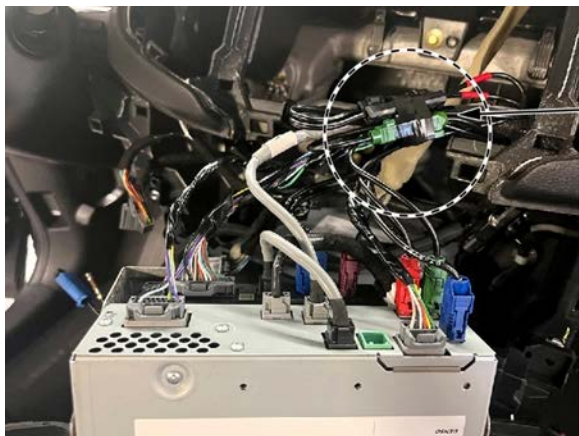

Tape both splice boxes, green connector and cables to the infotainment control unit.

39. Tape the FAKRA Splice repair service cable harness to the vehicle harness at lower dash.



TAPE

40. Tape the 90 deg splice boxes and FAKRA Splice repair service cable harness to the dash harness.



TAPE

41. Using the digital borescope (T/N BK5600DUAL55) or a commercially available borescope with multiple view angles, inspect the cable routing at the back of the gauge control module as shown below to make sure the cables are routed straight and not sideloaded. Adjust gauge control module harness as needed to achieve proper cable routing.



BORESCOPE

CORRECT ✓

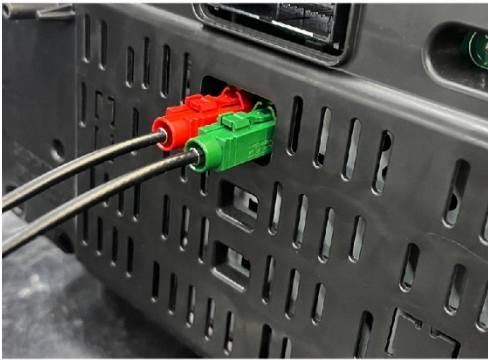

INCORRECT ✗

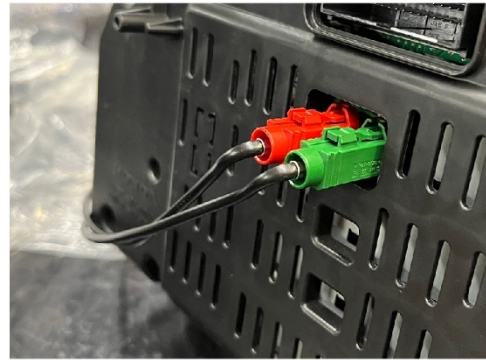

42. Once you have confirmed the cable routing is correct, install the Infotainment Control Unit mounting screws.

PILOT – CENTER CONSOLE IN-LINE CONNECTOR REPAIR PROCEDURE

1. Disconnect the blue FAKRA connector at the passenger side center console.

FAKRA CONNECTOR



2. Install the matching color FAKRA splice repair service cable and splice box.

NOTE:

- See the above section **FAKRA CONNECTOR HOUSING DISASSEMBLY/FAKRA SPLICE REPAIR SERVICE CABLE ASSEMBLY PROCEDURE SECTION** for detailed instructions.
- **The splice box arrow must always point in the direction of the red flag label or red sleeve on the FAKRA splice repair service cable.**
- If any of the lock tabs break during installation, the splice box halve(s) must be replaced.
- If the splice box is installed **incorrectly**, the repair **will fail**; MOST Ring failure conditions will still occur.

3. Tape both the splice box and cable to the in-line harness.



Keep smooth curves
with a radius bend
greater than 25mm.

Attach FAKRA service cables and splice boxes to the appropriate component harness with tape to prevent any rattles.

4. Reconnect the blue in-line FAKRA connector.

PILOT – PASSENGER KICK PANEL IN-LINE CONNECTOR REPAIR PROCEDURE

1. Disconnect the blue FAKRA connector at the passenger side kick panel.

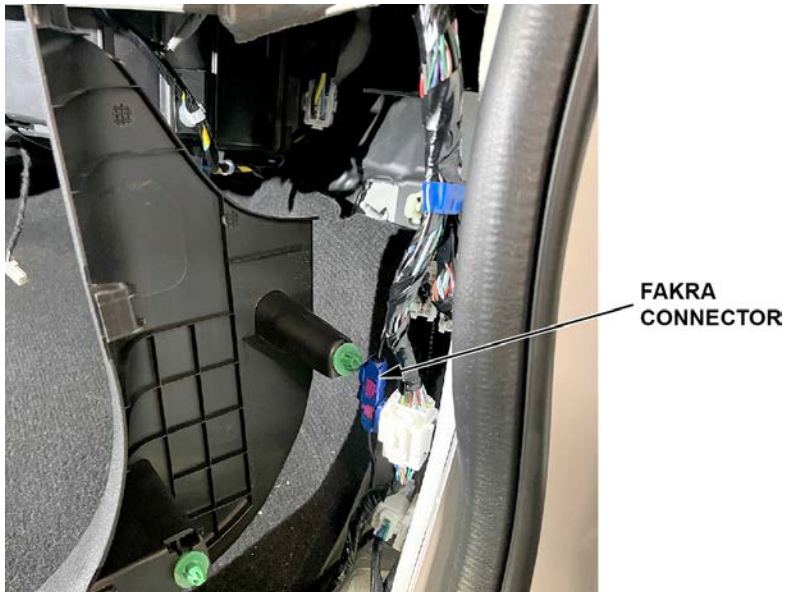

2. Install the matching color FAKRA splice repair service cable and splice box.

NOTE:

- See the above section **FAKRA CONNECTOR HOUSING DISASSEMBLY/FAKRA SPLICE REPAIR SERVICE CABLE ASSEMBLY PROCEDURE SECTION** for detailed instructions.
 - **The splice box arrow must always point in the direction of the red flag label or red sleeve on the FAKRA splice repair service cable.**
 - If any of the lock tabs break during installation, the splice box halve(s) must be replaced.
 - If the splice box is installed **incorrectly**, the repair **will fail**; MOST Ring failure conditions will still occur.
3. Tape the splice box and cable to the in-line harness.

Keep smooth curves with radius bend greater than 25mm.

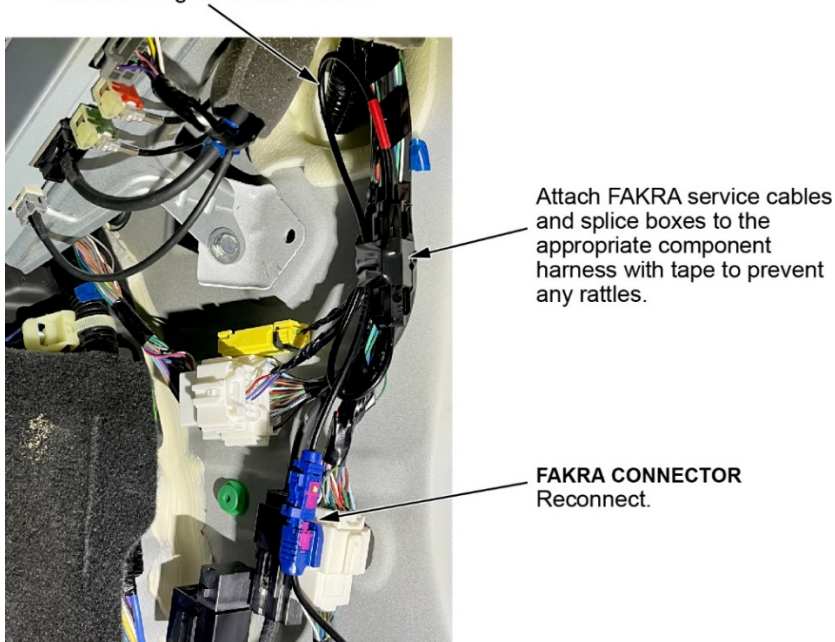

4. Reconnect the blue in-line FAKRA connector.

PILOT – TUNER UNIT REPAIR PROCEDURE

1. Disconnect the red and green FAKRA connectors at the tuner unit.

NOTE: Disassemble the connectors one at a time to avoid swapping the green and red wires.

FAKRA CONNECTORS



2. Install the matching color FAKRA splice repair service cables and splice box.

NOTE:

- See the above section **FAKRA CONNECTOR HOUSING DISASSEMBLY/FAKRA SPLICE REPAIR SERVICE CABLE ASSEMBLY PROCEDURE SECTION** for detailed instructions.
- **The splice box arrow must always point in the direction of the red flag label or red sleeve on the FAKRA splice repair service cable.**
- If any of the lock tabs break during installation, the splice box halve(s) must be replaced.
- If the splice box is installed **incorrectly**, the repair **will fail**; MOST Ring failure conditions will still occur.

3. Tape both splice boxes and cables to the tuner unit harness.

FAKRA CONNECTORS



Attach the FAKRA service cables and splice boxes to the appropriate component harness with tape to prevent any rattles.

Keep smooth curves with a radius bend greater than 25 mm.

PILOT – FINISHING REPAIR PROCEDURE

1. Install all of the removed parts in the reverse order of removal.

NOTE:

- When reinstalling components, make sure the harness is routed correctly. A **misrouted harness** can put pressure on the wires and connectors, causing connection issues.
 - **Do not pull** on the units or MOST cables while the FAKRA connectors are connected to help prevent communication issues.
2. Start the vehicle and verify gauge control module and infotainment control unit operates normally, push the power button OFF, open and close the driver's door and restart the vehicle reverify gauge control module, infotainment control unit operates normally. If all systems operate normally, the repair is complete.
 3. If components do not operate as intended, reinspect FAKRA Splice repair service cables, splice box connections, and routing. Make sure the splice box arrow is pointing to the red flag label or red sleeve on the FAKRA Splice box service cable.

NOTE: If all FAKRA splice repair service cables, splice box connections, and routing are correct, follow normal troubleshooting procedures per System Information Search on iN.

PASSPORT – TRIM REMOVAL PROCEDURE

1. Remove the side cover.



2. Loosen the upper column cover.



3. Remove the lower dash panel.

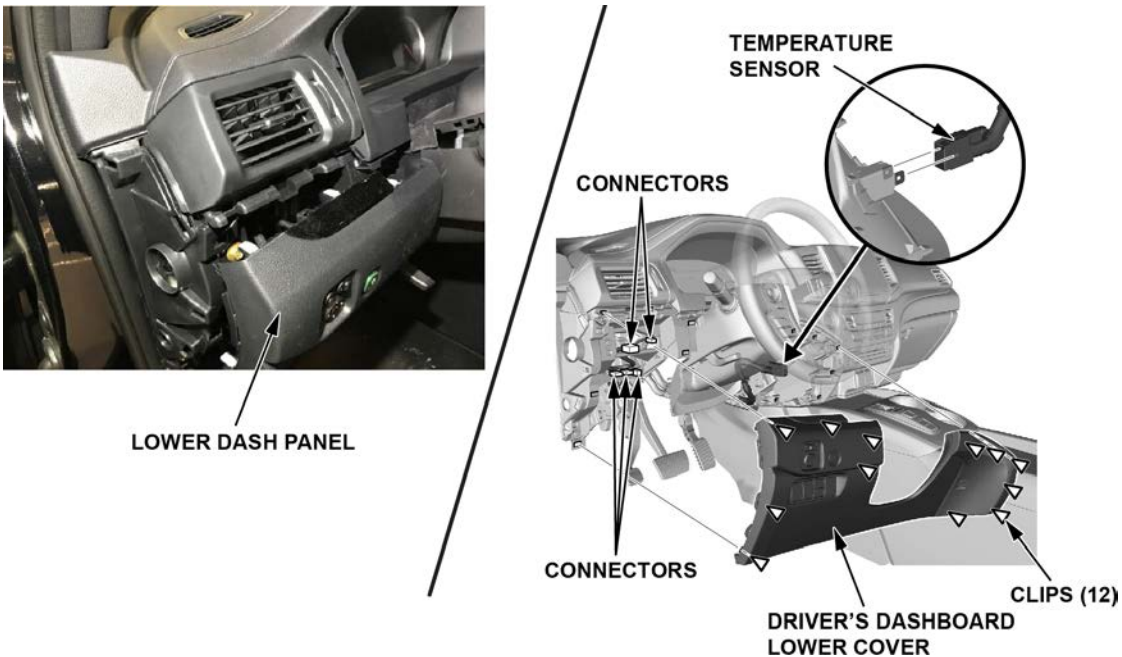

4. Pull back the dash panel to allow meter bezel removal.



5. Remove the meter bezel and upper column cover as one piece.

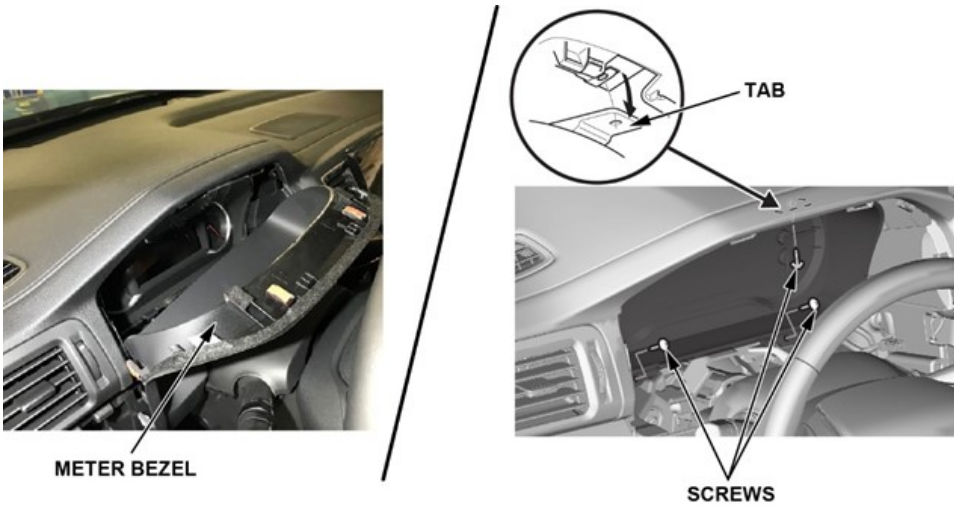

6. Remove the Infotainment Control Unit.

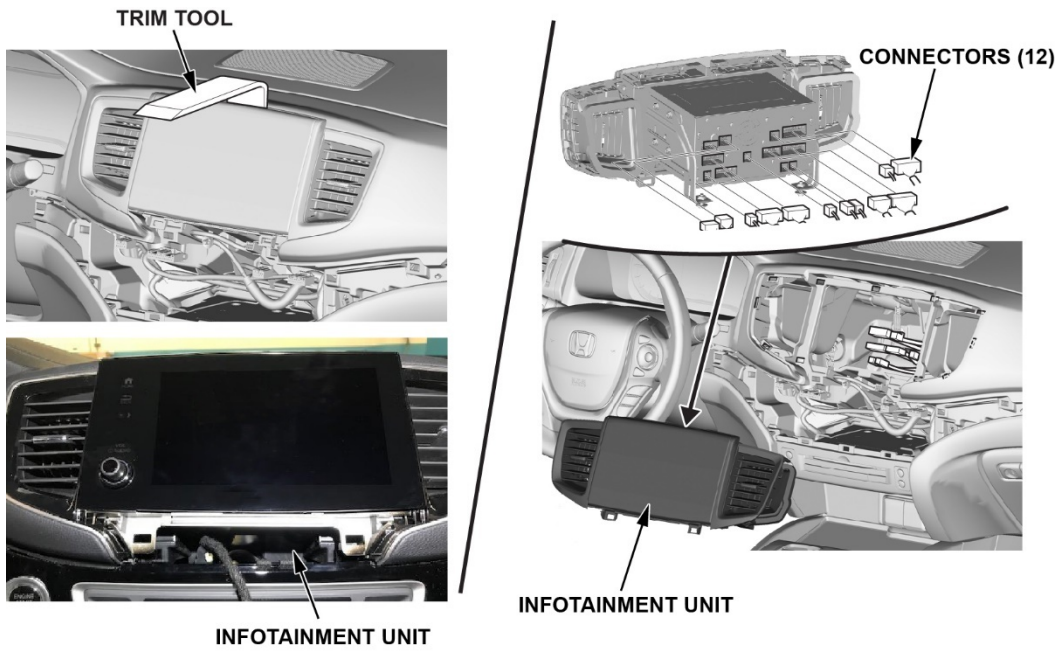

7. Remove the passenger trim dashboard panel.

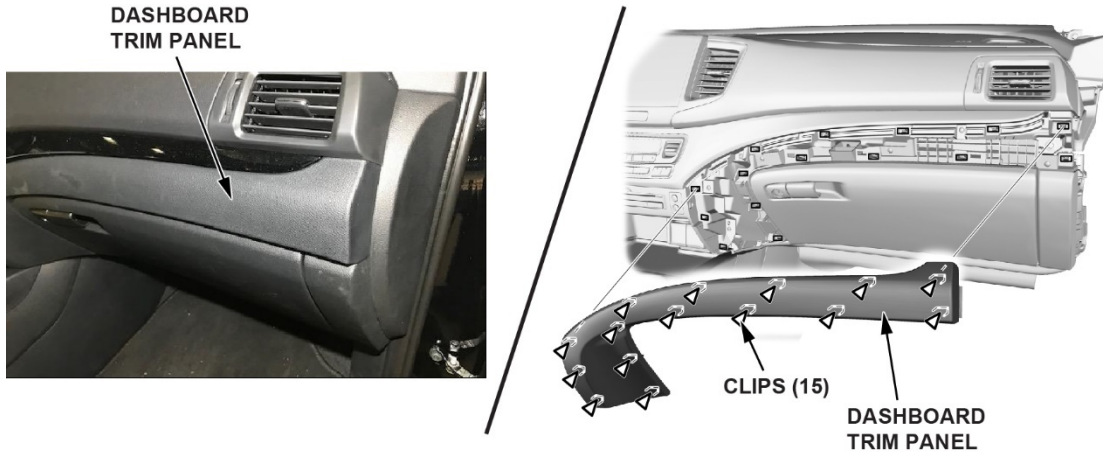

8. Remove the dashboard center middle trim.



DASHBOARD CENTER MIDDLE TRIM



SCREWS

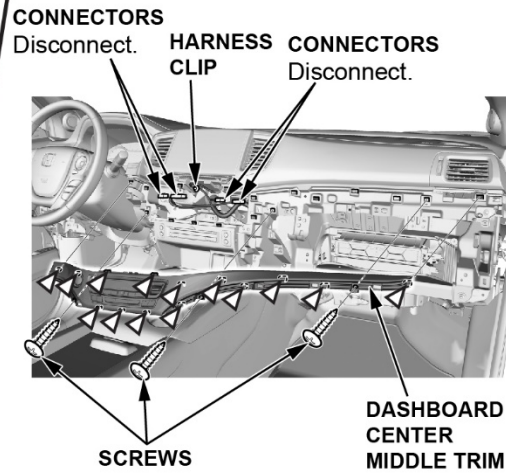

9. Remove the dashboard center panel.

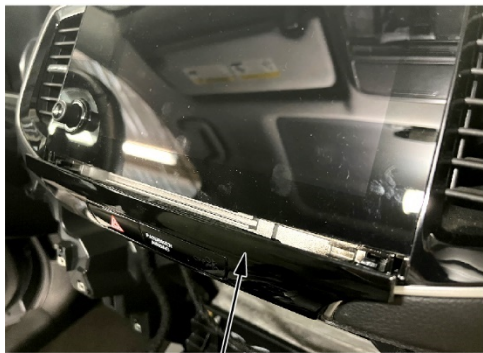

DASHBOARD CENTER PANEL

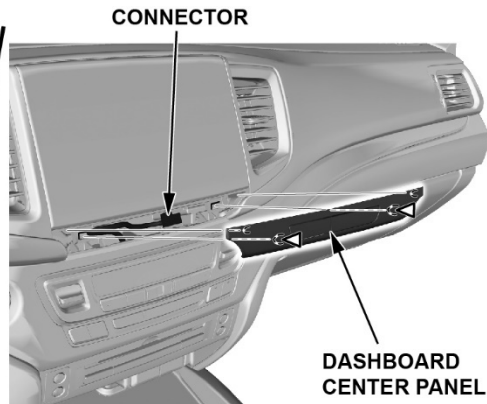

10. Remove the screws and bolts, then remove the dashboard center lower panel or if installed, the accessory CD player.

NOTE:

- Some trim levels may have an accessory CD player installed, see **PASSPORT – ACCESSORY CD PLAYER REPAIR PROCEDURE**.
- Make sure to protect the center console and the surrounding surfaces.

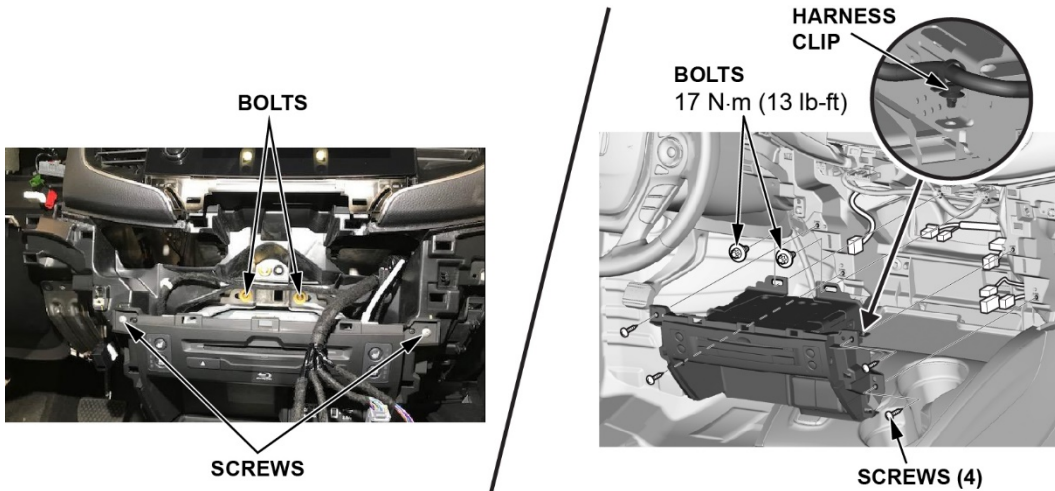

11. Loosen the two bolts holding the Infotainment Control Unit and then, remove the unit.

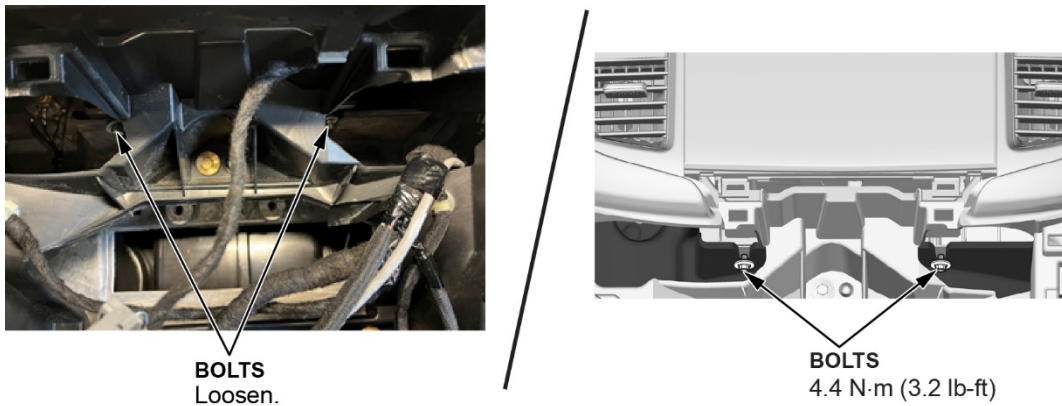

12. Remove the passenger side center console side cover.

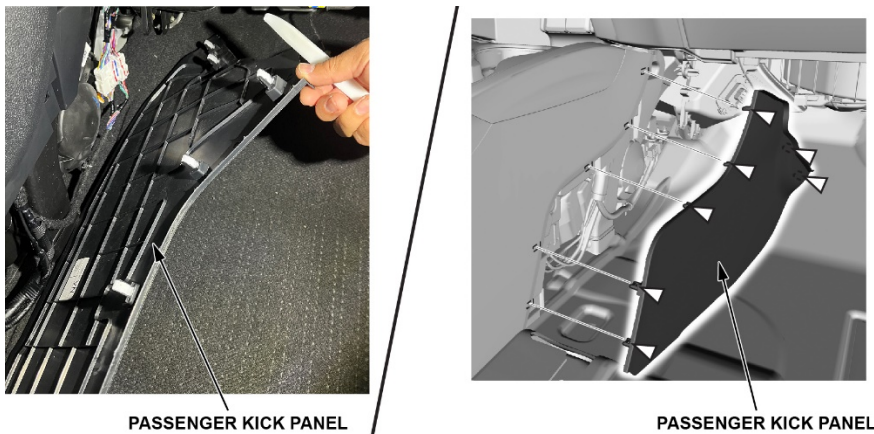

13. Remove the rear cargo cover, cargo tray, rear panel, and spare tire.

NOTE:

- For **EX** and **EX-L** trim levels, go to the **PASSPORT – GAUGE CONTROL MODULE REPAIR PROCEDURE**.
- For **Touring**, **Elite**, and **Black Edition** continue to the **next step**.

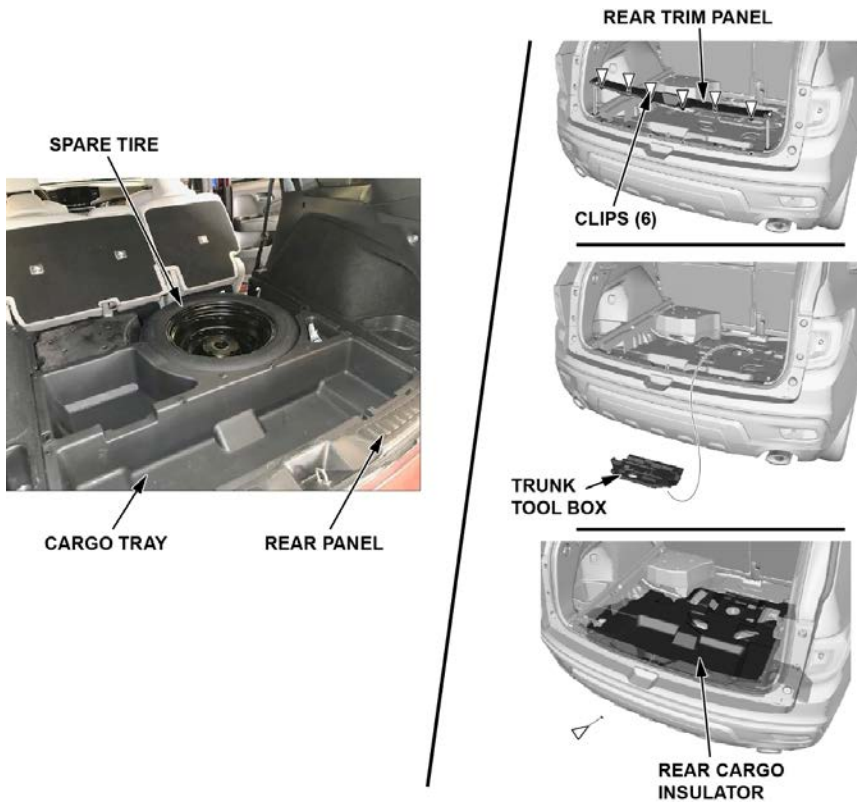

14. Remove the rear passenger door trim.

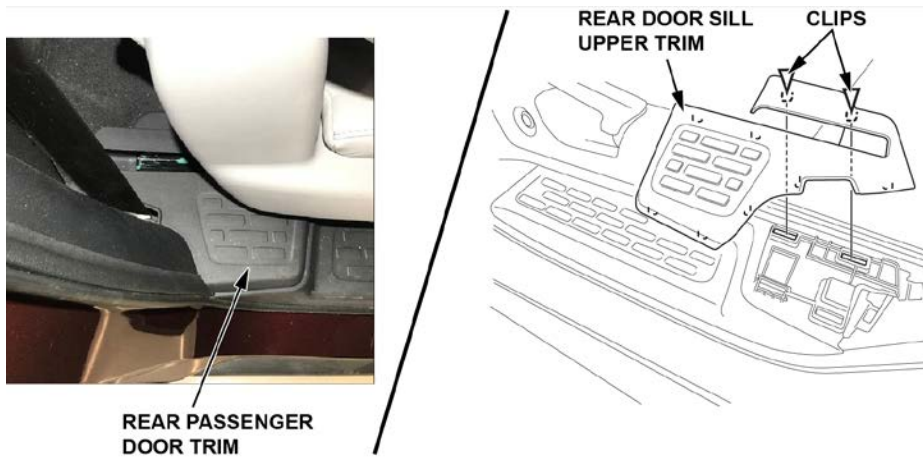

15. Remove the right rear quarter panel.

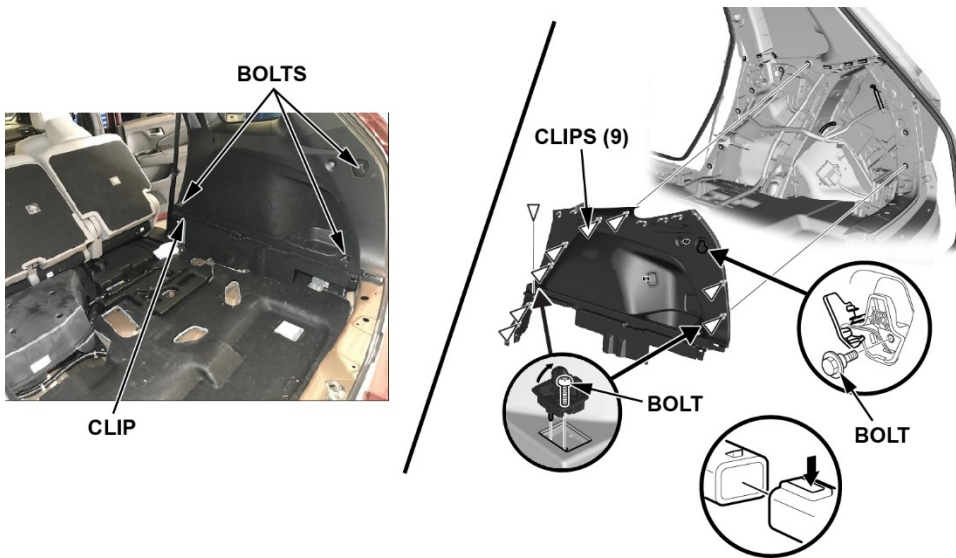

PASSPORT – GAUGE CONTROL MODULE REPAIR PROCEDURE

1. Locate and turn the gauge control module to access the rear connectors.



**GAUGE
CONTROL
MODULE**

2. Disconnect the red and green FAKRA connectors and any other related connectors from the gauge control module.



**FAKRA
CONNECTORS**

3. If the WPC FAKRA service housings and extension cables are installed, you must un-tape the WPC connectors and extension cables from the vehicle harness.

Untape.

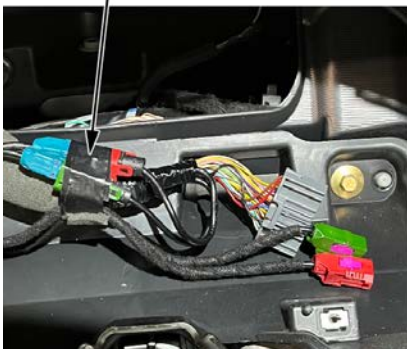

Disconnect.

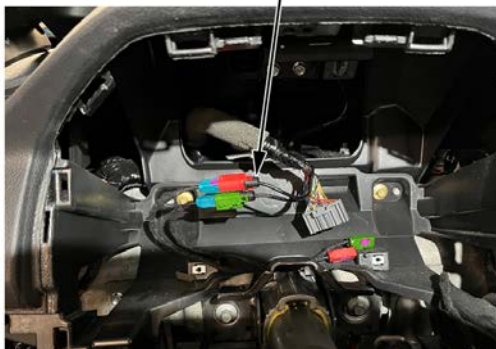

4. Remove the extension cables and then, discard.

NOTE: Disassemble the connectors one at a time to avoid swapping the green and red wires.

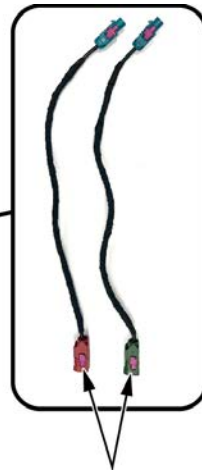
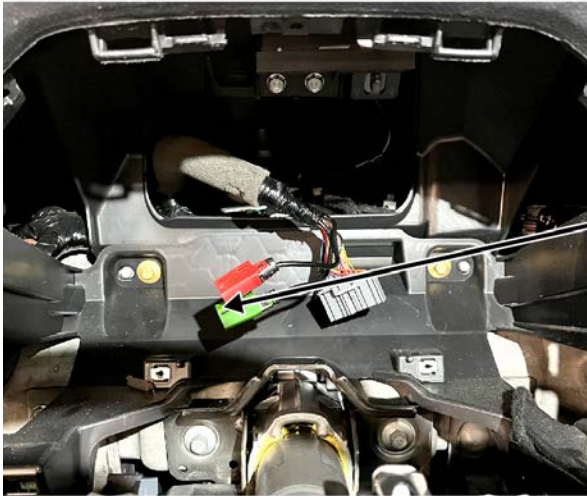

EXTENSION CABLES
Remove and discard.

5. Install the matching color FAKRA splice repair service cables and splice boxes.

NOTE:

- See the above section **FAKRA CONNECTOR HOUSING DISASSEMBLY/FAKRA SPLICE REPAIR SERVICE CABLE ASSEMBLY PROCEDURE SECTION** for detailed instructions.
- **The splice box arrow must always point in the direction of the red flag label or red sleeve on the FAKRA splice repair service cable.**
- If any of the lock tabs break during installation, the splice box halve(s) must be replaced.
- If the splice box is installed **incorrectly**, the repair **will fail**; MOST Ring failure conditions will still occur.

Attach FAKRA service cables and splice boxes to the appropriate component harness with tape to prevent any rattles.



Keep smooth curves with a radius bend greater than 25 mm.

6. Reconnect the FAKRA connectors and any other related connectors to the gauge control module.
7. Install the gauge control module into its mounting position.

8. Using the digital borescope (T/N BK5600DUAL55) or a commercially available borescope with multiple view angles, inspect the cable routing at the back of the gauge control module as shown below to make sure the cables are routed straight and not sideloaded. Adjust gauge control module harness as needed to achieve proper cable routing.

LEFT SIDE

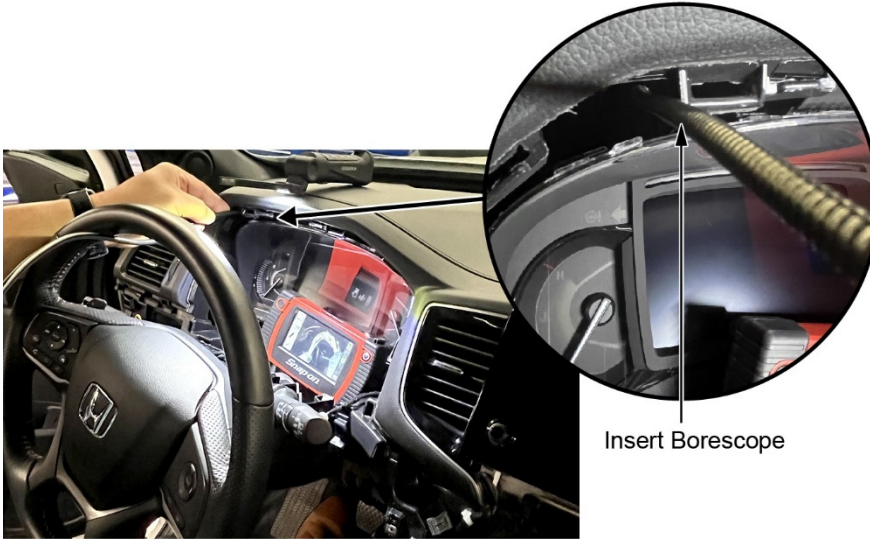

RIGHT SIDE

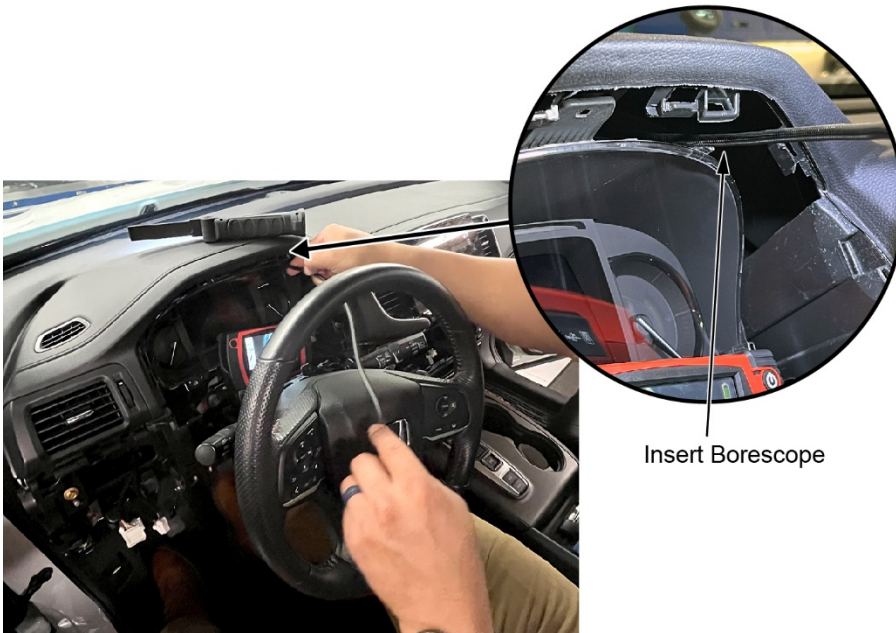

CORRECT ✓

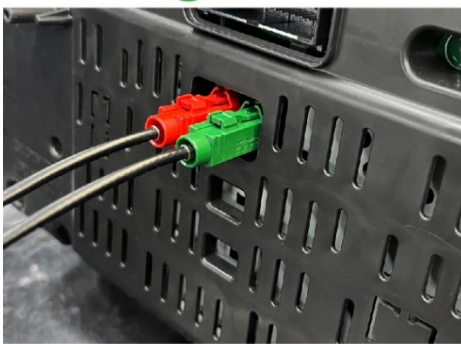

INCORRECT ✗

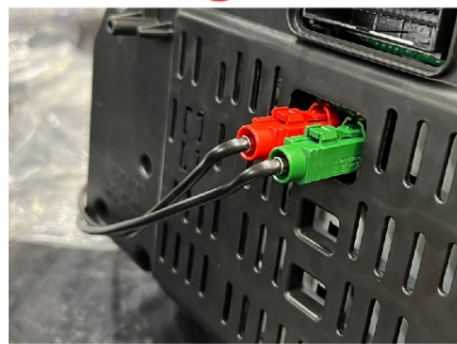

9. Once you have confirmed the cable routing is correct, install the control gauge module mounting screws.

PASSPORT – INFOTAINMENT CONTROL UNIT REPAIR PROCEDURE

1. Remove the Infotainment Control Unit.
2. Disconnect the red and green FAKRA connectors and any other related connectors at the Infotainment Control Unit.

NOTE:

- Make sure to protect the center console and the surrounding surfaces when working on the Infotainment Control Unit.
- Disassemble the connectors one at a time to avoid swapping the green and red wires.
- Begin the **PASSPORT – ACCESSORY CD PLAYER REPAIR PROCEDURE** if a CD player is present.
- **If not**, proceed to the **next step**.

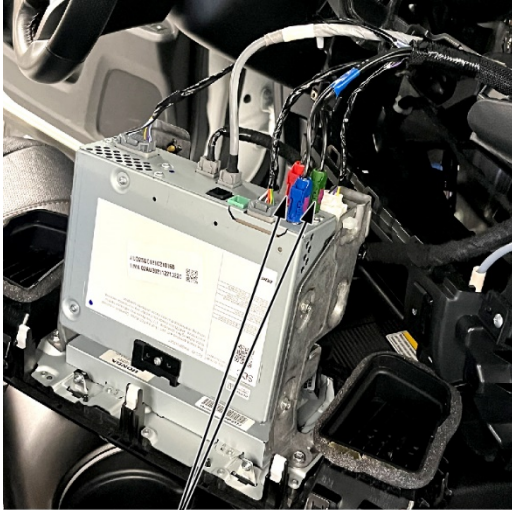

FAKRA CONNECTORS

3. Install the matching color FAKRA splice repair service cables and splice boxes.

NOTE:

- See the above section **FAKRA CONNECTOR HOUSING DISASSEMBLY/FAKRA SPLICE REPAIR SERVICE CABLE ASSEMBLY PROCEDURE SECTION** for detailed instructions.
- **The splice box arrow must always point in the direction of the red flag label or red sleeve on the FAKRA splice repair service cable.**
- If any of the lock tabs break during installation, the splice box half(s) must be replaced.
- If the splice box is installed **incorrectly**, the repair **will fail**; MOST Ring failure conditions will still occur.
- Make sure the screen is protected during the repair.

4. Tape both splice boxes and cables to the Infotainment Control Unit harness.

Keep smooth curves with a radius bend greater than 25 mm.



Attach FAKRA service cables and splice boxes to the appropriate component harness with tape to prevent any rattles.

5. Reconnect the FAKRA connectors and any other related connectors to the Infotainment Control Unit.
6. Install the Infotainment Control Unit into its mounting position.
7. Using the digital borescope (T/N BK5600DUAL55) or a commercially available borescope with multiple view angles, inspect the cable routing at the back of the gauge control module as shown below to make sure the cables are routed straight and not sideloaded. Adjust gauge control module harness as needed to achieve proper cable routing.



Insert borescope.



BORESCOPE

CORRECT ✓



INCORRECT ✗

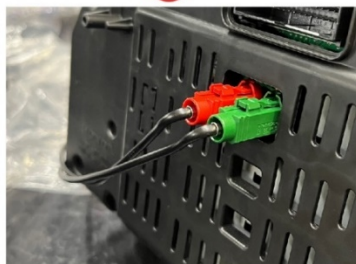

8. Once you have confirmed the cable routing is correct, install the Infotainment Control Unit mounting screws.

PASSPORT – ACCESSORY CD PLAYER REPAIR PROCEDURE

CD Player P/N 08A06-TG7-100E (FAKRA Connector Lock Tabs Pointing Down at 6 O'clock)
Attachment Kit 08A06-TG7-110F (Includes 90° Connectors)

Cable Connection Layout for Accessory CD Player P/N 08A06-TG7-100E With Attachment Kit 08A06-TG7-110F (Include 90° Connectors)

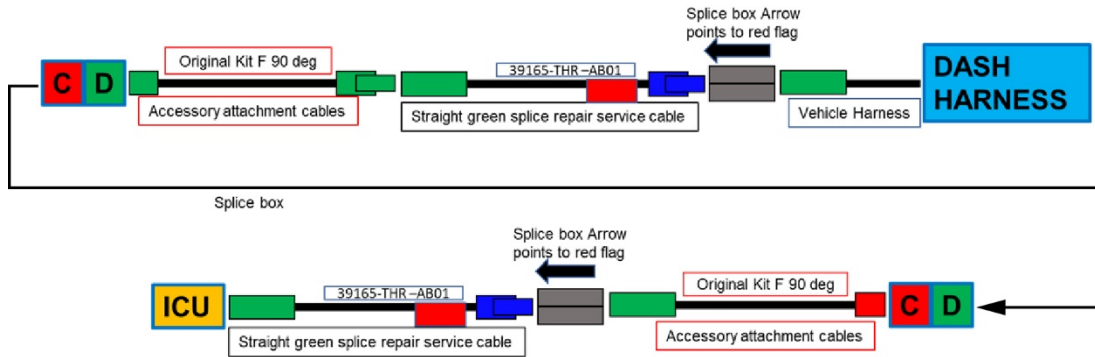

1. With the CD player removed in the **PASSPORT – TRIM REMOVAL PROCEDURE** section, determine if the CD player P/N is **08A06-TG7-100E** (FAKRA connector lock tabs pointing down at 6 o'clock). **If not**, proceed to **step 20**.
2. Take a clear photo of the Accessory CD player label located on the top of the CD player.

NOTE:

- In order for the warranty claim to be processed and your warranty administrator to be able to select the right template, you will need to include the photo of the CD label that includes the **serial number** and the **part number** when the claim is submitted.
- Be sure to protect the center console and surrounding interior surfaces when working on the CD player

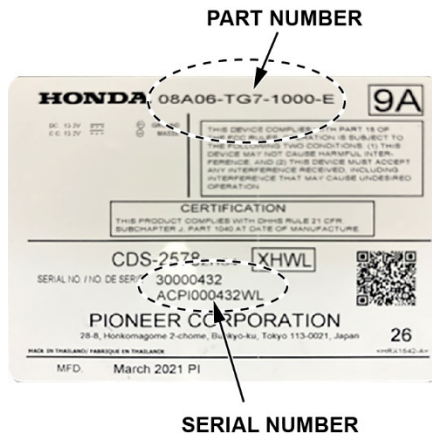

3. Disconnect the red and green 90° accessory attachment cables from the CD player, and the Infotainment Control Unit. Then, remove them from the dash.

NOTE: Disassemble the connectors one at a time to avoid swapping the green and red wires.

Kit F GREEN CABLE ASSEMBLY PROCEDURE (Attachment Kit 08A06-TG7-110F)

4. Plug in the green 90 deg accessory attachment cable into the green FAKRA Splice repair service cable.

NOTE: **Steps 4–8** are performed on the bench for best results.

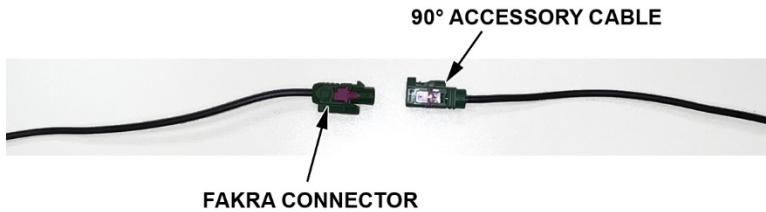

Kit F RED CABLE ASSEMBLY PROCEDURE (Attachment Kit 08A06-TG7-110F)

5. Connect the red 90 deg accessory attachment cable to the green FAKRA Splice repair service cable with the splice box.

NOTE:

- See the above section **FAKRA CONNECTOR HOUSING DISASSEMBLY/FAKRA SPLICE REPAIR SERVICE CABLE ASSEMBLY PROCEDURE SECTION** for detailed instructions.
 - If any of the lock tabs break during installation, the splice box halve(s) must be replaced.
 - If the splice box is installed **incorrectly**, the repair **will fail**; MOST Ring failure conditions will still occur.
6. With the green and red 90° accessory attachment cable connectors facing the same direction, tape the cables together at the halfway point between the 90° connectors and the splice box.



7. Tape the green 90° accessory attachment cable to the splice box.



8. Tape the red 90° accessory attachment cable to the green connector.



9. Connect the green FAKRA splice repair service cable and splice box to the vehicle dash harness green connector cable.

NOTE:

- See the above section **FAKRA CONNECTOR HOUSING DISASSEMBLY/FAKRA SPLICE REPAIR SERVICE CABLE ASSEMBLY PROCEDURE SECTION** for detailed instructions.
 - If any of the lock tabs break during installation, the splice box halve(s) must be replaced.
 - If the splice box is installed **incorrectly**, the repair **will fail**; MOST Ring failure conditions will still occur.
10. Reconnect the green and red FAKRA connectors and any other related connectors to the Infotainment Control Unit.

11. Route the taped FAKRA splice repair service cables through the right side of the vehicle dash.



12. Connect the green and red 90° connectors to the CD player.

13. Position the CD unit into its mounting position.

14. Pull the excess cables up toward the Infotainment Control Unit.

NOTE: Make sure to leave some slack at the CD player connections.

15. Tape the splice box, the green connector, and the cables to the Infotainment Control Unit harness.

Keep smooth curves
with a radius bend
greater than 25mm.



Attach Fakra service cables and splice boxes to the appropriate component harness with tape to prevent any rattles.

16. Tape the splice box to the Infotainment Control Unit harness.

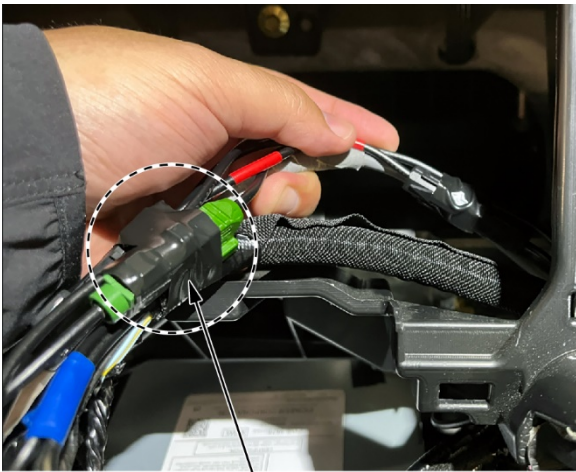

TAPE

17. Tape the FAKRA splice repair service cable harness to the vehicle harness at the lower dash.



TAPE

18. Tape the FAKRA splice repair service cable harness to the dash harness.

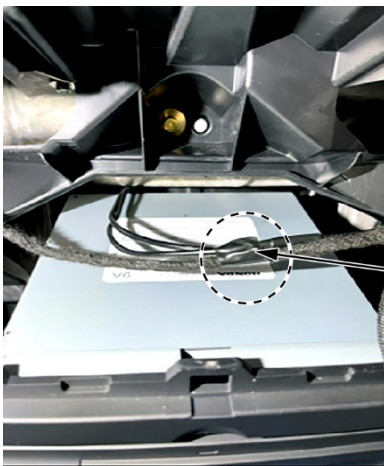

Tape together.

19. Skip to **step 41** in this section.

**CD Player P/N 08A06-TG7-100C (FAKRA Connector Lock Tabs Pointing Up at 12 O'clock)
Attachment Kit 08A06-TG7-110B (Includes Straight Connectors)**

**Cable Connection Layout for Accessory CD Player P/N 08A06-TG7-100B
With Attachment Kit 08A06-TG7-110B (Includes Straight Connectors)**

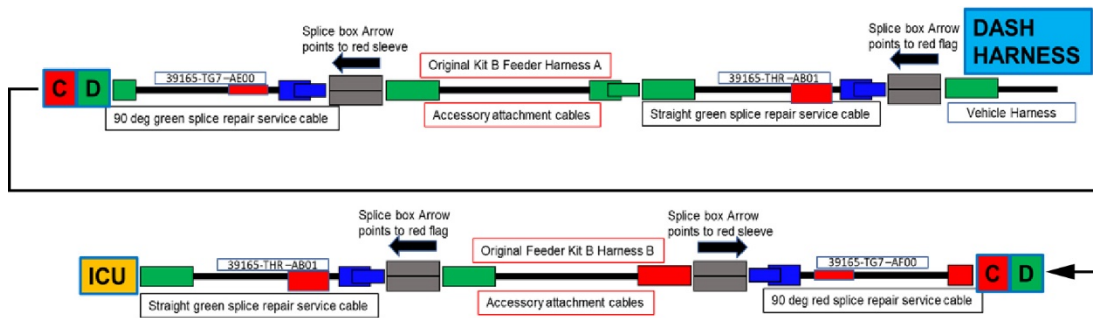

20. With the CD player removed in the **PASSPORT – TRIM REMOVAL PROCEDURE** section, determine if the CD player is **08A06-TG7-100C** (FAKRA connector lock tabs pointing up at 12 o'clock).

21. Take a clear photo of the accessory CD player label located on the top of the CD player.

NOTE:

- In order for the warranty claim to be processed and your warranty administrator to be able to select the right template, you will need to include the photo of the CD label that includes the **serial number and the part number** when the claim is submitted.
- Be sure to protect the center console and surrounding interior surfaces when working on the CD player.

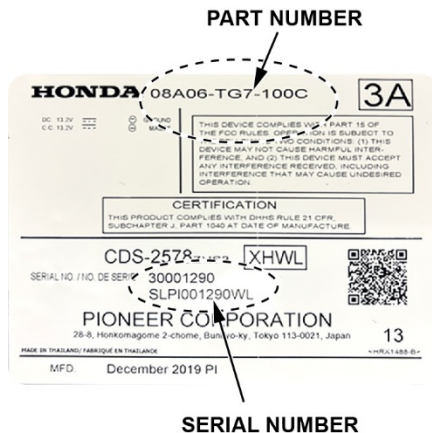

22. Disconnect the red and green accessory attachment cables from the CD player, and the Infotainment Control unit then remove them from the dash.

Kit B GREEN CABLE ASSEMBLY PROCEDURE (Attachment Kit 08A06-TG7-110B)

23. Connect the green 90° FAKRA splice repair service cable to the green accessory attachment cable with a splice box.

NOTE:

- See the above section **FAKRA CONNECTOR HOUSING DISASSEMBLY/FAKRA SPLICE REPAIR SERVICE CABLE ASSEMBLY PROCEDURE SECTION** for detailed instructions.
- If any of the lock tabs break during installation, the splice box halve(s) must be replaced.
- If the splice box is installed **incorrectly**, the repair **will fail**; MOST Ring failure conditions will still occur.

24. Plug in the green accessory attachment cable into green FAKRA splice repair service cable.

NOTE: **Steps 24–31** are performed on the bench for best results.



25. Connect the red 90° FAKRA splice repair service cable to the red side of the (green/red) accessory attachment cable with a splice box.

26. Connect the green side of the (green/red) accessory attachment cable to the green FAKRA splice repair service cable with a splice box.

NOTE:

- See the above section **FAKRA CONNECTOR HOUSING DISASSEMBLY/FAKRA SPLICE REPAIR SERVICE CABLE ASSEMBLY PROCEDURE SECTION** for detailed instructions.
- If any of the lock tabs break during installation, the splice box half(s) must be replaced.
- If the splice box is installed **incorrectly**, the repair **will fail**; MOST Ring failure conditions will still occur.
- Unlike the other FAKRA splice boxes, the ones used in the following steps (**and only these steps**) point in the opposite direction of each other.

27. With the green and red 90° FAKRA splice repair service cables facing the same direction, tape the cables together at the midpoint between the two attached splice boxes and the 90° connectors.

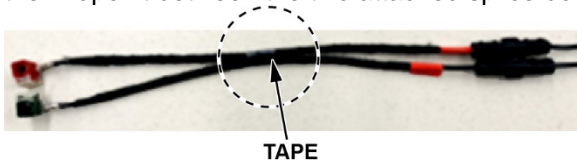

28. Tape both splice boxes that connect the green and red 90° FAKRA splice repair service cables to the green, and green/red accessory attachment cables.



29. Tape the accessory attachment cables together at the midpoint between the two attached 90° splice boxes and the single splice box attached on the green cable.



30. Tape the green cable to the single splice box attaching the (green/red) accessory attachment cable to the green FAKRA splice repair cable.

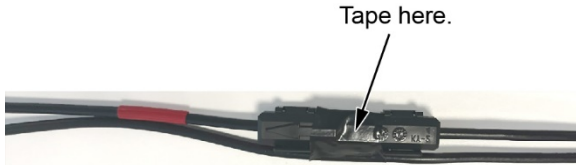

31. Tape the red cable to the green accessory attachment cable.

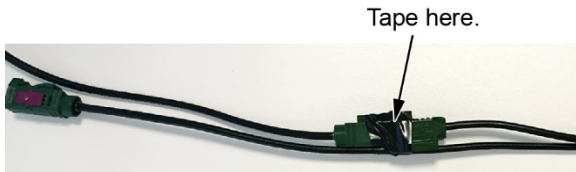

32. Connect the green FAKRA splice repair service cable and splice box to the vehicle dash harness.

NOTE:

- See the above section **FAKRA CONNECTOR HOUSING DISASSEMBLY/FAKRA SPLICE REPAIR SERVICE CABLE ASSEMBLY PROCEDURE SECTION** for detailed instructions.
- If any of the lock tabs break during installation, the splice box halve(s) must be replaced.
- If the splice box is installed **incorrectly**, the repair **will fail**; MOST Ring failure conditions will still occur.

33. Connect the green FAKRA splice repair service cable to the Infotainment Control Unit.

34. Route the taped FAKRA splice repair service cables through the right side of the vehicle dash.



35. Reconnect the 90° FAKRA connectors and any other related connectors to the CD player.

36. Position the CD unit into its mounting position.

37. Pull the excess cables up toward the Infotainment Control Unit.

NOTE: Be sure to leave some slack at the CD player connections.

38. Tape both splice boxes, green connector and cables to the Infotainment Control Unit harness as shown.

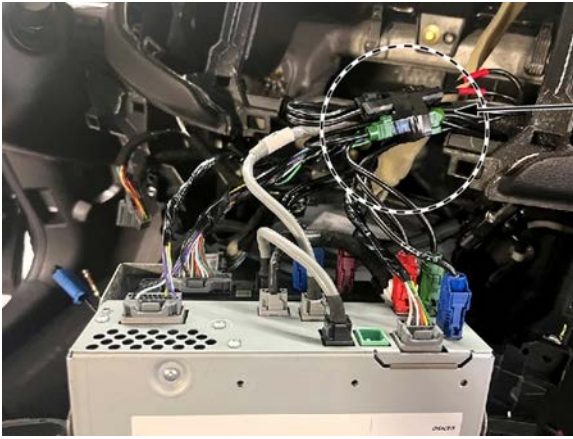

Tape both splice boxes, green connector and cables to the infotainment control unit.

39. Tape the FAKRA Splice repair service cable harness to the vehicle harness at lower dash.



TAPE

40. Tape the 90 deg splice boxes and FAKRA Splice repair service cable harness to the dash harness.



TAPE

41. Using the digital borescope (T/N BK5600DUAL55) or a commercially available borescope with multiple view angles, inspect the cable routing at the back of the gauge control module as shown below to make sure the cables are routed straight and not sideloaded. Adjust gauge control module harness as needed to achieve proper cable routing.



BORESCOPE

CORRECT ✓

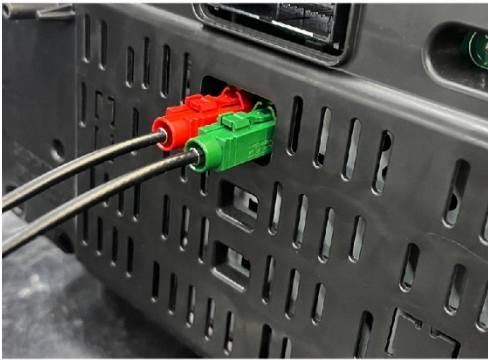

INCORRECT ✗

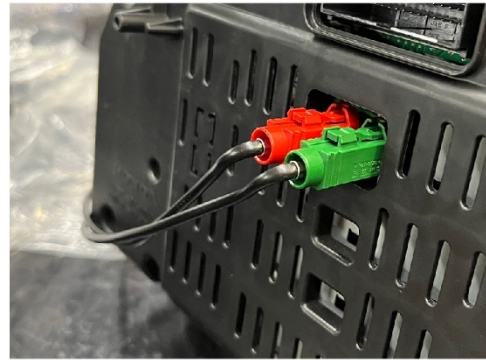

42. Once you have confirmed the cable routing is correct, install the Infotainment Control Unit mounting screws.

PASSPORT – CENTER CONSOLE IN-LINE CONNECTOR REPAIR PROCEDURE

1. Disconnect the blue FAKRA connector at the passenger side center console.

FAKRA CONNECTOR

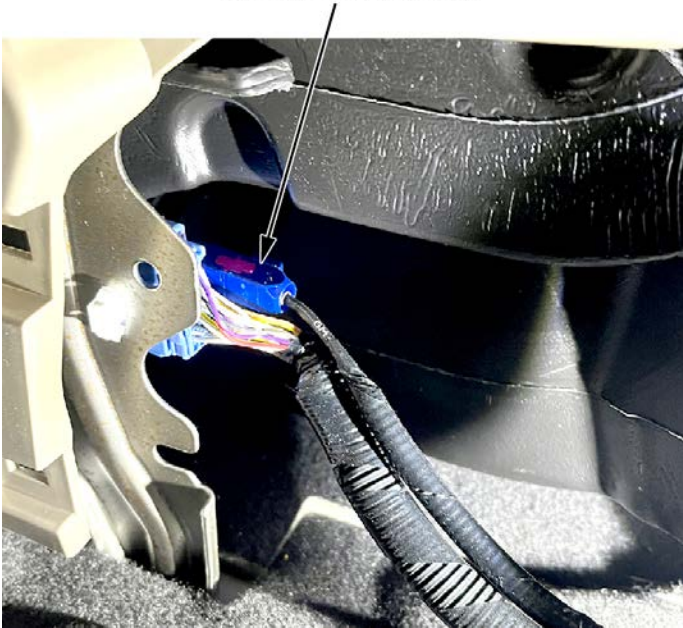

2. Install the matching color FAKRA splice repair service cable and splice box.

NOTE:

- See the above section **FAKRA CONNECTOR HOUSING DISASSEMBLY/FAKRA SPLICE REPAIR SERVICE CABLE ASSEMBLY PROCEDURE SECTION** for detailed instructions.
 - **The splice box arrow must always point in the direction of the red flag label or red sleeve on the FAKRA splice repair service cable.**
 - If any of the lock tabs break during installation, the splice box half(s) must be replaced.
 - If the splice box is installed **incorrectly**, the repair **will fail**; MOST Ring failure conditions will still occur.
3. Tape both the splice box and cable to the in-line harness.



Keep smooth curves
with a radius bend
greater than 25mm.

Attach FAKRA service cables and splice boxes to the appropriate component harness with tape to prevent any rattles.

4. Reconnect the blue in-line FAKRA connector.

PASSPORT – PASSENGER KICK PANEL IN-LINE CONNECTOR REPAIR PROCEDURE

1. Disconnect the blue FAKRA connector at the passenger side kick panel.

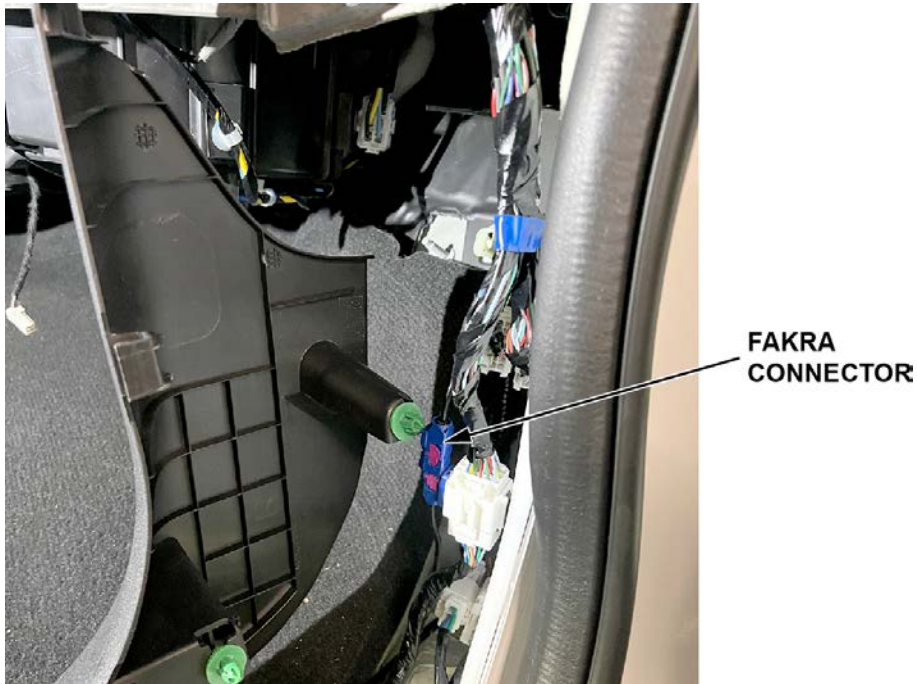

2. Install the matching color FAKRA splice repair service cables and splice box.

NOTE:

- See the above section **FAKRA CONNECTOR HOUSING DISASSEMBLY/FAKRA SPLICE REPAIR SERVICE CABLE ASSEMBLY PROCEDURE SECTION** for detailed instructions.
 - **The splice box arrow must always point in the direction of the red flag label or red sleeve on the FAKRA splice repair service cable.**
 - If any of the lock tabs break during installation, the splice box halve(s) must be replaced.
 - If the splice box is installed **incorrectly**, the repair **will fail**; MOST Ring failure conditions will still occur.
3. Tape both the splice box and cable to the in-line harness.

Keep smooth curves with radius bend greater than 25mm.

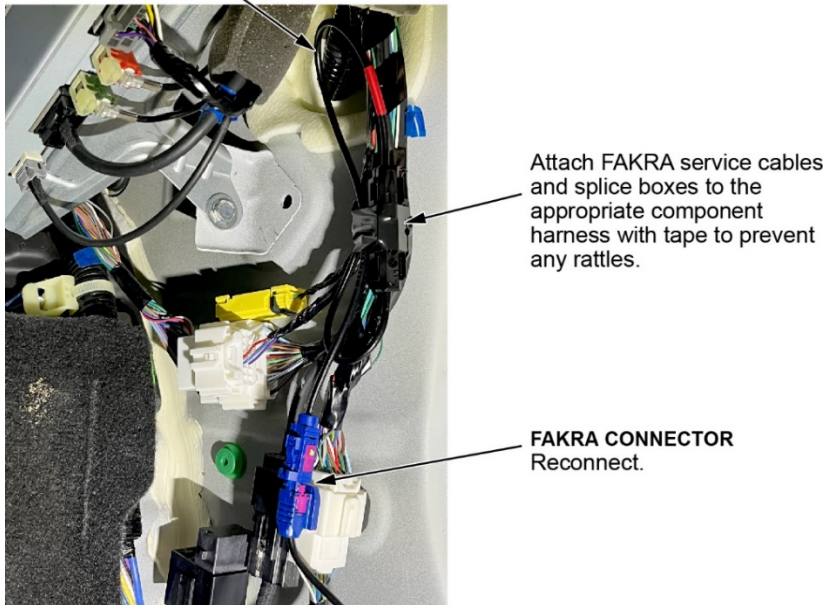

4. Reconnect the blue in-line FAKRA connector.

PASSPORT – TUNER UNIT REPAIR PROCEDURE

1. Disconnect the red and green FAKRA connectors at the tuner module.

FAKRA CONNECTORS



2. Install the matching color FAKRA splice repair service cables and splice box.

NOTE:

- See the above section **FAKRA CONNECTOR HOUSING DISASSEMBLY/FAKRA SPLICE REPAIR SERVICE CABLE ASSEMBLY PROCEDURE SECTION** for detailed instructions.
 - **The splice box arrow must always point in the direction of the red flag label or red sleeve on the FAKRA splice repair service cable.**
 - If any of the lock tabs break during installation, the splice box halve(s) must be replaced.
 - If the splice box is installed **incorrectly**, the repair **will fail**; MOST Ring failure conditions will still occur.
3. Tape both splice boxes and cables to the tuner unit harness.

FAKRA CONNECTORS

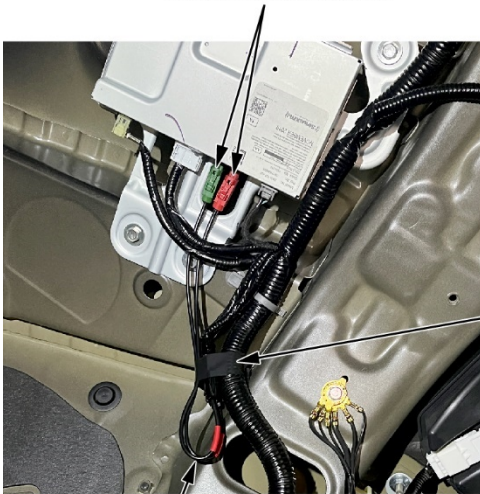

Attach the FAKRA service cables and splice boxes to the appropriate component harness with tape to prevent any rattles.

Keep smooth curves with a radius bend greater than 25 mm.

PASSPORT – FINISHING REPAIR PROCEDURE

1. Install all of the removed parts in the reverse order of removal.

NOTE:

- When reinstalling components, make sure the harness is routed correctly. A **misrouted harness** can put pressure on the wires and connectors, causing connection issues.
 - **Do not pull** on the units or MOST cables while the FAKRA connectors are connected to help prevent communication issues.
2. Start the vehicle and verify gauge control module, infotainment control unit operates normally, push the power button OFF, open and close the driver's door and restart the vehicle reverify gauge control module, infotainment control unit operates normally. If all systems operate normally, repair is complete.
 3. If components do not operate as intended, reinspect FAKRA Splice repair service cables, splice box connections and routing. Make sure the splice box arrow is pointing to the red flag label or red sleeve on the FAKRA Splice box service cable.

NOTE: If all FAKRA splice repair service cables, splice box connections, and routing are correct, follow normal troubleshooting procedures per System Information Search on iN.

END