

February 17, 2023

Version 1

Safety Recall: 2023 CR-V Front Passenger Seat Frame

AFFECTED VEHICLES

Year	Model	Trim	VIN Range
2023	CR-V	2WD EX-L, AWD EX-L	Check the iN VIN status for eligibility.

BACKGROUND

During manufacturing, a small number of front passenger seat-back frames may have been improperly welded on one side. An improperly welded seat frame may not hold the seat in position during a collision preventing the occupant from being properly restrained.

CUSTOMER NOTIFICATION

Owners of affected vehicles will be sent a notification of this safety recall.

Do an iN VIN status inquiry to verify eligibility.

Some vehicles affected by this campaign may be in your new or used vehicle inventory.

Failure to repair a vehicle subject to a recall or campaign may subject your dealership to claims or lawsuits from the customer or anyone else harmed as a result of such failure. To see if a vehicle in inventory is affected by this safety recall, do a VIN status inquiry before selling it.

CORRECTIVE ACTION

Remove the seat-back frame and replace it with a new one.

PARTS INFORMATION

NOTE: There are very limited number of units affected. You must check the VIN responsibility report before ordering.

Part Name	Part Number	Quantity
Right Front Seat-Back Frame	81126-3A0-A71	1
Nut-Washer (6mm)	90321-SP0-A80	2

CUSTOMER INFORMATION:The information in this bulletin is intended for use only by skilled technicians who have the proper tools, equipment, and training to correctly and safely maintain your vehicle. These procedures should not be attempted by "do-it-yourselfers," and you should not assume this bulletin applies to your vehicle, or that your vehicle has the condition described. To determine whether this information applies, contact an authorized Honda automobile dealer.

WARRANTY CLAIM INFORMATION

Operation Number	Description	Flat Rate Time	Defect Code	Symptom Code	Template ID	Failed Part Number
8621K1	Remove the passenger's front seat back frame and replace it with a new one. (Includes sensor initiation and steering re-learn.)	1.1 hr	6PK00	ND600	A23018A	81126-3A0-A71

REPAIR PROCEDURE

1. Remove the head restraint from the front passenger's seat and set it aside.

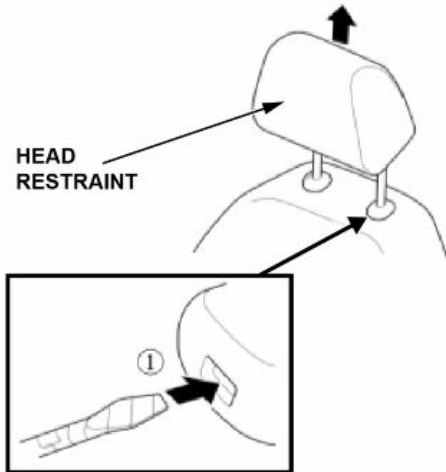

2. Adjust the front passenger's seat to the most forward position until the rail bolts are fully visible, then remove the bolts.

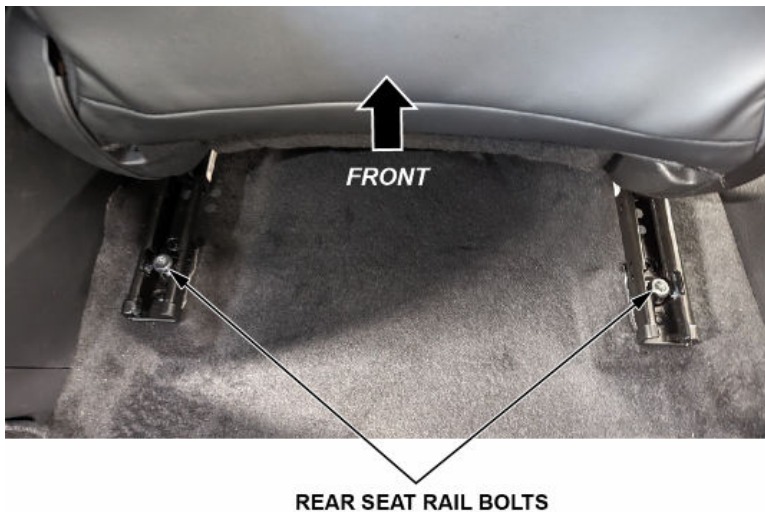

- Adjust the front passenger's seat to the most rear position and carefully remove the seat foot cover.

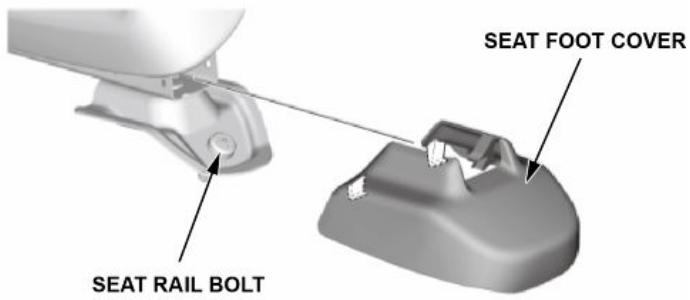

- Disconnect the 12V battery's negative terminal.
NOTE: Wait at least **3 minutes** before proceeding to the next steps.
- Remove the front seat rail bolts.
- Carefully and slowly tilt back the seat assembly to expose the harness and connectors.

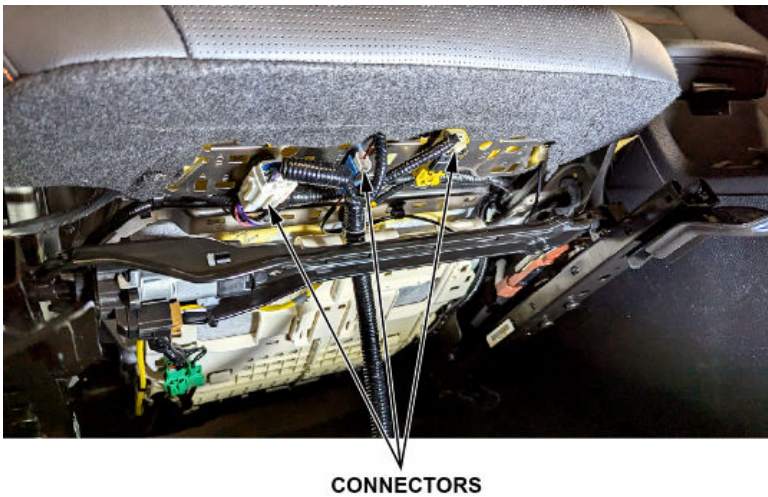

- Disconnect each connector clip as shown below.

Slide Locking Connector

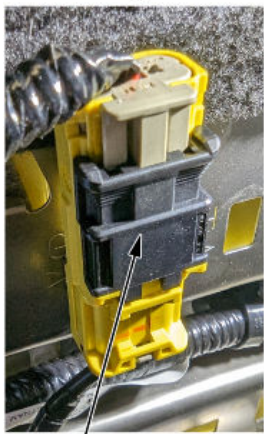

SLIDE LOCK

Tab Release Connector



TAB RELEASE

Tab Release Connector

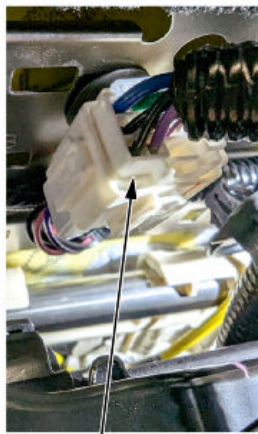

TAB RELEASE

- Carefully remove the front passenger's seat from the vehicle and place it on a clean workspace.
NOTE: Use a protective mat over the door panel to avoid any damage during the seat removal.

9. Remove the screw and carefully remove the cover without damaging the locking tabs.

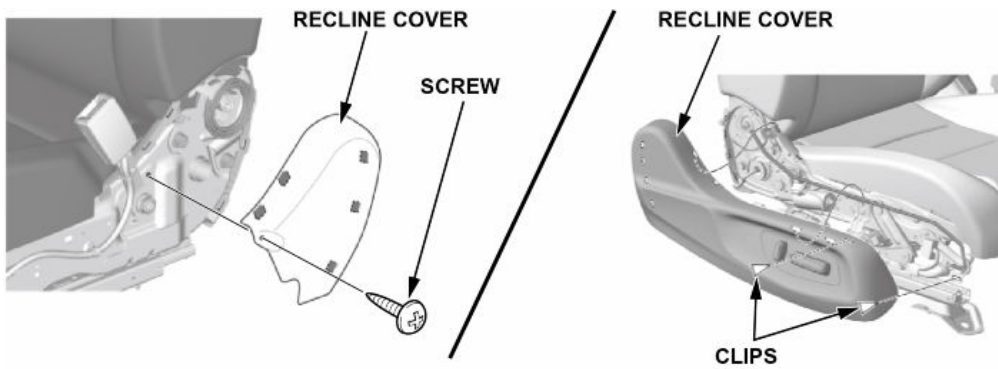

10. Gently pull the front and rear cover to disconnect clips and locking tabs. Then, disconnect the wire harness clip.

11. Remove the seat-back cover.

11.1. Unhook the seat bottom cover to expose the zippers. Then, unzip both zippers.

11.2. Unhook the upper clips from underneath the seat cover as shown.

11.3. Remove the head restraint lock guides by squeezing both locking tabs while pressing up.

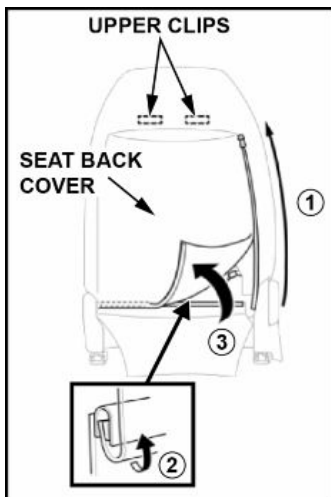

(1) Unhook the seat bottom cover to expose the (2) zippers. Unzip both zippers.

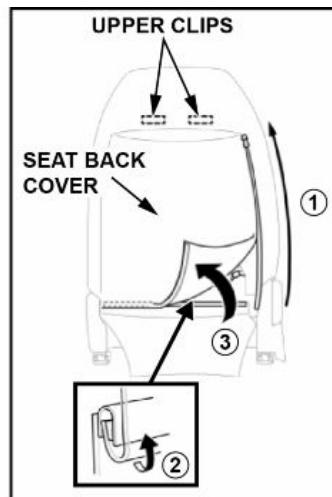

(2) Unhook (2) upper clips from underneath the seat cover.

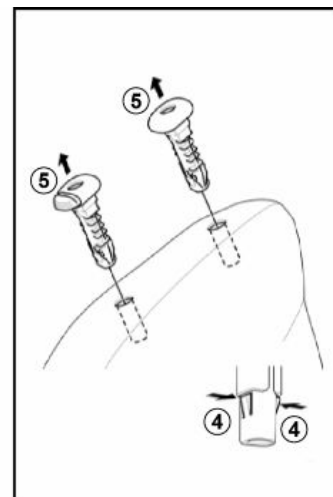

(3) Remove (2) head restraint lock guides by squeezing both locking tabs while pressing up.

12. Disconnect the seat heater harness clip from the seat-back and seat bottom.



SEAT BACK CLIP



SEAT BOTTOM CLIP

NOTE: When disconnecting the seat harness, note the harness routing between the seat-back and bottom; it is important during the installation process.

13. Remove the following SRS harness clips.

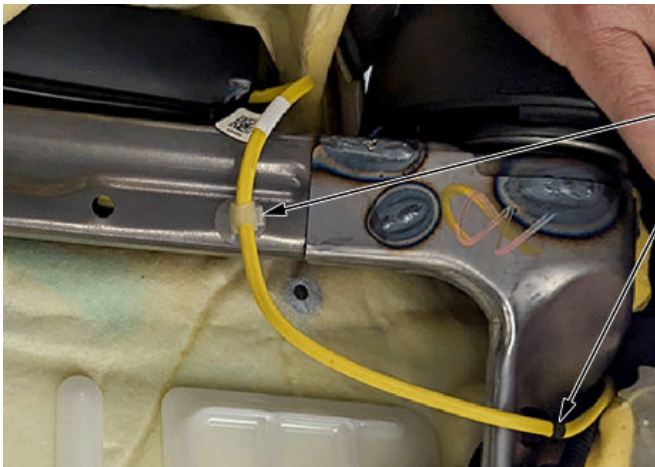

SRS HARNESS CLIPS

NOTE: When disconnecting the seat harness, note the harness routing between the seat-back and bottom; it is important during the installation process.

14. Disconnect the side airbag from the seat-back frame.



CONNECTOR
Disconnect.

SIDE AIRBAG
Disconnect.

14.1. Remove the two nut washers that secures the side airbag to the seat frame and discard them.

NOTE: Use the new nut washers for the installation process.

14.2. Make sure the seat is on a bench in the upright position. Place a protective mat over the seat bottom cushion.

14.3. Remove the airbag from the seat frame and lay it on top of the protective mat over the seat bottom cushion.

NOTE: It is important to make sure that the airbag harness is secure to prevent damage from falling or bumping into another object.

15. Disconnect the seat heater connector clips as shown below.

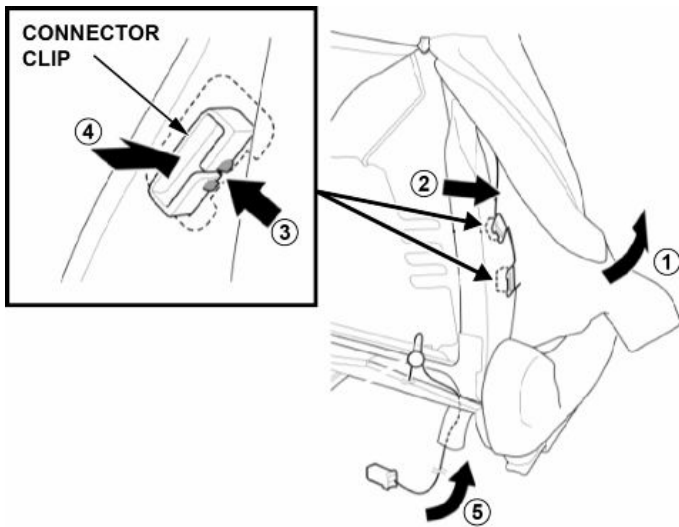

16. Remove the seat cushion and cover.



- 16.1. Starting at the sides of the seat-back base, gently pull away any seat cushion that are interfering with the seat frame.
- 16.2. Slowly slide the cushion and cover up (together) and over the seat frame until fully removed.
- 16.3. Set it aside on a clean work area.

17. Disconnect the reclining motor connector and harness clip.

MOTOR CONNECTOR



HARNES CLIP



18. Remove the lumbar support mat.

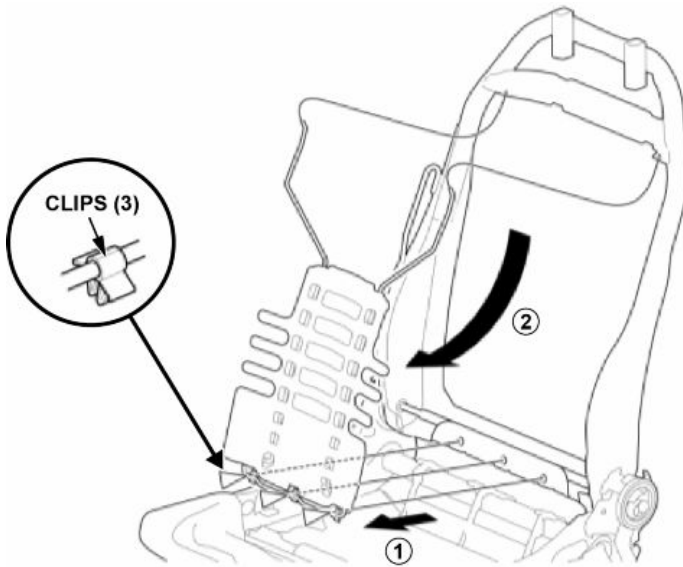

19. Remove the seat rear outer-rail screw.



SEAT OUTER RAIL

20. Remove the four seat bolts (two on each side) that connect the seat-back and bottom.

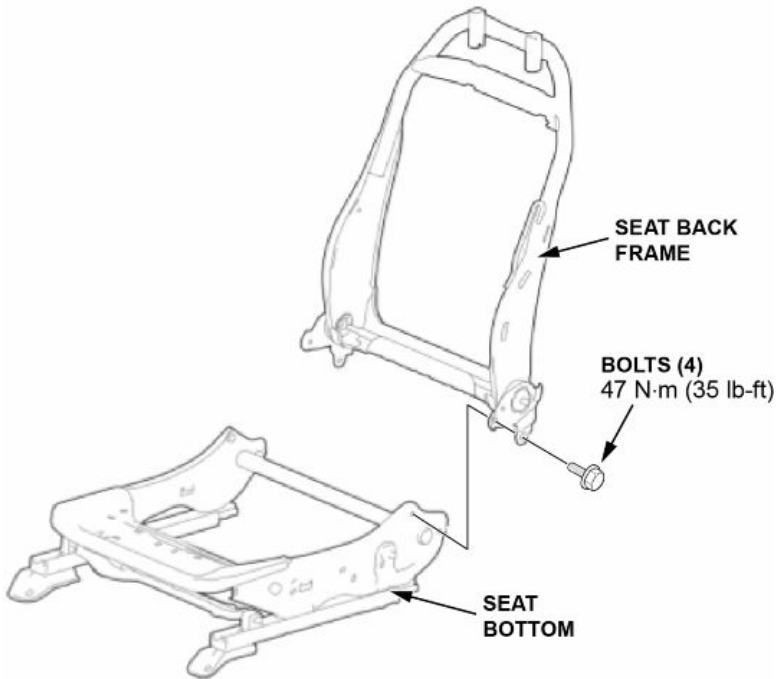

21. Carefully separate the seat-back frame from the seat bottom.

22. Install all parts in the reverse order of removal.

22.1. Tuck the bottom of the seat cover to cover the seat frame.



SEAT COVER
Tuck bottom of cover under to cover seat frame.

22.2. Before installing the side airbag and seat heater connectors, ensure the harnesses are routed properly.

22.3. During the side airbag install process, replace the two nut-washers with new ones, and torque them to **6.3 N.m (4.6 lb-ft)**.

22.4. During the lumbar mat reinstall process, apply multipurpose grease before installing the wire.



23. Torque the front and rear seat mounting bolts to **43 N.m (32 lb-ft)**.

24. After reconnection of the 12V battery's negative terminal, do the following.
 - 24.1. Initialize the front passenger's weight sensor.
 - 24.2. Confirm the seat operation by moving the passenger's seat and the seat-back through their full ranges of movement. Make sure the harness are not pinched or interfering with other parts.
 - 24.3. Do a SRS operation confirmation by turning the vehicle to the ON mode and checking that the SRS indicator comes on for about **6 seconds** and then goes off.

END