

Safety Recall

Code: 93U9



Subject High-Voltage Battery Modules

Document History

Date	Summary
05/09/2025	Added claiming for leak test before opening the HV battery.
03/19/2025	FINAL REMEDY LAUNCH: Affected vehicle criteria, parts information, claiming, owner letters & work instructions updated to reflect final recall remedy.
02/16/2024	Original publication (interim monitoring program)

Affected Vehicles

Country	Beginning Model Year	Ending Model Year	Vehicle	Vehicle Count
USA	2019	2022	E-TRON QUATTRO	8,264
USA	2020	2022	E-TRON SPORTBACK QUATTRO	1,491
CAN	2019	2022	E-TRON QUATTRO	1,457
CAN	2020	2022	E-TRON SPORTBACK QUATTRO	559

Check Campaigns/Actions screen in Elsa on the day of repair to verify that a VIN qualifies for repair under this action. Elsa is the only valid campaign inquiry & verification source.

- ✓ Campaign status must show "open."
- ✓ If Elsa shows other open action(s), inform your customer so that the work can also be completed at the same time the vehicle is in the workshop for this campaign.

Problem Description

A potentially critical self-discharge condition exists in certain high-voltage battery modules that, in some instances, may lead to thermal overload, possibly resulting in smoke or a fire. A high-voltage battery overheating increases the risk of a fire.

Corrective Action

Update vehicle software and, if necessary, inspect the high-voltage battery modules in affected vehicles.

High-voltage battery module inspection, when necessary, will take up to two (2) days to complete. If the inspection shows that a battery module needs replacement, dealers will order the necessary parts and perform the replacement. This work can take up to three (3) days to complete, depending on the number of modules requiring replacement.

Precautions

As a precautionary measure to help protect the high-voltage battery modules in affected vehicles until the recall remedy work has been completed, Audi recommends setting the maximum battery charge to 80%.

The vehicle owner's manual contains important information about charging the vehicle, and regarding the vehicle's warning lights and messages. We encourage owners and anyone who drives the vehicle to review the owner's manual to become familiar with charging procedures, and with the types of vehicle indicators, warnings and messaging they may see.

Code Visibility

On December 22, 2023 the campaign code was applied to affected vehicles.

Owner Notification

Recall remedy available owner notification letters will be mailed in April 2025. Owner letter examples are included in this bulletin for your reference.

Additional Information

Please alert everyone in your dealership about this action, including Sales, Service, Parts and Accounting personnel. Contact Warranty if you have any questions.

IMPORTANT REMINDER ON VEHICLES AFFECTED BY SAFETY & COMPLIANCE RECALLS

New Vehicles in Dealer Inventory: It is a violation of federal law for a dealer to deliver a new motor vehicle or any new or used item of motor vehicle equipment (including a tire) covered by this notification under a sale or lease until the defect or noncompliance is remedied. By law, dealers must correct, prior to delivery for sale or lease, any vehicle that fails to comply with an applicable Federal Motor Vehicle Safety Standard or that contains a defect relating to motor vehicle safety.

Pre-Owned Vehicles in Dealer Inventory: Dealers should not deliver any pre-owned vehicles in their inventory which are involved in a safety or compliance recall until the defect has been remedied.

Parts Information

NOTE

- When a vehicle is known to need a cell module, the VIN will be assigned criteria associated with the module part number. This allows parts to be ordered ahead of time, so parts are available when the customer arrives for their appointment.
- For every module known to need replacement, the VIN will be assigned criteria J1 through J*, and H1 through H*, which are associated with the module part number.
- The J1 through J*, and H1 through H* criteria also indicate how many of each module part number are known to need replacement.

**The following parts are needed when the vehicle requires a cell module replacement.
Order as needed depending on the quantity and position of the module being replaced.**

Quantity	Part Number	P.O.C. Part Description	Ordering Method
As needed	4KE-915-591-J	BATTERY	Reference POC comments individually by part number, or in the POC Campaign List
As needed	4KE-915-591-H	BATTERY	
1 per module	D -G00-020-M2	Paste	
4 per module	WHT-009-516	Screw	
8	12E-915-754	VALVE	
1	4KE-121-809-B	Sealant	
4	4KE-801-332	SOUND ABS	
4	4KE-801-557	BANJO BOLT	
2	4KE-805-696	SOUND ABS	
1	4KE-915-433	GASKET	
2	4KE-915-434	GASKET	
3	80A-886-373	GROMMET	
3	D -450-P00-M2	BUTYL TAPE	
1	G -052-567-A2	GREASE	
1	G -12E-100-1G CON	G12 EVO Coolant Concentrate (US Dealers)	
1	G -12E-100-2G CON	G12 EVO Coolant Concentrate (Canadian Dealers)	
18	N -101-961-07	SCREW	
2	N -106-421-04	BOLT	
50	N -106-847-01	BOLT	
2	N -906-132-01	SEAL RING	
18	N -910-661-01	BOLT	
2	N -911-407-01	BOLT	
2	N -911-900-02	BOLT	
2	N -912-461-01	SCREW	
2	N -912-721-01	SCREW	
95	WHT-008-659	BOLT	
13	WHT-008-738-A	BOLT	

Initial Allocation: NO	There will be no parts allocation. Please reference the Repair Projection Tool (below) to view your potential VIN population.
---	---

NOTE

Your dealer's Estimated Remaining Repairs by campaign can be found in Parts on Command. Click on "View Campaign List" and review the Estimated Remaining Repairs column.

NOTE

Campaign parts should always be ordered as per the parts information in this circular. The ordering system will supersede the part, if applicable.

Claim Entry Instructions

The labor times listed here may differ from the labor operations and labor times listed in ELSA.

After campaign has been completed, enter claim as soon as possible to help prevent work from being duplicated elsewhere. Attach the Elsa screen print showing action open on the day of repair to the repair order.

If a customer declines campaign work, refer to the “Customer Declines Campaign/Update Repair” section in the Campaign/Update Policy and Procedures Manual.

Service Number	93U9
Damage Code	0099
Parts Vendor Code	002
Claim Type	Sold vehicle: 7 10 Unsold vehicle: 7 90
Causal Indicator	Mark labor as causal if high voltage battery is OK or the vehicle only requires the software update Mark BATTERY* as causal if one or more cell modules require replacement
Vehicle Wash	Do not claim wash under this action
Vehicle Loaner	See special claiming instructions for rental/loaner claiming. NOTE: A 2nd claim must be entered for rental/loaner claiming

Overview of criteria:

SY – Final remedy software

04 – Final in-dealer analysis required (interim software update was not completed)

SD – No longer used

GE – No longer used (replaced by SY)

J1 through J* and H1 through H* – Assigned to vehicles known to need cell module replacement. Must be entered on claim if assigned.

LABOR CLAIMING INSTRUCTIONS

Vehicles may also have J* / H* criteria assigned. These will also all have to be entered on the claim when applicable.

If battery evaluation results in cell module replacement, vehicles without pre-identified modules will not have J* or H* criteria added for visibility in ELSA.

Criteria I.D.	SY - Enter when the final software update is completed.		
	Perform final software update		
	Labor Op	Time Units	Description
	0151 00 10	SEE ELSA	Battery charge
	0151 00 60	Time stated on diagnostic protocol	Software update

Criteria I.D.	04 - Enter when the in-dealer analysis is performed.		
	Perform test plan to check for cell modules that require replacement.		
	Labor Op	Time Units	Description
	9303 06 99	50	Check high voltage battery

Continued on next page

AND (if necessary)	If module(s) require replacement, claim <u>all applicable</u> J* / H* criteria along with 04 (if assigned)		
	ADD as needed if cell module(s) require replacement		
	Labor Op	Time Units	Description
	2706 89 50	See ELSA	Connected battery charger
	0150 00 60	Time stated on diagnostic protocol	GFF/Guided functions
	9301 19 50	See ELSA	Battery module remove+reinstall (level 1)
	9301 19 51	See ELSA	Battery module remove+reinstall (level 1 – each <u>additional</u> module)
	9301 19 52	See ELSA	Battery module remove+reinstall (level 2)
	9301 19 53	See ELSA	Battery module remove+reinstall (level 2 – each <u>additional</u> module)
	9301 89 50	See ELSA	Battery module charge (can be claimed multiple times)
	<i>NOTE: LO 9301 89 50 should only be claimed multiple times if adjacent cell modules controlled by the same battery module control module also required charging/discharging</i>		
	9302 03 50	See ELSA	Battery housing measure (potential equalization)
	9302 19 50	See ELSA	Battery housing remove+reinstall (cover – level 2) (Only if level 1 does not need to be opened)
	9302 19 51	See ELSA	Battery housing remove+reinstall (cover – level 2) (e-tron S ONLY) (Only if level 1 does not need to be opened)
	9302 19 60	See ELSA	Battery housing remove+reinstall (cover – level 1)
	9302 19 62	See ELSA	Battery housing remove+reinstall (cover – level 1) (e-tron S ONLY)
	9303 01 52	See ELSA	High voltage battery check (classification)
	9303 01 50	See ELSA	High voltage battery check (leak test – level 1 ONLY) (Only if level 1 needs to be opened)
	9303 01 54	See ELSA	High voltage battery check (leak test – level 1 and level 2)
	9303 01 58	See ELSA	High voltage battery check (initial set up – level 1 and level 2)
	9303 01 62	See ELSA	High voltage battery check (leak test – before opening HV battery)
	9303 19 00	See ELSA	High voltage battery remove+reinstall
	9303 19 02	See ELSA	High voltage battery remove+reinstall (e-tron S ONLY)

Continued on next page

	Labor Op	Time Units	Description
	1938 35 50	See ELSA	Coolant inspect+add
	9310 83 50	See ELSA	Disable HV system voltage deactivate and activate <i>(diagnostic activation HV system)</i>
	9327 19 50	See ELSA	Switch box high-voltage battery remove+reinstall <i>(Only if level 1 needs to be opened)</i>
	9325 19 50	See ELSA	ECM Battery Management System remove+reinstall
	7057 19 05	See ELSA	A-pillar trim remove+reinstall <i>(lower)</i>
	9301 01 50	See ELSA	Battery module check <i>(classification)</i>
	9301 00 50	See ELSA	Battery module – Package critical HV-ECM <i>(only if test plan indicates module was in critical state)</i>

Continued on next page

PARTS CLAIMING INSTRUCTIONS

Criteria I.D.	If pre-determined module(s) are replaced, also claim ALL applicable J* / H* criteria.		
	Claim the following parts as needed if one or more modules require replacement.		
	Quantity	Part Number	Description
	8.00	12E915754	VALVE
	1.00	4KE121809B	Sealing
	4.00	4KE801332	Damping
	4.00	4KE801557	BANJO BOLT
	2.00	4KE805696	SOUND ABS
	1.00	4KE915433	GASKET
	2.00	4KE915434	GASKET
	As required	4KE915591H	BATTERY* (module)
	As required	4KE915591J	BATTERY* (module)
	3.00	80A886373	GROMMET
	3.00	D 450P00M2	BUTYL TAPE
	1.00 per module	D G00020M2	Paste
	Up to 85.00 or Up to 4.25	G 12E100S1 or G 12E050S0	COOLANT (concentrate) or COOLANT (pre-mix)
	Up to 85.00 or Up to 170.00	G 12E100S1 or G 12E050S0	COOLANT (concentrate) or COOLANT (pre-mix)
	1.00	G 052567A2	GREASE
	18.00	N 10196107	Screw
	2.00	N 10642104	BOLT, HEX, HD. WITH SHOULDER
	50.00	N 10684701	OVAL HEXAGON SOCKET HEAD BOLT

Continued on next page

	Quantity	Part Number	Description
	2.00	N 90613201	ROUND SEAL
	18.00	N 91066101	BOLT, HEX. HD. (COMBI.)
	2.00	N 91140701	HEXAGON SOCKET OVAL HEAD BOLT (COMBI)
	2.00	N 91190002	BOLT
	2.00	N 91246101	SCREW
	2.00	N 91272101	SCREW
	95.00	WHT008659	BOLT
	13.00	WHT008738A	BOLT
	4.00 per module	WHT009516	Screw

ADDITIONAL CLAIMING INSTRUCTIONS

Vehicle Loaner (if required)	Enter vehicle loaner claim as a separate (2nd) claim Vehicles assigned ONLY SY are not eligible for loaner coverage		
	Claim Type	7 MO	(letter O, not number 0)
	Service Number	93U9	
	Damage Code	0010	
	Parts Vendor Code	002	
	Criteria	MO	(letter O, not number 0)
	<i>NOTE: Criteria MO must be entered on the vehicle loaner claim. If it is not entered, the campaign will close out completely.</i>		
	Outside Labor Operation	LOAN1600	Enter dollar amount on rental/loaner invoice: US Dealers - \$50 max per day Canadian Dealers - \$60 max per day
			(1 day maximum for waiting for evaluation results) -OR- (3 day maximum for battery repairs <u>and</u> waiting for evaluation results)

Customer Letter Example (USA)

This notice applies to your vehicle: <MODEL YEAR> <BRAND> <CARLINE>, <VIN>

NHTSA: 23V867

Subject: Safety Recall 93U9 – High-Voltage Battery Modules

Dear Audi Owner,

This notice is sent to you in accordance with the National Traffic and Motor Vehicle Safety Act. Audi has decided that a defect, which relates to motor vehicle safety, exists in certain 2019-2022 model year Audi vehicles. Our records show that you are the owner of a vehicle affected by this action.

What is the issue?

A potentially critical self-discharge condition exists in certain high-voltage battery modules that, in some instances, may lead to thermal overload, possibly resulting in smoke or a fire. A high-voltage battery overheating increases the risk of a fire.

What will we do?

To correct this defect, your authorized Audi dealer will update vehicle software and, if necessary, inspect the high-voltage battery modules in affected vehicles.

- The software update will take about an hour to complete and will be performed for you free of charge.
- High-voltage battery module inspection (if necessary), can take up to two (2) days to complete. If the inspection shows that a battery module needs replacement, dealers will order the necessary parts and perform the replacement. This work can take up to three (3) days to complete, depending on the number of modules requiring replacement. Both the inspection and replacement, when necessary, will be performed for you free of charge.

Please keep in mind that your dealer may need additional time for the preparation of the work, as well as to accommodate their daily workshop schedule.

What should you do?

Please contact your authorized Audi dealer without delay to schedule this recall work. For your convenience, you can also visit www.audiusa.com and click on the "Find a Dealer" link to locate a dealer near you and schedule this service.

Precautions you should take:

As a precautionary measure to help protect the high-voltage battery modules in affected vehicles until the recall remedy work has been completed, Audi recommends setting the maximum battery charge to 80%.

Additional Information

- If you are the lessor and registered owner of the vehicle identified in this action, the law requires you to forward this letter immediately via first-class mail to the lessee within ten (10) days of receipt.
- If your authorized Audi dealer fails or is unable to complete this work free of charge within a reasonable time, if you have changed your address or no longer own the vehicle identified in this letter, or if you should have any questions about this communication, please contact Audi Customer Experience at 1-800-253-2834 or via our "Contact Us" page at www.audiusa.com.
- If you still cannot obtain satisfaction, you may file a complaint with: The Administrator, National Highway Traffic Safety Administration, 1200 New Jersey Avenue, SE., Washington, DC 20590; or call the toll-free Vehicle Safety Hotline at 1-888-327-4236 (TTY:1-888-275-9171); or go to <http://www.safercar.gov>.
- To check your vehicle's eligibility for repair under this or any other recall/service campaign, please visit the Recall/Service Campaign Lookup tool at www.audiusa.com and enter your Vehicle Identification Number (VIN).
- If you have previously paid for repairs relating to the condition described in this letter, the enclosed form explains how to request reimbursement. We would be pleased to review your reimbursement request.

We apologize for any inconvenience this matter may cause; however, we are taking this action to help ensure your safety and continued satisfaction with your vehicle.

Sincerely,

Audi Customer Protection

Customer Letter Example (Canada)

<MONTH YEAR>

<CUSTOMER NAME>

<CUSTOMER ADDRESS>

<CUSTOMER CITY STATE ZIPCODE>

This notice applies to your vehicle: <MODEL YEAR> <BRAND> <CARLINE>, <VIN>

Transport Canada Recall: 2023-686

Subject: Safety Recall 93U9 – High-Voltage Battery Modules

Dear Audi Owner,

This notice is sent to you in accordance with the requirements of the *Motor Vehicle Safety Act*. This is to inform you that your vehicle may contain a defect that could affect the safety of a person. Our records show that you are the owner of a vehicle affected by this action.

What is the issue?

A potentially critical self-discharge condition exists in certain high-voltage battery modules that, in some instances, may lead to thermal overload, possibly resulting in smoke or a fire. A high-voltage battery overheating increases the risk of a fire.

What will we do?

To correct this defect, your authorized Audi dealer will update vehicle software and, if necessary, inspect the high-voltage battery modules in affected vehicles.

- The software update will take about an hour to complete and will be performed for you free of charge.
- High-voltage battery module inspection (if necessary), can take up to two (2) days to complete. If the inspection shows that a battery module needs replacement, dealers will order the necessary parts and perform the replacement. This work can take up to three (3) days to complete, depending on the number of modules requiring replacement. Both the inspection and replacement, when necessary, will be performed for you free of charge.

Please keep in mind that your dealer may need additional time for the preparation of the work, as well as to accommodate their daily workshop schedule.

What should you do?

Please contact your authorized Audi dealer without delay to schedule this recall work.

Precautions you should take:

As a precautionary measure to help protect the high-voltage battery modules in affected vehicles until the recall remedy work has been completed, Audi recommends setting the maximum battery charge to 80%.

Additional Information

- If you are the lessor and registered owner of the vehicle identified in this letter, you shall forward this letter (and any subsequent notice, if applicable) to the lessee within ten (10) days of receipt.
- If your authorized Audi dealer fails or is unable to complete this work free of charge within a reasonable time, if you have changed your address or no longer own the vehicle identified in this letter, or if you should have any questions about this communication, please contact Audi Customer Relations Monday through Friday from 8AM to 8PM EST at 1-800-822-2834 or via our "Contact Audi Canada" page at www.audi.ca.
- If you have previously paid for repairs relating to the condition described in this letter, the enclosed form explains how to request reimbursement. We would be pleased to review your reimbursement request.

We apologize for any inconvenience this matter may cause; however, we are taking this action to help ensure your safety and continued satisfaction with your vehicle.

Sincerely,

Audi Customer Protection

Safety Precautions When Working ON the High-voltage System (additional information is also available in the ELSA Repair Manual)

DANGER

Extremely dangerous due to high voltage.

- The high-voltage system is under heavy voltage. Severe bodily injury or death by electrocution or electric arcs is possible.
- When working on the high-voltage system the high-voltage system must be de-energized.
- When performing procedures that do not directly affect the high-voltage system, in some cases it is still necessary to de-energize the high-voltage system.
- Pay attention when the high-voltage system must be de-energized. Refer to the Repair Manual
- Have a High-Voltage Technician or a High-Voltage Expert de-energize the high-voltage system.

The electric and magnetic fields are extremely dangerous.

- There are electric and magnetic fields on the high-voltage system. Death or serious injury are possible due to malfunction of active implants (for example cardiac pacemakers, insulin pumps).
- Persons with active implants may not perform procedures on the high-voltage system.

WARNING

Risk of injury - motor may start unexpectedly

It is difficult to determine whether the drive system of an electric vehicle or hybrid vehicle is active. Moving parts can trap or draw in parts of the body.

CAUTION

Risk of damage to high-voltage wiring

- Incorrect handling may result in damage to the insulation of high-voltage wires or high-voltage connectors.
- Do not support yourself on high-voltage cables or connectors.
- Never prop tools against high-voltage wiring or high-voltage connectors.
- Never bend or kink high-voltage wiring.
- Observe the coding of the high-voltage connectors when joining them up.

Safety Precautions When Working NEAR the High-voltage System (additional information is also available in the ELSA Repair Manual)

DANGER

Extremely dangerous due to high voltage.

- The voltage levels in the high-voltage system constitute a safety hazard. Danger of severe or fatal injuries from electric shock if high-voltage components or high-voltage wiring are damaged.
- Carry out a visual check of high-voltage components and high-voltage wiring.
- Never use cutting/forming tools or other sharp-edged implements.
- Never perform work using welding, brazing, thermal bonding or hot air in the area of high-voltage components and high-voltage cables.

 **DANGER**

High voltage increases the risk of fatal injury

Electrocution can cause severe bodily or fatal injury.

- For the following procedures suitable personal protective equipment must be worn.
- For the following steps two correspondingly qualified technicians must be present for the supervision.
- If necessary, a second technician can help the high-voltage expert outside of the hazardous area within their qualification.
- The personal protective equipment (PPE) must be dry and undamaged.

Repair Overview

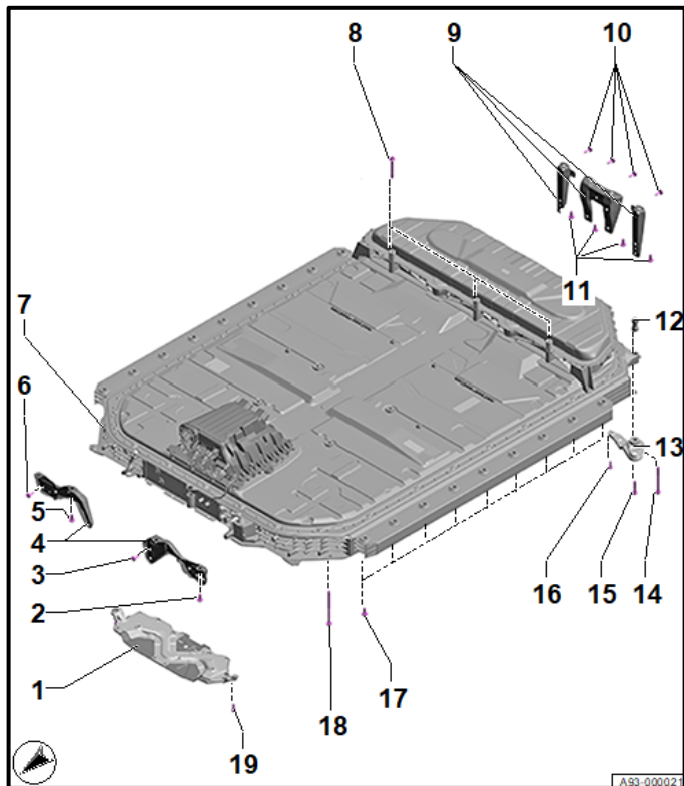

SY only – Perform final remedy software update

04 and SY – Perform final in-dealer analysis and perform final remedy software update

SY and J1 through J* and H1 through H* – Perform final remedy software update and replace pre-determined module(s) (evaluation still required to determine the position of module(s) to be replaced)

04 and SY and J1 through J* and/or H1 through H* – Perform final in-dealer analysis, perform final remedy software update and replace pre-determined module(s)

ALL – Remove stickers (if installed) from MMI and charging socket

NOTE

- These repair instructions may differ from the labor operations and labor times listed in ELSA.
- Damages resulting from improper repair or failure to follow these work instructions are the dealer's responsibility and are not eligible for reimbursement under this action.
- This procedure must be read in its entirety prior to performing the repair.
- Due to variations in vehicle equipment and options, the steps/illustrations in this work procedure may not identically match all affected vehicles.
- Diagnosis and repair of pre-existing conditions in the vehicle are not covered under this action.
- When working during extreme temperatures, it is recommended that the vehicle be allowed to acclimate inside the shop to avoid temperature-related component damage/breakage.

Required Tools (high-voltage battery evaluation and software update)



Battery Tester/Charger
capable of **minimum 90
Amp** continuous supply















Diagnostic Tester
-VAS6150X/6160X-
(or equivalent)

Required Tools (if HV battery cell module requires replacement)

	<p>Washer N -901-797-04 (qty. 2)</p>		<p>Guide Pin -T10341-</p>
	<p>Wedge Set -T10383- (or equivalent)</p>		<p>Holding Strap -T40155A- (qty. 2) (or equivalent)</p>
	<p>Oil Sump Assembly Pin -T40199-</p>		<p>Seal Plug -T40417- (qty. 2)</p>
	<p>Sealing Plug -T40418A- (qty. 3)</p>		<p>Cover -T40420-</p>
	<p>Shock-Proof Protection (30 Pcs) -T40421-</p>		<p>Sealing Device -T40422-</p>
	<p>Module Picker -T40424-</p>		<p>Adapter for diagnosis box HV battery -VAS5581/8-</p>



	<p>Swivel Bolt M10 -VAS691015- (qty. 2)</p>		<p>Lifting Eye -VAS691013- (qty. 2)</p>
	<p>Connection Cable -VAS6910/17-1-</p>		<p>Connection Cable -VAS6910/17-2-</p>
	<p>Hose Clip Pliers -VAS6340- (or equivalent)</p>		<p>Leak Tester - Rubber Bungs -VAS6911/10- (qty. 8)</p>
	<p>Leak Tester - Test Connector Set -VAS6911/3B-</p>		<p>Leak Tester - Seal Set -VAS6911/4- (qty. 2)</p>
	<p>Warning Sign - High Voltage -VAS6649-</p>		<p>Warning Sign - "Do Not Switch On" -VAS6650A-</p>
	<p>Warning Sign - Battery -VAS6786-</p>		<p>Warning Sign - "Do Not Insert" -VAS6871-</p>

 <p>Scraper Set -VAS6845- -or- -VAS895015-</p>	 <p>High-voltage tool set -VAS6762A- (or -VAS6762-)</p>
 <p>Plastic Wedge Set -VAS852015-</p>	 <p>Pneumatic Applicator - Cartridge Gun -VAS891005-</p>
 <p>Scissor Lift Table -VAS6131B- (or equivalent)</p>	 <p>Engine Bung Set -VAS6122- (or equivalent)</p>
 <p>Digital Pressure Sensor -VAG1397B-</p>	 <p>Shop Crane -VAS6100- (or equivalent)</p>
 <p>Cooling System Tester - Directional Valve -VAS691005/1- (component of -VAS691005-)</p>	 <p>High Voltage Tool Set - Torque Wrench -VAS6883/1A-</p>
 <p>High Voltage Tool Set - Voltage Tester -VAS6762/45- (component of - VAS6762A-)</p>	 <p>Cooling System Tester - Directional Valve -VAS691005/5- (component of -VAS691005-)</p>

	<p>Module Balancer -VAS6910- Or -VAS6910A-</p>		<p>Cooling System Service Machine – TEXA -VAS531011KIT-</p>
	<p>Cooling System Tester -VAG1274B-</p>		<p>Hose Clamps - Up To 25mm -3094- (or equivalent)</p>
	<p>Padlock -T40262/1- (from Service Disconnect Lock -T40262-)</p>		<p>Vehicle Diagnosis System - Connection Lead -VAS5051/66-</p>
	<p>Pressure Sensor -VAS611013-</p>		<p>Insulated Torx Wrench Set - 3/8 -VAS691003A-</p>
	<p>Test Adapter - Hybrid Module -VAS6558A-</p>		<p>*High Voltage Diagnostics Box -VAS5581A-</p>
	<p>Battery Tester/Charger capable of minimum 90 Amp continuous supply</p>		<p>Shackle (Equivalent to VAS691009A) -VAS691009US- Qty. = 5</p>

	<p>Diagnostic Tester -VAS6150X/6160X- (or equivalent)</p>		<p>Set of Kelvin Clamps and Test Probes -VAS6558A/27-</p>
	<p>Removal Tool -T40445- (or equivalent)</p>		<p>Spatula kit -VAS281011- (or equivalent)</p>
	<p>Insulating Mat -VAS6762/44- Qty. = 2</p>		

Required Shop Materials (if necessary)

	<p>Cleaner D -009-401-04 (shop supply) -OR- 91% Isopropyl Alcohol (locally sourced)</p>		<p>Lint Free Towels (locally sourced)</p>
<p><i>NOTE: Use only 91% Isopropyl alcohol as a cleaner (9% water). Do not use Isopropyl with any additional surfactants (cleaners) or additives (scents).</i></p>			

Repair Instruction

Section A - Check for Previous Repair

Applicable criteria ID(s)	Campaign/Action Status
01 ← 2	Open ← 1

EXAMPLE

Campaign/Action	Start	Designation
← 3 →	2015-11-10	W-SERV_ACT -
	2018-12-13	RECALL -
	2017-05-16	A-RECALL -

EXAMPLE

- Enter the VIN in Elsa and proceed to the “Campaign/Action” screen.

TIP

On the date of repair, print this screen and keep a copy with the repair order.

- Confirm the Campaign/Action is open <arrow 1>. If the status is closed, no further work is required.
- Note the Applicable Criteria ID <arrow 2> for use in determining the correct work to be done and corresponding parts associated.

CRITICAL REPAIR STEP

 **STOP!** 

All campaigns/actions with a repair available must be performed in order of the Start date <arrow 3>. The oldest should be performed first (unless otherwise noted in the repair instructions).

- **All Safety Recalls must be completed prior to completing this campaign.**

Vehicles assigned ONLY criteria SY:

- **Proceed to Section C**

All others:

- **Proceed to Section B**

Section B – Vehicles Assigned Criteria SY, 04 and/or J*/H* ONLY - Evaluating Need for Cell Module Replacement

! IMPORTANT

Before performing the final remedy software update, it is essential that the battery evaluation is carried out first.

! NOTE

Analysis of the high-voltage battery will be performed and is required to determine the following:

- Which position of the pre-determined cell module is to be replaced.
- If a cell module requires replacement.

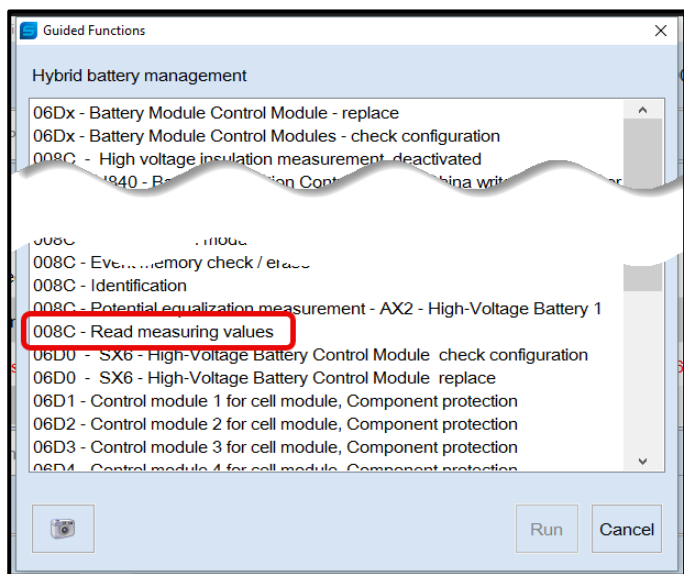

- Connect battery maintainer.
- Perform a full diagnostic scan of the vehicle.
- Select and perform the Guided Function test plan “008C – Read measuring values” for diagnostic address 008C.

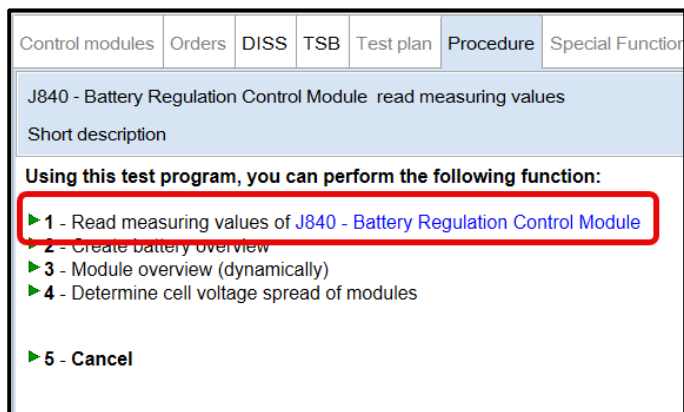

- Select the option “Read measuring values of J840 – Battery Regulation Control Module.”

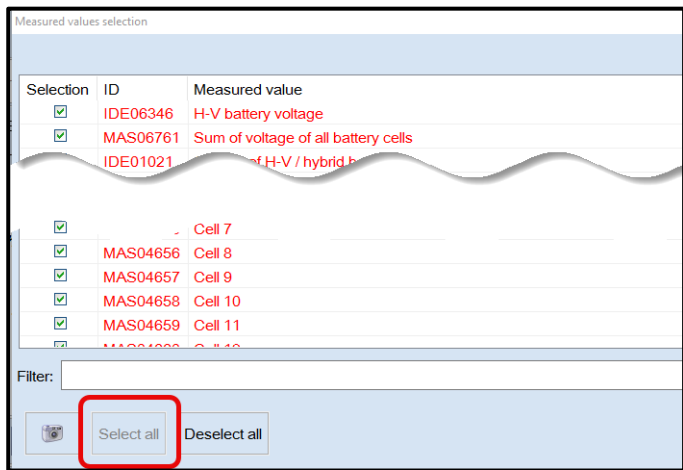

- Select all MVB's, then select OK.

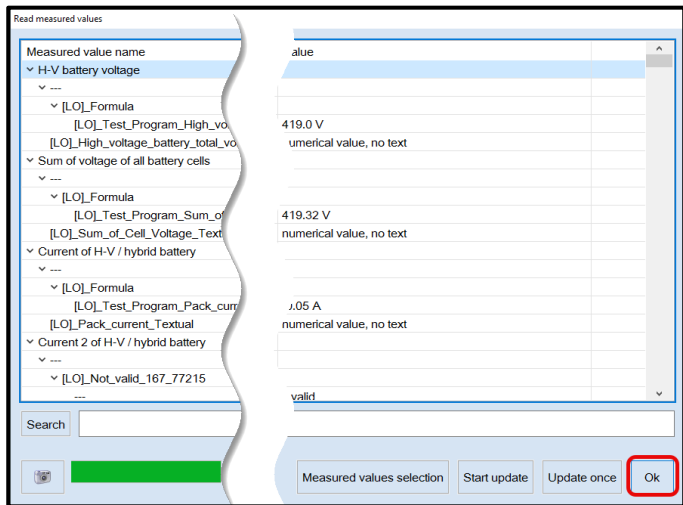

- When all MVB's are displayed, select OK.
- Follow the on screen prompts until the test plan is completed.
- Exit GFF.
- Ensure the diagnostic log is sent to GFF Paperless.

22 items found, displaying all.											
Sr.No	VIN	Diagnosis ID	Diagnosis Date	Transfer Date	Importer/Dealer	DTE (TU)	DTC	Tester ID	Repair Order	Log Status	Log Type
1		182560188	2023-07-19 00:00:00	2023-07-19 11:37:50		30	B153813	7afd411f4a98ef92cebed61b5aa51ece	---	Final	Guided Fault Finding
2		179616477	2023-02-02 00:00:00	2023-02-02 06:06:39		17	B153813	35ae23eb73cc47a4270f45fca1366550	---	Temporary	Guided Fault Finding

- Record the Diagnosis ID of the log from GFF Paperless.

Technical Assistance

Create Ticket

Ticket Information

Concern Type: 93V2/93U9 HV Battery Evaluation – Web Ticket Only Technician Email: _____

Technician Name: _____ Dealer Code: 000000

Vehicle Information

VIN: _____ Make: A

Model: 8K256H Model Year: 2011

Mileage: _____ Engine Code: CAEB

Contact Options:
 I will call flow
 I will wait for web response (up to 2 business hours) Transmission Code: MVC

Technician Questionnaire

Attachments

GFF Diagnosis ID: _____

Enter required worksheet information: Select a worksheet to download Download

Attachment Type: Select an attachment type File: Choose File No file chosen Attach Another Help

- Create a TAC Web Ticket as follows:
 - Select the correct concern group:
 - US DEALERS** - “93V2/93U9 HV Battery Evaluation – Web Ticket Only” as the concern group
 - CANADIAN DEALERS** - “93V2/93U9 HV Battery Evaluation”
 - Enter your preferred e-mail address.
 - Select “I will wait for a web response.”
 - Enter the GFF Diagnosis ID from the log uploaded to GFF Paperless.

IMPORTANT

The TAC case for analyzing the battery cannot be used for any other direction. If additional TAC assistance is needed (technical direction, cell balancer loaner program, etc.), a separate TAC case will need to be created.

- The response back from Germany may take up to 24 hours.
- During this time, the vehicle cannot be released to the customer.
- If the direction from Germany states no cell modules require replacement:
 - Proceed to Section C for Performing Final Software Update.
- If the direction from Germany states a cell module requires replacement:
 - The vehicle cannot be released to the customer until the module has been replaced and all final steps before returning vehicle to customer are completed (see Section E for final steps).
 - Proceed to Section C for Performing Final Software Update.
 - Once the final software update is completed, Proceed to Section D once all parts and tools are available to complete the repair.

Section C – Final Software Update Instructions

NOTE

Prior to launching the VAS Diagnostic Tester and starting an update, ensure the following conditions are met;

- ✓ **The ODIS software is completely up to date.**
 - Refer to the “Current ODIS Service Version” circular found in Elsa2Go Service References.
- ✓ **The battery charger is connected to the vehicle battery and remains connected for the duration of the software update.**
 - Battery voltage must remain above 12.5 volts for the duration of the software update. Failure to do so may cause the update to fail, which could result in damage to the control module. Control modules damaged by insufficient voltage will not be covered.
- ✓ **The screen saver and power saving settings are off.**
 - Failure to do so may result in the tester entering power save mode during the software update, which could result in damage to the control module.
- ✓ **The VAS Diagnostic Tester is plugged in using the supplied power adapters.**
 - Under no circumstances should the tester be used on battery power alone during the software update. Failure to do so may result in the tester powering off during the update, which could result in damage to the control module.
- ✓ **Flash process through “Audi Flashing” not Guided Fault Finding (GFF).**
 - DO NOT USE Guided Fault Finding (GFF) to perform this flash. Using GFF will cause the flash to take longer. Requests for additional time will not be considered.
- ✓ **The VAS Diagnostics Interface MUST ONLY be connected to the tester with a USB cable.**
 - Performing a software update using a Bluetooth or WiFi connection increases the risk of losing connection during the update, which could result in damage to the control module. It also greatly increases the time required to perform the update. Requests for additional time or parts will be denied if the GFF log shows the update was performed using Bluetooth or WiFi.

NOTE

- All campaign software updates must be completed during a single, standalone ODIS Diagnostic Session. You must fully complete this campaign and send all logs before beginning any other campaigns or operations.
- If there are any ODIS “Hot-Fix” patches installed, they must be removed from the scan tool before beginning this operation. ODIS “Hot-Fix” patches may affect the update process.

WARNING

Radiator Fan(s) may cycle ON high speed during the Update Process! There is a serious risk that personal injury may result if contact is made with spinning fan blades. Keep hands and all objects away from Radiator Fan(s) during Update Process!

IMPORTANT

To Update-Programming using SVM, review and follow instructions in Technical Bulletin 2011732: *Software Version Management (SVM) Operating Instructions for the US*, or 2037026: *Working with the Software Version Management (SVM) for Canada*.

The SVM Process must be completed in its entirety so the database receives the update confirmation response. A warranty claim may not be reimbursed if there is no confirmation response to support the claim.

- Switch off all consumers, air conditioning, heater blower motor, lights, heated seats, etc.
- Ensure the latest version of ODIS is downloaded.
- Ensure diagnostic head is connected to ODIS tester via USB cable.
- Move selector lever to P.

IMPORTANT

Vehicles assigned criteria 04 or vehicles assigned J*/H* criteria: Before performing the final remedy software update, it is essential that the battery evaluation is carried out first.

- Use operating mode, FLASH.
- Select "SVM – Code Input".
- Enter SVM code **93U9D103** and follow the on-screen prompts.
- Vehicle access = **DoIP**.
- When exiting the FLASH program, ensure the diagnostic log is sent to GFF Paperless.

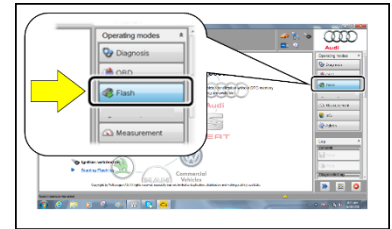

If a cell module(s) requires replacement – Proceed to Section D

If no cell module(s) required replacement – Proceed to Section E

Section D – Replacing Cell Module(s)

CRITICAL REPAIR STEP

 **STOP!** 

Before balancing the new cell module, be sure that the vehicle is ready for the repair to be performed.

If possible, the high voltage battery should be de-energized right after recording the voltage reading to avoid possible voltage variations.

Charging the vehicle, driving the vehicle, leaving the ignition on, or running the HVAC can change the high voltage battery voltage.

After reading out the maximum cell module voltage from the MVBs, avoid moving the vehicle if possible. The vehicle must not be charged or have any electrical consumers used. If this step is not followed, there is a risk that the new cell module will not be balanced correctly resulting in possible faults and having to remove and re-balance the cell module again.

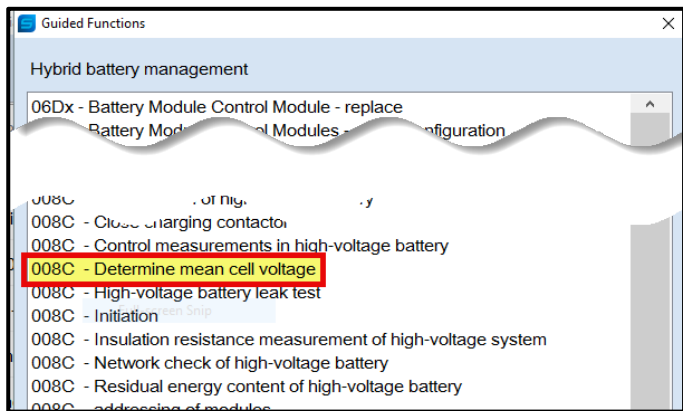

Perform cell balancing on new cell module(s):

- Perform the Guided Function test plan, “008C – Determine mean cell voltage” and record the mean voltage value.



- When charging or discharging a new cell module, follow the instructions in the ELSA repair manual in conjunction with the operating instructions for the cell balancer being used.

TIP

Operating instructions for the VAS6910, VAS6910A, and DSS Manager program can be found on the Audi Special Tools and Equipment website.

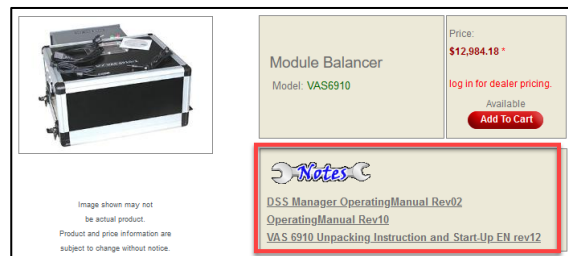

Image shown may not be actual product. Product and price information are subject to change without notice.

Module Balancer
Model: VAS6910
Price: \$12,984.18*
log in for dealer pricing.
Available
Add To Cart

Notes
DSS Manager Operating Manual Rev02
Operating Manual Rev10
VAS 6910 Unpacking Instruction and Start-Up EN rev12

Tests in current test plan	
Status	Tests (sorted according to chances of success)
>	J533 - Sequence error during operating mode setting - high voltage
>	J1050 - External charging infrastructure
	0001 - Check warranty info
	008C - Classification of high-voltage battery
	008C - Classification of a battery module
	008C - Initiation
	Establish high-voltage de-energization
	High-voltage re-energization

Populate Guided Function test plans:

- Perform a diagnostic scan of the vehicle.
- Select “Self Test” and populate the following test plans:
 - 008C - Classification of high-voltage battery
 - 008C - Classification of a battery module
 - 008C - Initiation
 - Establish high-voltage de-energization
 - High-voltage re-energization

Tests in current test plan	
Status	Tests (sorted according to chances of success)
>	J533 - Sequence error during operating mode setting - high voltage
>	J1050 - External charging infrastructure
	0001 - Check warranty info
	008C - Classification of high-voltage battery
	008C - Classification of a battery module
	008C - Initiation
	Establish high-voltage de-energization
	High-voltage re-energization

De-energize the high-voltage system:

⚠ DANGER

There is a risk of fatal injury due to high voltage. Electrocutation by direct contact or electric arc can cause severe bodily injury or fatal injury.

Have a high-voltage technician or a high-voltage expert de-energize the high-voltage system.

- Reference the ELSA Repair Manual:
 - *Repair manual > Motor > Electric Drive Motor 0EF > 93 Electric drive > High-Voltage System, De-Energizing.*
- Perform these steps in conjunction with the test plan “Establish high-voltage de-energization”.

Tests in current test plan	
Status	Tests (sorted according to chances of success)
>	J533 - Sequence error during operating mode setting - high voltage
>	J1050 - External charging infrastructure
	0001 - Check warranty info
	008C - Classification of high-voltage battery
	008C - Classification of a battery module
	008C - Initiation
	Establish high-voltage de-energization
	High-voltage re-energization

High-voltage battery classification:

- Reference the ELSA Repair Manual:
 - *Repair manual > Motor > Electric Drive Motor 0EF > 93 Electric drive > High-Voltage Battery Unit > High-Voltage Battery 1 AX2, Visual Inspection and Classification.*
- Perform these steps in conjunction with the test plan “008C – Classification of high-voltage battery”.

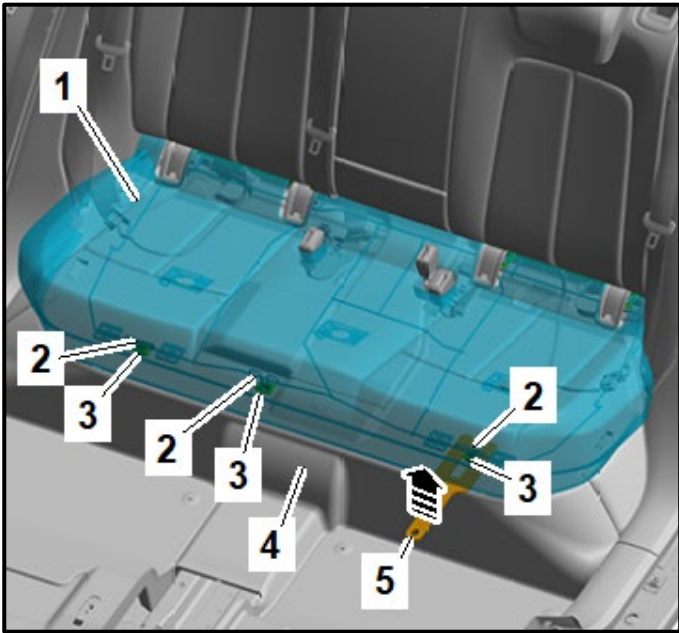

Remove the rear bench seat:

- Remove the rear bench seat <1> per the ELSA Repair Manual:
 - *Repair manual > Body > Body Interior > 72 Seat Frames > Rear Seats > Bench Seat/Single Seat, Removing and Installing.*



- Remove the bolts <arrows>.

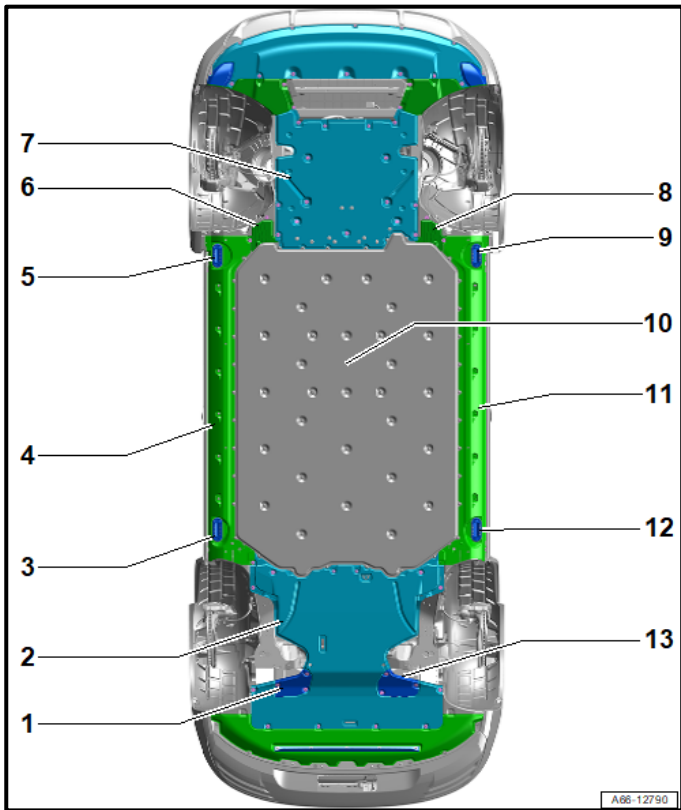

Remove front and rear underbody trim panels:

- Remove the following underbody trim panels:
 - Front trim panels <6>, <7>, and <8>.
 - Rear trim panels <1>, <2>, and <13>.

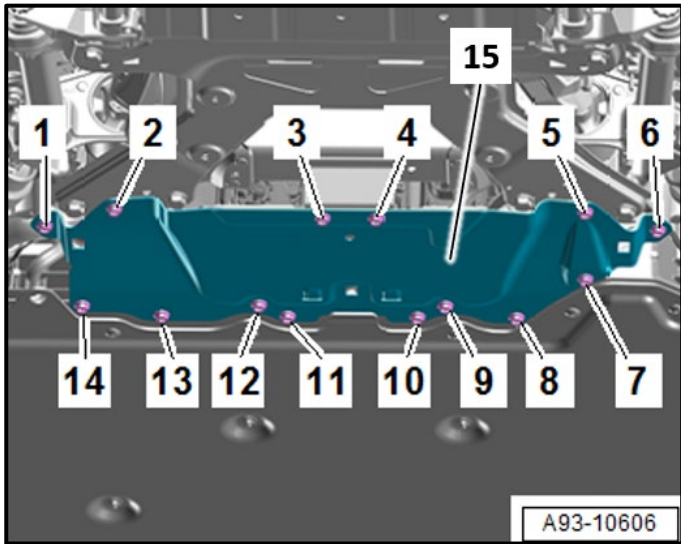

Remove the impact guard:

- Remove the impact guard <15> per the ELSA Repair Manual:
 - *Repair manual > Chassis > Suspension, Wheels, Steering > 40 Front Suspension > Subframe > Impact Guard, Removing and Installing.*

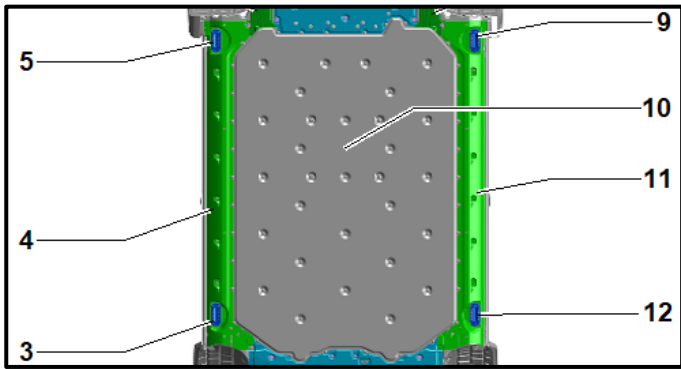

Remove left and right underbody trim panels:

- Lower the vehicle so that the hoist arms are no longer contacting the vehicle.
- Remove the left and right side trim panels <4> and <11>.
- Lift the vehicle again.

NOTE

Removal of the high-voltage battery is not possible on all hoists. Prior to removal, verify that there is sufficient clearance between the lift arms and the high-voltage battery frame so that it can be lowered without interference.

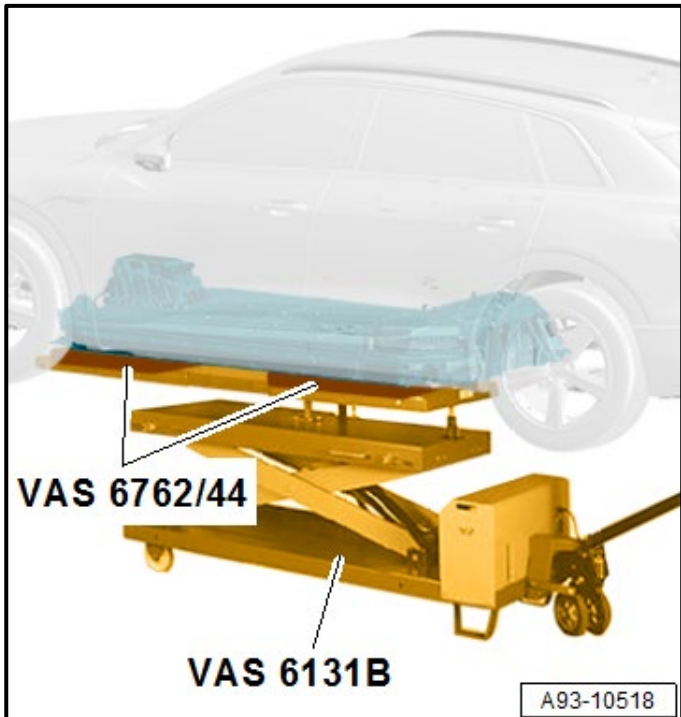

Remove the high-voltage battery:

- Remove the high-voltage battery per the ELSA Repair Manual:
 - *Repair manual > Motor > Electric Drive Motor 0EF > 93 Electric drive > High-Voltage Battery Unit > High-Voltage Battery 1 AX2, Removing and Installing.*
- Note the following when removing the high-voltage battery:
 - Mark the position of the scissor lift table on the floor to aid in repositioning the table during reinstallation.
 - Pay close attention to all wiring harnesses when lowering the battery.
 - Pay close attention to all coolant hoses when lowering the battery.

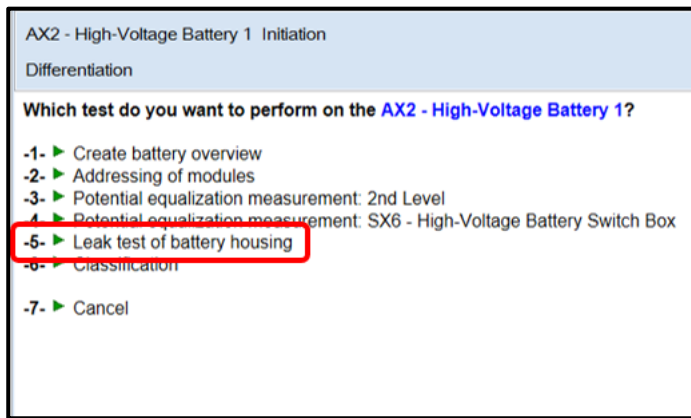

Perform high-voltage battery leak test:

- Perform the steps below in conjunction with test plan, “008C - Initiation > select option: Leak test of battery housing.”
- Perform a leak test of the high-voltage battery per the ELSA Repair Manual:
 - *Repair manual > Motor > Electric Drive Motor 0EF > 93 Electric drive > High-Voltage Battery Unit > High-Voltage Battery 1 AX2 Leak Test > Testing Tools, Cleaning and Checking.*
 - *Repair manual > Motor > Electric Drive Motor 0EF > 93 Electric drive > High-Voltage Battery Unit > High-Voltage Battery 1 AX2 Leak Test > Preparing for Calibration - High-Voltage Battery Leak Test, Part 1, 95 kWh / 115 kWh.*
 - *Repair manual > Motor > Electric Drive Motor 0EF > 93 Electric drive > High-Voltage Battery Unit > High-Voltage Battery 1 AX2 Leak Test > Preparing for Calibration - High-Voltage Battery Leak Test, 71 kWh, 95 kWh, 115 kWh Part 2.*
 - *Repair manual > Motor > Electric Drive Motor 0EF > 93 Electric drive > High-Voltage Battery Unit > High-Voltage Battery 1 AX2 Leak Test > Battery Housing Layer 2 Leak Test, 95 kWh / 115 kWh.*

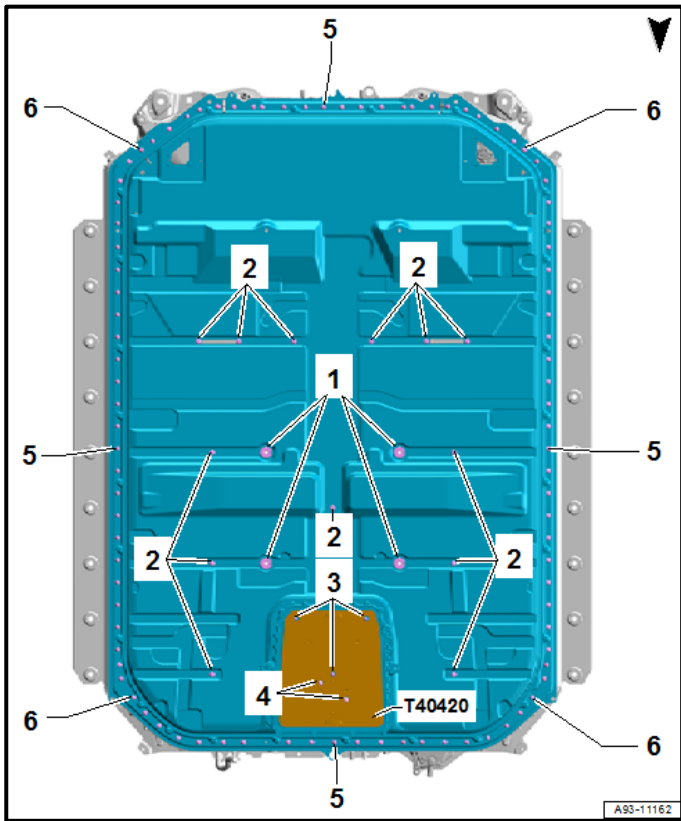

Remove the high voltage battery cover:

⚠ DANGER

There is a risk of fatal injury due to high voltage. Severe bodily injury or death by electrocution or electric arcs is possible.

The following procedures may only be performed by a qualified high-voltage expert HVE.

⚠ DANGER

There is a risk of fatal injury due to high voltage. Electrocution by direct contact or electric arc can cause severe bodily injury or fatal injury.

- For the following procedures suitable personal protective equipment must be worn.
- For the following steps two correspondingly qualified technicians must be present for the supervision.
- If necessary, a second technician can help the high-voltage expert outside of the hazardous area within their qualification.
- The personal protective equipment (PPE) must be dry and undamaged.

⚠ CRITICAL REPAIR STEP



RISK OF SEVERE CONSEQUENTIAL DAMAGE!

USE HAND TOOLS ONLY!

Do not use power tools to remove any of the bolts. Using power tools to remove the bolts can damage the threads in the lower housing. If the threads of the interior bolts <1>, <2>, <3>, and <4> are damaged, the lower housing will require replacement.

Claims for lower housing replacements due to improper bolt removal will be denied.

- Clean off any debris that has accumulated on the battery housing prior to opening.

⚠ CAUTION

Risk of damaging the high-voltage battery components due to incorrect handling.

Pay close attention to the ELSA repair manual cautions.

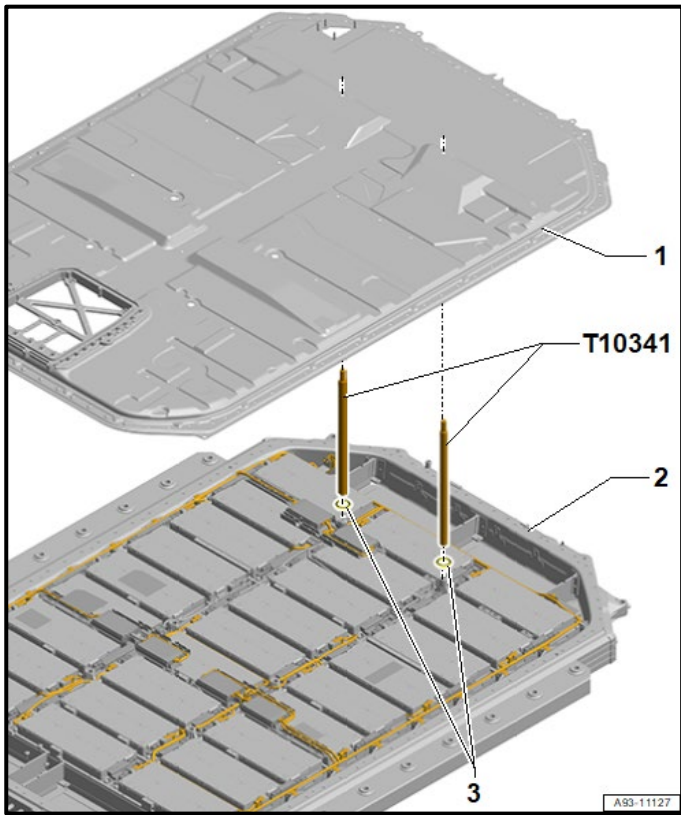

- Refer to the ELSA Repair Manual for high-voltage battery cover removal:
 - **Layer 1 module replacement:**
Repair manual > Motor > Electric Drive Motor 0EF > 93 Electric drive > High-Voltage Battery Components > Battery Housing Cover, Removing and Installing > Cover for Battery Housing Layer 1, Removing and Installing, 95 kWh / 115 kWh.
 - **Layer 2 module replacement:**
Repair manual > Motor > Electric Drive Motor 0EF > 93 Electric drive > High-Voltage Battery Components > Battery Housing Cover, Removing and Installing > Cover for Battery Housing Layer 2, Removing and Installing, 95 kWh / 115 kWh.

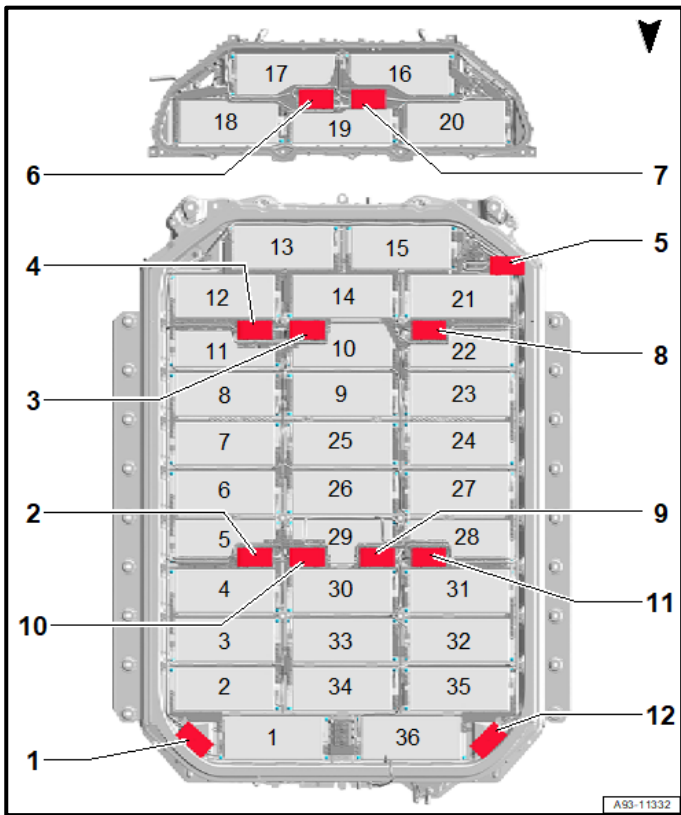

Identify the cell module that requires replacement:

- Locate and clearly mark the cell modules that are going to be replaced per the ELSA Repair Manual:
 - *Repair manual > Motor > Electric Drive Motor 0EF > 93 Electric drive > High-Voltage Battery Components > Battery Modules, Battery Connector and Control Modules, Marking.*

⚠ IMPORTANT

The level/layer (1 and/or 2) in which the module is replaced must be recorded on the repair order. This allows for proper claiming of the repair.

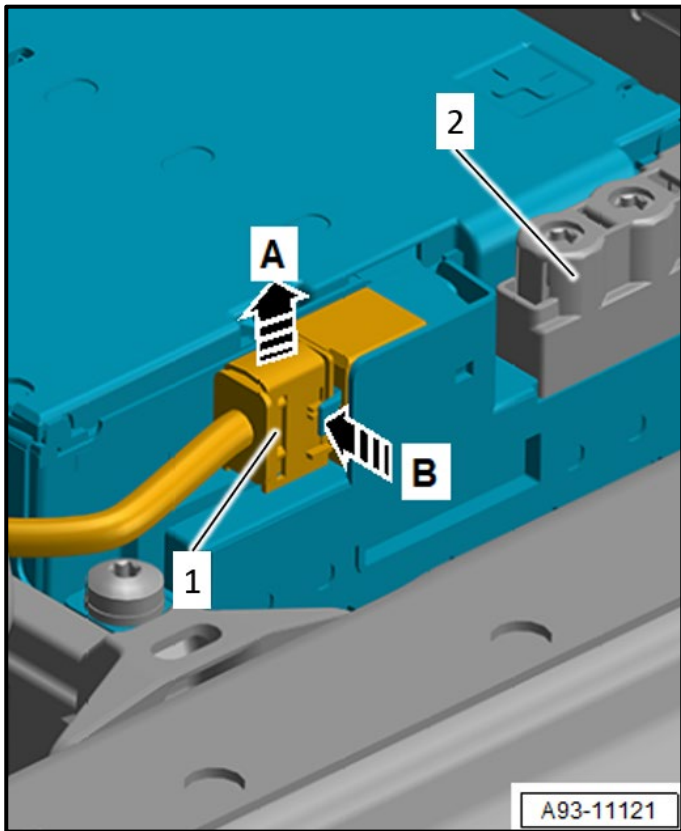

Remove the affected cell module(s):

⚠ CRITICAL REPAIR STEP



RISK OF CONSEQUENTIAL DAMAGE!

- Pay close attention to the repair manual steps.
- The 32-pin connector <1> must be removed before removing the high-voltage connection <2>. Failure to do so can result in damage to the battery module control module.
- Claims for replacement of the battery module control module due to improper cell module disconnection will be denied.

⚠ WARNING

There is a risk of injury by using the incorrect tools!

Never use a workshop crane to remove the battery module from the thermal compound.

⚠ CAUTION

Grease or dirt at the contact surfaces increases the contact resistance. It can overheat when the battery is put into operation. Risk of fire!

- Only touch the contact surfaces of the battery connectors and terminals of the battery modules when wearing gloves.
- Immediately clean dirty contact surfaces using isopropyl alcohol.

- Refer to the ELSA Repair Manual for cell module removal:

- *Repair manual > Motor > Electric Drive Motor 0EF > 93 Electric drive > High-Voltage Battery Components > Battery Module, Removing.*

- Ensure the shock protection is installed on ALL open high-voltage connections.



Clean the mounting area for the new cell module:

⚠ CAUTION

Contamination of the adhesive surface is possible due to the thermal compound containing silicone.

Avoid contact with adhesive surfaces.

- Ensure that the old thermal compound is removed from the battery housing per the instructions outlined in the cell module removal section.
- Vacuum any shavings/debris from the module threaded connections.
- Do not allow the cleaner to come into contact with any of the lower housing frame sealant.

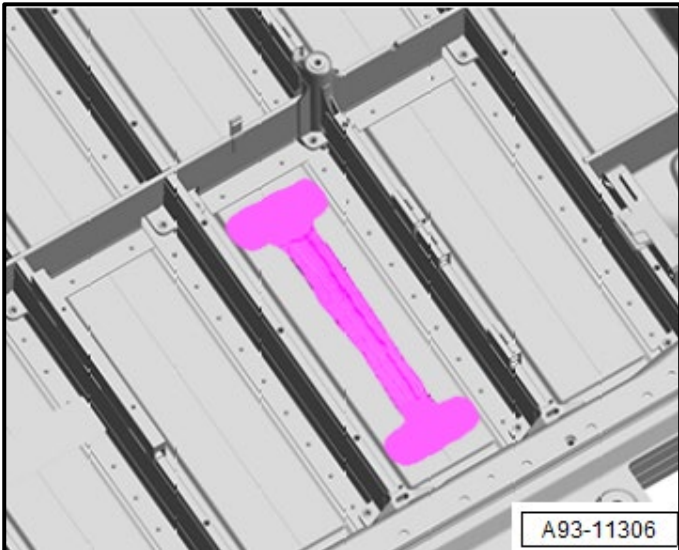

Installing new cell module(s):

- Refer to the ELSA Repair Manual for cell module installation:
 - *Repair manual > Motor > Electric Drive Motor 0EF > 93 Electric drive > High-Voltage Battery Components > Battery Module, Installing.*
- Note the following when installing a new cell module:
 - Double check the expiration date of the heat paste before applying.
 - Before applying the heat paste to the battery housing, release a small amount through the applicator on a piece of paper to ensure the paste is mixing properly.
 - Apply the specified amount of two-part thermal compound into the battery housing per the repair manual instructions.

Part Number	Part Description
D -G00-020-M2	Heat Paste (qty. 1 per cell module)

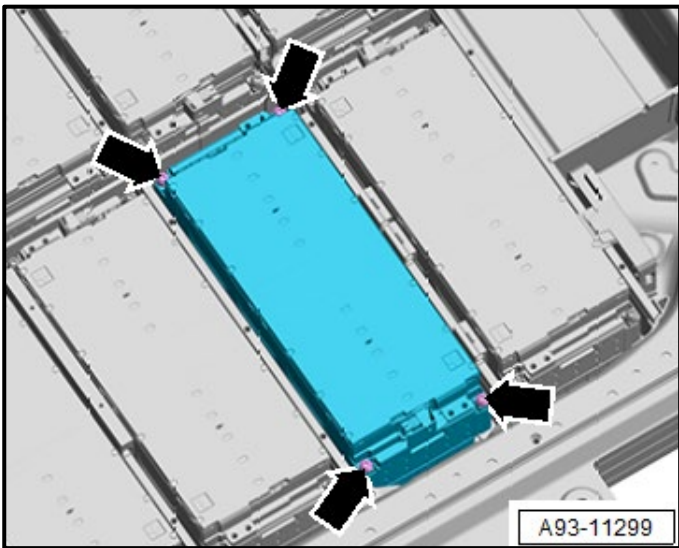

- Tighten new bolts <arrows> per the ELSA Repair Manual:
 - *Repair manual > Motor > Electric Drive Motor 0EF > 93 Electric drive > High-Voltage Battery Components > Component Location Overview - Battery Modules > Component Location Overview - Battery Modules, 95 kWh / 115 kWh.*

Part Number	Part Description
WHT-009-516	Bolt with washer (qty. 4 per cell module)

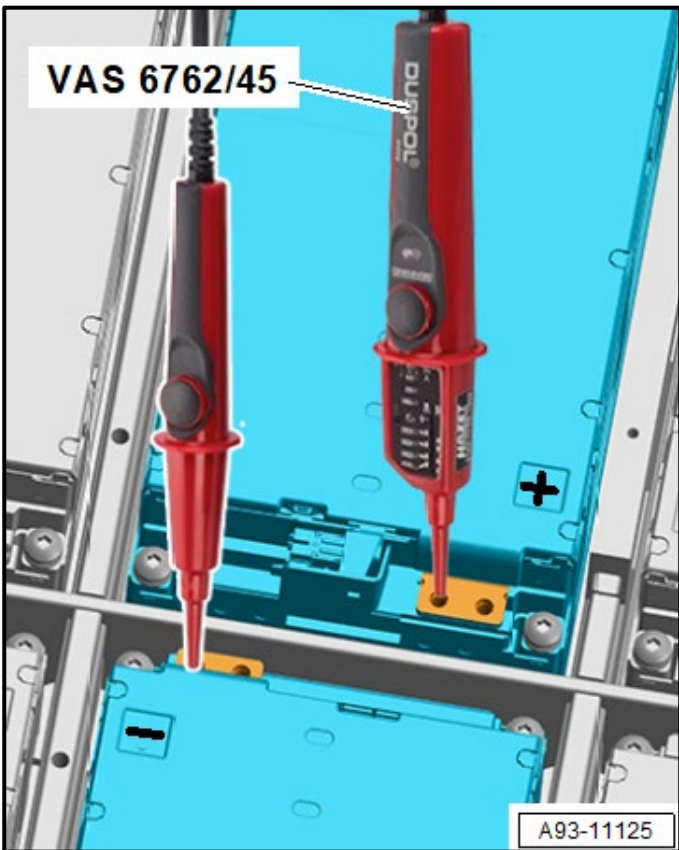

⚠ DANGER

Incorrect installation of battery modules and module connectors.
Short circuit electric arc can cause severe bodily or fatal injuries.

- Check the battery modules and module connectors for correct installation.
- Only continue with the procedure when there is no voltage in between the battery terminals.
- Pay very close attention to the Repair Manual steps outlining the use of the -VAS6762/45-.

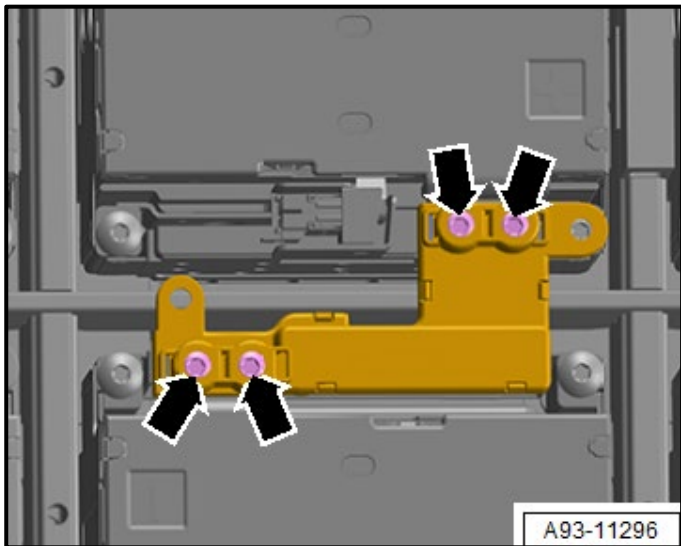

- If the voltage measurement is ok, install the battery connector immediately.
- Tighten the bolts <arrows> per the ELSA Repair Manual:
 - *Repair manual > Motor > Electric Drive Motor 0EF > 93 Electric drive > High-Voltage Battery Components > Component Location Overview - Battery Connector > Component Location Overview - Battery Connectors, 95 kWh / 115 kWh.*
- Continue with reassembly.

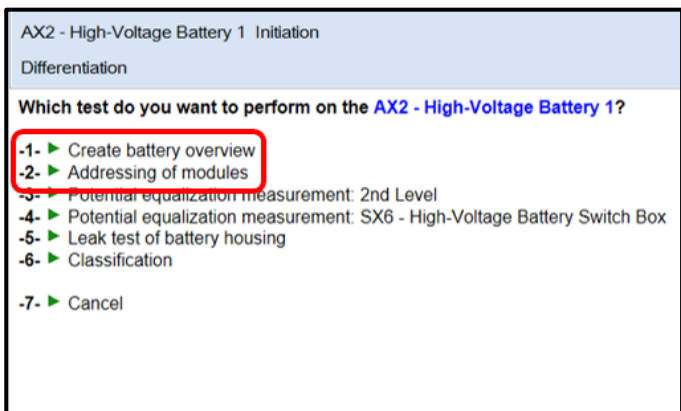

High-voltage battery preliminary operation:

⚠
DANGER

There is a risk of fatal injury due to high voltage. Severe bodily injury or death by electrocution or electric arcs is possible.

Pay very close attention to the Repair Manual steps.

- Perform the steps below in conjunction with following Guided Function test plans:
 - “008C – Initiation > -1- Create battery overview”.
 - “008C – Initiation > -2- Addressing of modules”.
- Refer to the ELSA Repair Manual for high-voltage battery preliminary operation:
 - *Repair manual > Motor > Electric Drive Motor 0EF > 93 Electric drive > High-Voltage Battery Components > High-Voltage Battery Preliminary Operation > High-Voltage Battery Preliminary Operation, Preparing for Calibration - 95 kWh / 115 kWh*
 - *Repair manual > Motor > Electric Drive Motor 0EF > 93 Electric drive > High-Voltage Battery Components > High-Voltage Battery Preliminary Operation > High-Voltage Battery Preliminary Operation - 95 kWh / 115 kWh.*

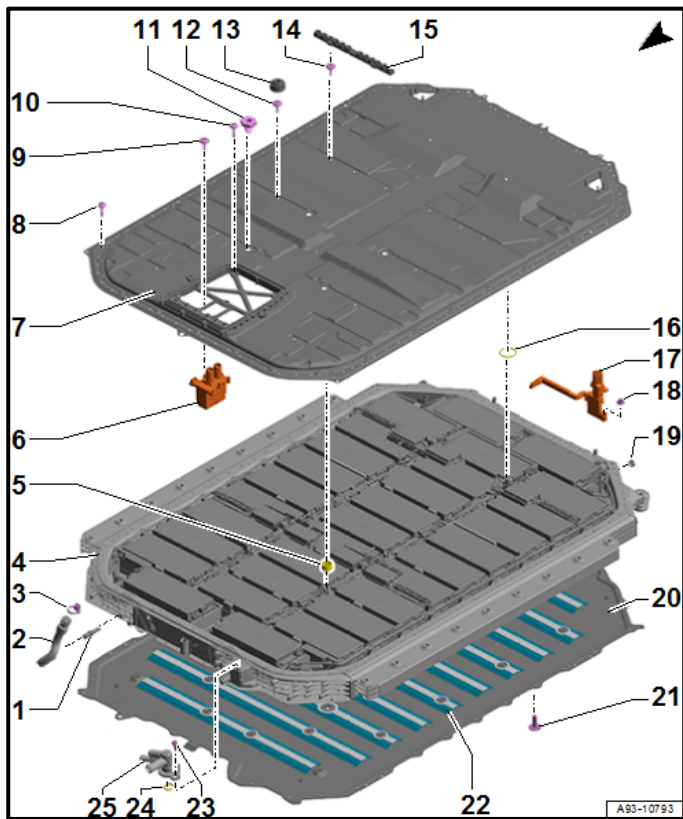

Install the high-voltage battery cover(s):

- Refer to the ELSA Repair Manual for battery cover installation:
- **Layer 1 battery cover installation:**
 - *Repair manual > Motor > Electric Drive Motor 0EF > 93 Electric drive > High-Voltage Battery Components > Battery Housing Cover, Removing and Installing > Cover for Battery Housing Layer 1, Removing and Installing, 95 kWh / 115 kWh.*
- Torque all the high-voltage battery cover bolts per the ELSA Repair Manual:
 - *Repair manual > Motor > Electric Drive Motor 0EF > 93 Electric drive > High-Voltage Battery Components > Overview - Removed High-Voltage Battery > Overview - Removed High-Voltage Battery, 95 kWh / 115 kWh.*
- Use new hardware when specified by the repair manual.

Part Number	Part Description
WHT-008-659	Perimeter bolt (qty. 95)
WHT-008-738 A	Center bolts (qty. 13)
N -101-961-07	Bolt (qty. 18)
N -906-132-01	O-ring (qty. 2)
D -450-P00-M2	Butyl sealing cord (qty. 2)
4KE-801-332	Damper (qty. 4)
4KE-801-557	Banjo bolt (qty. 4)
4KE-805-696	Damper (qty. 2)
4KE-915-433	Seal (version with SX6 seal insert)
G -052-567-A2	Grease (version with SX6 seal insert)

! NOTE

Before layer 2 is installed, a leak test is required. See the leak test instructions for layer 1 below.

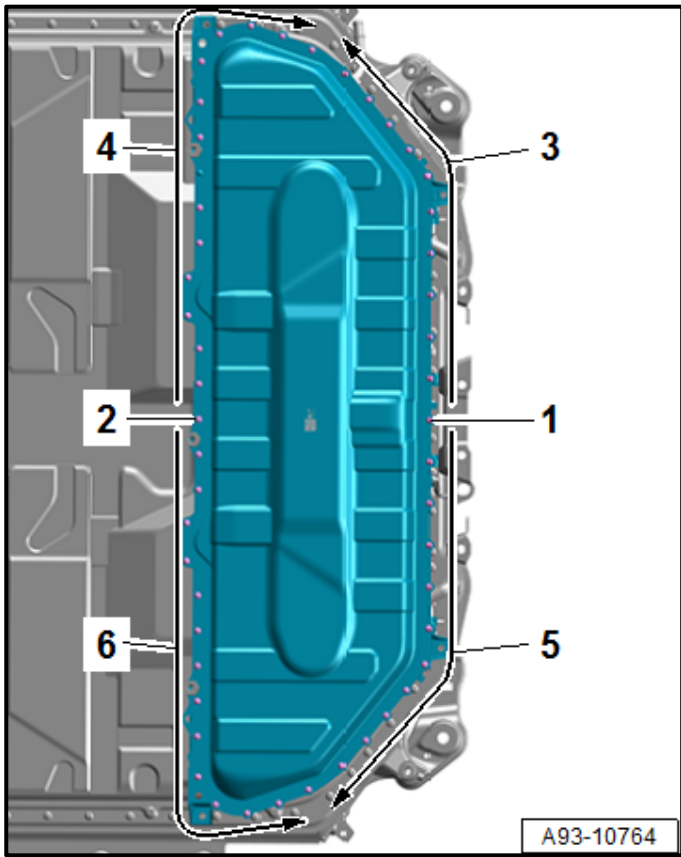

- **Layer 2 battery cover installation:**

- *Repair manual > Motor > Electric Drive Motor 0EF > 93 Electric drive > High-Voltage Battery Components > Battery Housing Cover, Removing and Installing > Cover for Battery Housing Layer 2, Removing and Installing, 95 kWh / 115 kWh.*
- Torque all the high-voltage battery cover bolts per the ELSA Repair Manual:
 - *Repair manual > Motor > Electric Drive Motor 0EF > 93 Electric drive > High-Voltage Battery Components > Overview - Removed High-Voltage Battery > Overview - Removed High-Voltage Battery, 95 kWh / 115 kWh.*
- Use new hardware when specified by the repair manual.

Part Number	Part Description
4KE-915-434	Seal (qty. 2)
N -106-847-01	Perimeter bolts (qty. 50)
D -450-P00-M2	Butyl sealing cord (qty. 1)

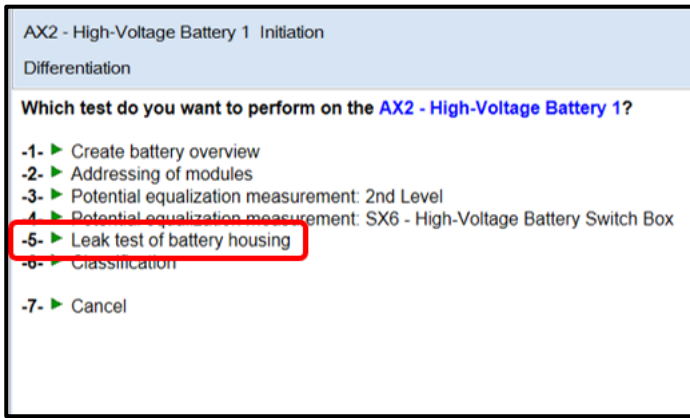

Perform high-voltage battery leak test:

- Perform the steps below in conjunction with the test plan, “008C – Initiation > select option: Leak test of battery housing.”
- Perform a leak test of the high-voltage battery per the ELSA Repair Manual:

Part Number	Part Description
12E-915-754	Pressure relief valve (qty.8)
G -052-567-A2	Grease

• **Leak test preparation:**

- *Repair manual > Motor > Electric Drive Motor 0EF > 93 Electric drive > High-Voltage Battery Unit > High-Voltage Battery 1 AX2 Leak Test > Testing Tools, Cleaning and Checking.*
- *Repair manual > Motor > Electric Drive Motor 0EF > 93 Electric drive > High-Voltage Battery Unit > High-Voltage Battery 1 AX2 Leak Test > Preparing for Calibration - High-Voltage Battery Leak Test, Part 1, 95 kWh / 115 kWh.*
- *Repair manual > Motor > Electric Drive Motor 0EF > 93 Electric drive > High-Voltage Battery Unit > High-Voltage Battery 1 AX2 Leak Test > Preparing for Calibration - High-Voltage Battery Leak Test, 71 kWh, 95 kWh, 115 kWh Part 2.*

• **Layer 1 leak test:**

- *Repair manual > Motor > Electric Drive Motor 0EF > 93 Electric drive > High-Voltage Battery Unit > High-Voltage Battery 1 AX2 Leak Test > Battery Housing Layer 1 and 2 Leak Test, 95 kWh / 115 kWh.*

• **Layer 2 leak test:**

- *Repair manual > Motor > Electric Drive Motor 0EF > 93 Electric drive > High-Voltage Battery Unit > High-Voltage Battery 1 AX2 Leak Test > Battery Housing Layer 2 Leak Test, 95 kWh / 115 kWh.*

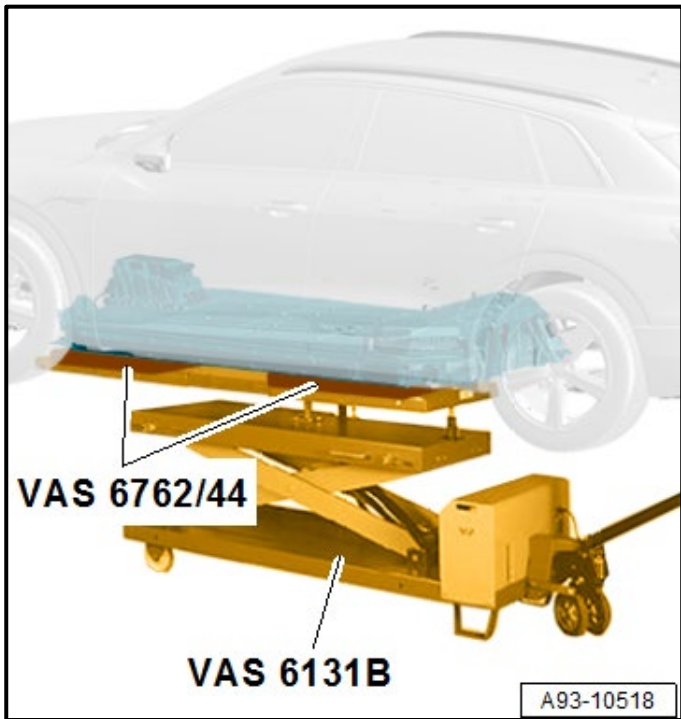

Re-install high-voltage battery:

- Installation is the reverse order of removal.
- See the ELSA Repair Manual: *Repair manual > Motor > Electric Drive Motor 0EF > 93 Electric drive > High-Voltage Battery Unit > High-Voltage Battery 1 AX2, Removing and Installing.*
- Torque the bolts for the high-voltage battery per the ELSA Repair Manual, using new bolts where specified:
 - *Repair manual > Motor > Electric Drive Motor 0EF > 93 Electric drive > High-Voltage Battery Unit > Overview - Installed High-Voltage Battery > Overview - Installed High-Voltage Battery, 95 kWh / 115 kWh*

Part Number	Part Description
N -910-661-01	Bolt (qty. 18)
N -912-461-01	Bolt (qty. 2)
N -912-721-01	Bolt (qty. 2)

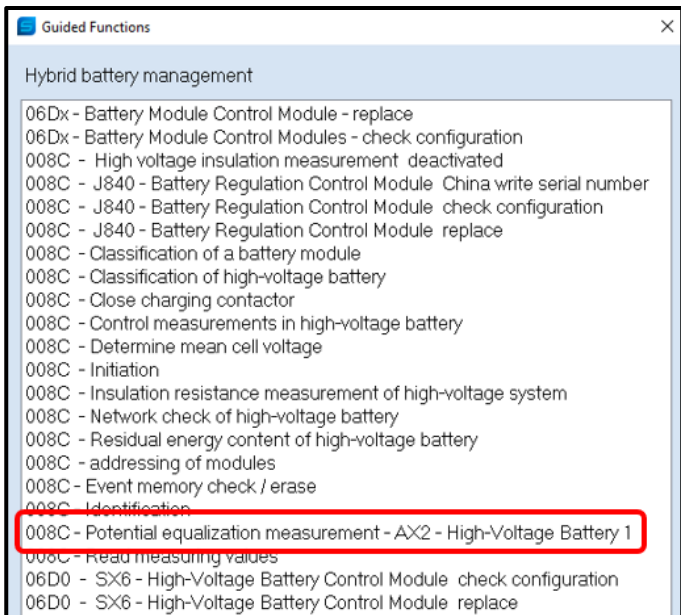

Perform potential equalization measurement:

- See the ELSA Repair Manual: *Repair manual > Motor > Electric Drive Motor 0EF > 93 Electric drive > Potential Equalization Cables > Potential Equalization Measurement.*
- Perform these steps in conjunction with Guided Function test plan, "008C - Potential equalization measurement - AX2 - High-Voltage Battery 1".

Tests in current test plan	
Status	Tests (sorted according to chances of success)
>	J533 - Sequence error during operating mode setting - high voltage
>	J1050 - External charging infrastructure
	0001 - Check warranty info
	008C - Classification of high-voltage battery
	008C - Classification of a battery module
	008C - Initiation
	Establish high-voltage de-energization
	High-voltage re-energization

Re-energize the high-voltage system:

DANGER

There is a risk of fatal injury due to high voltage. Electrocutation by direct contact or electric arc can cause severe bodily injury or fatal injury.

Have a high-voltage technician or a high-voltage expert bring the high-voltage system back into service.

- Reference the ELSA Repair Manual:
 - *Repair manual > Motor > Electric Drive Motor 0EF > 93 Electric drive > High-Voltage System, Re-Energizing.*
 - Perform these steps in conjunction with the test plan, “High-voltage re-energization”.

Thermal management	
	00C5 - Adaptation
	00C5 - Basic setting complete
	00C5 - Bleed cooling circuit
	00C5 - Check DTC memory
	00C5 - Compressor break-in, automatic start
	00C5 - Discharge A/C circuit, evacuate and charging
	00C5 - Erase DTC memory
	00C5 - Fill cooling circuit
	00C5 - Flush refrigerant circuit
	00C5 - Identification
	00C5 - Output Diagnostic Test Mode (DTM)
	00C5 - Potential Equalization Measurement, Electrical A/C Compressor -V470-
	00C5 - Potential Equalization Measurement, High-Voltage Heater (PTC) -Z115-
	00C5 - Potential Equalization Measurement, High-Voltage Heater 2 (PTC) -Z190-

Fill and bleed the cooling system:

WARNING

Risk of damaging the assemblies due to insufficiently filling or bleeding.

- Never move or tow the vehicle without the cooling system full and the bleeding performed.
 - Bleed the cooling system even if only slightly filling after repair.
- Perform the steps below in conjunction with the following Guided Function test plans:
 - “00C5 - Fill cooling circuit”.
 - “00C5 – Bleed cooling circuit”.
 - Fill and bleed the cooling system per the ELSA Repair Manual:
 - *Repair manual > Motor > Electric Drive Motor 0EF > Cooling System/Coolant > Filling and Bleeding the Coolant > Coolant, Filling and Bleeding, with VAS 531 011.*

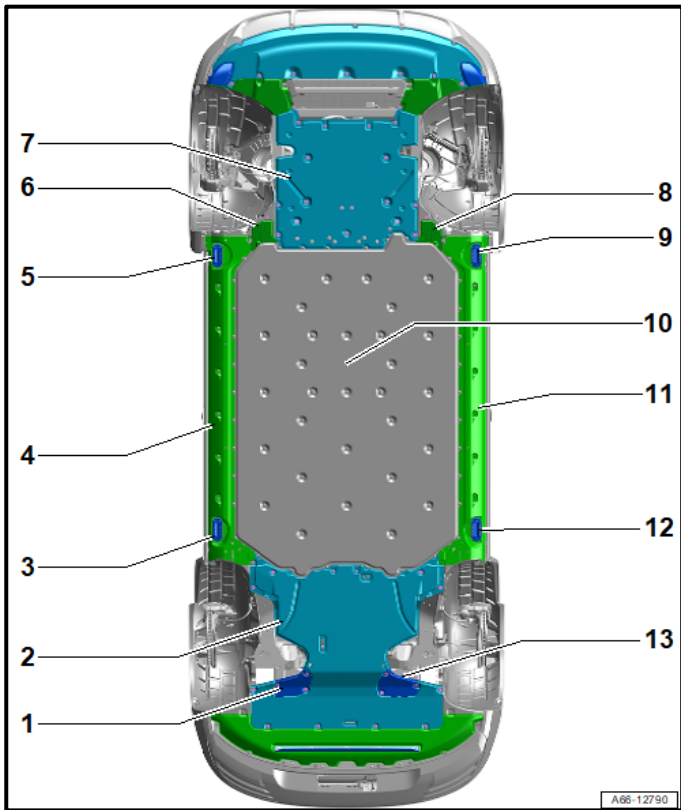

Reinstall underbody covers and impact guard:

- Installation is the reverse order of removal while noting the following:
 - Torque the impact guard per the ELSA Repair Manual: *Repair manual > Chassis > Suspension, Wheels, Steering > 40 Front Suspension > Overview – Subframe.*
 - Torque the underbody trim panels per the ELSA Repair Manual: *Repair manual > Body > Body Exterior > 66 Exterior Equipment > Underbody Trim Panel > Overview – Underbody Trim Panels.*
- Use new hardware when specified by the repair manual.
- Replace any damaged fasteners as needed.

Part Number	Part Description
N -106-421-04	Impact guard bolt (qty. 2)
N -911-407-01	Underbody trim bolt (qty. 2)
N -911-900-02	Underbody trim bolt (qty. 2)

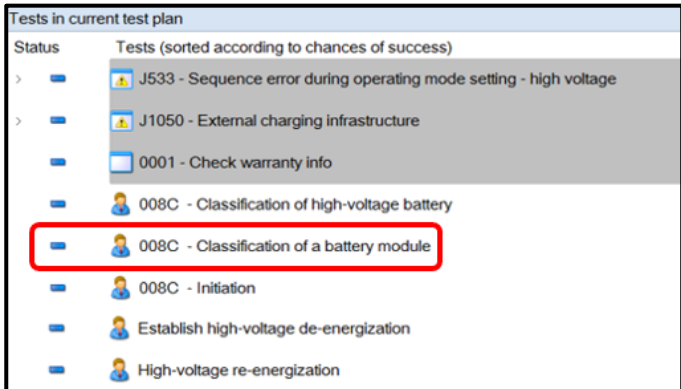

Perform classification of removed cell module(s):

CAUTION

There is danger of a health risk due to poisonous vapors, dust, and fluids.
 Never work on high-voltage batteries that have a short circuit.

CAUTION

There is a risk of burns due to a hot high-voltage battery. It is possible to burn hands.
 Wear safety gloves.

- Perform the steps below in conjunction with the test plan “008C - Classification of a battery module”.
- Classify the battery module per the ELSA Repair Manual:
 - *Repair manual > Motor > Electric Drive Motor 0EF > 93 Electric drive > High-Voltage Battery Components > Battery Module, Visual Inspection and Classification.*

Proceed to Section E

Section E – Final Steps Before Returning Vehicle to Customer



REMOVE sticker(s) (if present) from charging ports and near MMI display:

- Remove the sticker from the charging ports and from near the MMI and clean any adhesive residue.

Proceed to Section F



Section F – Campaign Completion Label

Install Campaign Completion Label

- Fill out and affix Campaign Completion Label, part number CAMP 010 000, next to the vehicle emission control information label.

 **TIP**

Ensure Campaign Completion Label does not cover any existing label(s).

If one or more modules required replacement:

- US DEALERS - Proceed to Section G
- CANADIAN DEALERS - Proceed to Section H

Section G - Parts Return/Disposal – US DEALERS ONLY

High-Voltage Battery Module(s):

Refer to the latest instructions for high-voltage battery recycling, found in Elsa2Go: *Elsa2Go-> Infomedia->Service References->Electric Vehicle Category ->“HV Battery Recycling Program Guide”*

All other parts:

Properly store (retain), destroy or dispose of removed parts in accordance with all state/province and local requirements, unless otherwise indicated and/or requested through the Warranty Parts Portal (WPP).

Section H - Parts Return/Disposal – CANADIAN DEALERS ONLY

High-Voltage Battery Module(s):

Refer to the latest version of TSB 2062871.

All other parts:

Properly store (retain), destroy or dispose of removed parts in accordance with all state/province and local requirements, unless otherwise indicated and/or requested through the Part Destruction and Core Disposition Report for Canada.