

Safety Recall

Code: 93V2



Subject
Document History

Interim Monitoring Program for High-Voltage Battery Modules (Online Vehicles)

| Date | Summary |
|------------|---|
| 05/09/2025 | Added claiming for leak test before opening the HV battery. |
| 01/22/2025 | Updated claiming for battery module balancing. Updated tool list with latest cell balancer tool number. Updated work instructions for battery module balancing. |
| 09/18/2024 | Improved online monitoring will provide the ability to define the specific module location if a faulty module is detected. In these instances, a criteria equal to the specific module position will be added. VINs assigned J* or H* criteria will still require a TAC case to determine which module position requires replacement. Claiming and repair instructions are updated. Removed requirement for final GFF log with all MVB's to be sent at the end of repairs. Information about new criteria 03 added. |
| 03/20/2024 | Updated parts and claiming tables for clarity |
| 03/08/2024 | Updated loaner claiming instructions. Updated measured value block requirements for balancing cell modules. |
| 02/27/2024 | Updated parts table. Added link to dealer webinar recording. |
| 02/16/2024 | Original publication |

Affected Vehicles

| Country | Beginning Model Year | Ending Model Year | Vehicle | Vehicle Count |
|---------|----------------------|-------------------|--------------------------|---------------|
| USA | 2019 | 2022 | E-TRON QUATTRO | 18,083 |
| USA | 2020 | 2022 | E-TRON SPORTBACK QUATTRO | 4,407 |

Check Campaigns/Actions screen in Elsa on the day of repair to verify that a VIN qualifies for repair under this action. Elsa is the only valid campaign inquiry & verification source.

- ✓ Campaign status must show "open."
- ✓ If Elsa shows other open action(s), inform your customer so that the work can also be completed at the same time the vehicle is in the workshop for this campaign.

Problem Description

A potentially critical self-discharge condition exists in certain high-voltage battery modules that, in some instances, may lead to thermal overload, possibly resulting in smoke or a fire. A high-voltage battery overheating increases the risk of a fire.

Interim Monitoring Program for HV Battery Modules

Customers with online data collection activated in their vehicles will be monitored under Audi's Online Field Monitoring program. Online data collection is active unless Privacy Mode is engaged in the vehicles. Audi of America's data collection practices for purposes of monitoring for vehicle safety and other purposes are described in our privacy statement, at audiusa.com/privacy. Please see the Owner's Manual to learn about the vehicle's available data collection choices through Privacy Mode.

As long as a vehicle has online data collection activated, Audi will retrieve and analyze data from the HV battery modules in the vehicle, as long as the vehicle is driven and Privacy Mode is not engaged. While this is not a recall remedy, it is an interim step to help monitor the vehicle's HV battery modules until the recall remedy becomes available. Once the recall remedy becomes available, this monitoring program will be discontinued.

- If, at the time the interim owner letter was mailed, our records show that online data collection was activated for a vehicle, and Audi's Online Field Monitoring program records show that the HV battery modules in the vehicle are operating according to factory specifications, there is nothing an owner needs to do at this time.
- If Audi's Online Field Monitoring program identifies a HV battery module needing replacement, Audi will notify the owner via first-class mail, and the owner will need to schedule a service appointment with an authorized Audi dealer. The dealer will order the necessary parts and perform the replacement FREE of charge. This work can take up to three days to complete, depending on the number of HV battery modules requiring replacement.
- Once the affected module(s) replacement has been completed, Audi will continue to retrieve and analyze data from the HV battery modules in the vehicle, as long as the vehicle is driven and Privacy Mode is not engaged. Should another module require replacement before the recall remedy becomes available, Audi will notify the owner via first-class mail, and they will need to schedule FREE module replacement with an authorized Audi dealer.

Precautions

For vehicles where Audi's Online Field Monitoring program records show that one or more of the HV battery modules in a vehicle requires replacement, as a precaution, Audi recommends setting the maximum battery charge to 80%. This is an important measure to help protect the high-voltage battery modules in the vehicle until the faulty module(s) can be repaired.

Once the faulty module(s) have been repaired by an authorized Audi dealer, owners may resume charging normally.

The vehicle owner's manual contains important information about charging the vehicle, and regarding the vehicle's warning lights and messages. We encourage owners and anyone who drives the vehicle to review the owner's manual to become familiar with charging procedures, and with the types of vehicle indicators, warnings and messaging they may see.

Code Visibility

On December 22, 2023 the campaign code was applied to affected vehicles.

Interim Owner Notification

Interim owner notification will take place in February 2024. Interim owner letter examples are included in this bulletin for your reference.

Additional Information

Please alert everyone in your dealership about this action, including Sales, Service, Parts and Accounting personnel. Contact Warranty if you have any questions.

IMPORTANT REMINDER ON VEHICLES AFFECTED BY SAFETY & COMPLIANCE RECALLS

New Vehicles in Dealer Inventory: It is a violation of federal law for a dealer to deliver a new motor vehicle or any new or used item of motor vehicle equipment (including a tire) covered by this notification under a sale or lease until the defect or noncompliance is remedied. By law, dealers must correct, prior to delivery for sale or lease, any vehicle that fails to comply with an applicable Federal Motor Vehicle Safety Standard or that contains a defect relating to motor vehicle safety.

Pre-Owned Vehicles in Dealer Inventory: Dealers should not deliver any pre-owned vehicles in their inventory which are involved in a safety or compliance recall until the defect has been remedied.

Parts Information

IMPORTANT

Every module identified for replacement with the new online monitoring parameters will be assigned criteria designating which module position requires replacement.

Example:

32 = Module position 32 requires replacement.

J1 and 21 = One module with part number 4KE-915-591-J requires replacement, and a TAC case is required to determine the position of the J index module to be replaced, AND module position 21 also requires replacement.

VINs may still be assigned criteria J1 through J*, and H1 through H*, which are associated with the module part number for every module known to be replaced.

The J1 through J*, and H1 through H* criteria also indicate how many of each module part number are known to need replacement.

Example:

J1 = one module with part number 4KE-915-591-J requires replacement

H1 = one module with part number 4KE-915-591-H requires replacement

If more than one module requires replacement, additional criteria associated with the part number will also be assigned.

Example:

J1 and J2 = two modules with part number 4KE-915-591-J require replacement

J1 and H2 = one module with part number 4KE-915-591-J requires replacement and one module with part number 4KE-915-591-H requires replacement

Vehicles may have multiple modules requiring replacement. A criteria will be assigned for each module needing replacement.

Example:

A car needs five "J" index cell modules. The VIN will be assigned J1, J2, J3, J4 and J5.

**The following parts are needed when the vehicle requires a cell module replacement.
Order as needed depending on the quantity and position of the module being replaced.**

| Criteria | Quantity | Part Number | P.O.C. Part Description | Ordering Method (see description below) |
|---|-----------------|-------------------|--|--|
| J1 thru J*, M1, M3, M5, M7, 10, 11, 13, 21, 23, 26, 27, 30, 31, 34, 35 | As needed | 4KE-915-591-J | BATTERY | VIN to Order |
| H1 thru H*, M2, M4, M6, M8, M9, 12, 14, 15, 16, 17, 18, 19, 20, 22, 24, 25 28, 29, 32 33, 36 | As needed | 4KE-915-591-H | BATTERY | VIN to Order |
| ALL | 1 per module | D -G00-020-M2 | Paste | UOL |
| | 4 per module | WHT-009-516 | Screw | Free Order |
| | 8 | 12E-915-754 | VALVE | Free Order |
| | 1 | 4KE-121-809-B | Sealant | Free Order |
| | 4 | 4KE-801-332 | SOUND ABS | Free Order |
| | 4 | 4KE-801-557 | BANJO BOLT | Free Order |
| | 2 | 4KE-805-696 | SOUND ABS | Free Order |
| | 1 | 4KE-915-433 | GASKET | Free Order |
| | 2 | 4KE-915-434 | GASKET | Free Order |
| | 3 | 80A-886-373 | GROMMET | Free Order |
| | 3 | D -450-P00-M2 | BUTYL TAPE | UOL |
| | 1 | G -052-567-A2 | GREASE | UOL |
| | 1 | G -12E-100-1G CON | G12 EVO Coolant Concentrate (US Dealers) | Free Order |
| | 1 | G -12E-100-2G CON | G12 EVO Coolant Concentrate (Canadian Dealers) | Free Order |
| | 18.00 | N -101-961-07 | Screw | Free Order |
| 2 | N -106-421-04 | BOLT | Free Order | |

Continued on next page

| Criteria | Quantity | Part Number | P.O.C. Part Description | Ordering Method (see description below) |
|----------|----------|---------------|-------------------------|--|
| ALL | 50 | N -106-847-01 | BOLT | Free Order |
| | 2 | N -906-132-01 | SEAL RING | Free Order |
| | 18 | N -910-661-01 | BOLT | Free Order |
| | 2 | N -911-407-01 | BOLT | Free Order |
| | 2 | N -911-900-02 | BOLT | Free Order |
| | 2 | N -912-721-01 | SCREW | Free Order |
| | 95 | WHT-008-659 | BOLT | Free Order |
| | 13 | WHT-008-738-A | BOLT | Free Order |

| | |
|---|--|
| Parts Control Type: VIN to Order | If parts are needed to support a vehicle repair: <ul style="list-style-type: none"> • US Dealers - use AVA • CAN Dealers - contact the Parts Specialists via phone (800-767-6552), email (VWoAPartsSpecialists@vw.com), or chat/text with the VIN to order |
|---|--|

| | |
|--|---|
| Parts Control Type: Upper Order Limit (UOL) | Parts will be managed with a weekly Upper Order Limit. Please see Parts On Command (POC) for your Upper Order Limit quantity. |
|--|---|

| | |
|---|-------------------------------------|
| Parts Control Type: Free Order | Parts will be managed by Free Order |
|---|-------------------------------------|

| | |
|---|---|
| Initial Allocation: NO | There will be no parts allocation. Please reference the Repair Projection Tool (below) to view your potential VIN population. |
|---|---|

| |
|--|
| NOTE |
| Your dealer's Estimated Remaining Repairs by campaign can be found in Parts on Command. Click on "View Campaign List" and review the Estimated Remaining Repairs column. |

| |
|--|
| NOTE |
| Campaign parts should always be ordered as per the parts information in this circular. The ordering system will supersede the part, if applicable. |

Claim Entry Instructions

The labor times listed here may differ from the labor operations and labor times listed in ELSA.

After campaign has been completed, enter claim as soon as possible to help prevent work from being duplicated elsewhere. Attach the Elsa screen print showing action open on the day of repair to the repair order.

If customer refused campaign work:

- ✓ U.S. dealers: Submit the request through Audi Warranty Online under the Campaigns/Update option.
- ✓ Canada dealers: Upload the repair order [signed by customer] to Audi WIN/Operations/Campaign Closure.

| | |
|--------------------------|---|
| Service Number | 93V2 |
| Damage Code | 0099 |
| Parts Vendor Code | 002 |
| Claim Type | Sold vehicle: 7 10 Unsold vehicle: 7 90 |
| Causal Indicator | Mark labor as causal if high voltage battery is OK Mark BATTERY* as causal if one or more cell modules require replacement |
| Vehicle Wash | Do not claim wash/loaner under this action |
| Vehicle Loaner | See special claiming instructions for rental/loaner claiming. <i>NOTE: A 2nd claim must be entered for rental/loaner claiming</i> |

**Before the final software remedy is available, inspections and repairs must be claimed correctly.
Failure to do so will cause issues for future claims.**

Overview of criteria:

01 – Claimed only on first in-dealer visit when a module is replaced

02 – Claimed only if a vehicle returns for an additional module replacement after an initial module replacement, *before* the software is available

03 – Claimed only if a vehicle returns for an additional module replacement after a previous module replacement, *before* the software is available

GE – Claimed only when the software update is completed (not yet available)

IMPORTANT: the software update is not available at this time. Criteria GE can only be claimed once the software update is available. DO NOT enter criteria GE during the monitoring period. Claiming GE will close the campaign.

When the final remedy becomes available, vehicles will be assigned only criteria GE

M1 through M9 – Module positions 1 (M1) through 9 (M9)

10 through 36 – Module positions 10 through 36

LABOR CLAIMING INSTRUCTIONS

Enter only 01 or 02 or 03 on the claim according to which visit the vehicle is in for.

Vehicles may also have J* / H* criteria assigned. These will also have to be entered on the claim when module(s) are replaced.

Vehicles may also have criteria M1 through M9 and/or 10 through 36 assigned. These designate which module position(s) require replacement and will also have to be entered on the claim when module(s) are replaced.

| | | | |
|----------------------|--|-------------------|----------------------------|
| Criteria I.D. | 01 - Enter this criteria if the vehicle comes in for the first pre-determined module replacement. | | |
| | Perform test plan to check for cell modules that require replacement. | | |
| | | | |
| | Labor Op | Time Units | Description |
| | 9303 06 99 | 35 | Check high voltage battery |

| | | | |
|----------------------|---|-------------------|----------------------------|
| Criteria I.D. | 02 - Enter this criteria if the vehicle returns for additional module replacement. | | |
| | Perform test plan to check for cell modules that require replacement. | | |
| | | | |
| | Labor Op | Time Units | Description |
| | 9303 01 99 | 35 | Check high voltage battery |

| | | | |
|----------------------|--|-------------------|----------------------------|
| Criteria I.D. | 03 - Enter this criteria if the vehicle returns for additional module replacement after a previous module replacement | | |
| | Perform test plan to check for cell modules that require replacement. | | |
| | | | |
| | Labor Op | Time Units | Description |
| | 9303 01 99 | 35 | Check high voltage battery |

| | | | |
|----------------------|-------------------------------|--|--|
| Criteria I.D. | GE – CANNOT BE CLAIMED | | |
|----------------------|-------------------------------|--|--|

Continued on next page

| | | | |
|---------------------------|---|------------------------------------|--|
| AND (if necessary) | If module(s) require replacement, claim <u>all applicable</u> J* / H* criteria along with 01 or 02 or 03 AND/OR all applicable M1 through M9 and/or 10 through 36 criteria DO NOT claim criteria GE | | |
| | ADD as needed if cell module(s) require replacement | | |
| | | | |
| | Labor Op | Time Units | Description |
| | 2706 89 50 | See ELSA | Connected battery charger |
| | 0150 00 60 | Time stated on diagnostic protocol | GFF/Guided functions |
| | 9301 19 50 | See ELSA | Battery module remove+reinstall (level 1) |
| | 9301 19 51 | See ELSA | Battery module remove+reinstall (level 1 – each <u>additional</u> module) |
| | 9301 19 52 | See ELSA | Battery module remove+reinstall (level 2) |
| | 9301 19 53 | See ELSA | Battery module remove+reinstall (level 2 – each <u>additional</u> module) |
| | 9301 89 50 | See ELSA | Battery module charge (can be claimed multiple times) |
| | <i>NOTE: LO 9301 89 50 should only be claimed multiple times is only claimed if adjacent cell modules controlled by the same battery module control module also required charging/discharging</i> | | |
| | 9302 03 50 | See ELSA | Battery housing measure (potential equalization) |
| | 9302 19 50 | See ELSA | Battery housing remove+reinstall (cover – level 2) (Only if level 1 does not need to be opened) |
| | 9302 19 51 | See ELSA | Battery housing remove+reinstall (cover – level 2) (e-tron S ONLY) (Only if level 1 does not need to be opened) |
| | 9302 19 60 | See ELSA | Battery housing remove+reinstall (cover – level 1) |
| | 9302 19 62 | See ELSA | Battery housing remove+reinstall (cover – level 1) (e-tron S ONLY) |
| | 9303 01 52 | See ELSA | High voltage battery check (classification) |

Continued on next page

| Labor Op | Time Units | Description |
|-----------------|-------------------|---|
| 9303 01 50 | See ELSA | High voltage battery check (leak test – level 1 ONLY) (Only if level 1 needs to be opened) |
| 9303 01 54 | See ELSA | High voltage battery check (leak test – level 1 and level 2) |
| 9303 01 58 | See ELSA | High voltage battery check (initial set up – level 1 and level 2) |
| 9303 01 62 | See ELSA | High voltage battery check (leak test – before opening HV battery) |
| 9303 19 00 | See ELSA | High voltage battery remove+reinstall |
| 9303 19 02 | See ELSA | High voltage battery remove+reinstall (e-tron S ONLY) |
| 1938 35 50 | See ELSA | Coolant inspect+add |
| 9310 83 50 | See ELSA | Disable HV system voltage deactivate and activate (diagnostic activation HV system) |
| 9327 19 50 | See ELSA | Switch box high-voltage battery remove+reinstall (Only if level 1 needs to be opened) |
| 9325 19 50 | See ELSA | ECM Battery Management System remove+reinstall |
| 7057 19 05 | See ELSA | A-pillar trim remove+reinstall (lower) |
| 9301 01 50 | See ELSA | Battery module check (classification) |
| 9301 00 50 | See ELSA | Battery module – Package critical HV-ECM (only if test plan indicated module was in critical state) |

Continued on next page

PARTS CLAIMING INSTRUCTIONS

| | | | |
|----------------------|---|--------------------------------|--|
| Criteria I.D. | If module(s) require replacement, claim <u>all applicable</u> J* / H* criteria along with 01 or 02 or 03 AND/OR all applicable M1 through M9 and/or 10 through 36 criteria DO NOT claim criteria GE | | |
| | Claim the following parts as needed if one or more modules require replacement. | | |
| | Quantity | Part Number | Description |
| | 8.00 | 12E915754 | VALVE |
| | 1.00 | 4KE121809B | Sealing |
| | 4.00 | 4KE801332 | Damping |
| | 4.00 | 4KE801557 | BANJO BOLT |
| | 2.00 | 4KE805696 | SOUND ABS |
| | 1.00 | 4KE915433 | GASKET |
| | 2.00 | 4KE915434 | GASKET |
| | As required | 4KE915591H | BATTERY* (module) |
| | As required | 4KE915591J | BATTERY* (module) |
| | 3.00 | 80A886373 | GROMMET |
| | 3.00 | D 450P00M2 | BUTYL TAPE |
| | 1.00 per module | D G00020M2 | Paste |
| | Up to 85.00 or Up to 4.25 | G 12E100S1 or G 12E050S0 | COOLANT (concentrate) or COOLANT (pre-mix) |
| | Up to 85.00 or Up to 170.00 | G 12E100S1 or G 12E050S0 | COOLANT (concentrate) or COOLANT (pre-mix) |
| | 1.00 | G 052567A2 | GREASE |
| | 18.00 | N 10196107 | Screw |
| | 2.00 | N 10642104 | BOLT, HEX, HD. WITH SHOULDER |
| | 50.00 | N 10684701 | OVAL HEXAGON SOCKET HEAD BOLT |
| | 2.00 | N 90613201 | ROUND SEAL |
| | 18.00 | N 91066101 | BOLT, HEX. HD. (COMBI.) |
| | 2.00 | N 91140701 | HEXAGON SOCKET OVAL HEAD BOLT (COMBI) |
| | 2.00 | N 91190002 | BOLT |
| | 2.00 | N 91272101 | SCREW |
| | 95.00 | WHT008659 | BOLT |
| | 13.00 | WHT008738A | BOLT |
| | 4.00 per module | WHT009516 | Screw |

Continued on next page

ADDITIONAL CLAIMING INSTRUCTIONS

| Vehicle Loaner (if required) | Enter vehicle loaner claim as a separate (2 nd) claim | | |
|---------------------------------|---|----------|--|
| | Claim Type | 7 MO | (letter O, not number 0) |
| | Service Number | 93V2 | |
| | Damage Code | 0010 | |
| | Parts Vendor Code | 002 | |
| | Criteria | MO | (letter O, not number 0) |
| | <i>NOTE: Criteria MO must be entered on the vehicle loaner claim. If it is not entered, the campaign will close out completely.</i> | | |
| | Outside Labor Operation | LOAN1600 | Enter dollar amount on rental/loaner invoice: US Dealers - \$50 max per day Canadian Dealers - \$60 max per day Vehicle is assigned a J* and/or H* criteria and a TAC case was required to determine which module position required replacement: (1 day maximum for waiting for evaluation results) -OR- (3 day maximum for battery repairs <u>and</u> waiting for evaluation results) Vehicle is NOT assigned a J* and/or H* criteria and NO TAC case was required to determine which module position required replacement: 2 day maximum for battery repairs |

Customer Letter Example (USA) VEHICLE MONITORING = OK

<MONTH YEAR>

<CUSTOMER NAME>

<CUSTOMER ADDRESS>

<CUSTOMER CITY STATE ZIPCODE>

This notice applies to your vehicle: <VIN>

<MODELYEAR> <BRAND> <MODEL>

NHTSA: 23V867

Audi Recall: 93V2 – High-Voltage Battery Modules

INTERIM SAFETY RECALL NOTICE FOR YOUR VEHICLE FREE AUDI ONLINE FIELD MONITORING PROGRAM – HV BATTERY MODULES

This notice is sent to you in accordance with the *National Traffic and Motor Vehicle Safety Act*. Audi has decided that a defect, which relates to motor vehicle safety, exists in certain 2019-2022 model year Audi vehicles. Our records show that you are the owner of a vehicle affected by this action.

About this recall:

A potentially critical self-discharge condition exists in certain high-voltage (HV) battery modules that, in some instances, may lead to thermal overload, possibly resulting in smoke or a fire. A high-voltage battery overheating increases the risk of a fire.

A recall remedy is not yet available.

Audi is working to make a recall remedy available as quickly as possible, and we will send you another letter once it is available. We expect to have the remedy available by the end of the 3rd quarter of 2024. The recall remedy, when available, will be performed for you free of charge.

A FREE Audi Online Field Monitoring Program for HV battery modules is available NOW for your vehicle.

Customers with online data collection activated in their vehicles will be monitored under Audi's Online Field Monitoring program. Online data collection is active unless Privacy Mode is engaged in the vehicles. Audi of America's data collection practices for purposes of monitoring for vehicle safety and other purposes are described in our privacy statement, at audiusa.com/privacy. Please see your Owner's Manual to learn about your vehicle's available data collection choices through Privacy Mode. According to our records, your vehicle has the online data collection activated.

Audi will retrieve and analyze data from the HV battery modules in your vehicle, as long as your vehicle is driven and Privacy Mode is not engaged. While this is not a recall remedy, it is an interim step to help monitor your vehicle's HV battery modules until the recall remedy becomes available. Once the recall remedy becomes available, this monitoring program will be discontinued.

At the time this letter was mailed, our records show that online data collection is activated for your vehicle, and Audi's Online Field Monitoring program records show that the HV battery modules in your vehicle are operating according to factory specifications. There is nothing you need to do at this time.

In the future, if Audi's Online Field Monitoring program identifies a HV battery module needing replacement, Audi will notify you via first-class mail, and you will need to schedule a service appointment with your authorized Audi dealer. Your dealer will order the necessary parts and perform the replacement for you FREE of charge. This work can take up to three days to complete, depending on the number of HV battery modules requiring replacement. Please keep in mind that your dealer may need additional time for the preparation of the work, as well as to accommodate their daily workshop schedule.

As a reminder, your vehicle owner's manual contains important information regarding your vehicle's warning lights and messages. We encourage you and anyone who drives your vehicle to review the owner's manual to become familiar with the types of vehicle indicators, warnings and messaging you may see.

Your safety and that of your passengers is our highest priority. We apologize for any inconvenience this letter may cause.

Sincerely,

Audi Customer Protection



Audi

Audi of America, Inc., 3800 Hamlin Road, Auburn Hills, MI 48326

If you should have any questions about this communication, please contact Audi Customer Experience at 1-800-253-2834 or via our "Contact Us" page at www.audiusa.com. If you still cannot obtain satisfaction, you may file a complaint with: The Administrator, National Highway Traffic Safety Administration, 1200 New Jersey Avenue, SE., Washington, DC 20590; or call the toll-free Vehicle Safety Hotline at 1-888-327-4236 (TTY: 1-800-424-9153); or go to <http://www.safercar.gov>.

To check your vehicle's eligibility for repair under this or any other recall/service campaign, please visit the Recall/Service Campaign Lookup tool at www.audiusa.com and enter your Vehicle Identification Number (VIN).

If you are the lessor and registered owner of the vehicle identified in this action, the law requires you to forward this letter immediately via first-class mail to the lessee within ten (10) days of receipt. If you have changed your address or sold the vehicle, please fill out the enclosed prepaid Owner Reply card and mail it to us so we can update our records.

Customer Letter Example (USA) VEHICLE MONITORING = NOT OK

<MONTHYEAR>
<CUSTOMER NAME>
<CUSTOMER ADDRESS>
<CUSTOMER CITY STATE ZIPCODE>

This notice applies to your vehicle: <VIN>
<MODELYEAR> <BRAND> <MODEL>
NHTSA: 23V867
Audi Recall: 93V2 – High-Voltage Battery Modules

INTERIM SAFETY RECALL NOTICE FOR YOUR VEHICLE HIGH-VOLTAGE BATTERY MODULE(S) REPLACEMENT NEEDED

This notice is sent to you in accordance with the *National Traffic and Motor Vehicle Safety Act*. Audi has decided that a defect, which relates to motor vehicle safety, exists in certain 2019-2022 model year Audi vehicles. Our records show that you are the owner of a vehicle affected by this action.

About this recall: A potentially critical self-discharge condition exists in certain high-voltage (HV) battery modules that, in some instances, may lead to thermal overload, possibly resulting in smoke or a fire. A high-voltage battery overheating increases the risk of a fire.

A recall remedy is not yet available. Audi is working to make a recall remedy available as quickly as possible, and we will send you another letter once it is available. We expect to have the remedy available by the end of the 3rd quarter of 2024. The recall remedy, when available, will be performed for you free of charge.

A FREE Audi Online Field Monitoring Program for HV battery modules is available NOW for your vehicle.

Customers with online data collection activated in their vehicles will be monitored under Audi's Online Field Monitoring program. Online data collection is active unless Privacy Mode is engaged in the vehicles. Audi of America's data collection practices for purposes of monitoring for vehicle safety and other purposes are described in our privacy statement, at audiusa.com/privacy. Please see your Owner's Manual to learn about your vehicle's available data collection choices through Privacy Mode. According to our records, your vehicle has the online data collection activated.

Audi will retrieve and analyze data from the HV battery modules in your vehicle, as long as your vehicle is driven and Privacy Mode is not engaged. While this is not a recall remedy, it is an interim step to help monitor your vehicle's HV battery modules until the recall remedy becomes available. Once the recall remedy becomes available, this monitoring program will be discontinued.

IMPORTANT!

Your vehicle needs HV battery module replacement NOW! →

At the time this letter was mailed, our records show that online data collection is activated for your vehicle, and Audi's Online Field Monitoring program records show that one or more of the HV battery modules in your vehicle requires replacement.

Please contact your authorized Audi dealer without delay to schedule this FREE repair as soon as possible.

Your dealer will order the necessary parts and perform the necessary HV battery module replacement(s) for you FREE of charge. This work can take up to three days to complete, depending on the number of HV battery modules requiring replacement. Please keep in mind that your dealer may need additional time for the preparation of the work, as well as to accommodate their daily workshop schedule.

Once the affected module(s) replacement has been completed, Audi will continue to retrieve and analyze data from the HV battery modules in your vehicle, as long as your vehicle is driven and Privacy Mode is not engaged. Should another module require replacement before the recall remedy becomes available, Audi will notify you via first-class mail and you will need to schedule FREE module replacement with your authorized Audi dealer.

Precautions you should take:

Because Audi's Online Field Monitoring program records show that one or more of the HV battery modules in your vehicle requires replacement, as a precaution, Audi recommends you set the maximum battery charge to 80%. This is an important measure to help protect the high-voltage battery modules in your vehicle until your dealer has repaired the faulty module(s).

Once the faulty module(s) have been repaired by your authorized Audi dealer, you may resume charging normally.

Your vehicle owner's manual contains important information about charging your vehicle, and regarding your vehicle's warning lights and messages. We encourage you and anyone who drives your vehicle to review the owner's manual to become familiar with charging procedures, and with the types of vehicle indicators, warnings and messaging you may see.

Your safety and that of your passengers is our highest priority. We apologize for any inconvenience this letter may cause.

Sincerely,

Audi Customer Protection



Audi Audi of America, Inc., 3800 Hamlin Road, Auburn Hills, MI 48326

If you should have any questions about this communication, please contact Audi Customer Experience at 1-800-253-2834 or via our "Contact Us" page at www.audiusa.com. If you still cannot obtain satisfaction, you may file a complaint with: The Administrator, National Highway Traffic Safety Administration, 1200 New Jersey Avenue, SE., Washington, DC 20590; or call the toll-free Vehicle Safety Hotline at 1-888-327-4236 (TTY: 1-800-424-9153); or go to <http://www.safercar.gov>.

To check your vehicle's eligibility for repair under this or any other recall/service campaign, please visit the Recall/Service Campaign Lookup tool at www.audiusa.com and enter your Vehicle Identification Number (VIN).

If you are the lessor and registered owner of the vehicle identified in this action, the law requires you to forward this letter immediately via first-class mail to the lessee within ten (10) days of receipt. If you have changed your address or sold the vehicle, please fill out the enclosed prepaid Owner Reply card and mail it to us so we can update our records.

Safety Precautions When Working ON the High-voltage System (additional information is also available in the ELSA Repair Manual)

DANGER

Extremely dangerous due to high voltage.

- The high-voltage system is under heavy voltage. Severe bodily injury or death by electrocution or electric arcs is possible.
- When working on the high-voltage system the high-voltage system must be de-energized.
- When performing procedures that do not directly affect the high-voltage system, in some cases it is still necessary to de-energize the high-voltage system.
- Pay attention when the high-voltage system must be de-energized. Refer to the Repair Manual
- Have a High-Voltage Technician or a High-Voltage Expert de-energize the high-voltage system.

The electric and magnetic fields are extremely dangerous.

- There are electric and magnetic fields on the high-voltage system. Death or serious injury are possible due to malfunction of active implants (for example cardiac pacemakers, insulin pumps).
- Persons with active implants may not perform procedures on the high-voltage system.

WARNING

Risk of injury - motor may start unexpectedly

It is difficult to determine whether the drive system of an electric vehicle or hybrid vehicle is active. Moving parts can trap or draw in parts of the body.

CAUTION

Risk of damage to high-voltage wiring

- Incorrect handling may result in damage to the insulation of high-voltage wires or high-voltage connectors.
- Do not support yourself on high-voltage cables or connectors.
- Never prop tools against high-voltage wiring or high-voltage connectors.
- Never bend or kink high-voltage wiring.
- Observe the coding of the high-voltage connectors when joining them up.

Safety Precautions When Working NEAR the High-voltage System (additional information is also available in the ELSA Repair Manual)

DANGER

Extremely dangerous due to high voltage.

- The voltage levels in the high-voltage system constitute a safety hazard. Danger of severe or fatal injuries from electric shock if high-voltage components or high-voltage wiring are damaged.
- Carry out a visual check of high-voltage components and high-voltage wiring.
- Never use cutting/forming tools or other sharp-edged implements.
- Never perform work using welding, brazing, thermal bonding or hot air in the area of high-voltage components and high-voltage cables.

 **DANGER**

High voltage increases the risk of fatal injury

Electrocution can cause severe bodily or fatal injury.

- For the following procedures suitable personal protective equipment must be worn.
- For the following steps two correspondingly qualified technicians must be present for the supervision.
- If necessary, a second technician can help the high-voltage expert outside of the hazardous area within their qualification.
- The personal protective equipment (PPE) must be dry and undamaged.

Repair Overview

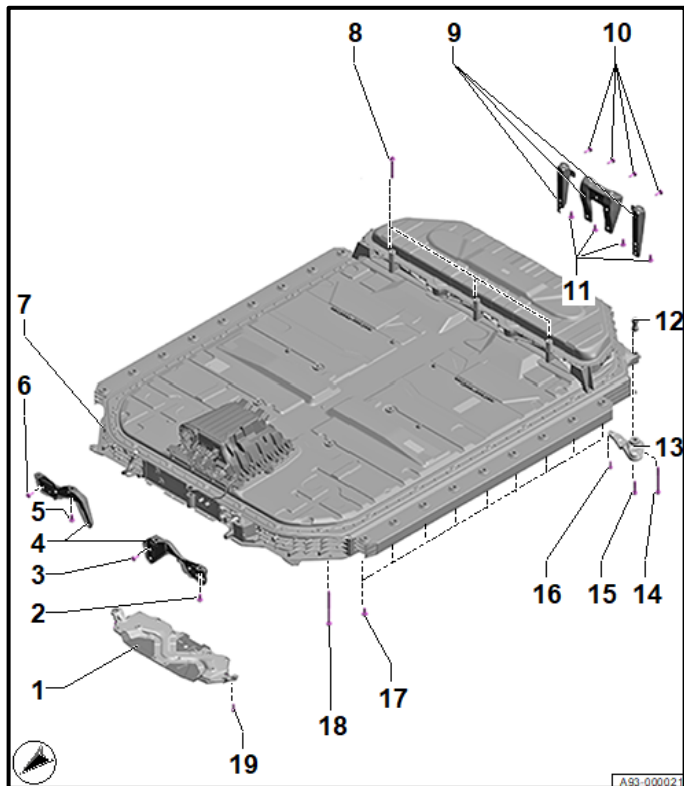

Vehicles assigned ONLY Criteria GE:

- Final remedy software update is not available.
- No action is needed at this time.

Vehicles assigned Criteria GE AND H* / J* and 01 or 02 or 03 and/or criteria M1-M9 and/or 10-36:

- Replace pre-determined cell modules.

NOTE

- These repair instructions may differ from the labor operations and labor times listed in ELSA.
- Damages resulting from improper repair or failure to follow these work instructions are the dealer's responsibility and are not eligible for reimbursement under this action.
- This procedure must be read in its entirety prior to performing the repair.
- Due to variations in vehicle equipment and options, the steps/illustrations in this work procedure may not identically match all affected vehicles.
- Diagnosis and repair of pre-existing conditions in the vehicle are not covered under this action.
- When working during extreme temperatures, it is recommended that the vehicle be allowed to acclimate inside the shop to avoid temperature-related component damage/breakage.

Required Tools (high-voltage battery evaluation)



Battery Tester/Charger
capable of **minimum 90
Amp** continuous supply















Diagnostic Tester
-VAS6150X/6160X-
(or equivalent)

Required Tools (if HV battery cell module requires replacement)

| | | | |
|---|---|--|---|
|  | <p>Washer N -901-797-04 (qty. 2)</p> |  | <p>Guide Pin -T10341-</p> |
|  | <p>Wedge Set -T10383- (or equivalent)</p> |  | <p>Holding Strap -T40155A- (qty. 2) (or equivalent)</p> |
|  | <p>Oil Sump Assembly Pin -T40199-</p> |  | <p>Seal Plug -T40417- (qty. 2)</p> |
|  | <p>Sealing Plug -T40418A- (qty. 3)</p> |  | <p>Cover -T40420-</p> |
|  | <p>Shock-Proof Protection (30 Pcs) -T40421-</p> |  | <p>Sealing Device -T40422-</p> |
|  | <p>Module Picker -T40424-</p> |  | <p>Adapter for diagnosis box HV battery -VAS5581/8-</p> |



| | | | |
|---|---|--|---|
|  | <p>Swivel Bolt M10 -VAS691015- (qty. 2)</p> |  | <p>Lifting Eye -VAS691013- (qty. 2)</p> |
|  | <p>Connection Cable -VAS6910/17-1-</p> |  | <p>Connection Cable -VAS6910/17-2-</p> |
|  | <p>Hose Clip Pliers -VAS6340- (or equivalent)</p> |  | <p>Leak Tester - Rubber Bungs -VAS6911/10- (qty. 8)</p> |
|  | <p>Leak Tester - Test Connector Set -VAS6911/3B-</p> |  | <p>Leak Tester - Seal Set -VAS6911/4- (qty. 2)</p> |
|  | <p>Warning Sign - High Voltage -VAS6649-</p> |  | <p>Warning Sign - "Do Not Switch On" -VAS6650A-</p> |
|  | <p>Warning Sign - Battery -VAS6786-</p> |  | <p>Warning Sign - "Do Not Insert" -VAS6871-</p> |

| | |
|---|--|
|  <p>Scraper Set -VAS6845- -or- -VAS895015-</p> |  <p>High-voltage tool set -VAS6762A- (or -VAS6762-)</p> |
|  <p>Plastic Wedge Set -VAS852015-</p> |  <p>Pneumatic Applicator - Cartridge Gun -VAS891005-</p> |
|  <p>Scissor Lift Table -VAS6131B- (or equivalent)</p> |  <p>Engine Bung Set -VAS6122- (or equivalent)</p> |
|  <p>Digital Pressure Sensor -VAG1397B-</p> |  <p>Shop Crane -VAS6100- (or equivalent)</p> |
|  <p>Cooling System Tester - Directional Valve -VAS691005/1- (component of -VAS691005-)</p> |  <p>High Voltage Tool Set - Torque Wrench -VAS6883/1A-</p> |
|  <p>High Voltage Tool Set - Voltage Tester -VAS6762/45- (component of - VAS6762A-)</p> |  <p>Cooling System Tester - Directional Valve -VAS691005/5- (component of -VAS691005-)</p> |

| | | | |
|---|--|--|--|
|  | <p>Module Balancer -VAS6910- Or -VAS6910A-</p> |  | <p>Cooling System Service Machine – TEXA -VAS531011KIT-</p> |
|  | <p>Cooling System Tester -VAG1274B-</p> |  | <p>Hose Clamps - Up To 25mm -3094- (or equivalent)</p> |
|  | <p>Padlock -T40262/1- (from Service Disconnect Lock -T40262-)</p> |  | <p>Vehicle Diagnosis System - Connection Lead -VAS5051/66-</p> |
|  | <p>Pressure Sensor -VAS611013-</p> |  | <p>Insulated Torx Wrench Set - 3/8 -VAS691003A-</p> |
|  | <p>Test Adapter - Hybrid Module -VAS6558A-</p> |  | <p>*High Voltage Diagnostics Box -VAS5581A-</p> |
|  | <p>Battery Tester/Charger capable of minimum 90 Amp continuous supply</p> |  | <p>Shackle (Equivalent to VAS691009A) -VAS691009US- Qty. = 5</p> |

| | | | |
|---|---|--|---|
|  | <p>Diagnostic Tester -VAS6150X/6160X- (or equivalent)</p> |  | <p>Set of Kelvin Clamps and Test Probes -VAS6558A/27-</p> |
|  | <p>Removal Tool -T40445- (or equivalent)</p> |  | <p>Spatula kit -VAS281011- (or equivalent)</p> |
|  | <p>Insulating Mat -VAS6762/44- Qty. = 2</p> | | |

Required Shop Materials (if necessary)

| | | | |
|---|---|--|---|
|  | <p>Cleaner D -009-401-04 (shop supply) -OR- 91% Isopropyl Alcohol (locally sourced)</p> |  | <p>Lint Free Towels (locally sourced)</p> |
| <p><i>NOTE: Use only 91% Isopropyl alcohol as a cleaner (9% water). Do not use Isopropyl with any additional surfactants (cleaners) or additives (scents).</i></p> | | | |

Repair Instruction

Section A - Check for Previous Repair

| Applicable criteria ID(s) | Campaign/Action Status |
|---------------------------|------------------------|
| 01 ← 2 | Open ← 1 |

EXAMPLE

| Campaign/Action | Start | Designation |
|-----------------|------------|--------------|
| → 3 | 2015-11-10 | W-SERV_ACT - |
| | 2018-12-13 | RECALL - |
| | 2017-05-16 | A-RECALL - |

EXAMPLE

- Enter the VIN in Elsa and proceed to the “Campaign/Action” screen.

TIP

On the date of repair, print this screen and keep a copy with the repair order.

- Confirm the Campaign/Action is open <arrow 1>. If the status is closed, no further work is required.
- Note the Applicable Criteria ID <arrow 2> for use in determining the correct work to be done and corresponding parts associated.

CRITICAL REPAIR STEP



If multiple software update Campaign/Actions are open, they must be performed in order of the Start date <arrow 3>. The oldest should be performed first.

- **All Safety Recalls must be completed prior to completing this campaign.**

Vehicles assigned ONLY Criteria GE:

- Final remedy software update is not available.
- No action is needed at this time.
- **NO WORK WILL BE PERFORMED OR CLAIMED.**

Vehicles assigned Criteria GE AND H* / J* AND 01 or 02 or 03 AND/OR Criteria M1-M19 and/or 10-36:

- Proceed to Section B.

Section B – Evaluating Module Replacement Requirements

! IMPORTANT



Vehicles assigned criteria M1-M10 and/or 11-36 **WITHOUT** criteria J* and/or H*:

- **NO TAC CASE IS REQUIRED TO EVALUATE THE MODULE POSITION REQUIRING REPLACEMENT.**
- These criteria determine the position of the module requiring replacement.
- Proceed to Section C for cell module replacement.

! IMPORTANT



Vehicles assigned criteria J* and/or H* (including vehicles also assigned criteria M1-M9 and/or 10-36):

Analysis of the high-voltage battery is required to determine the following:

- Which position of the pre-determined cell module is to be replaced.
- If additional cell modules also require replacement.
- The analysis is carried out by factory representatives, located in Germany. Once the TAC case is created using the directions below, the data will be analyzed and a response will be provided within 24 hours (in most cases).

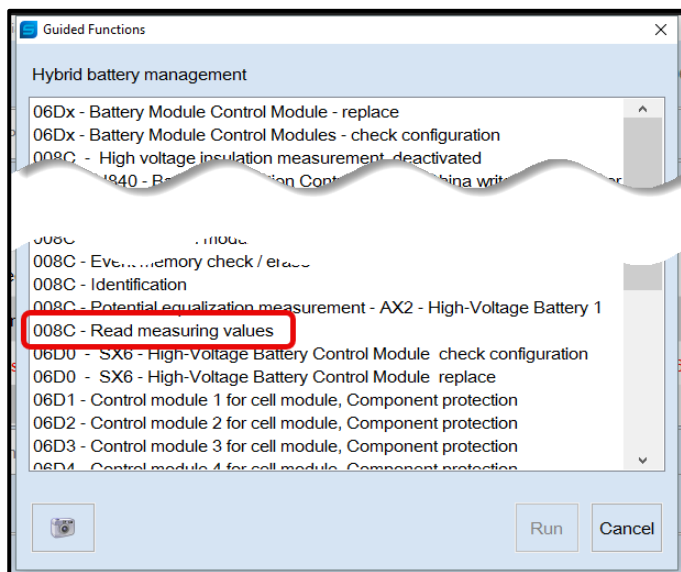

- Connect battery maintainer.
- Perform a full diagnostic scan of the vehicle.
- Select and perform the Guided Function test plan “008C – Read measuring values” for diagnostic address 008C.

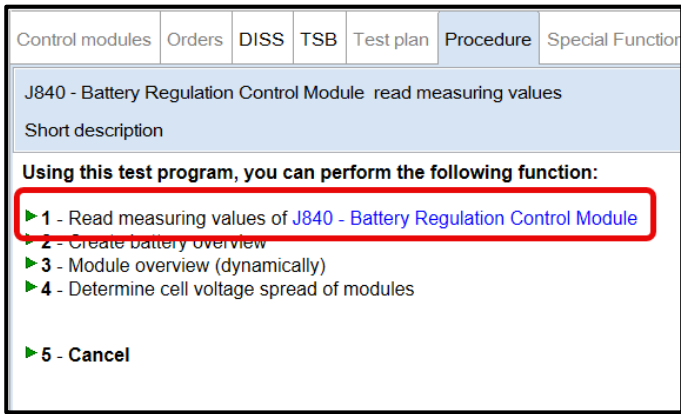

- Select the option “Read measuring values of J840 – Battery Regulation Control Module.”

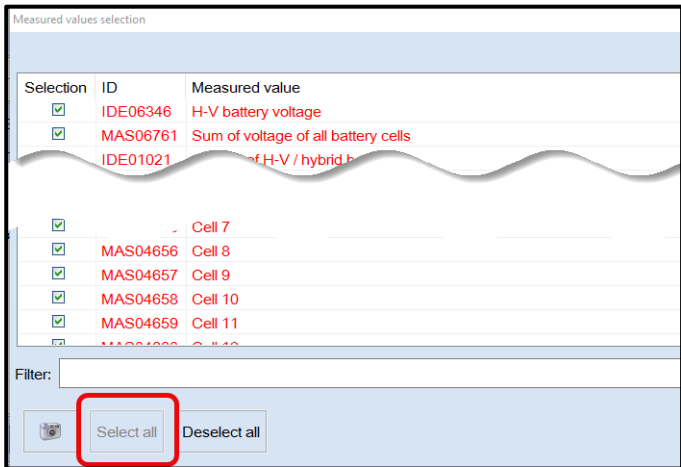

- Select all MVB's, then select OK.

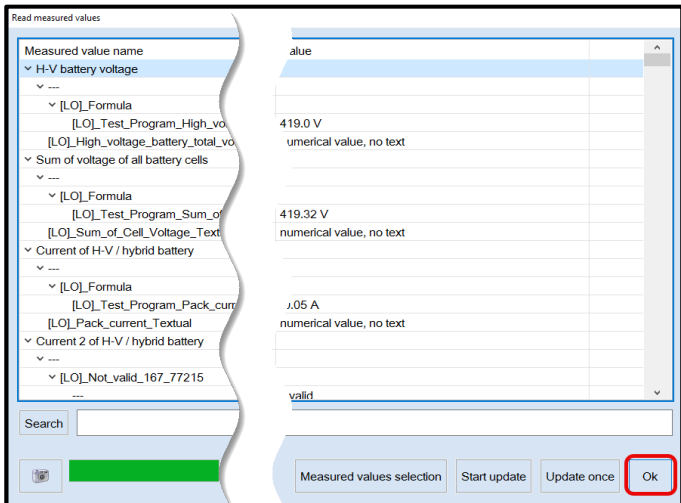

- When all MVB's are displayed, select OK.
- Follow the on screen prompts until test plan is completed.
- Exit GFF.
- Ensure the diagnostic log is sent to GFF Paperless.

22 items found, displaying all.

| Sr.No | VIN | Diagnosis ID | Diagnosis Date | Transfer Date | Importer/Dealer | DTE (TU) | DTC | Tester ID | Repair Order | Log Status | Log Type |
|-------|-----|--------------|---------------------|---------------------|-----------------|----------|---------|----------------------------------|--------------|------------|----------------------|
| 1 | | 182560188 | 2023-07-19 00:00:00 | 2023-07-19 11:37:50 | | 30 | B153813 | 7afd411f4a98ef92cebed61b5aa51ece | --- | Final | Guided Fault Finding |
| 2 | | 179616477 | 2023-02-02 00:00:00 | 2023-02-02 06:06:39 | | 17 | B153813 | 35ae23eb73cc47a4270f45fca1366550 | --- | Temporary | Guided Fault Finding |

- Record the Diagnosis ID of the log from GFF Paperless.

Technical Assistance

Create Ticket

Ticket Information

Concern Type: 93V2/93U9 HV Battery Evaluation – Web Ticket Only Technician Email:

Technician Name: Dealer Code: 000000

Vehicle Information

VIN: Make: A

Model: 8K256H Model Year: 2011

Mileage: Engine Code: CAEB

Contact Options: I will call now I will wait for web response (up to 2 business hours) Transmission Code: MVC

Technician Questionnaire

Attachments

GFF Diagnosis ID:

Enter required worksheet information: Select a worksheet to download

Attachment Type: File1: No file chosen

- Create a TAC Web Ticket as follows:
 - Select the correct concern group:
 - US DEALERS** - “93V2/93U9 HV Battery Evaluation – Web Ticket Only” as the concern group
 - CANADIAN DEALERS** - “93V2/93U9 HV Battery Evaluation”
 - Enter your preferred e-mail address.
 - Select “I will wait for a web response.”
 - Enter the GFF Diagnosis ID from the log uploaded to GFF Paperless.

- The response back from Germany may take up to 24 hours.
- During this time, the vehicle cannot be released to the customer.
- Germany will provide the position of the cell module(s) to be replaced. After this direction is received:
 - The vehicle cannot be released to the customer until the affected module(s) has been replaced.
 - Proceed to Section C once all parts and tools are available to complete the repair.

! IMPORTANT

The TAC case for analyzing the battery cannot be used for any other direction. If additional TAC assistance is needed (technical direction, cell balancer loaner program, etc.), a separate TAC case will need to be created.

Section C – Replacing Cell Module(s)

CRITICAL REPAIR STEP

 **STOP!** 

Before balancing the new cell module, be sure that the vehicle is ready for the repair to be performed.

If possible, the high voltage battery should be de-energized right after recording the voltage reading to avoid possible voltage variations.

Charging the vehicle, driving the vehicle, leaving the ignition on, or running the HVAC can change the high voltage battery voltage.

After reading out the maximum cell module voltage from the MVBs, avoid moving the vehicle if possible. The vehicle must not be charged or have any electrical consumers used. If this step is not followed, there is a risk that the new cell module will not be balanced correctly resulting in possible faults and having to remove and re-balance the cell module again.

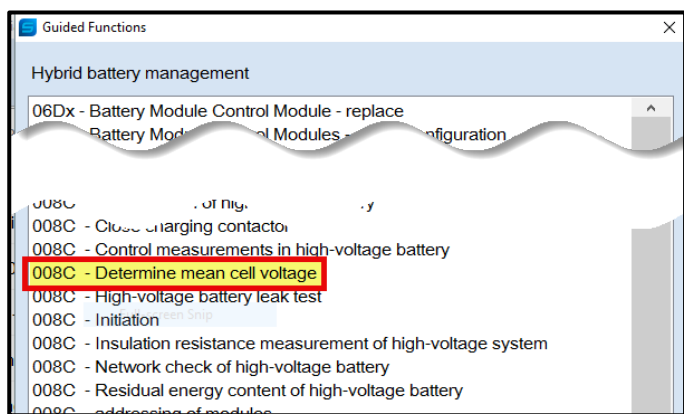

Perform cell balancing on new cell module(s):

- Perform the Guided Function test plan, “008C – Determine mean cell voltage” and record the mean voltage value.



- When charging or discharging a new cell module, follow the instructions in the ELSA repair manual in conjunction with the operating instructions for the cell balancer being used

TIP

Operating instructions for the VAS6910, VAS6910A, and DSS Manager program can be found on the Audi Special Tools and Equipment website.

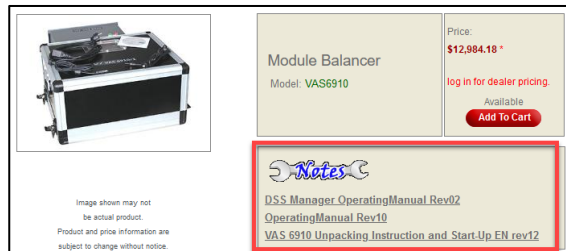

Image shown may not be actual product. Product and price information are subject to change without notice.

Module Balancer
Model: VAS6910
Price: \$12,984.18*
log in for dealer pricing.
Available
Add To Cart

Notes
DSS Manager OperatingManual Rev02
OperatingManual Rev10
VAS 6910 Unpacking Instruction and Start-Up EN rev12

| Tests in current test plan | |
|----------------------------|--|
| Status | Tests (sorted according to chances of success) |
| > | J533 - Sequence error during operating mode setting - high voltage |
| > | J1050 - External charging infrastructure |
| | 0001 - Check warranty info |
| | 008C - Classification of high-voltage battery |
| | 008C - Classification of a battery module |
| | 008C - Initiation |
| | Establish high-voltage de-energization |
| | High-voltage re-energization |

Populate Guided Function test plans:

- Perform a diagnostic scan of the vehicle.
- Select “Self Test” and populate the following test plans:
 - 008C - Classification of high-voltage battery
 - 008C - Classification of a battery module
 - 008C - Initiation
 - Establish high-voltage de-energization
 - High-voltage re-energization

| Tests in current test plan | |
|----------------------------|--|
| Status | Tests (sorted according to chances of success) |
| > | J533 - Sequence error during operating mode setting - high voltage |
| > | J1050 - External charging infrastructure |
| | 0001 - Check warranty info |
| | 008C - Classification of high-voltage battery |
| | 008C - Classification of a battery module |
| | 008C - Initiation |
| | Establish high-voltage de-energization |
| | High-voltage re-energization |

De-energize the high-voltage system:

⚠ DANGER

There is a risk of fatal injury due to high voltage. Electrocutation by direct contact or electric arc can cause severe bodily injury or fatal injury.
Have a high-voltage technician or a high-voltage expert de-energize the high-voltage system.

- Reference the ELSA Repair Manual:
 - *Repair manual > Motor > Electric Drive Motor 0EF > 93 Electric drive > High-Voltage System, De-Energizing.*
- Perform these steps in conjunction with the test plan “Establish high-voltage de-energization”.

| Tests in current test plan | |
|----------------------------|--|
| Status | Tests (sorted according to chances of success) |
| > | J533 - Sequence error during operating mode setting - high voltage |
| > | J1050 - External charging infrastructure |
| | 0001 - Check warranty info |
| | 008C - Classification of high-voltage battery |
| | 008C - Classification of a battery module |
| | 008C - Initiation |
| | Establish high-voltage de-energization |
| | High-voltage re-energization |

High-voltage battery classification:

- Reference the ELSA Repair Manual:
 - *Repair manual > Motor > Electric Drive Motor 0EF > 93 Electric drive > High-Voltage Battery Unit > High-Voltage Battery 1 AX2, Visual Inspection and Classification.*
- Perform these steps in conjunction with the test plan “008C – Classification of high-voltage battery”.

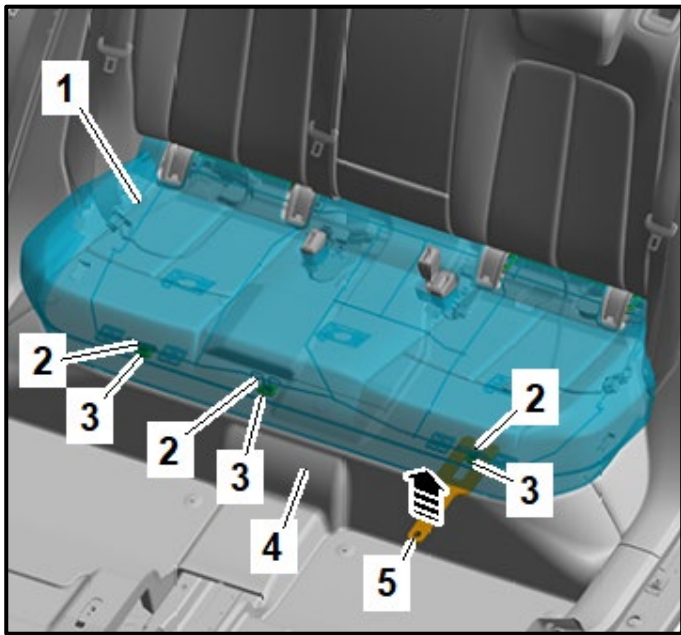

Remove the rear bench seat:

- Remove the rear bench seat <1> per the ELSA Repair Manual:
 - *Repair manual > Body > Body Interior > 72 Seat Frames > Rear Seats > Bench Seat/Single Seat, Removing and Installing.*

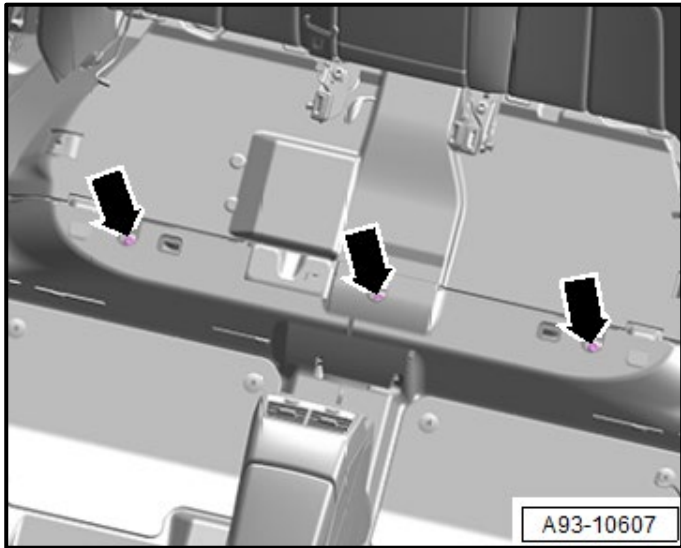

- Remove the bolts <arrows>.

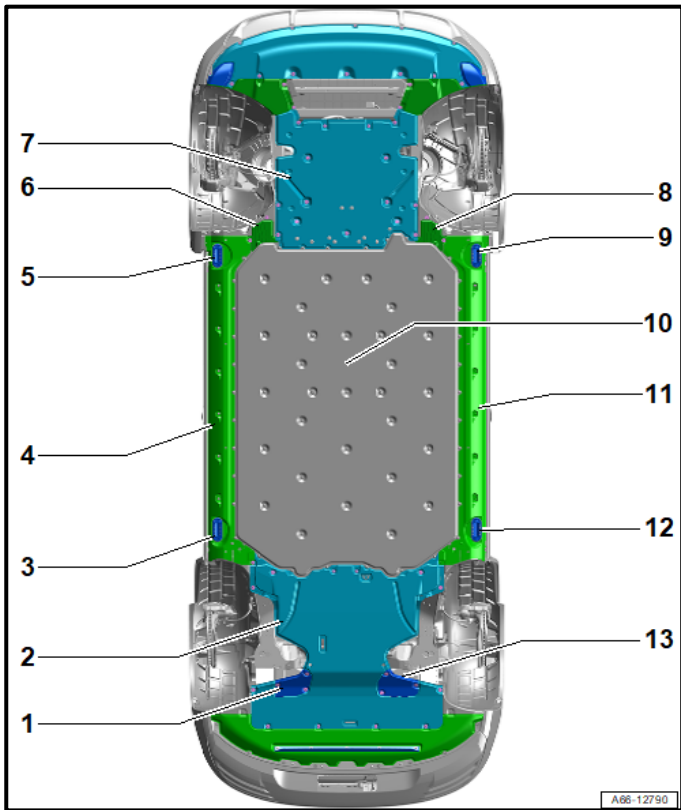

Remove front and rear underbody trim panels:

- Remove the following underbody trim panels:
 - Front trim panels <6>, <7>, and <8>.
 - Rear trim panels <1>, <2>, and <13>.

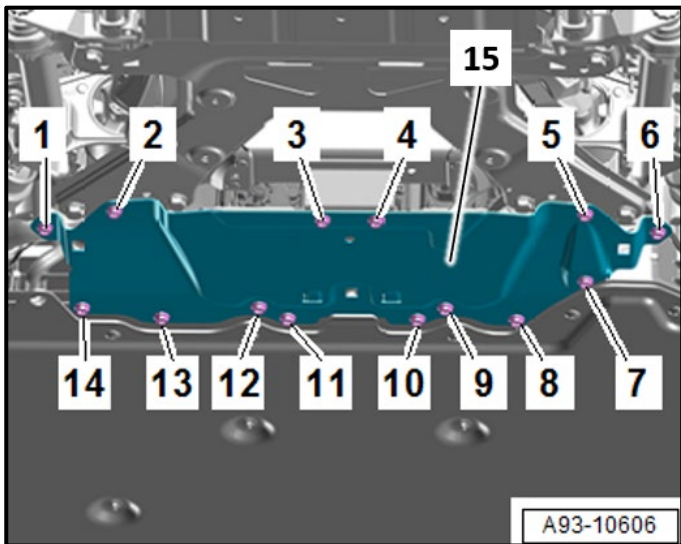

Remove the impact guard:

- Remove the impact guard <15> per the ELSA Repair Manual:
 - *Repair manual > Chassis > Suspension, Wheels, Steering > 40 Front Suspension > Subframe > Impact Guard, Removing and Installing.*

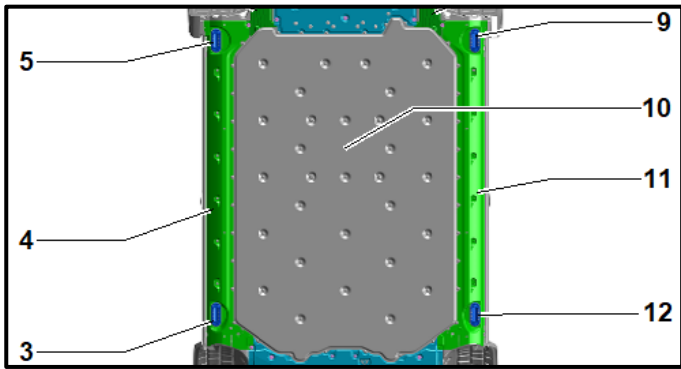

Remove left and right underbody trim panels:

- Lower the vehicle so that the hoist arms are no longer contacting the vehicle.
- Remove the left and right side trim panels <4> and <11>.
- Lift the vehicle again.

NOTE

Removal of the high-voltage battery is not possible on all hoists. Prior to removal, verify that there is sufficient clearance between the lift arms and the high-voltage battery frame so that it can be lowered without interference.

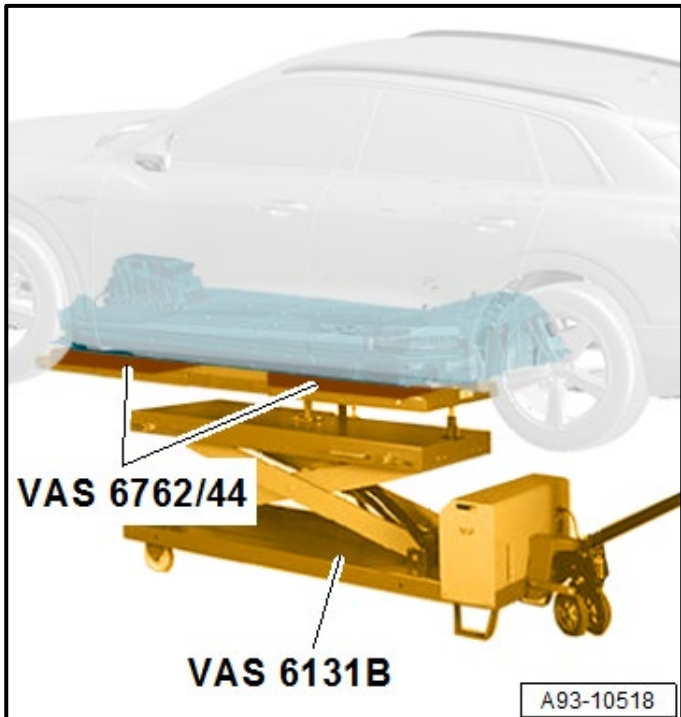

Remove the high-voltage battery:

- Remove the high-voltage battery per the ELSA Repair Manual:
 - *Repair manual > Motor > Electric Drive Motor 0EF > 93 Electric drive > High-Voltage Battery Unit > High-Voltage Battery 1 AX2, Removing and Installing.*
- Note the following when removing the high-voltage battery:
 - Mark the position of the scissor lift table on the floor to aid in repositioning the table during reinstallation.
 - Pay close attention to all wiring harnesses when lowering the battery.
 - Pay close attention to all coolant hoses when lowering the battery.

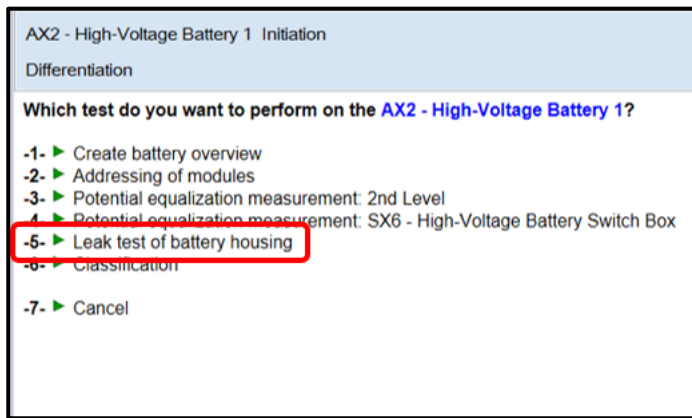

Perform high-voltage battery leak test:

- Perform the steps below in conjunction with test plan, “008C - Initiation > select option: Leak test of battery housing.”
- Perform a leak test of the high-voltage battery per the ELSA Repair Manual:
 - *Repair manual > Motor > Electric Drive Motor 0EF > 93 Electric drive > High-Voltage Battery Unit > High-Voltage Battery 1 AX2 Leak Test > Testing Tools, Cleaning and Checking.*
 - *Repair manual > Motor > Electric Drive Motor 0EF > 93 Electric drive > High-Voltage Battery Unit > High-Voltage Battery 1 AX2 Leak Test > Preparing for Calibration - High-Voltage Battery Leak Test, Part 1, 95 kWh / 115 kWh.*
 - *Repair manual > Motor > Electric Drive Motor 0EF > 93 Electric drive > High-Voltage Battery Unit > High-Voltage Battery 1 AX2 Leak Test > Preparing for Calibration - High-Voltage Battery Leak Test, 71 kWh, 95 kWh, 115 kWh Part 2.*
 - *Repair manual > Motor > Electric Drive Motor 0EF > 93 Electric drive > High-Voltage Battery Unit > High-Voltage Battery 1 AX2 Leak Test > Battery Housing Layer 2 Leak Test, 95 kWh / 115 kWh.*

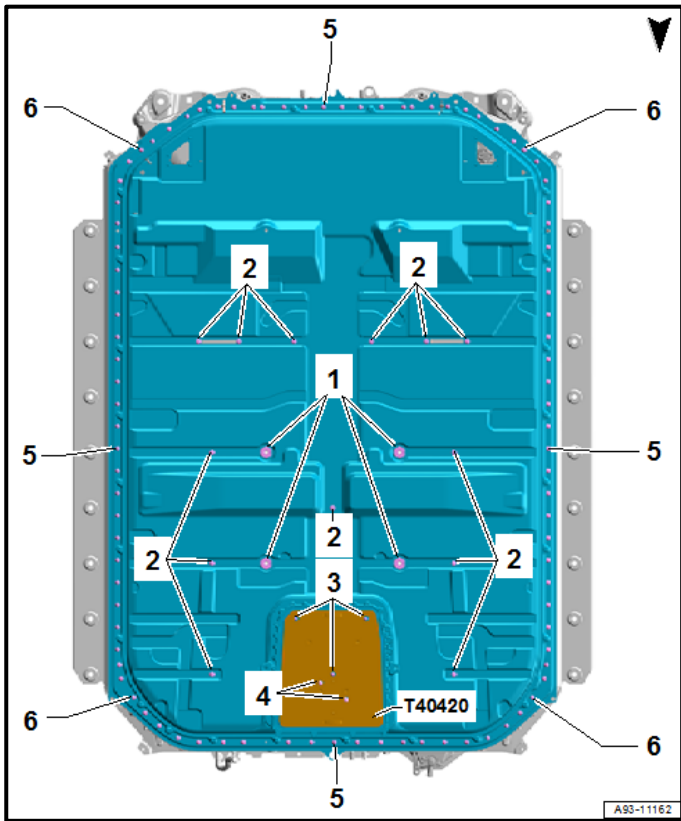

Remove the high voltage battery cover:

⚠ DANGER

There is a risk of fatal injury due to high voltage. Severe bodily injury or death by electrocution or electric arcs is possible.

The following procedures may only be performed by a qualified high-voltage expert HVE.

⚠ DANGER

There is a risk of fatal injury due to high voltage. Electrocution by direct contact or electric arc can cause severe bodily injury or fatal injury.

- For the following procedures suitable personal protective equipment must be worn.
- For the following steps two correspondingly qualified technicians must be present for the supervision.
- If necessary, a second technician can help the high-voltage expert outside of the hazardous area within their qualification.
- The personal protective equipment (PPE) must be dry and undamaged.

⚠ CRITICAL REPAIR STEP



RISK OF SEVERE CONSEQUENTIAL DAMAGE!

USE HAND TOOLS ONLY!

Do not use power tools to remove any of the bolts. Using power tools to remove the bolts can damage the threads in the lower housing. If the threads of the interior bolts <1>, <2>, <3>, and <4> are damaged, the lower housing will require replacement.

Claims for lower housing replacements due to improper bolt removal will be denied.

- Clean off any debris that has accumulated on the battery housing prior to opening.

⚠ CAUTION

Risk of damaging the high-voltage battery components due to incorrect handling.

Pay close attention to the ELSA repair manual cautions.

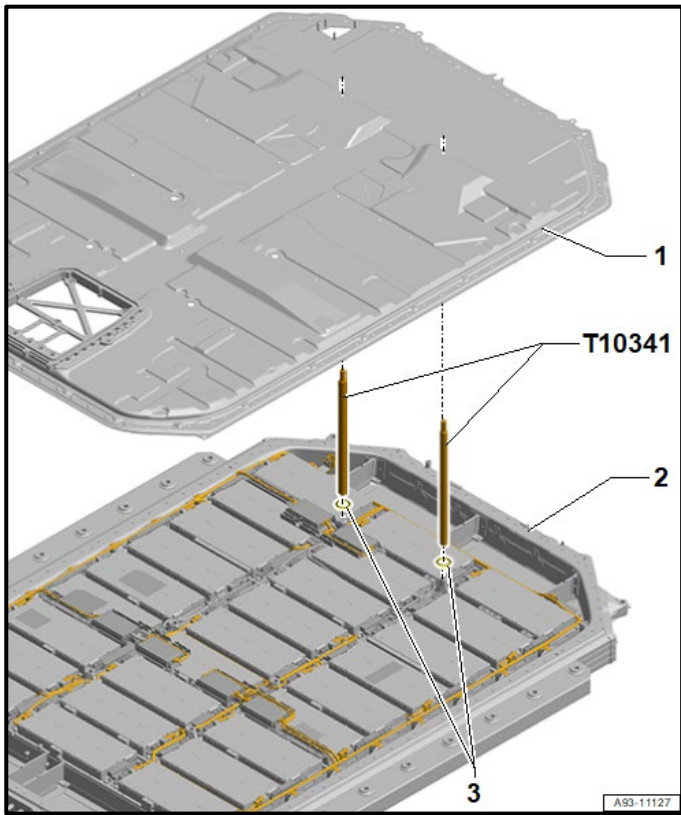

- Refer to the ELSA Repair Manual for high-voltage battery cover removal:
 - **Layer 1 module replacement:**
Repair manual > Motor > Electric Drive Motor 0EF > 93 Electric drive > High-Voltage Battery Components > Battery Housing Cover, Removing and Installing > Cover for Battery Housing Layer 1, Removing and Installing, 95 kWh / 115 kWh.
 - **Layer 2 module replacement:**
Repair manual > Motor > Electric Drive Motor 0EF > 93 Electric drive > High-Voltage Battery Components > Battery Housing Cover, Removing and Installing > Cover for Battery Housing Layer 2, Removing and Installing, 95 kWh / 115 kWh.

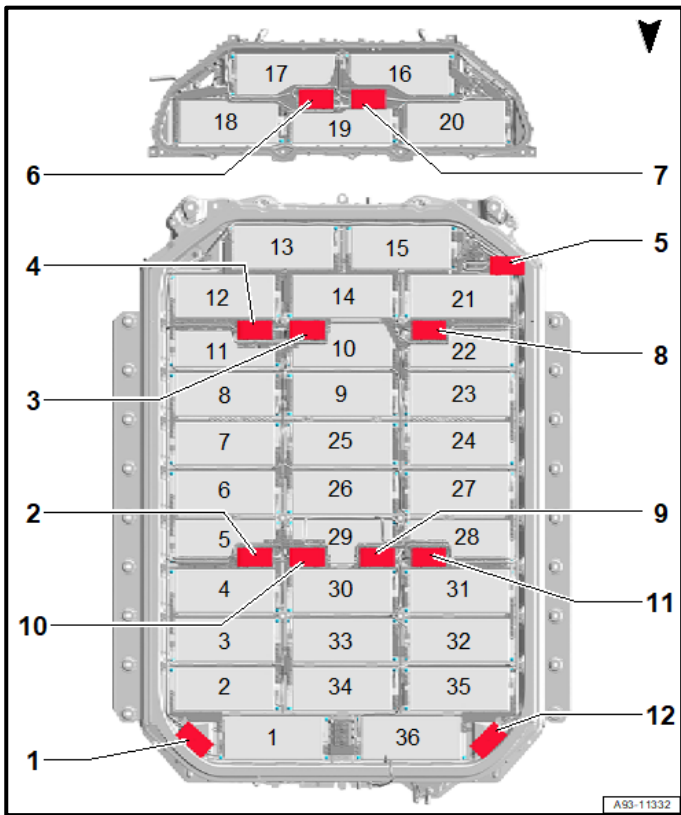

Identify the cell module that requires replacement:

- Locate and clearly mark the cell modules that are going to be replaced per the ELSA Repair Manual:
 - *Repair manual > Motor > Electric Drive Motor 0EF > 93 Electric drive > High-Voltage Battery Components > Battery Modules, Battery Connector and Control Modules, Marking.*

⚠ IMPORTANT

The level/layer (1 and/or 2) in which the module is replaced must be recorded on the repair order. This allows for proper claiming of the repair.

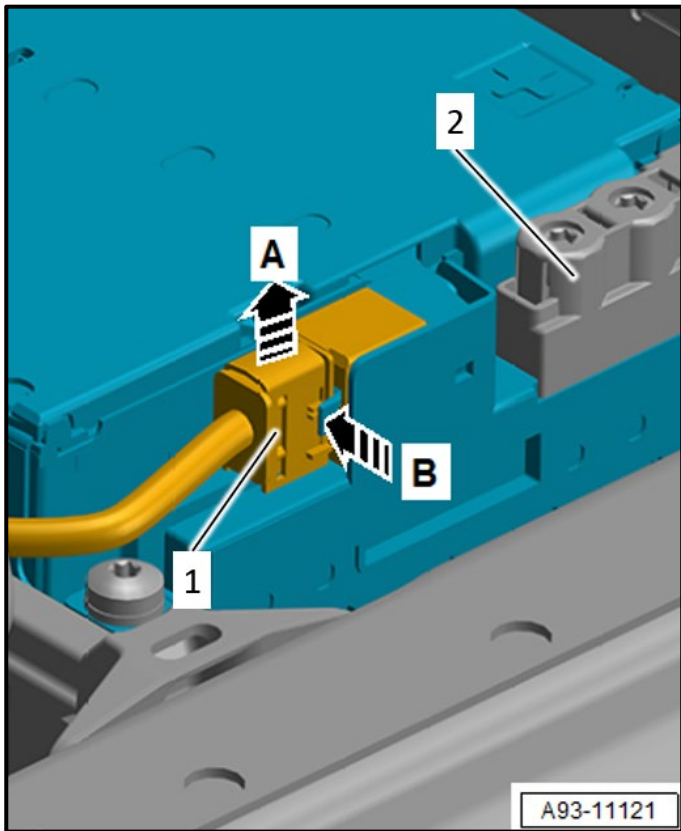

Remove the affected cell module(s):

⚠ CRITICAL REPAIR STEP



RISK OF CONSEQUENTIAL DAMAGE!

- Pay close attention to the repair manual steps.
- The 32-pin connector <1> must be removed before removing the high-voltage connection <2>. Failure to do so can result in damage to the battery module control module.
- Claims for replacement of the battery module control module due to improper cell module disconnection will be denied.

⚠ WARNING

There is a risk of injury by using the incorrect tools!

Never use a workshop crane to remove the battery module from the thermal compound.

⚠ CAUTION

Grease or dirt at the contact surfaces increases the contact resistance. It can overheat when the battery is put into operation. Risk of fire!

- Only touch the contact surfaces of the battery connectors and terminals of the battery modules when wearing gloves.
- Immediately clean dirty contact surfaces using isopropyl alcohol.

- Refer to the ELSA Repair Manual for cell module removal:

- *Repair manual > Motor > Electric Drive Motor 0EF > 93 Electric drive > High-Voltage Battery Components > Battery Module, Removing.*

- Ensure the shock protection is installed on ALL open high-voltage connections.



Clean the mounting area for the new cell module:

⚠ CAUTION

Contamination of the adhesive surface is possible due to the thermal compound containing silicone.

Avoid contact with adhesive surfaces.

- Ensure that the old thermal compound is removed from the battery housing per the instructions outlined in the cell module removal section.
- Vacuum any shavings/debris from the module threaded connections.
- Do not allow the cleaner to come into contact with any of the lower housing frame sealant.

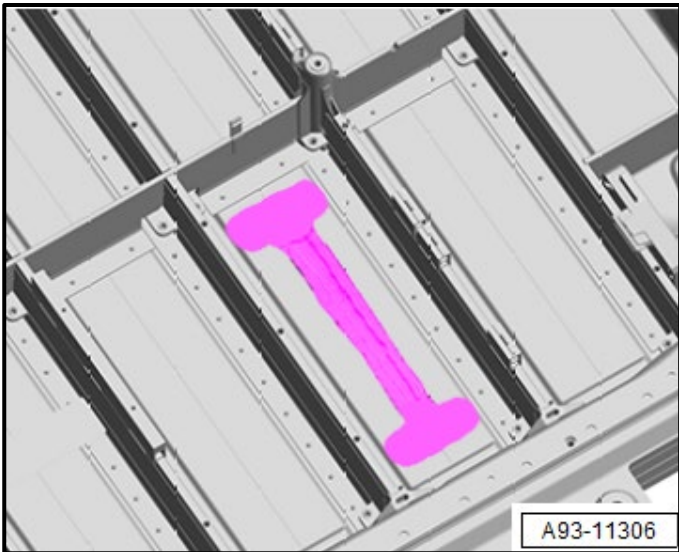

Installing new cell module(s):

- Refer to the ELSA Repair Manual for cell module installation:
 - *Repair manual > Motor > Electric Drive Motor 0EF > 93 Electric drive > High-Voltage Battery Components > Battery Module, Installing.*
- Note the following when installing a new cell module:
 - Double check the expiration date of the heat paste before applying.
 - Before applying the heat paste to the battery housing, release a small amount through the applicator on a piece of paper to ensure the paste is mixing properly.
 - Apply the specified amount of two-part thermal compound into the battery housing per the repair manual instructions.

| Part Number | Part Description |
|---------------|--|
| D -G00-020-M2 | Heat Paste (qty. 1 per cell module) |

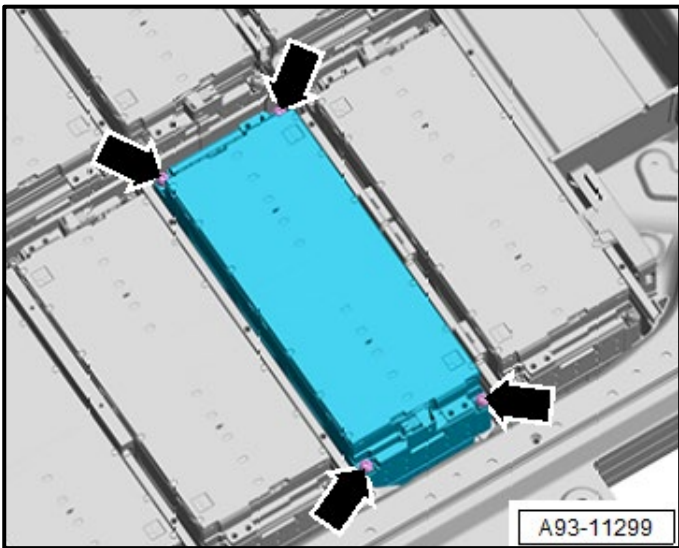

- Tighten new bolts <arrows> per the ELSA Repair Manual:
 - *Repair manual > Motor > Electric Drive Motor 0EF > 93 Electric drive > High-Voltage Battery Components > Component Location Overview - Battery Modules > Component Location Overview - Battery Modules, 95 kWh / 115 kWh.*

| Part Number | Part Description |
|-------------|---|
| WHT-009-516 | Bolt with washer (qty. 4 per cell module) |

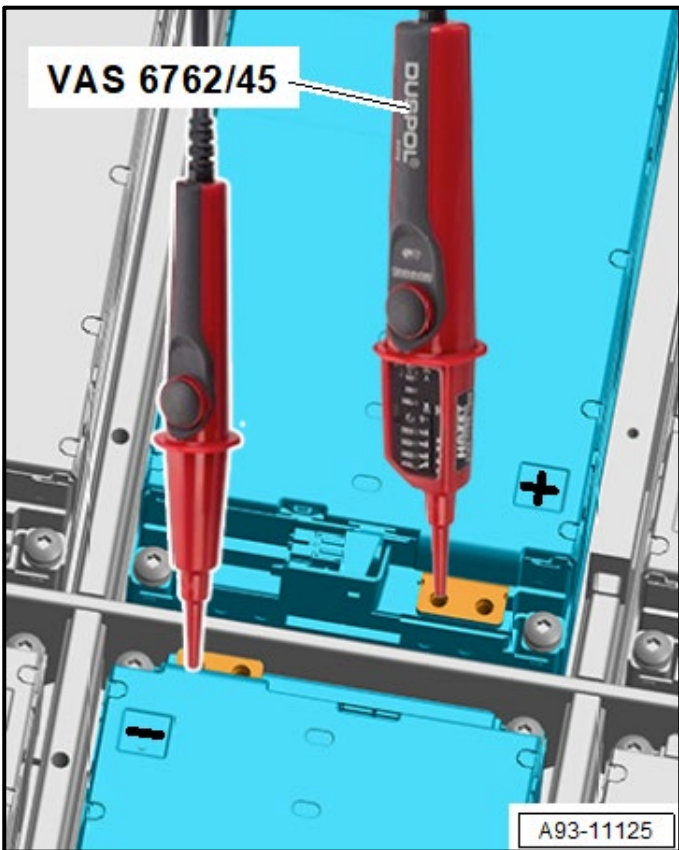

⚠ DANGER

Incorrect installation of battery modules and module connectors.
Short circuit electric arc can cause severe bodily or fatal injuries.

- Check the battery modules and module connectors for correct installation.
- Only continue with the procedure when there is no voltage in between the battery terminals.
- Pay very close attention to the Repair Manual steps outlining the use of the -VAS6762/45-.

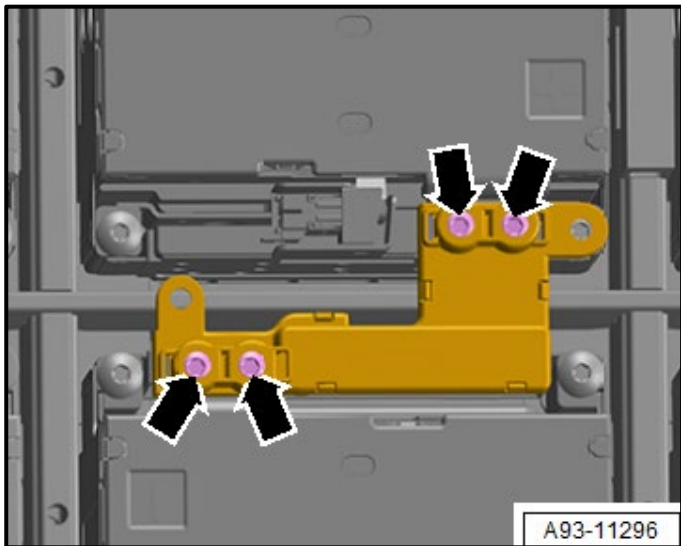

- If the voltage measurement is ok, install the battery connector immediately.
- Tighten the bolts <arrows> per the ELSA Repair Manual:
 - *Repair manual > Motor > Electric Drive Motor 0EF > 93 Electric drive > High-Voltage Battery Components > Component Location Overview - Battery Connector > Component Location Overview - Battery Connectors, 95 kWh / 115 kWh.*
- Continue with reassembly.

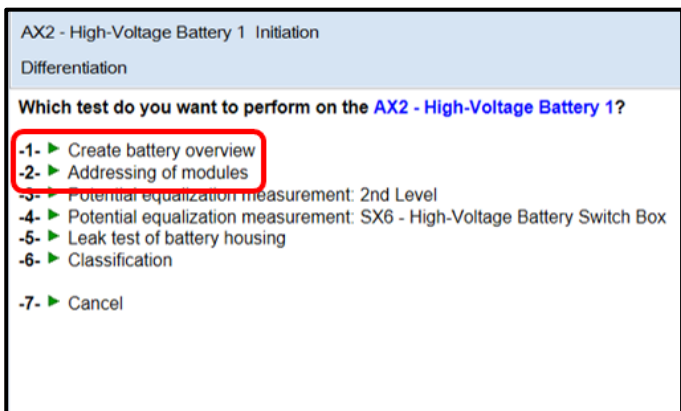

High-voltage battery preliminary operation:

⚠ DANGER

There is a risk of fatal injury due to high voltage. Severe bodily injury or death by electrocution or electric arcs is possible.

Pay very close attention to the Repair Manual steps.

- Perform the steps below in conjunction with following Guided Function test plans:
 - “008C – Initiation > -1- Create battery overview”.
 - “008C – Initiation > -2- Addressing of modules”.
- Refer to the ELSA Repair Manual for high-voltage battery preliminary operation:
 - *Repair manual > Motor > Electric Drive Motor 0EF > 93 Electric drive > High-Voltage Battery Components > High-Voltage Battery Preliminary Operation > High-Voltage Battery Preliminary Operation, Preparing for Calibration - 95 kWh / 115 kWh*
 - *Repair manual > Motor > Electric Drive Motor 0EF > 93 Electric drive > High-Voltage Battery Components > High-Voltage Battery Preliminary Operation > High-Voltage Battery Preliminary Operation - 95 kWh / 115 kWh.*

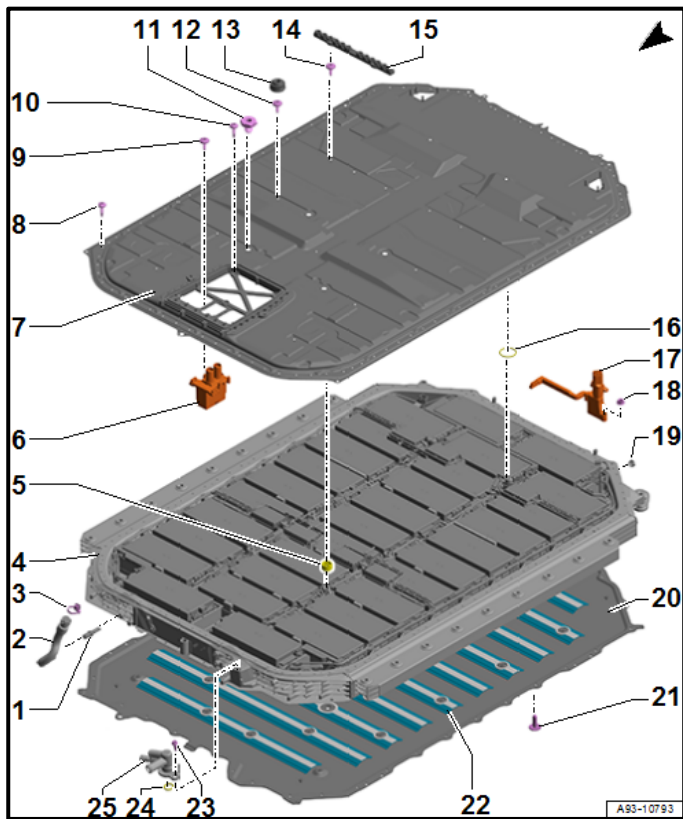

Install the high-voltage battery cover(s):

- Refer to the ELSA Repair Manual for battery cover installation:
- **Layer 1 battery cover installation:**
 - *Repair manual > Motor > Electric Drive Motor 0EF > 93 Electric drive > High-Voltage Battery Components > Battery Housing Cover, Removing and Installing > Cover for Battery Housing Layer 1, Removing and Installing, 95 kWh / 115 kWh.*
- Torque all the high-voltage battery cover bolts per the ELSA Repair Manual:
 - *Repair manual > Motor > Electric Drive Motor 0EF > 93 Electric drive > High-Voltage Battery Components > Overview - Removed High-Voltage Battery > Overview - Removed High-Voltage Battery, 95 kWh / 115 kWh.*
- Use new hardware when specified by the repair manual.

| Part Number | Part Description |
|---------------|---------------------------------------|
| WHT-008-659 | Perimeter bolt (qty. 95) |
| WHT-008-738 A | Center bolts (qty. 13) |
| N -101-961-07 | Bolt (qty. 18) |
| N -906-132-01 | O-ring (qty. 2) |
| D -450-P00-M2 | Butyl sealing cord (qty. 2) |
| 4KE-801-332 | Damper (qty. 4) |
| 4KE-801-557 | Banjo bolt (qty. 4) |
| 4KE-805-696 | Damper (qty. 2) |
| 4KE-915-433 | Seal (version with SX6 seal insert) |
| G -052-567-A2 | Grease (version with SX6 seal insert) |

NOTE

Before layer 2 is installed, a leak test is required. See the leak test instructions for layer 1 below.

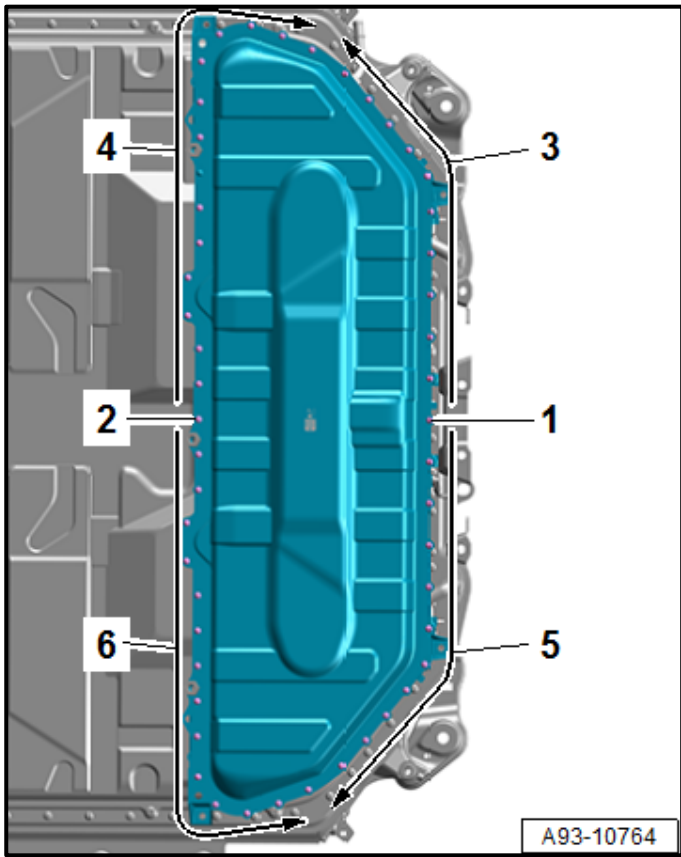

- **Layer 2 battery cover installation:**

- *Repair manual > Motor > Electric Drive Motor 0EF > 93 Electric drive > High-Voltage Battery Components > Battery Housing Cover, Removing and Installing > Cover for Battery Housing Layer 2, Removing and Installing, 95 kWh / 115 kWh.*
- Torque all the high-voltage battery cover bolts per the ELSA Repair Manual:
 - *Repair manual > Motor > Electric Drive Motor 0EF > 93 Electric drive > High-Voltage Battery Components > Overview - Removed High-Voltage Battery > Overview - Removed High-Voltage Battery, 95 kWh / 115 kWh.*
- Use new hardware when specified by the repair manual.

| Part Number | Part Description |
|---------------|-----------------------------|
| 4KE-915-434 | Seal (qty. 2) |
| N -106-847-01 | Perimeter bolts (qty. 50) |
| D -450-P00-M2 | Butyl sealing cord (qty. 1) |

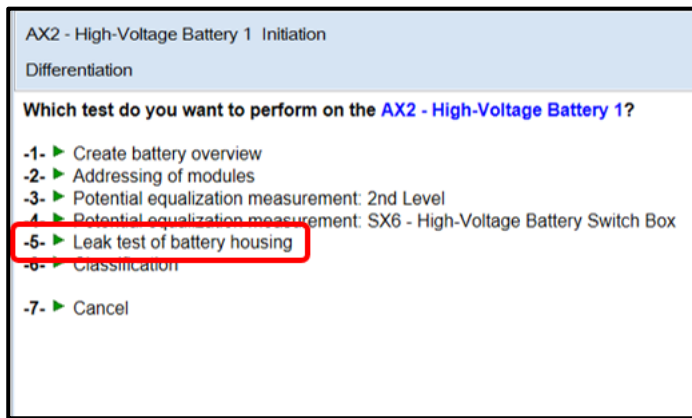

Perform high-voltage battery leak test:

- Perform the steps below in conjunction with the test plan, “008C – Initiation > select option: Leak test of battery housing.”
- Perform a leak test of the high-voltage battery per the ELSA Repair Manual:

| Part Number | Part Description |
|---------------|-------------------------------|
| 12E-915-754 | Pressure relief valve (qty.8) |
| G -052-567-A2 | Grease |

- **Leak test preparation:**

- *Repair manual > Motor > Electric Drive Motor 0EF > 93 Electric drive > High-Voltage Battery Unit > High-Voltage Battery 1 AX2 Leak Test > Testing Tools, Cleaning and Checking.*
- *Repair manual > Motor > Electric Drive Motor 0EF > 93 Electric drive > High-Voltage Battery Unit > High-Voltage Battery 1 AX2 Leak Test > Preparing for Calibration - High-Voltage Battery Leak Test, Part 1, 95 kWh / 115 kWh.*
- *Repair manual > Motor > Electric Drive Motor 0EF > 93 Electric drive > High-Voltage Battery Unit > High-Voltage Battery 1 AX2 Leak Test > Preparing for Calibration - High-Voltage Battery Leak Test, 71 kWh, 95 kWh, 115 kWh Part 2.*

- **Layer 1 leak test:**

- *Repair manual > Motor > Electric Drive Motor 0EF > 93 Electric drive > High-Voltage Battery Unit > High-Voltage Battery 1 AX2 Leak Test > Battery Housing Layer 1 and 2 Leak Test, 95 kWh / 115 kWh.*

- **Layer 2 leak test:**

- *Repair manual > Motor > Electric Drive Motor 0EF > 93 Electric drive > High-Voltage Battery Unit > High-Voltage Battery 1 AX2 Leak Test > Battery Housing Layer 2 Leak Test, 95 kWh / 115 kWh.*

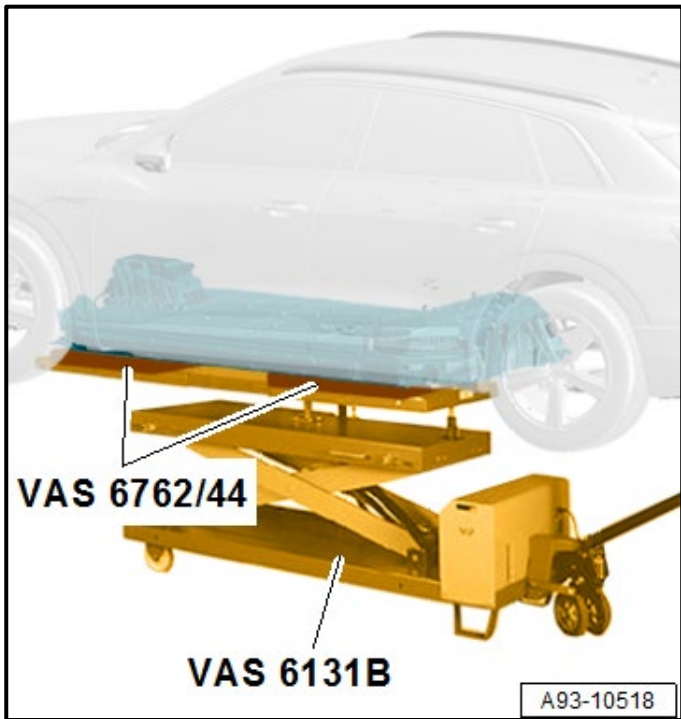

Re-install high-voltage battery:

- Installation is the reverse order of removal.
- See the ELSA Repair Manual: *Repair manual > Motor > Electric Drive Motor 0EF > 93 Electric drive > High-Voltage Battery Unit > High-Voltage Battery 1 AX2, Removing and Installing.*
- Torque the bolts for the high-voltage battery per the ELSA Repair Manual, using new bolts where specified:
 - *Repair manual > Motor > Electric Drive Motor 0EF > 93 Electric drive > High-Voltage Battery Unit > Overview - Installed High-Voltage Battery > Overview - Installed High-Voltage Battery, 95 kWh / 115 kWh*
- Use new hardware when specified by the repair manual.

| Part Number | Part Description |
|---------------|------------------|
| N -910-661-01 | Bolt (qty. 18) |
| N -912-721-01 | Bolt (qty. 2) |

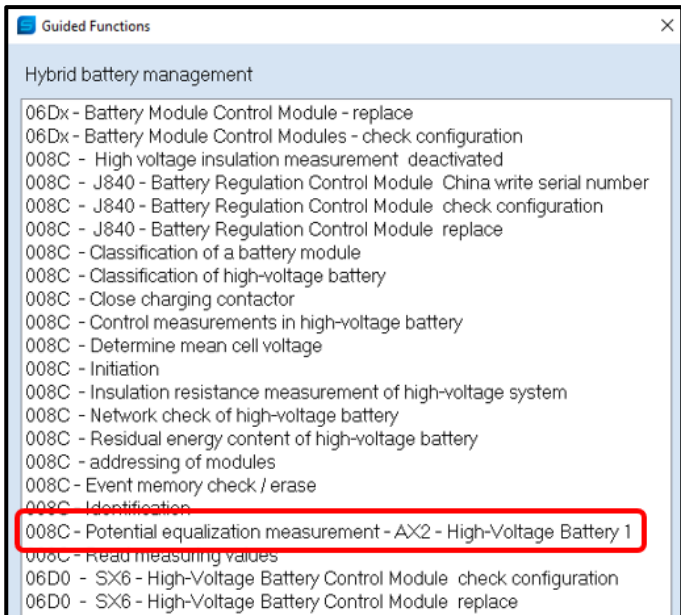

Perform potential equalization measurement:

- See the ELSA Repair Manual: *Repair manual > Motor > Electric Drive Motor 0EF > 93 Electric drive > Potential Equalization Cables > Potential Equalization Measurement.*
- Perform these steps in conjunction with Guided Function test plan, "008C - Potential equalization measurement - AX2 - High-Voltage Battery 1".

| Tests in current test plan | |
|----------------------------|--|
| Status | Tests (sorted according to chances of success) |
| > | J533 - Sequence error during operating mode setting - high voltage |
| > | J1050 - External charging infrastructure |
| | 0001 - Check warranty info |
| | 008C - Classification of high-voltage battery |
| | 008C - Classification of a battery module |
| | 008C - Initiation |
| | Establish high-voltage de-energization |
| | High-voltage re-energization |

Re-energize the high-voltage system:

DANGER

There is a risk of fatal injury due to high voltage. Electrocutation by direct contact or electric arc can cause severe bodily injury or fatal injury.

Have a high-voltage technician or a high-voltage expert bring the high-voltage system back into service.

- Reference the ELSA Repair Manual:
 - *Repair manual > Motor > Electric Drive Motor 0EF > 93 Electric drive > High-Voltage System, Re-Energizing.*
 - Perform these steps in conjunction with the test plan, “High-voltage re-energization”.

| Thermal management | |
|--------------------|---|
| | 00C5 - Adaptation |
| | 00C5 - Basic setting complete |
| | 00C5 - Bleed cooling circuit |
| | 00C5 - Check DTC memory |
| | 00C5 - Compressor break-in, automatic start |
| | 00C5 - Discharge A/C circuit, evacuate and charging |
| | 00C5 - Erase DTC memory |
| | 00C5 - Fill cooling circuit |
| | 00C5 - Flush refrigerant circuit |
| | 00C5 - Identification |
| | 00C5 - Output Diagnostic Test Mode (DTM) |
| | 00C5 - Potential Equalization Measurement, Electrical A/C Compressor -V470- |
| | 00C5 - Potential Equalization Measurement, High-Voltage Heater (PTC) -Z115- |
| | 00C5 - Potential Equalization Measurement, High-Voltage Heater 2 (PTC) -Z190- |

Fill and bleed the cooling system:

WARNING

Risk of damaging the assemblies due to insufficiently filling or bleeding.

- Never move or tow the vehicle without the cooling system full and the bleeding performed.
 - Bleed the cooling system even if only slightly filling after repair.
- Perform the steps below in conjunction with the following Guided Function test plans:
 - “00C5 - Fill cooling circuit”.
 - “00C5 – Bleed cooling circuit”.
 - Fill and bleed the cooling system per the ELSA Repair Manual:
 - *Repair manual > Motor > Electric Drive Motor 0EF > Cooling System/Coolant > Filling and Bleeding the Coolant > Coolant, Filling and Bleeding, with VAS 531 011.*

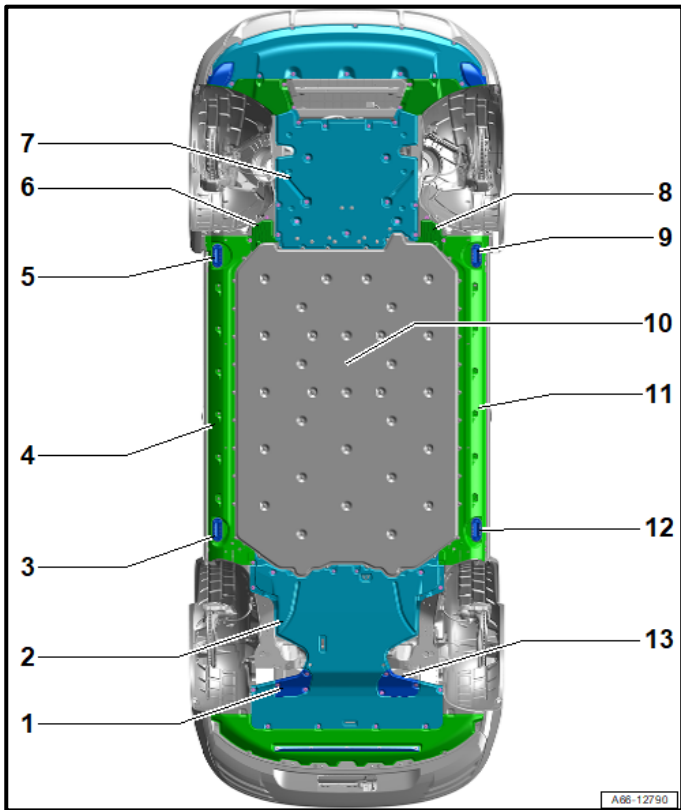

Reinstall underbody covers and impact guard:

- Installation is the reverse order of removal while noting the following:
 - Torque the impact guard per the ELSA Repair Manual: *Repair manual > Chassis > Suspension, Wheels, Steering > 40 Front Suspension > Overview – Subframe.*
 - Torque the underbody trim panels per the ELSA Repair Manual: *Repair manual > Body > Body Exterior > 66 Exterior Equipment > Underbody Trim Panel > Overview – Underbody Trim Panels.*
- Use new hardware when specified by the repair manual.
- Replace any damaged fasteners as needed

| Part Number | Part Description |
|---------------|------------------------------|
| N -106-421-04 | Impact guard bolt (qty. 2) |
| N -911-407-01 | Underbody trim bolt (qty. 2) |
| N -911-900-02 | Underbody trim bolt (qty. 2) |

| Tests in current test plan | |
|----------------------------|--|
| Status | Tests (sorted according to chances of success) |
| > | J533 - Sequence error during operating mode setting - high voltage |
| > | J1050 - External charging infrastructure |
| | 0001 - Check warranty info |
| | 008C - Classification of high-voltage battery |
| | 008C - Classification of a battery module |
| | 008C - Initiation |
| | Establish high-voltage de-energization |
| | High-voltage re-energization |

Perform classification of removed cell module(s):

CAUTION

There is danger of a health risk due to poisonous vapors, dust, and fluids.

Never work on high-voltage batteries that have a short circuit.

CAUTION

There is a risk of burns due to a hot high-voltage battery. It is possible to burn hands.

Wear safety gloves.

- Perform the steps below in conjunction with the test plan “008C - Classification of a battery module”.
- Classify the battery module per the ELSA Repair Manual:
 - *Repair manual > Motor > Electric Drive Motor 0EF > 93 Electric drive > High-Voltage Battery Components > Battery Module, Visual Inspection and Classification.*

This repair visit is complete.

US DEALERS - Proceed to Section D

CANADIAN DEALERS - Proceed to Section E

Section D - Parts Return/Disposal – US DEALERS ONLY

High-Voltage Battery Module(s):

Refer to the latest instructions for high-voltage battery recycling, found in Elsa2Go: *Elsa2Go-> Infomedia->Service References->Electric Vehicle Category ->“HV Battery Recycling Program Guide”*

All other parts:

Properly store (retain), destroy or dispose of removed parts in accordance with all state/province and local requirements, unless otherwise indicated and/or requested through the Warranty Parts Portal (WPP).

Section E - Parts Return/Disposal – CANADIAN DEALERS ONLY

High-Voltage Battery Module(s):

Refer to the latest version of TSB 2062871.

All other parts:

Properly store (retain), destroy or dispose of removed parts in accordance with all state/province and local requirements, unless otherwise indicated and/or requested through the Part Destruction and Core Disposition Report for Canada.