



HYUNDAI
Technical Service Bulletin

GROUP RECALL	NUMBER 24-01-027H-4
DATE MAY 2024	MODEL(S) SEE APPLICABLE MODEL LIST

SUBJECT: ANTI-LOCK BRAKING SYSTEM (ABS) FUSE REPLACEMENT
 (RECALL 251)

This TSB supersedes TSB#24-01-027H-3 to add 2014-2015MY Elantra (MD/UD), and 2014MY Elantra Coupe (JK).

★ IMPORTANT

Vehicle repairs related to safety recalls are critically important and must be performed properly in accordance with TSB procedures. Review this bulletin in its entirety prior to beginning any repair work.

As required by federal law, dealers must not deliver new vehicles for sale or for lease to customers until all open recalls have been performed. Dealers must also perform all open recalls on used vehicles, demo, and rental vehicles prior to placing them into customer use and whenever an affected vehicle is in the shop for any maintenance or repair.

Access the "Vehicle Information" screen via WebDCS to identify open recalls.

Description: The applicable vehicles listed below may develop an electrical short in the Anti-Lock Brake System (ABS) module, increasing the risk of an engine compartment fire. Follow the procedures in the bulletin to replace the ABS multi-fuse, the two individual ABS single fuses, or the ABS multi-fuse and a single fuse depending on the model.

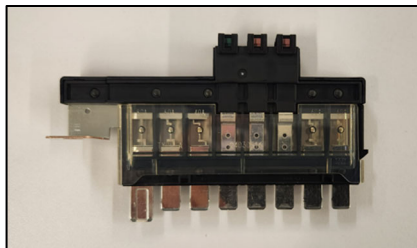



Applicable Vehicles (Certain):

- 2013MY Santa Fe Sport (AN) produced 7/12/2012 – 6/15/2013
- 2011-2015MY Sonata Hybrid (YF HEV) produced 12/02/2010 – 10/31/2014
- 2010-2012MY Veracruz (EN) produced 12/24/2009 – 10/08/2012
- 2014-2015MY Equus (VI) produced 4/12/2013 – 10/30/2014
- 2012-2015MY Accent (RB) produced 3/5/2011 – 10/31/2014
- 2013-2015MY Santa Fe (NC) produced 10/17/2012 – 10/31/2014
- 2012-2014MY Azera (HG) produced 11/29/2011 – 10/06/2014
- 2011-2015MY Elantra (MD) produced 11/12/2010 – 11/13/2014; VIN starts with 'KMH'
- 2011-2015MY Elantra (UD) produced 10/29/2010 – 10/31/2014; VIN starts with '5NP'
- 2013-2014MY Elantra Coupe (JK) produced 3/16/2012 – 4/24/2014
- 2010-2013MY Tucson (LM) produced 12/8/2009 – 8/19/2013

Parts Information:

Type	Model	Part Number	Figure
Multi-fuse only	Santa Fe Sport (AN)	91AN1-11200 QQH	Multi-fuse, upper cover, upper cover label
	Santa Fe (NC)	91NC1-11200 QQH	
	Accent (RB)	91RB2-11021 QQH	Multi-fuse, fuse labels
Single fuses only	Tucson (LM)	91LM1-11201 QQH	Multi-fuse, upper cover, upper cover label
	Sonata Hybrid (YF HEV)	91YF1-11020 QQH	2 single fuses (30A, 20A), fuse labels (small)
	Veracruz (EN)	91EN1-11020 QQH	2 single fuses (30A, 20A), fuse labels (small)
Equus (VI)	91VI1-11020 QQH		

<p>Both multi-fuse and single fuse</p>	<p>Azera (HG) 2012-14MY</p>	<p>91HG1-11201 QQH</p>	<p>Multi-fuse, 1 single fuse (20A), upper cover, upper cover label</p> 
	<p>Elantra (MD/UD) 2011-13MY</p> <p>Elantra Coupe (JK) 2013MY</p>	<p>91MD1-11200 QQH</p>	<p>Multi-fuse, 1 single fuse (20A), upper cover, upper cover label</p> 
	<p>Elantra (MD/UD) 2014-15MY</p> <p>Elantra Coupe (JK) 2014MY</p>	<p>91MD2-11200 QQH</p>	<p>Multi-fuse, 1 single fuse (20A), upper cover, upper cover label</p> 

Warranty Information:

Model	Op. Code	Operation	Op. Time	Casual Part	Nature Code	Cause Code
Sonata Hybrid (YF HEV)	41D013R0	ABS Single Fuse Installation	0.2 M/H	58920-4Z000	I11	ZZ3
Santa Fe Sport (AN)	41D013R1	ABS Multi-Fuse Installation	0.2 M/H	58920-4R000		
Veracruz (EN)	41D013R2	ABS Single Fuse Installation	0.2 M/H	58910-3J806		
Equus (VI)	41D013R3	ABS Single Fuse Installation	0.2 M/H	58910-3N590		
Santa Fe (NC)	41D013R4	ABS Multi-Fuse Installation	0.2 M/H	58920-B8700		
Accent (RB)	41D013R5	ABS Multi-Fuse Installation	0.2 M/H	58920-1R400		
Elantra (UD)	41D013R6	ABS Single & Multi-Fuse Installation	0.2 M/H	58920-3X700		
Elantra (MD)	41D013R7	ABS Single & Multi-Fuse Installation	0.2 M/H	58920-3X700		
Elantra Coupe (JK)	41D013R8	ABS Single & Multi-Fuse Installation	0.2 M/H	58920-3X660		
Tucson (LM)	41D013R9	ABS Multi-Fuse Installation	0.2 M/H	58920-2S400		
Azera (HG)	41D013RA	ABS Single & Multi-Fuse Installation	0.2 M/H	58920-3V300		

NOTE 1: Submit claim on Claim Entry Screen as “Campaign” type.

NOTE 2: If a part is found in need of replacement while performing this recall and the affected part is still under warranty, submit a separate claim using the same repair order. If the affected part is out of warranty, submit a Prior Approval request for goodwill consideration prior to performing the work.

NOTE 3: This TSB includes Repair validation photos. Op times include VIN, Mileage, and Repair validation photo(s) as outlined in the Digital Documentation Policy.

NOTE 4: The incident parts are subject to callback through the normal Warranty Technical Center (WTC) parts return process. **Claim is subject to debit if the part is not returned.**

Service Procedures Table of Contents:

Replacement of Multi-fuse:.....6
Replacement of Two Single Fuses:..... 11
Replacement of Single Fuse & Multi-Fuse: 15

STUI



This TSB includes Repair validation photos. Refer to the latest Warranty Digital Documentation Policy for requirements.

i Information

Refer to the QR code or link below for guided video information:
[Hyundai Service Learning – Recall 251 Service Procedure](#)



i Information

If the “ABS”, “ESC”, or “Brake” indicator lights are illuminated, refer to the appropriate section in the shop manual for diagnosis **before** performing this Recall.

Replacement of Multi-fuse: Santa Fe Sport (AN), Santa Fe (NC), Accent (RB), Tucson (LM)

Multi-Fuse Table:

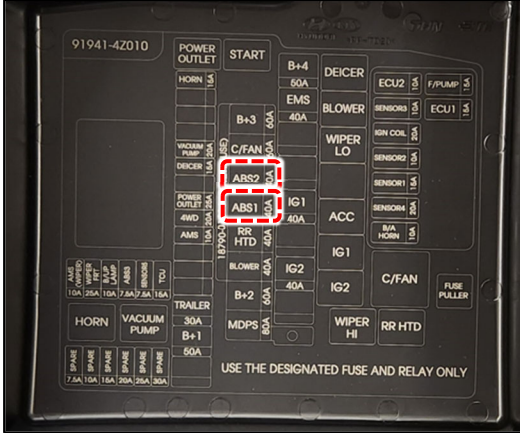
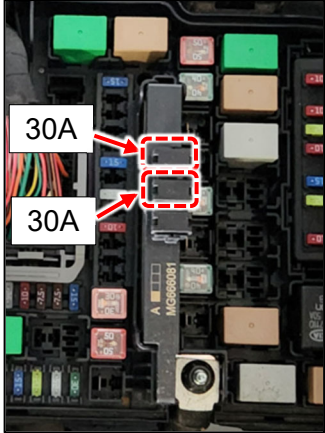
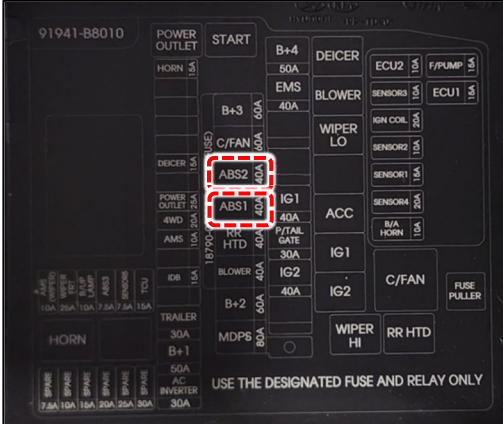
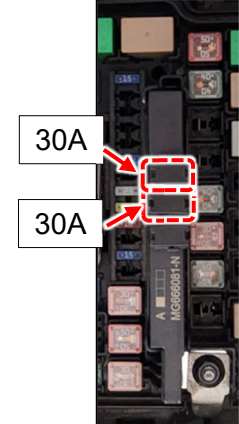
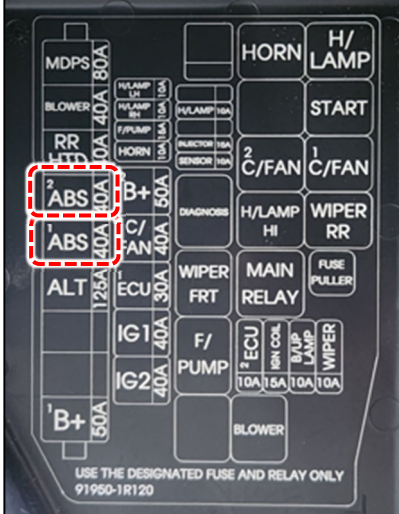
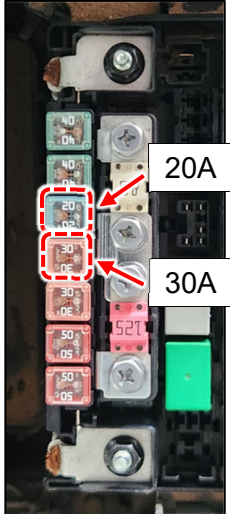
Model	Fuse Changes	Images	
<p>Santa Fe Sport (AN)</p>	<p>ABS1: 40A → 30A ABS2: 40A → 30A</p>		
<p>Santa Fe (NC)</p>	<p>ABS1: 40A → 30A ABS2: 40A → 30A</p>		
<p>Accent (RB)</p>	<p>ABS1: 40A → 30A ABS2: 40A → 20A</p>		

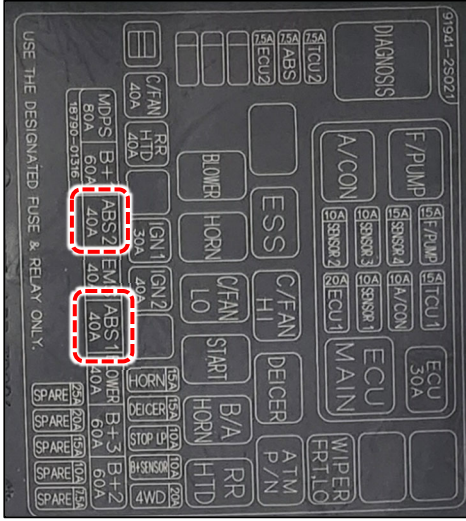
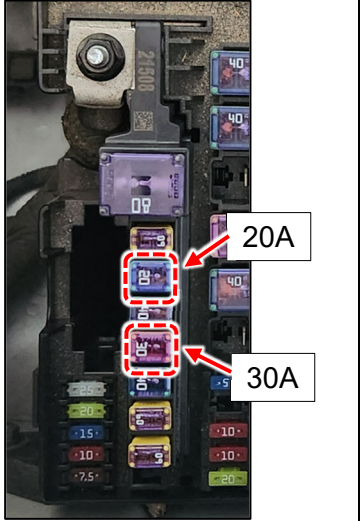
<p>Tucson (LM)</p>	<p>ABS1: 40A → 30A ABS2: 40A → 20A</p>	 <p>Diagram of the fuse block with labels for various components. Two fuses are highlighted with red dashed boxes: one labeled 'ABS1 40A' and another labeled 'ABS2 40A'. The diagram includes labels for components like DIAGNOSIS, F/PUMP, A/CON, ECU, and various sensors.</p>	 <p>Close-up photograph of the fuse block. Two fuses are highlighted with red dashed boxes and labeled with red arrows: '20A' and '30A'.</p>
--------------------	--	---	---

Service Procedure:

i Information

Unless otherwise specified, fuse values and images shown are for Santa Fe Sport (AN). Refer to the Multi-Fuse Table for the specific model fuse locations and values.

- Record customer's radio presets, then disconnect the negative (-) battery terminal.

Tightening Torque:

lb-ft	3.7
lb-in	44
N.m	5

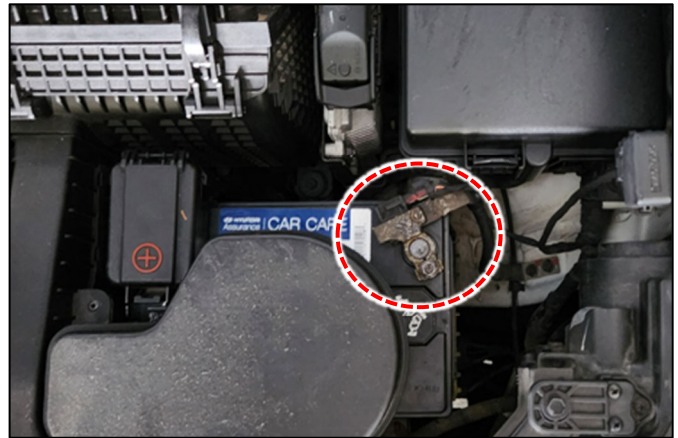

- Locate the junction box and remove the cover.

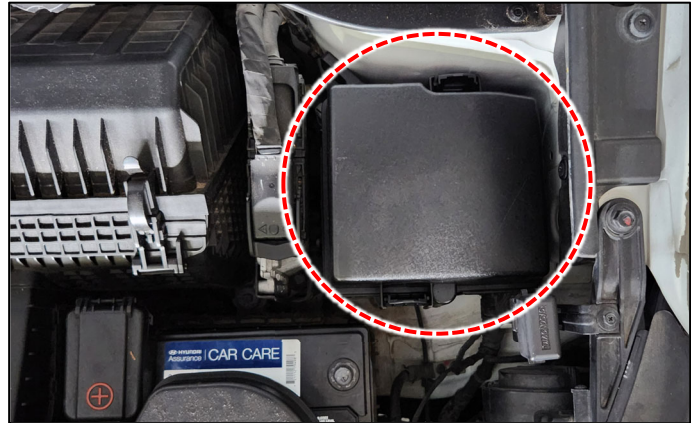

3a. For Santa Fe Sport (AN), Santa Fe (NC), and Tucson (LM) vehicles:

Remove the multi-fuse nut and junction box cable. Release the locking tab and remove the multi-fuse.

Tightening Torque:

lb-ft	8.0
lb-in	96
N.m	11

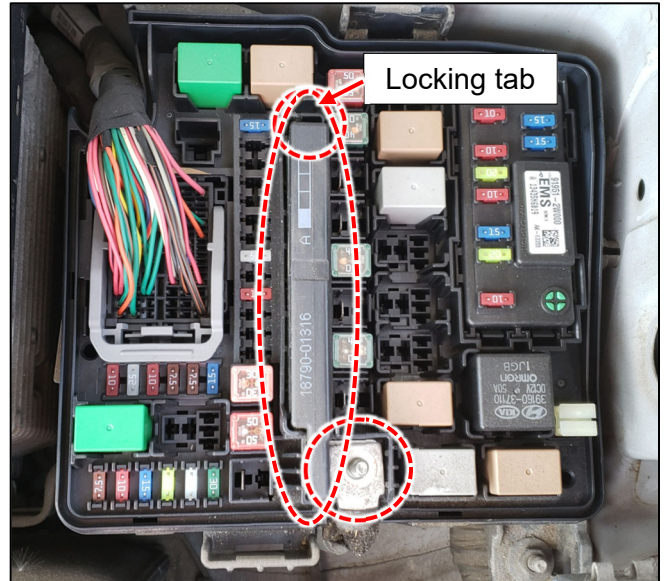

3b. For Accent (RB) vehicles:

Remove the two multi-fuse nuts and junction box cables. Release the locking tab and remove the multi-fuse.

Tightening Torque:

lb-ft	8.0
lb-in	96
N.m	11

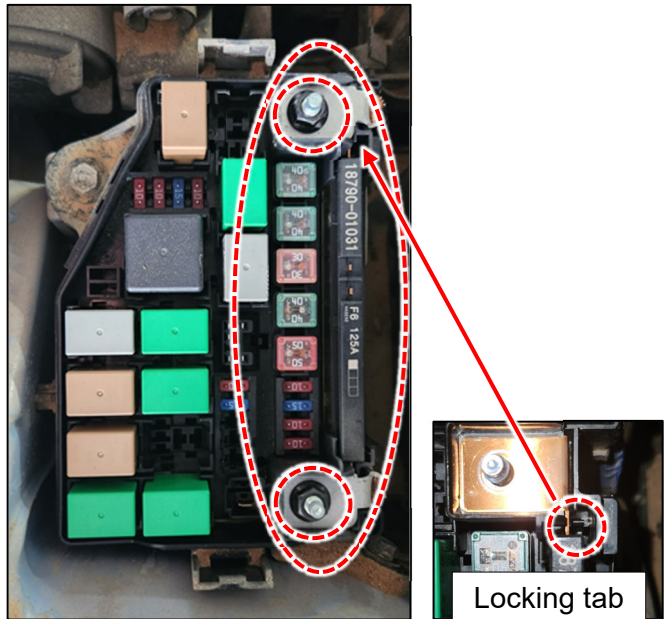

4. Install the new multi-fuse, placing the junction box cable(s) over the junction box stud(s). Reinstall the nut(s).

i Information

Multi-fuse shown is for Santa Fe Sport (AN). Refer to the Multi-Fuse Table for the specific model multi-fuse location.

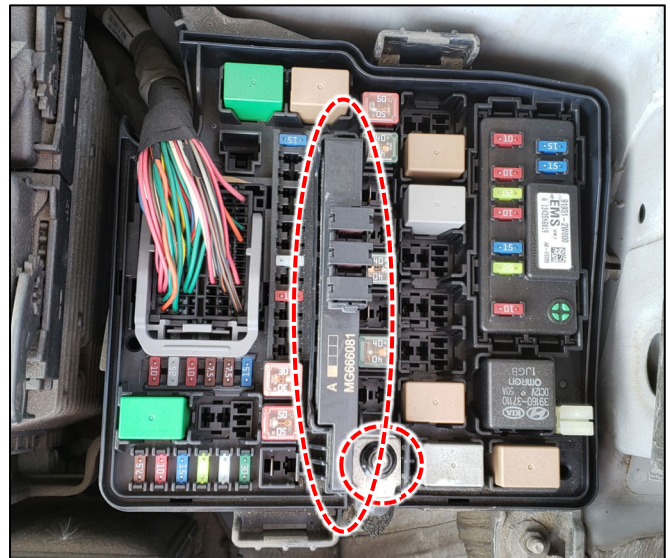

- 5a. For Santa Fe Sport (AN), Santa Fe (NC), and Tucson (LM) vehicles:

Clean the surface, then attach the supplied label to the new upper cover.

i Information

Fuse label shown is for Santa Fe Sport (AN). Refer to the Multi-Fuse Table for the specific model fuse value changes.

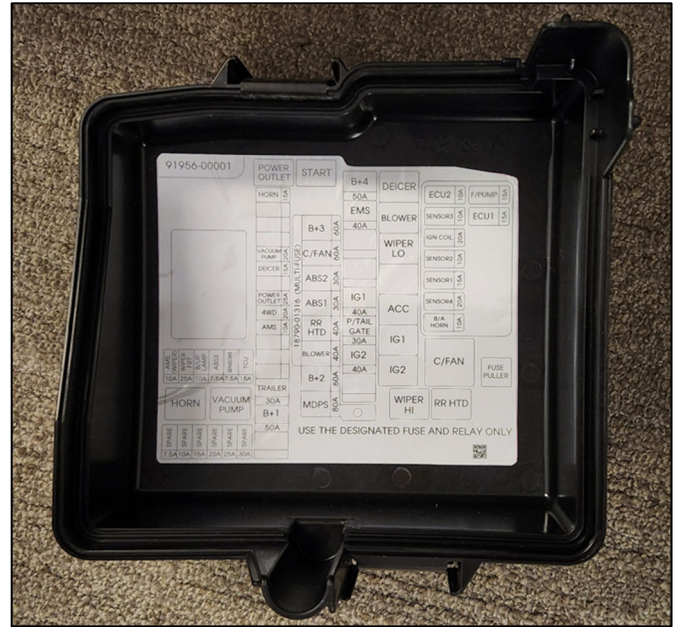

- 5b. For Accent (RB) vehicles:

Clean the surface, then attach the supplied label to the original upper cover.

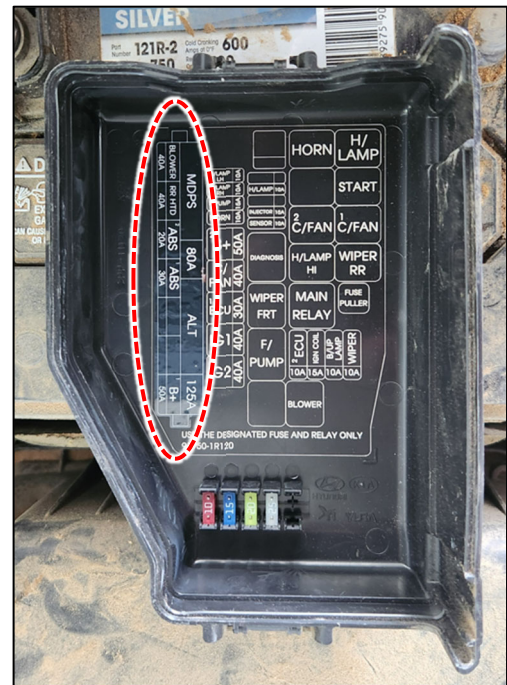

6.

STUI

Using STUI, take one photo with the last 6 digits of the VIN and the date of repair on a piece of paper. Photo must show:

- New multi-fuse installed in junction box
- Junction box cover with newly applied label

Upload the photo to STUI.

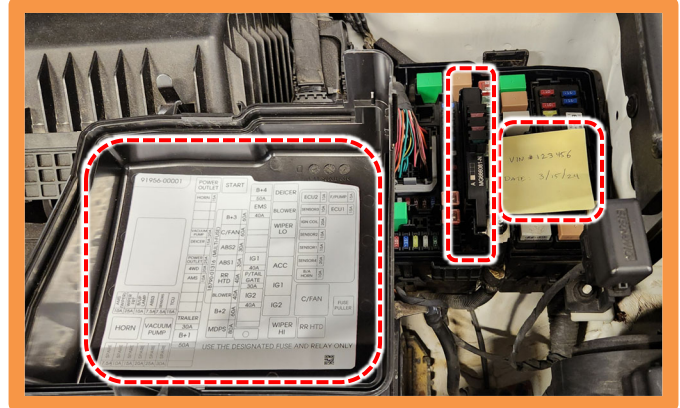

Example of STUI Photo

7. Install the new junction box upper cover.
8. Reconnect the negative (-) battery terminal.
9. Reset customer's radio presets.
10. Start the engine to confirm proper operation.
11. Service procedure is now complete.

Replacement of Two Single Fuses: Sonata Hybrid (YF HEV), Veracruz (EN), Equus (VI)

Single Fuse Table:

Model	Fuse Changes	Images
<p>Sonata Hybrid (YF HEV)</p>	<p>ESC1: 40A → 30A ESC2: 30A → 20A</p>	
<p>Veracruz (EN)</p>	<p>ABS1: 40A → 30A ABS2: 40A → 20A</p>	
<p>Equus (VI)</p>	<p>ESC1: 40A → 30A ESC2: 40A → 20A</p>	

Service Procedure:

***i* Information**

Fuse values and images shown are for Sonata Hybrid (YF HEV). Refer to the Single Fuse Table for the specific model fuse locations and values.

- Record customer's radio presets, then disconnect the negative (-) battery terminal.

Tightening Torque:

lb-ft	3.7
lb-in	44
N.m	5



- From the engine compartment, locate the junction box and remove the cover.



- Locate the ABS1/ESC1 and ABS2/ESC2 fuses. Remove the two fuses.

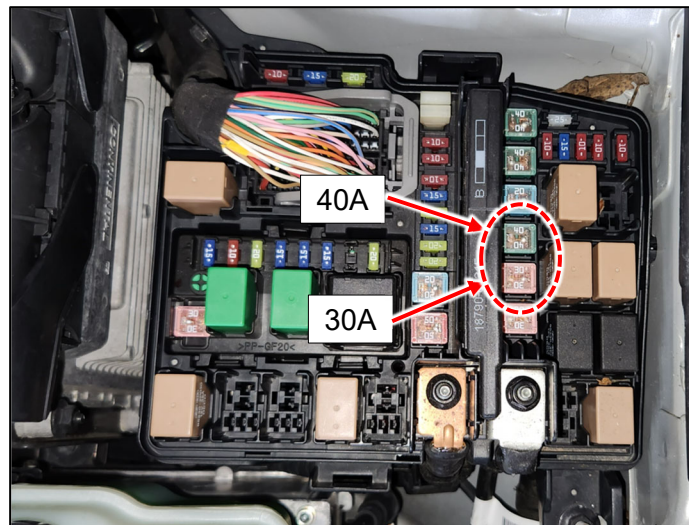
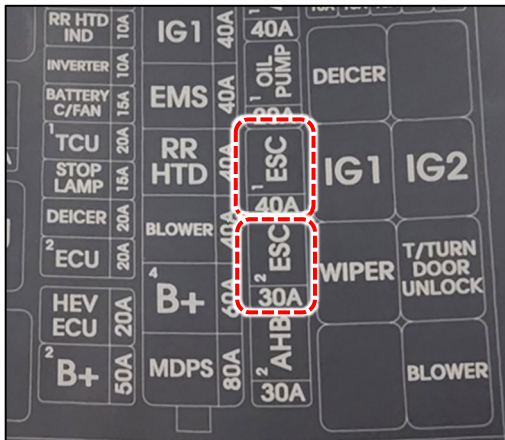

- Install the two new single fuses as shown.

ESC1 position (40A fuse originally)
Install new 30A fuse (pink).

ESC2 position (30A fuse originally):
Install 20A fuse (blue).

i Information

Fuse values shown are for Sonata Hybrid (YF HEV). Refer to the Single Fuse Table for the specific model fuse locations and values.

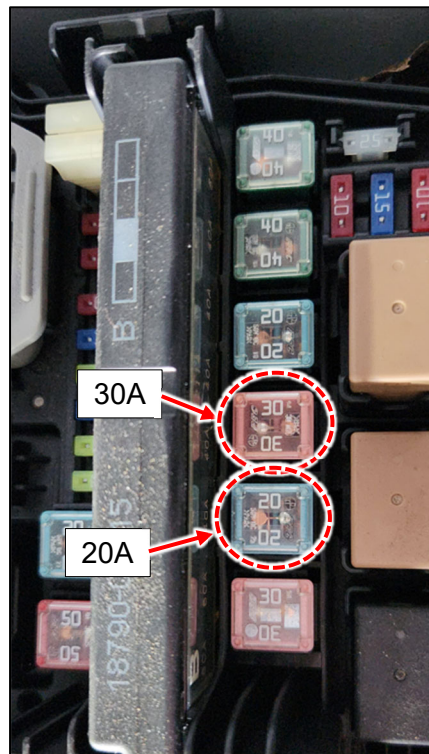

- Select the appropriately sized labels with the corresponding amperage values for the two fuses installed.

Clean the surface, then attach the supplied labels to the junction box cover as shown.

i Information

Fuse values shown are for Sonata Hybrid (YF HEV). Refer to the Single Fuse Table for the specific model fuse locations and values.

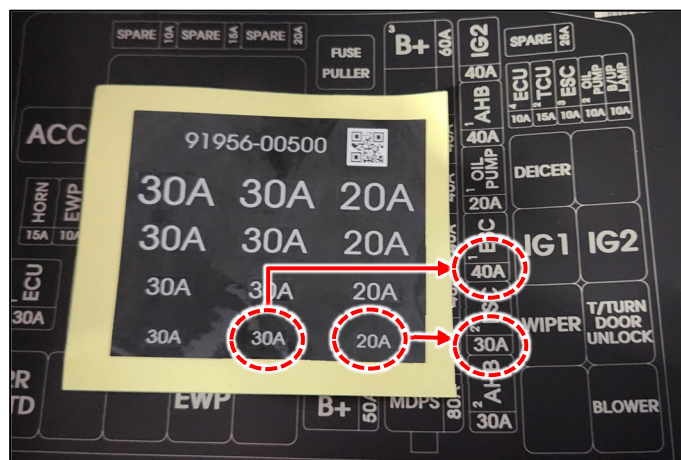

6.

STUI

Using STUI, take one photo with the last 6 digits of the VIN and the date of repair on a piece of paper. Photo must show:

- New fuses installed in junction box
- Junction box cover with newly applied labels

Upload the photo to STUI.

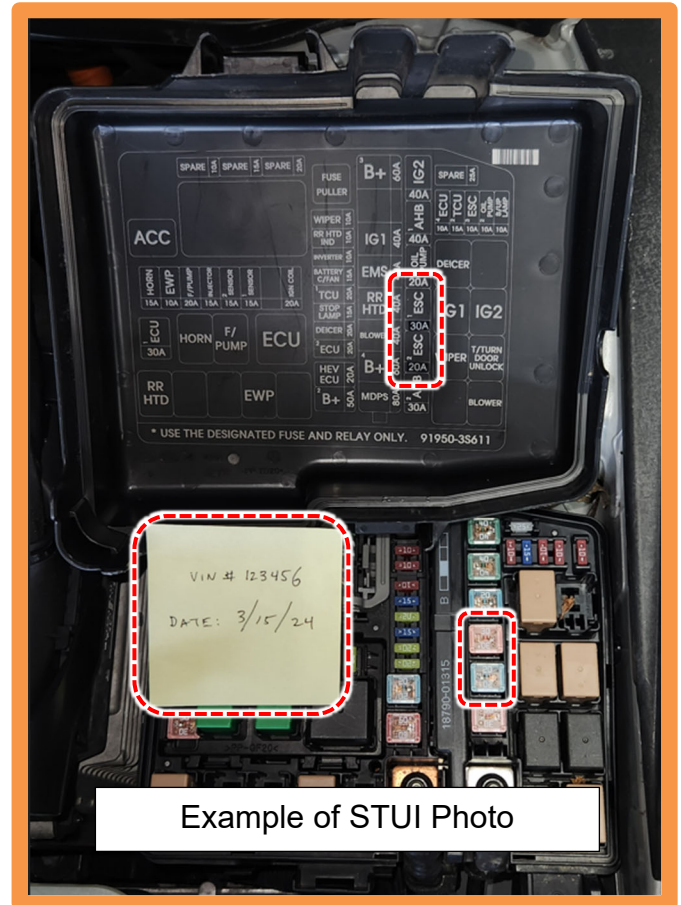

7. Reinstall the junction box cover.
8. Reconnect negative battery terminal.
9. Reset customer's radio presets.
10. Start the engine to confirm proper operation.
11. Service procedure is now complete.

Replacement of Single Fuse & Multi-Fuse: Azera (HG), Elantra (MD/UD), Elantra Coupe (JK)

Single & Multi-Fuse Table:

i Information

Azera (HG), Elantra (MD & UD) and Elantra Coupe (JK) have some fuse layout differences for different model years. The included upper cover label reflects these differences for each kit part number.

The ESC/ABS fuses, however, do not change positions for different model years. The table below illustrates the ESC/ABS fuse locations and value changes for all model years of the specified model.

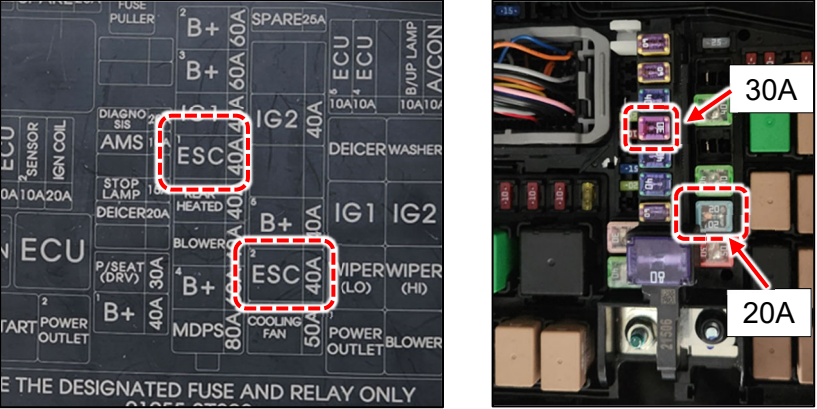
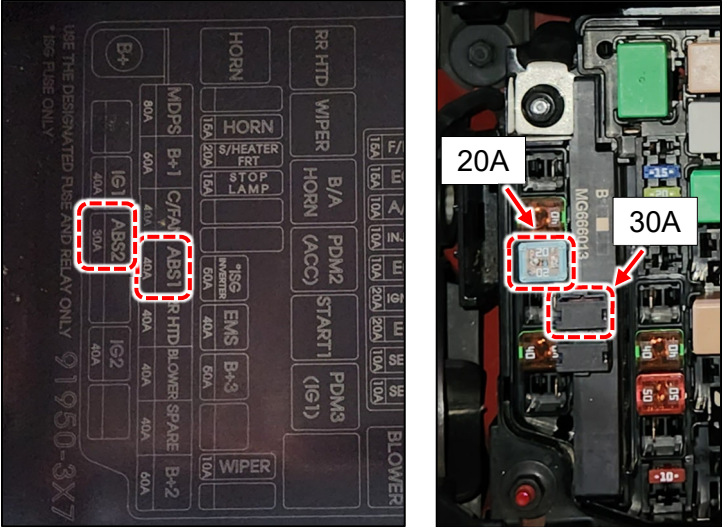
Model	Fuse Changes	Images
Azera (HG)	ESC1: 40A → 30A ESC2: 40A → 20A	
Elantra (MD/UD) & Elantra Coupe (JK)	ABS1: 40A → 30A ABS2: 30A → 20A	

Service Procedures:

i

Information

Unless otherwise specified, fuse values and images shown are for Elantra Coupe (JK). Refer to the Single & Multi-Fuse Table for the specific model fuse locations and values.

1. Record customer's radio presets, then disconnect the negative (-) battery terminal.

Tightening Torque:

lb-ft	3.7
lb-in	44
N.m	5



2. From the engine compartment, locate the junction box and remove the cover.



3a. For Elantra (MD/UD) and Elantra Coupe (JK) vehicles:

Remove the multi-fuse nut and junction box cable. Release the locking tab and remove the multi-fuse.

Tightening Torque:

lb-ft	8.0
lb-in	96
N.m	11

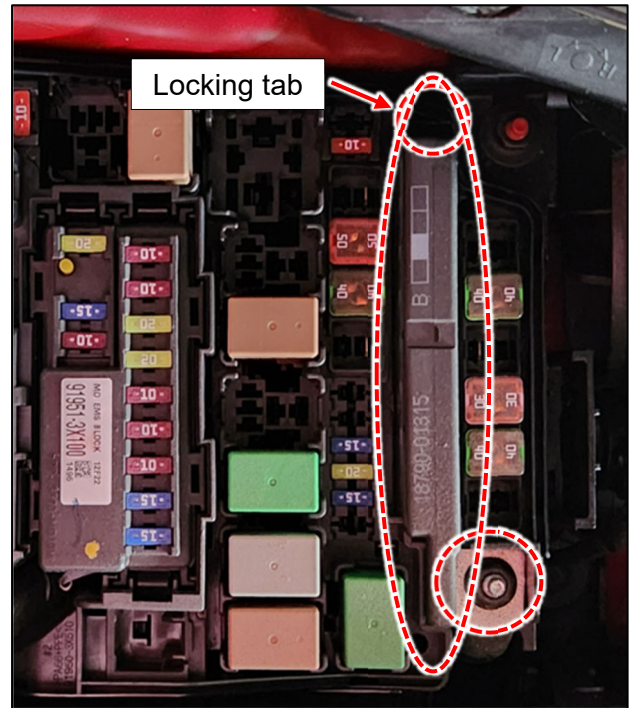

3b. For Azera (HG) vehicles:

Remove the multi-fuse mounting nut cover by releasing the locking tab and lifting the cover upwards.

Remove the multi-fuse nut. Release the locking tab and remove the multi-fuse.

Tightening Torque:

lb-ft	8.0
lb-in	96
N.m	11

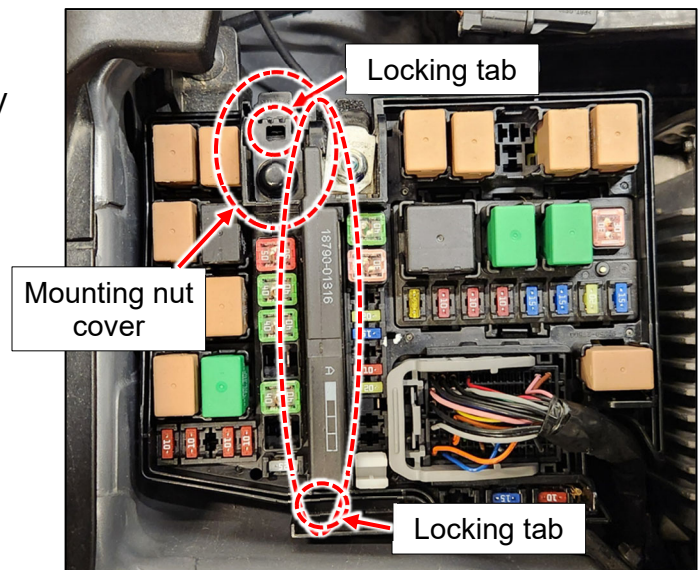

4. Locate the ABS2 single fuse. Remove the fuse.

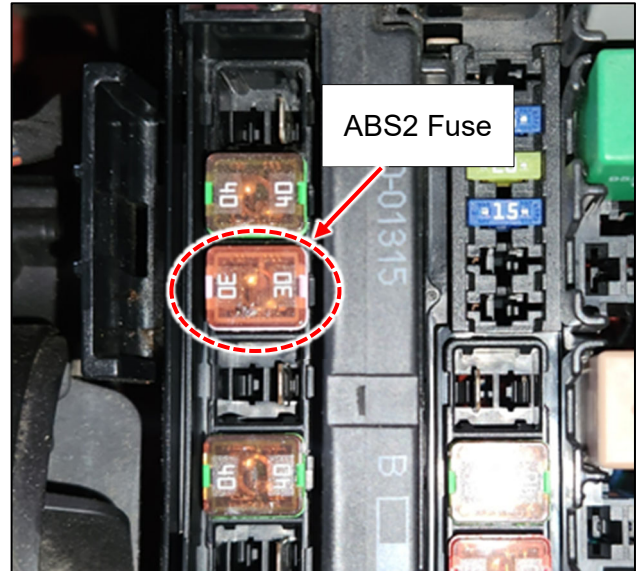
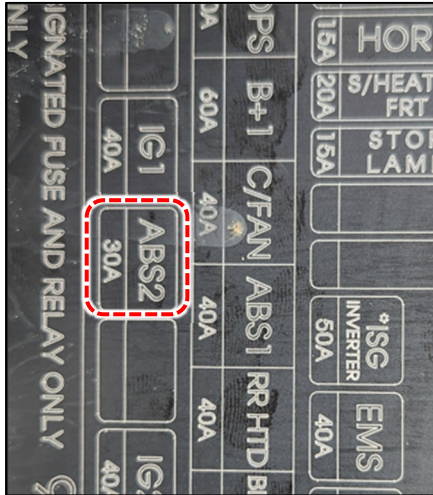

i Information

Single fuse shown is for Elantra Coupe (JK). Refer to the Single & Multi-Fuse Table for the specific model single fuse location.

5. Install the new single fuse as shown.

ABS2 position (30A fuse originally):
Install 20A fuse (blue).

i Information

Fuses shown are for Elantra Coupe (JK). Refer to the Single & Multi-Fuse Table for the specific model fuse locations.

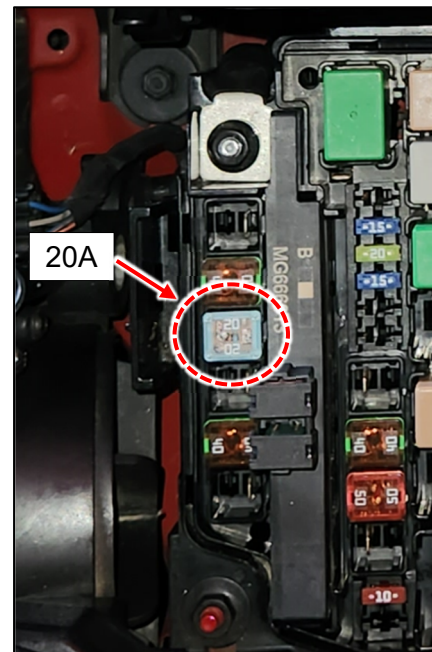

6. Install the new multi-fuse.

For Elantra (MD/UD) and Elantra Coupe (JK) vehicles:

Place the junction box cable over the junction box stud. Reinstall the nut.

For Azera (HG) vehicles:

Reinstall the multi-fuse mounting nut cover. Reinstall the nut.

i Information

Fuses shown are for Elantra Coupe (JK). Refer to the Single & Multi-Fuse Table for the specific model fuse locations.

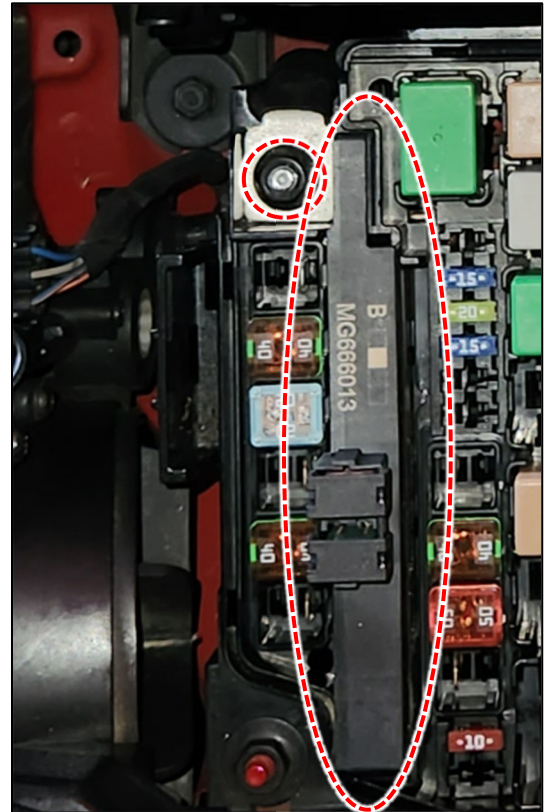

7. Clean the surface, then attach the supplied label to the new upper cover.

i Information

Fuse label shown is for Elantra Coupe (JK). Refer to the Single & Multi-Fuse Table for the specific model fuse value changes.



8.

STUI

Using STUI, take one photo with the last 6 digits of the VIN and the date of repair on a piece of paper. Photo must show:

- New multi-fuse installed in junction box
- New single fuse installed in the junction box
- Junction box cover with newly applied label

Upload the photo to STUI.

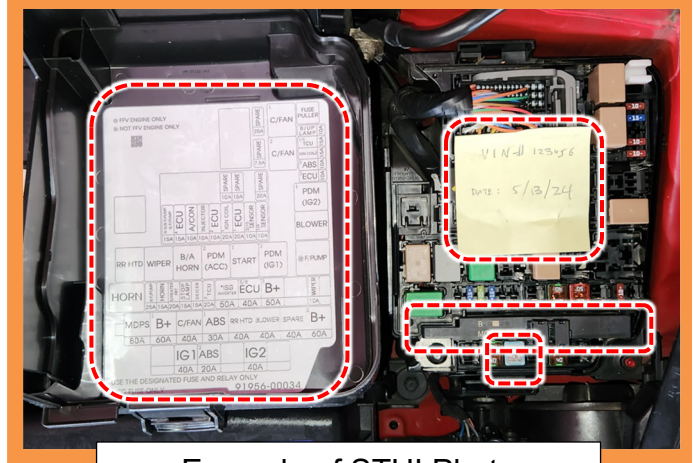

Example of STUI Photo

9. Reinstall the junction box cover.
10. Reconnect negative battery terminal.
11. Reset customer's radio presets.
12. Start the engine to confirm proper operation.
13. Service procedure is now complete.