

Safety Recall

Code: 93T7



Subject	High Voltage Battery				
Document History	Date		Summary		
	12/19/2023		Updated claiming and work instructions		
	10/31/2023		Original publication		
Affected Vehicles	Country	Beginning Model Year	Ending Model Year	Vehicle	Vehicle Count
	USA	2023	2023	E-TRON GT	1,438
	USA	2023	2023	RS E-TRON GT	461
	CAN	2023	2023	E-TRON GT	192
	CAN	2023	2023	RS E-TRON GT	42
	<p>Check Campaigns/Actions screen in Elsa on the day of repair to verify that a VIN qualifies for repair under this action. Elsa is the <u>only</u> valid campaign inquiry & verification source.</p> <ul style="list-style-type: none"> ✓ Campaign status must show "open." ✓ If Elsa shows other open action(s), inform your customer so that the work can also be completed at the same time the vehicle is in the workshop for this campaign. 				
Problem Description	Under certain circumstances, there is a possibility that, over time, liquid can intrude into the high voltage battery of certain vehicles. Over time, if a sufficient amount of conductive liquid accumulates in the battery, arcing can occur, which could increase the risk of a fire.				
Corrective Action	Conduct leak testing to detect the potential for leakage into the battery. If testing indicates the potential for leakage, the battery will be replaced.				
Precautions:	<p>If liquid enters the battery, a drop in insulation resistance results. If the insulation resistance value drops below a defined threshold over time, a yellow warning message is displayed in the vehicle. If the insulation value continues to drop below a defined threshold over time, a red warning message is displayed in the vehicle.</p> <p>Customers experiencing this situation are advised to contact their authorized Audi dealer without delay for an appointment to have the vehicle diagnosed.</p> <p>As a reminder, the vehicle owner's manual contains important information regarding the vehicle's warning lights and messages. We encourage anyone who drives the vehicle to review the owner's manual to become familiar with the types of vehicle indicators, warnings and messaging they may see.</p>				
Code Visibility	On September 07, 2023, the campaign code was applied to affected vehicles.				
Owner Notification	Owner notification will take place in October 2023. Owner letter examples are included in this bulletin for your reference.				
Additional Information	<p>Please alert everyone in your dealership about this action, including Sales, Service, Parts and Accounting personnel. Contact Warranty if you have any questions.</p> <p>IMPORTANT REMINDER ON VEHICLES AFFECTED BY SAFETY & COMPLIANCE RECALLS</p> <p><u>New Vehicles in Dealer Inventory:</u> It is a violation of federal law for a dealer to deliver a new motor vehicle or any new or used item of motor vehicle equipment (including a tire) covered by this notification under a sale or lease until the defect or noncompliance is remedied. By law, dealers must correct, prior to delivery for sale or lease, any vehicle that fails to comply</p>				

The repair information in this document is intended for use only by skilled technicians who have the proper tools, equipment and training to correctly and safely maintain your vehicle. These procedures are not intended to be attempted by "do-it-yourselfers," and you should not assume this document applies to your vehicle, or that your vehicle has the condition described. To determine whether this information applies, contact an authorized Audi dealer. ©2023 Audi of America, Inc. and Audi Canada. All Rights Reserved.

with an applicable Federal Motor Vehicle Safety Standard or that contains a defect relating to motor vehicle safety.

Pre-Owned Vehicles in Dealer Inventory: Dealers should not deliver any pre-owned vehicles in their inventory which are involved in a safety or compliance recall until the defect has been remedied.

Dealers must ensure that every affected inventory vehicle has this campaign completed before delivery to consumers.

Parts Information

HV Battery Inspection:

Criteria	Quantity	Part Number	P.O.C. Part Description	Ordering Method (see description below)
F8	1	9J1-915-754	VALVE	Free Order
	4	N -107-002-01	BOLT	

HV Battery Replacement (if necessary):

Criteria	Quantity	Part Number	P.O.C. Part Description	Ordering Method (see description below)
F8	1	9J1-915-100-BC	BATTERY (confirm part number in ETKA)	e-mail parts specialist
	2	WHT-010-074	PLUG	Free Order
	1	12E-010-006	WARN. SIGN	
	1	12E-010-006-A	WARN. SIGN	
	As Needed	G 12E1001G CON	COOLANT (U.S. ONLY)	
		G 12E1002G CON	COOLANT (CANADA ONLY)	

Parts Control Type:
Free Order

Parts will be managed by Free Order

Initial Allocation:
NO

There will be no parts allocation. Please reference the Repair Projection Tool (below) to view your potential VIN population.

Parts Control Type:
e-mail parts specialist

Prior to placing an order for the high voltage battery, a TAC case must be opened. Orders will then be placed by e-mailing VWoAPartsSpecialists@vw.com

Repair Projection Tool:
(right click to open)



! NOTE

Campaign parts should always be ordered as per the parts information in this circular. The ordering system will supersede the part, if applicable.

Claim Entry Instructions

The labor times listed here may differ from the labor operations and labor times listed in ELSA.

After campaign has been completed, enter claim as soon as possible to help prevent work from being duplicated elsewhere. Attach the Elsa screen print showing action open on the day of repair to the repair order.

If customer refused campaign work:

- ✓ U.S. dealers: Submit the request through Audi Warranty Online under the Campaigns/Update option.
- ✓ Canada dealers: Upload the repair order [signed by customer] to Audi WIN/Operations/Campaign Closure.

Service Number	93T7		
Damage Code	0099		
Parts Vendor Code	002		
Claim Type	Sold vehicle: 7 10 Unsold vehicle: 7 90		
Causal Indicator	Mark VALVE* as causal if HV battery is OK Mark BATTERY* as causal if HV battery is NOT OK		
Vehicle Wash/Loaner	Do not claim wash/loaner under this action		
Criteria I.D.	F8		
	Perform HV battery leak test.		
	LABOR		
	Labor Op	Time Units	Description
	2706 89 50	SEE ELSA	Connect battery charger
	6644 19 50	SEE ELSA	Cowl panel trim remove+reinstall
	9303 01 52	SEE ELSA	High voltage battery check (classification)
	9310 83 50	SEE ELSA	Disable HV system voltage deactivate and activate (Diagnostic activation HV System)
	7006 19 00	SEE ELSA	Luggage compartment rear trim remove+reinstall
	5192 19 99	30	Remove + reinstall front cover
	9303 01 99	40	Perform high voltage battery leak test (can be claimed up to 3 times)
	9309 37 99	70	Preparation for checking high-voltage battery while installed
	0150 00 00	Time stated on diagnostic protocol	GFF Operations

Continued on next page

PARTS			
Quantity	Part Number	Description	
1.00	9J1915754	VALVE*	
4.00	N 10700201	ROUND HD. SCREW	
<i>NOTE: If the high voltage battery is replaced, these parts will not be used and should not be claimed.</i>			

AND (ONLY IF NECESSARY)	ADD the following labor and parts if HV battery requires replacement.		
	LABOR		
	Labor Op	Time Units	Description
	9303 19 50	SEE ELSA	High voltage battery remove+reinstall
	9303 55 50	SEE ELSA	High voltage battery replace
	1938 17 50	SEE ELSA	Coolant drain+fill
	9302 03 50	SEE ELSA	Battery housing measure
	PARTS		
	Quantity	Part Number	Description
	1	9J1915100BC	BATTERY*
	1	12E010006	WARN. SIGN
	1	12E010006A	WARN. SIGN
	Up to 90.00	G 12E100S1	COOLANT (concentrate)
	2	WHT010074	PLUG

AND	The following part number can be claimed ONE TIME per dealer Additional claims will be cancelled		
	PARTS (Special Tool / Adapter)		
	Quantity	Part Number	Description
	1.00	4J3998099	Adapter

Customer Letter Example (USA)

<MONTH YEAR>

<CUSTOMER NAME>

<CUSTOMER ADDRESS>

<CUSTOMER CITY STATE ZIPCODE>

This notice applies to your vehicle: <MODEL YEAR> <BRAND> <CARLINE>, <VIN>

NHTSA: 23V613

Subject: Safety Recall 93T7 - High Voltage Battery

Dear Audi Owner,

This notice is sent to you in accordance with the National Traffic and Motor Vehicle Safety Act. Audi has decided that a defect, which relates to motor vehicle safety, exists in certain 2023 model year Audi vehicles. Our records show that you are the owner of a vehicle affected by this action.

What is the issue? Under certain circumstances, there is a possibility that, over time, liquid can intrude into the high voltage battery of certain vehicles. Over time, if a sufficient amount of conductive liquid accumulates in the battery, arcing can occur, which could increase the risk of a fire.

What will we do? To correct this defect, your authorized Audi dealer will conduct leak testing to detect the potential for leakage into the battery. If testing indicates the potential for leakage, the battery will be replaced.

Testing will take about half a day to complete. Battery replacement, if necessary, will take up to one day to complete. Both the testing and battery replacement (if necessary) will be performed for you free of charge. Please keep in mind that your dealer may need additional time for the preparation of the work, as well as to accommodate their daily workshop schedule.

What should you do? Please contact your authorized Audi dealer without delay to schedule this recall work. For your convenience, you can also visit www.audiusa.com and click on the "Find a Dealer" link to locate a dealer near you and schedule this service.

Precautions you should take If liquid enters the battery, a drop in insulation resistance results. If the insulation resistance value drops below a defined threshold over time, a yellow warning message is displayed in the vehicle. If the insulation value continues to drop below a defined threshold over time, a red warning message is displayed in the vehicle.

Customers experiencing this situation are advised to contact their authorized Audi dealer without delay for an appointment to have the vehicle diagnosed.

As a reminder, the vehicle owner's manual contains important information regarding the vehicle's warning lights and messages. We encourage anyone who drives the vehicle to review the owner's manual to become familiar with the types of vehicle indicators, warnings and messaging they may see.

Lease vehicles and address changes If you are the lessor and registered owner of the vehicle identified in this action, the law requires you to forward this letter immediately via first-class mail to the lessee within ten (10) days of receipt. If you have changed your address or sold the vehicle, please fill out the enclosed prepaid Owner Reply card and mail it to us so we can update our records.

Can we assist you further? If your authorized Audi dealer fails or is unable to complete this work free of charge within a reasonable time, please contact Audi Customer Experience at 1-800-253-2834 or via our "Contact Us" page at www.audiusa.com.

Checking your vehicle for open Recalls and Service Campaigns To check your vehicle's eligibility for repair under this or any other recall/service campaign, please visit the **Recall/Service Campaign Lookup** tool at www.audiusa.com and enter your Vehicle Identification Number (VIN).

If you still cannot obtain satisfaction, you may file a complaint with: The Administrator, National Highway Traffic Safety Administration, 1200 New Jersey Avenue, SE., Washington, DC 20590; or call the toll-free Vehicle Safety Hotline at 1-888-327-4236 (TTY: 1-800-424-9153); or go to <http://www.safercar.gov>.

We apologize for any inconvenience this matter may cause; however we are taking this action to help ensure your safety and continued satisfaction with your vehicle.

Sincerely,

Audi Customer Protection

Customer Letter Example (Canada)

<MONTH YEAR>

<CUSTOMER NAME>

<CUSTOMER ADDRESS>

<CUSTOMER CITY STATE ZIPCODE>

This notice applies to your vehicle: <MODEL YEAR> <BRAND> <CARLINE>, <VIN>

Transport Canada Recall: 2023-492

Subject: Safety Recall 93T7 - High Voltage Battery

Dear Audi Owner,

This notice is sent to you in accordance with the requirements of the *Motor Vehicle Safety Act*. This is to inform you that your vehicle may contain a defect that could affect the safety of a person. Our records show that you are the owner of a vehicle affected by this action.

What is the issue? Under certain circumstances, there is a possibility that, over time, liquid can intrude into the high voltage battery of certain vehicles. Over time, if a sufficient amount of conductive liquid accumulates in the battery, arcing can occur, which could increase the risk of a fire.

What will we do? To correct this defect, your authorized Audi dealer will conduct leak testing to detect the potential for leakage into the battery. If testing indicates the potential for leakage, the battery will be replaced.

Testing will take about half a day to complete. Battery replacement, if necessary, will take up to one day to complete. Both the testing and battery replacement (if necessary) will be performed for you free of charge. Please keep in mind that your dealer may need additional time for the preparation of the work, as well as to accommodate their daily workshop schedule.

What should you do? Please contact your authorized Audi dealer without delay to schedule this recall work.

Precautions you should take If liquid enters the battery, a drop in insulation resistance results. If the insulation resistance value drops below a defined threshold over time, a yellow warning message is displayed in the vehicle. If the insulation value continues to drop below a defined threshold over time, a red warning message is displayed in the vehicle.

Customers experiencing this situation are advised to contact their authorized Audi dealer without delay for an appointment to have the vehicle diagnosed.

As a reminder, the vehicle owner's manual contains important information regarding the vehicle's warning lights and messages. We encourage anyone who drives the vehicle to review the owner's manual to become familiar with the types of vehicle indicators, warnings and messaging they may see.

Lease vehicles and address changes If you are the lessor and registered owner of the vehicle identified in this letter, you shall forward this letter (and any subsequent notice, if applicable) to the lessee within ten (10) days of receipt. If you have changed your address or sold the vehicle identified in this letter, please fill out the enclosed prepaid Owner Reply Card and mail it to us so we can update our records.

Can we assist you further? If your authorized Audi dealer fails or is unable to complete this work free of charge within a reasonable time, please contact Audi Customer Relations Monday through Friday from 8AM to 8PM EST at 1-800-822-2834 or via our "Contact Audi Canada" page at www.audi.ca.

We apologize for any inconvenience this matter may cause; however we are taking this action to help ensure your safety and continued satisfaction with your vehicle.

Sincerely,

Audi Customer Protection

Safety Precautions When Working ON the High-voltage System (additional information is also available in the ELSA Repair Manual)

DANGER

Extremely dangerous due to high voltage.

- The high-voltage system is under heavy voltage. Severe bodily injury or death by electrocution or electric arcs is possible.
- When working on the high-voltage system the high-voltage system must be de-energized.
- When performing procedures that do not directly affect the high-voltage system, in some cases it is still necessary to de-energize the high-voltage system.
- Pay attention when the high-voltage system must be de-energized. Refer to the Repair Manual
- Have a High-Voltage Technician or a High-Voltage Expert de-energize the high-voltage system.

The electric and magnetic fields are extremely dangerous.

- There are electric and magnetic fields on the high-voltage system. Death or serious injury are possible due to malfunction of active implants (for example cardiac pacemakers, insulin pumps).
- Persons with active implants may not perform procedures on the high-voltage system.

WARNING

Risk of injury - motor may start unexpectedly

It is difficult to determine whether the drive system of an electric vehicle or hybrid vehicle is active. Moving parts can trap or draw in parts of the body.

CAUTION

Risk of damage to high-voltage wiring

- Incorrect handling may result in damage to the insulation of high-voltage wires or high-voltage connectors.
- Do not support yourself on high-voltage cables or connectors.
- Never prop tools against high-voltage wiring or high-voltage connectors.
- Never bend or kink high-voltage wiring.
- Observe the coding of the high-voltage connectors when joining them up.

Safety Precautions When Working NEAR the High-voltage System (additional information is also available in the ELSA Repair Manual)

DANGER

Extremely dangerous due to high voltage.

- The voltage levels in the high-voltage system constitute a safety hazard. Danger of severe or fatal injuries from electric shock if high-voltage components or high-voltage wiring are damaged.
- Carry out a visual check of high-voltage components and high-voltage wiring.
- Never use cutting/forming tools or other sharp-edged implements.
- Never perform work using welding, brazing, thermal bonding or hot air in the area of high-voltage components and high-voltage cables.

DANGER

High voltage increases the risk of fatal injury

Electrocution can cause severe bodily or fatal injury.

- For the following procedures suitable personal protective equipment must be worn.
- For the following steps two correspondingly qualified technicians must be present for the supervision.
- If necessary, a second technician can help the high-voltage expert outside of the hazardous area within their qualification.
- The personal protective equipment (PPE) must be dry and undamaged.

Repair Overview

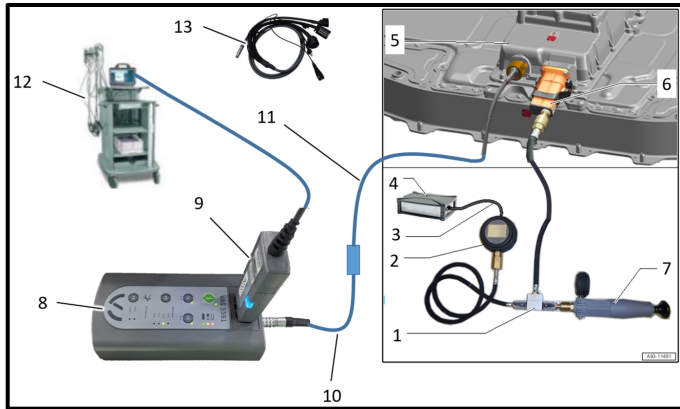







- Perform leak test on high voltage battery.
- Replace high voltage battery, if necessary.

! NOTE

- These repair instructions may differ from the labor operations and labor times listed in ELSA.
- Damages resulting from improper repair or failure to follow these work instructions are the dealer's responsibility and are not eligible for reimbursement under this action.
- This procedure must be read in its entirety prior to performing the repair.
- Due to variations in vehicle equipment and options, the steps/illustrations in this work procedure may not identically match all affected vehicles.
- Diagnosis and repair of pre-existing conditions in the vehicle are not covered under this action.
- When working during extreme temperatures, it is recommended that the vehicle be allowed to acclimate inside the shop to avoid temperature-related component damage/breakage.

Required Tools (for inspection)

	<p>Test Adapter Set -4J3-998-099-</p>
<p>One Test Adapter Set was allocated to specific Audi dealers. DO NOT contact Special Tools and Equipment if additional quantities are needed. If an adapter set is needed, orders can be placed through Parts on Command.</p>	
 <p>Battery Tester/Charger capable of minimum 90 Amp continuous supply</p>	 <p>Diagnostic System Package - VAS6150F/TSP- (or equivalent)</p>
 <p>Warning Sign - "Do Not Switch On" -VAS6650A-</p>	 <p>Warning Sign - High Voltage -VAS6649-</p>
 <p>Padlock -T40262/1- (from Service Disconnect Lock -T40262-)</p>	 <p>Adapter Cable -VAS5581/1A-2-</p>

	<p>Diagnosis Lead -VAS5581A/12-</p>		<p>High Voltage Diagnostics Box -VAS5581A- or -VAS5581-</p>
	<p>Test Instrument Set -VAS6356- (component of Diagnostic System Package -VAS6150F/TSP-)</p>		<p>Digital Pressure Sensor -VAG1397B-</p>
	<p>Cooling System Tester -VAG1274B-</p>		<p>Cooling System Tester - Directional Valve -VAS691005/1- (component of MRT -VAS691005-)</p>
	<p>Leak Tester - Test Connector Set -VAS6911/3B- (or equivalent previous version)</p>		<p>Pressure Sensor -VAS611013-</p>
	<p>Vehicle Diagnosis System - Connection Lead -VAS5051/66-</p>		<p>Adapter Cable -VAS5581/6-</p>

Additional Required Tools (for battery replacement)

	<p>Support (4 Pcs) -VAS6131/19-</p>		<p>Forklift Cross Beam -VAS501009-</p>
	<p>Mounting Lift Bracket Set (4 Pcs) -T40416-</p>		<p>Adapter Set (4 Pcs) -T40416/4-</p>
	<p>Sling Chain -VAS501011-</p>		<p>Scissor Lift Table -VAS6131B-</p>

Repair Instruction

Section A - Check for Previous Repair

TIP

If Campaign Completion label is present, no further work is required.

Applicable criteria ID(s)	Campaign/Action Status
01 	Open 

EXAMPLE

Campaign/Action	Start	Designation
	2015-11-10	W-SERV_ACT -
	2018-12-13	RECALL -
	2017-05-16	A-RECALL -

EXAMPLE

- Enter the VIN in Elsa and proceed to the “Campaign/Action” screen.

TIP

On the date of repair, print this screen and keep a copy with the repair order.

- Confirm the Campaign/Action is open <arrow 1>. If the status is closed, no further work is required.
- Note the Applicable Criteria ID <arrow 2> for use in determining the correct work to be done and corresponding parts associated.

CRITICAL REPAIR STEP

 **STOP!** 

If multiple software update Campaign/Actions are open, they must be performed in order of the Start date <arrow 3>. The oldest should be performed first.

- **All Safety Recalls must be completed prior to completing this campaign.**
- **Proceed to Section B.**

Section B – High Voltage Battery Leak Test

CRITICAL REPAIR STEP

 **STOP!** 

The ODIS software version must be 23.1.1 - Diagnostic Content Version 2.32.4 or higher.

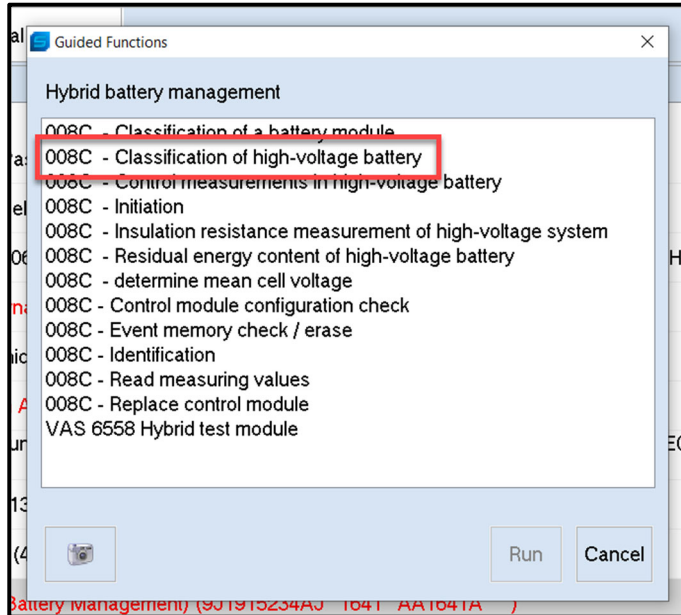

Perform classification of high voltage battery:

- In address 008C, perform the Guided Function test plan “008C – Classification of high-voltage battery”.
- **If the classification result is OK, continue with these instructions.**
- **If the classification result is NOT OK, contact TAC.**

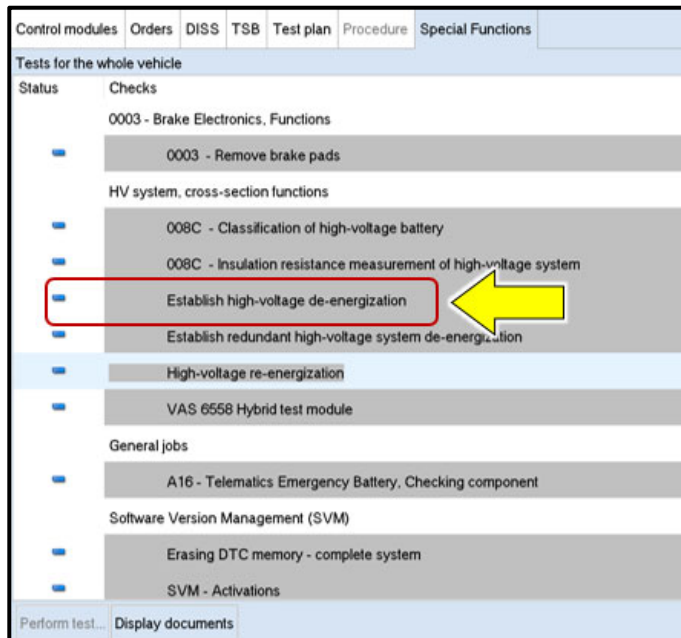

De-energize the high-voltage system:

 **DANGER**

**High voltage increases the risk of fatal injury!
Electrocution can cause severe bodily or fatal injury!**

Have a high-voltage technician or a high-voltage expert de-energize the high-voltage system.

- Attach a 12V battery maintainer/charger.
- Under the special functions tab, select the test plan for “Establish high-voltage de-energization”.
- Follow the test plan steps until the high-voltage system is successfully de-energized.
- Also, reference the ELSA repair manual when de-energizing the high-voltage system: *Repair manual > Motor > Electric Drive Motor OEG > 93 Electric drive > High-Voltage System, De-Energizing.*

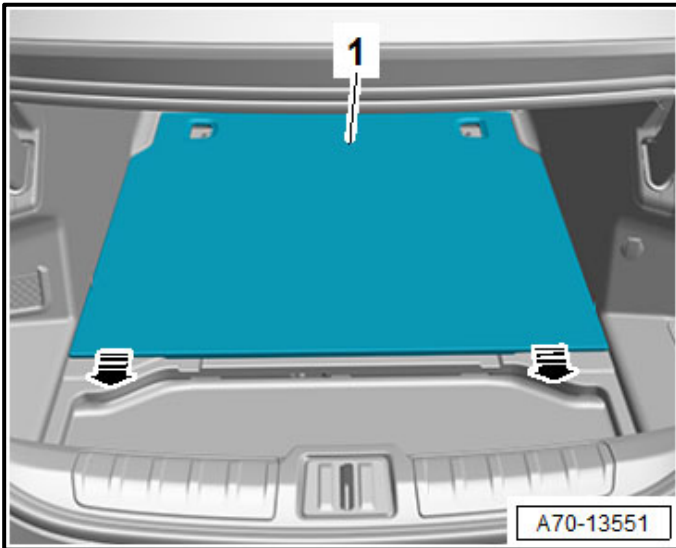

Remove rear luggage compartment floor and trim:

- See ELSA Repair Manual: *Repair manual > Body > 70 Interior Trim > Luggage Compartment Trim Panels > Luggage Compartment Floor, Removing and Installing*

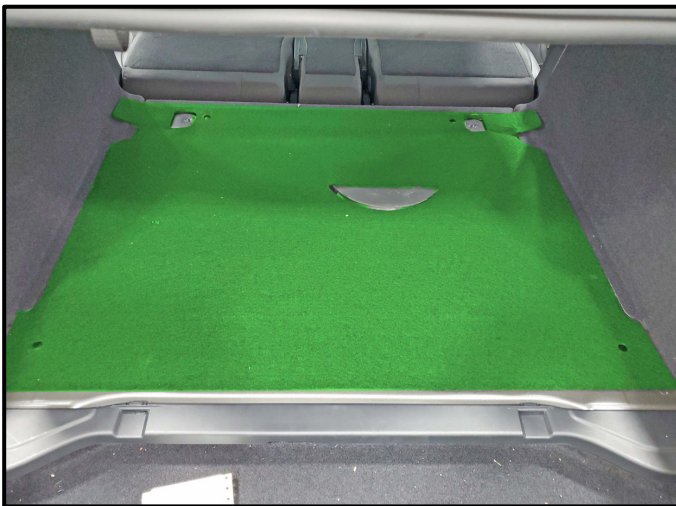

Remove cover:

- Remove cover <arrow> using a trim removal tool.

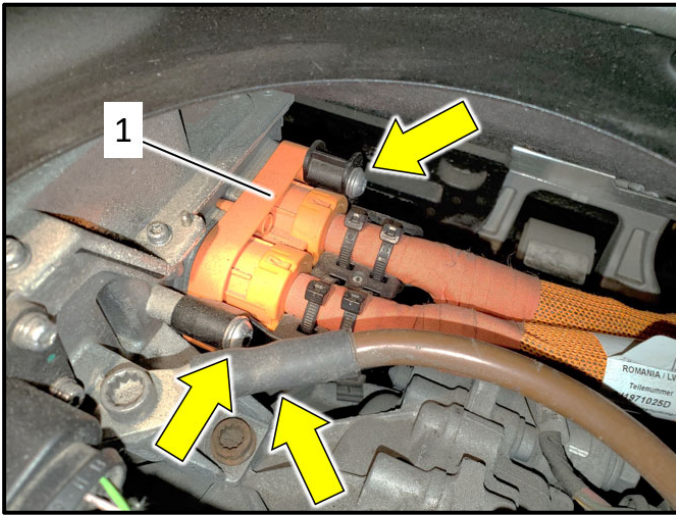

Loosen high voltage connection:

- Loosen the three screws <arrows> and disconnect the high voltage connection <1>.

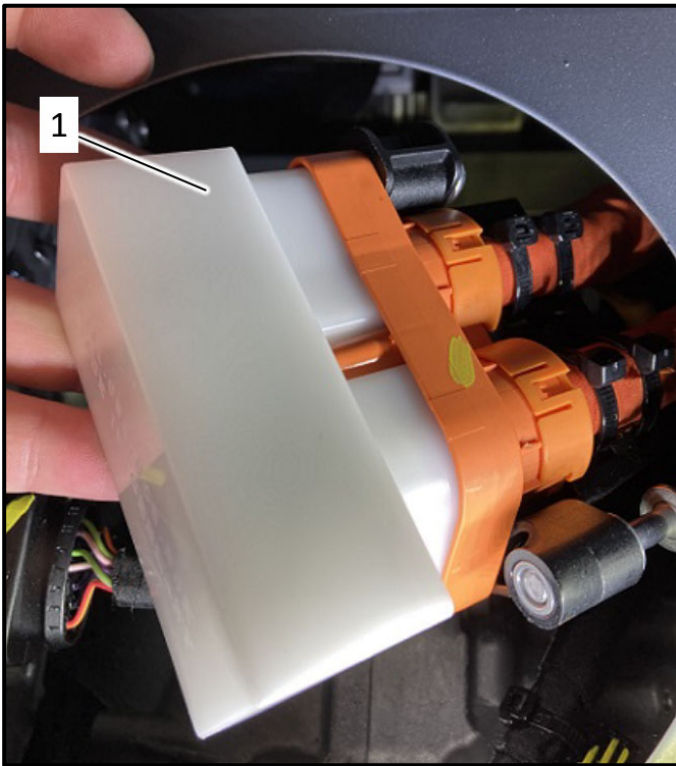

Attach adapter block to cable:

- Attach the adapter block <1> from Test Adapter Set -4J3-998-099-.
- Tighten the two screws on the cable connection hand tight.
- **DO NOT OVERTIGHTEN SCREWS!**
- Move the cable with adapter block to the side. Do not kink the cable.

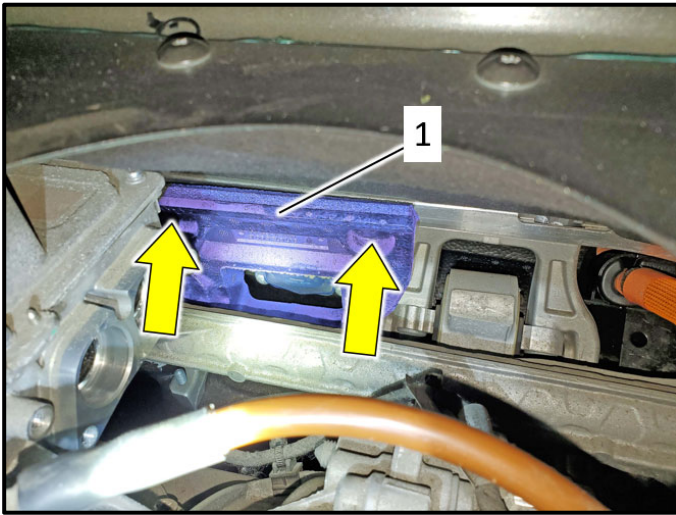

Remove foam insert:

- Carefully unclip the foam insert at the securing pins <arrows> and remove the insert upward.

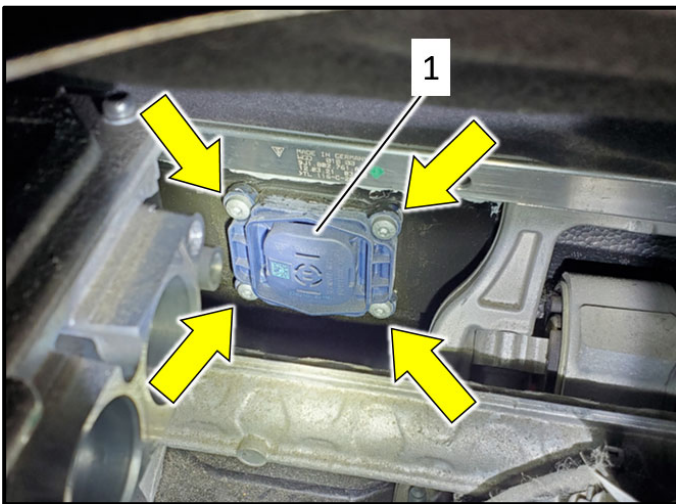

Remove pressure valve:

- Remove bolts <arrows> and remove pressure valve <1>.

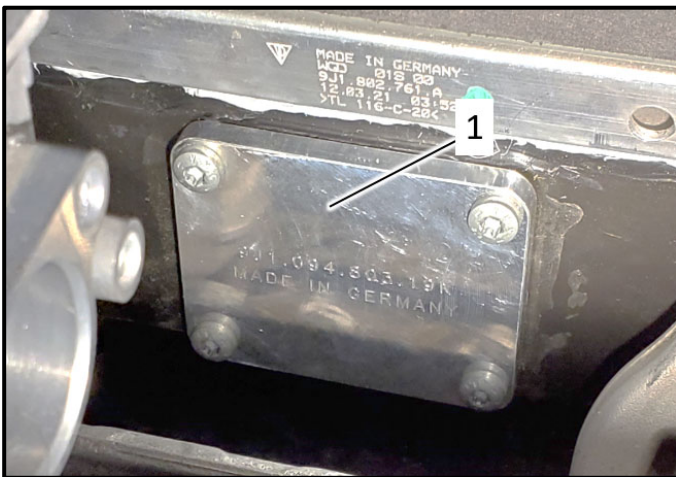

Install adapter plate:

- Ensure the sealing surface on the battery is clean.
- Install adapter plate <1> from Test Adapter Set -4J3-998-099- using the original bolts and torque bolts to 8 Nm.

i TIP

To aid in lining up the plate and installing the bolts, a M6x1.0mm stud or modified bolt can be screwed into one of the bolt holes on the high voltage battery.

Special tool -T40199- can also be used.

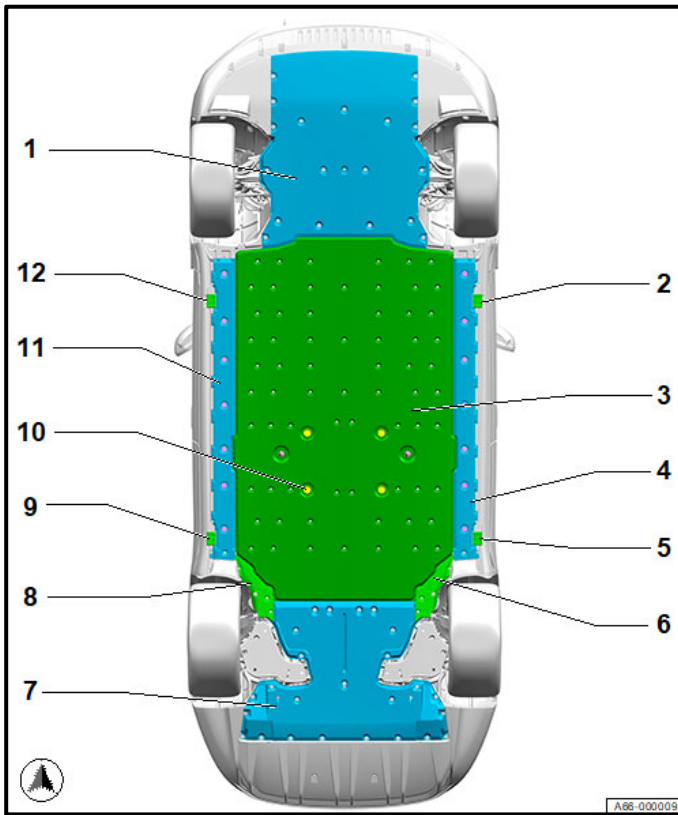

Remove front underbody cover:

- Remove front underbody cover <1> according to the ELSA Repair Manual: *Repair manual > Body > 66 Exterior Equipment > Underbody Trim Panel Overview - Underbody Trim Panels*

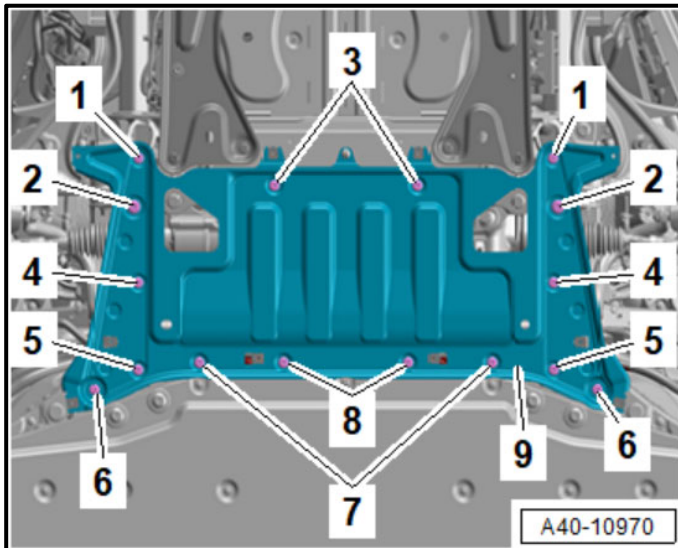

Remove reinforcement:

- Remove reinforcement <9> according to the ELSA Repair Manual: *Repair manual > Chassis > 40 Front Suspension > Subframe > Rear Reinforcement, Removing and Installing*

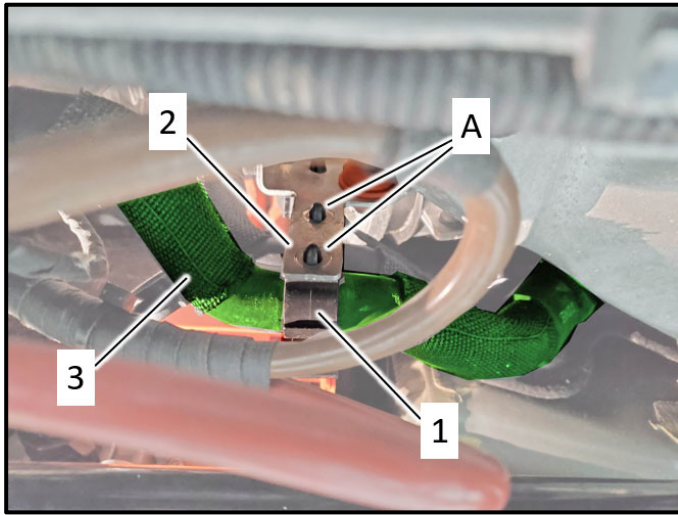

Free up coolant hoses:

- Release locking pins <A> with a pick tool, for example.
- Remove coolant hose holder <1> from bracket <2>.
- Remove the hose holder <1> from coolant hoses <3>.

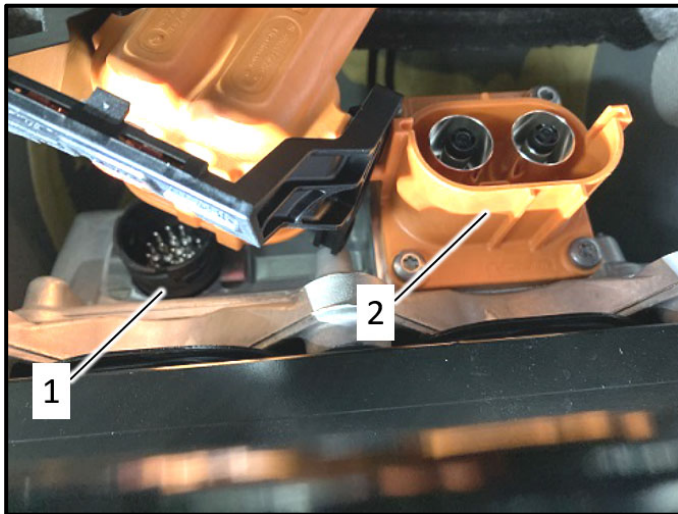

Disconnect high voltage battery connectors:

- Disconnect the HV Battery Switch Box -SX6- connections <1> and <2>.

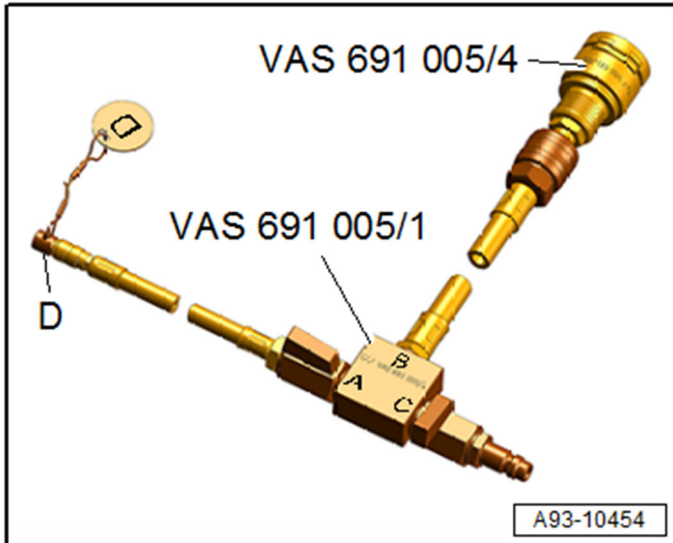

Ensure the testing tools are not leaking:

CRITICAL REPAIR STEP



Checking and cleaning the tools **MUST** be carried out before testing the high voltage battery. This check must be before every battery leak test.

- Cooling System Tester - Directional Valve -VAS691005/1- and Leak Tester - Test Connector Set -VAS6911/3B- must be tested to ensure the tools are not leaking.
- Cooling System Tester - Directional Valve -VAS691005/1- must not have any residual coolant left in it.
- This must be done before performing the high voltage battery leak test.
- See ELSA Repair Manual: *Repair manual > Motor > Electric Drive Motor 0EG > 93 Electric drive > High-Voltage Battery Unit > High-Voltage Battery 1 AX2 Leak Test > Testing Tools, Cleaning and Checking*

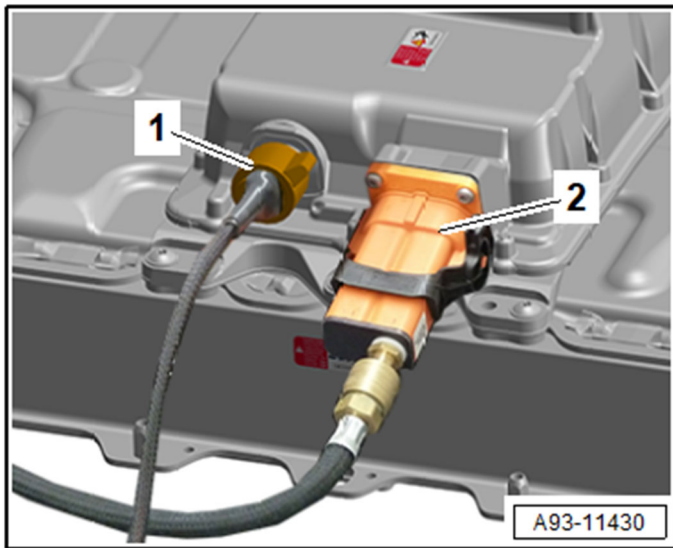
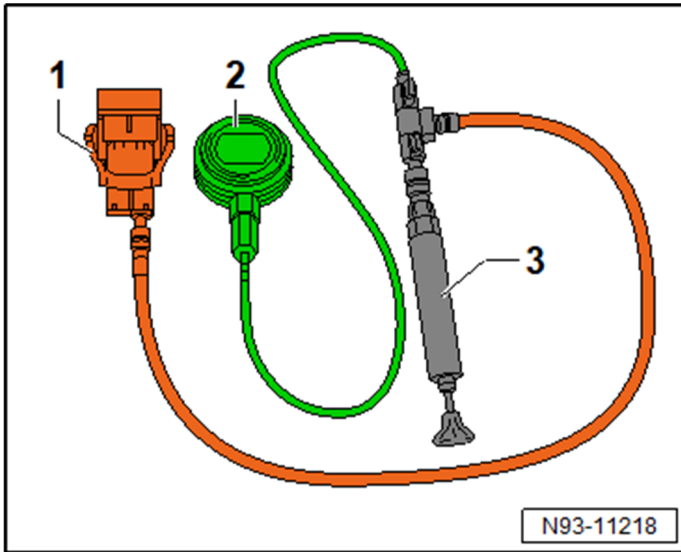

Install pressure test adapters:

- Install Leak Tester -VAS6911/3B- <2> to HV Battery Switch Box -SX6-.
- Install Adapter Cable -VAS5581A/12- <1> to HV Battery Switch Box -SX6-.

NOTE

Diagnosis Lead -VAS5581A/12- will be used to connect the high voltage battery to the High Voltage Diagnostics Box -VAS5581-. This is required to initiate the Guided Functions test plan for the high voltage battery leak test.

The -VAS5581A/12- is not sealed. Therefore, it will have to be replaced with -VAS5581/6- in a later step. Otherwise, the high voltage battery cannot be properly pressurized.

Prepare for the high voltage battery leak test:

- Arrange the tools as shown below to perform the high voltage battery leak test.
- The CAN bus terminating resistor on the High Voltage Diagnostics Box -VAS5581A- <8> is preset to 120 Ω and must not be changed.
- Connect the black ground clamps of the Diagnosis Lead -VAS5581A/12- <11> and Adapter Cable -VAS5581/1A-2- <10> to the ground on the battery housing.

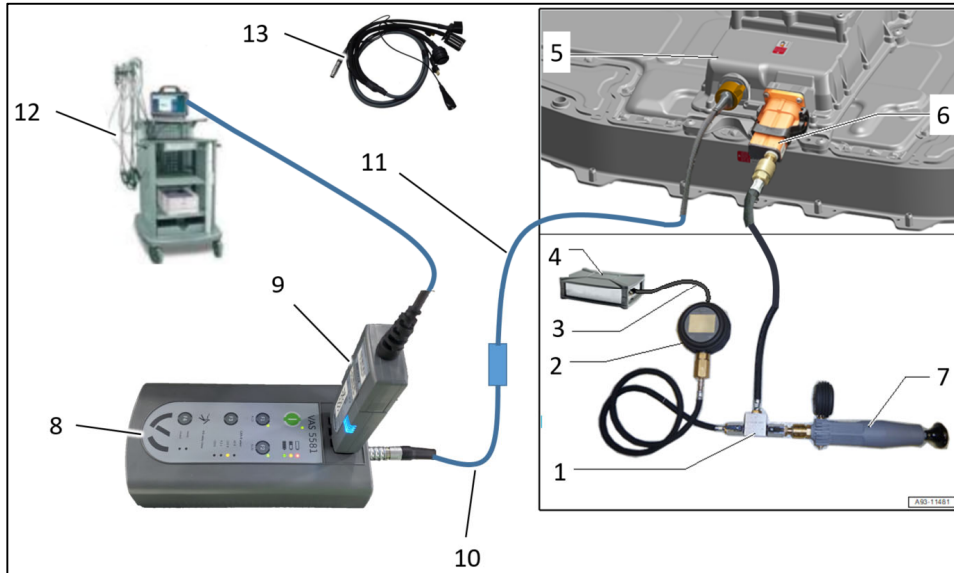

- 1) -VAS691005/1-
- 2) -VAS611013-
- 3) -VAS5051/66-
- 4) -VAS6356-
- 5) HV Battery Switch Box -SX6-
- 6) -VAS6911/3B-
- 7) -VAG1274B-
- 8) -VAS5581- or -VAS5581A-
- 9) Diagnostic Interface
- 10) -VAS5581/1A-2-
- 11) -VAS5581A/12-
- 12) -VAS6150F/TSP-
- 13) -VAS5581/6-

NOTE

- Test Instrument Set -VAS6356- <4> is a component of Diagnostic System Package -VAS6150F/TSP- <12>.
- During the test procedure, Diagnosis Lead -VAS5581A/12- <11> will be removed from the HV Battery Switch Box -SX6- <5> and Adapter Cable -VAS5581/6- <13> will then be connected only to the HV Battery Switch Box -SX6- <5>.

CRITICAL REPAIR STEP

STOP STOP! STOP

- The barrel connector on the -SX6- must be sealed when performing the leak test.
- **It is possible that some -VAS5581/6- ARE NOT SEALED.**
- If an immediate pressure loss is detected, confirm the -VAS5581/6- is not leaking. This can be performed by reconnecting the -SX6- to the vehicle side connector and repeating the pressure test, or by sealing the -SX6- connector by other means.

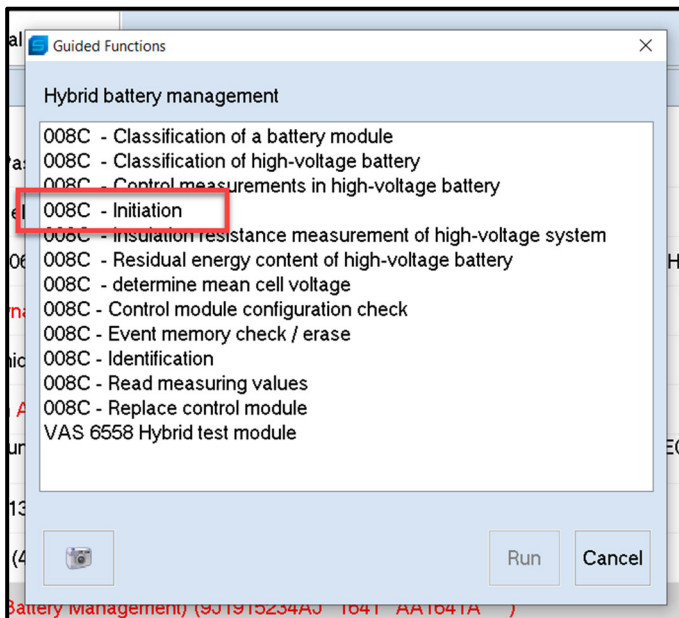

Perform high voltage battery leak test:

- Establish communication between the diagnostic tester and High Voltage Diagnostics Box -VAS5581A- or -VAS5581-.
- In address 008C, start the Guided Function test "008C – Initiation".

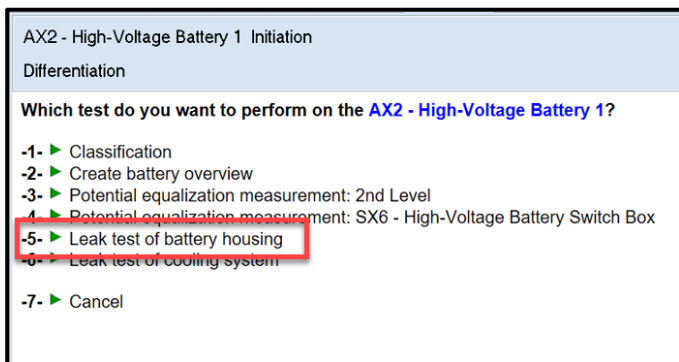

- Select the option to perform a leak test of the battery housing.
- Pay close attention to the test plan steps and follow the on-screen prompts.

⚠ CRITICAL REPAIR STEP

STOP! STOP!

For this test, the pressure deviation tolerance is 0.6 mbar.

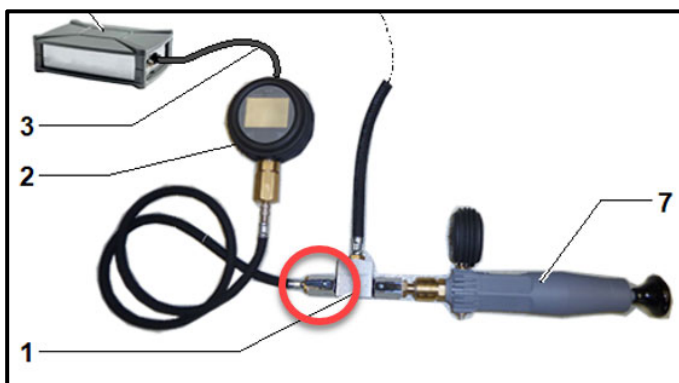

⚠ CAUTION

Risk of damaging pressure gauge -VAS611013-

When pressurizing the high voltage battery, the valve <circle> to the pressure gauge must be closed.

Never apply pressure with pump when the valve is open.

Open the valve at regular intervals and observe the pressure.

Test requirements:

- The cover of the AX2 - High-Voltage Battery 1 is correctly installed according to the Repair Manual.
- The necessary measurement setup itself has already been checked for leaks of the hoses and instruments.
- Disconnect the VAS 5581A/12 Diagnosis Lead from the connector of the switch box
- Connect the VAS 5581/6 Adapter Cable only to the connector of the switch box

 VAS 5581A/12 Diagnosis Lead is not sealed

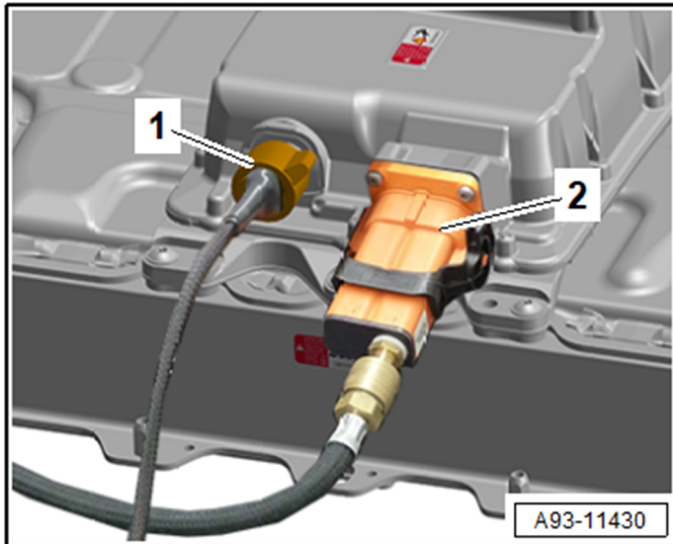

 **CRITICAL REPAIR STEP**

 **STOP!** 

RISK OF A FALSE LEAK TEST RESULT

Diagnosis Lead -VAS5581A/12- is not sealed. It must be replaced with Adapter Cable -VAS5581/6- before pressurizing the high voltage battery case.

 **TIP**

If the first pressure test fails, the -VAS5581/6- can be removed from the -SX6- and the vehicle side connector can be reconnected (the vehicle side connector is sealed).

If the pressure test passes, this will be an indicator that the -VAS5581/6- is leaking.

Evaluate leak test results:

- If the pressure deviation is less than, or equal to 0.6 mbar:
 - The high voltage battery is OK
 - Send the diagnosis log to GFF Paperless
 - Proceed to Section C
- If the pressure deviation is greater than **0.6** mbar, the pressure test must be repeated a second time (see below for more information).
- Ensure none of the test adapters or testing tools are not leaking. Check all connecting elements, connection points, couplings and the hand pump for leaks using a leak detection spray.
- Before the second leak test, the system must have the pressure completely released. Open all valves, remove the -VAS5581/6- from the -SX6- and wait 15 minutes before starting the second leak test.
- If the pressure deviation is still greater than **0.6** mbar:
 - The high voltage battery must be replaced.
 - Additional test steps may also be required once the high voltage battery is removed.
 - Proceed to Section D.
- If the pressure deviation is less than **0.6** mbar after the second test:
 - The high voltage battery is OK
 - Proceed to Section C

CRITICAL REPAIR STEP

 **STOP!** 

If the pressure test fails, ALL testing equipment MUST be inspected closely for leaks, improper installation before performing the second test.

- Ensure the sealing surface for the adapter plate on the rear of the battery is free of debris, oil, etc.
- Ensure the adapter block for the HV cable is fully seated.
- The -VAS6356- configuration must be set up correctly (refer to AHW-23-04 “VAS 6356 Test Instruments Box ODIS Configuration” for more details).
- Common equipment failure points include, but are not limited to:
 - Quick connect to pressure gauge - VAS611013- leaking
 - Pressure gauge -VAS611013- leaking
 - Quick connect to -VAS6911/3B- leaking
 - Valve block on -VAS691005/1- leaking
- The testing adapters MUST be checked before EVERY HV battery leak test according to the ELSA Repair Manual.
- Performing the leak test without the -VAS691005/1- connected to the -VAS6911/3B- will aid in determining if there is an issue with the testing equipment. If the test fails with the HV battery not connected, you will know that the testing equipment is at fault.

Section C – Vehicle Reassembly

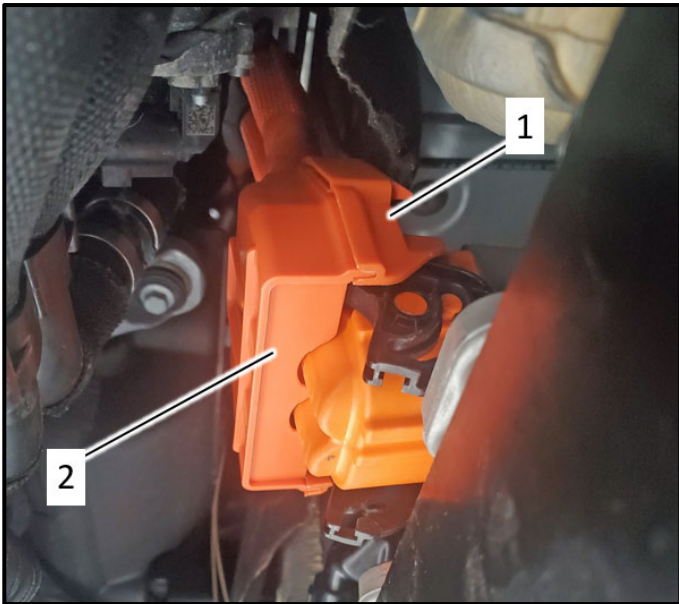

Reassemble vehicle in the reverse order of removal:

- Ensure connections to the High Voltage Battery Switch Box -SX6- are securely locked.
- Install covers <1 and 2> over high voltage connector.
- Secure coolant hoses and bracket.

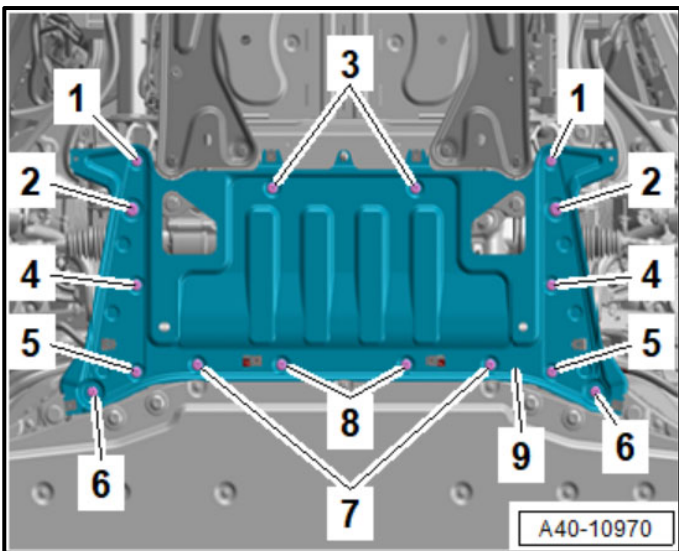

- Reinstall reinforcement and torque fasteners as follows:

Step	Sequence	Specification
1	<1> through <8>	Install all the way by hand
2	<1>	30 Nm
3	<2>	55 Nm
4	<3> to <8>	30 Nm

- Install underbody shield and torque screws to 2.5 Nm.

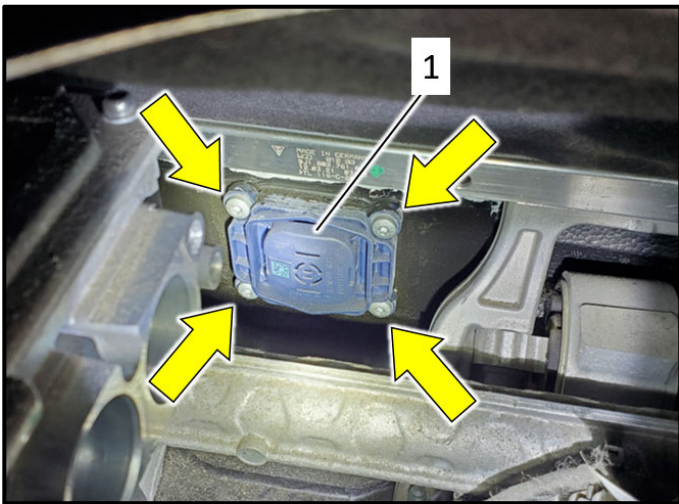

- Remove adapter plate.
- Install new pressure valve <1> with new bolts <arrows>.
- Torque new bolts <arrows> to 8 Nm.

Part Number	Part Description
9J1-915-754	Pressure Valve
N -107-002-01	Bolt (x4)

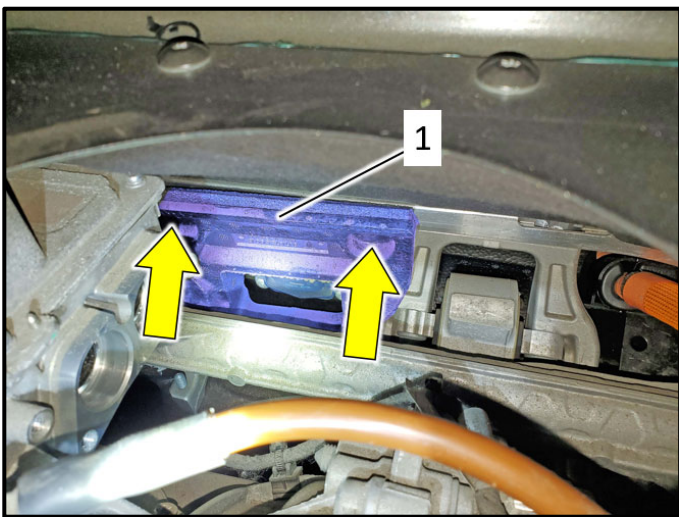

- Reinstall foam insert <1> and ensure securing pins <arrows> are fully engaged.

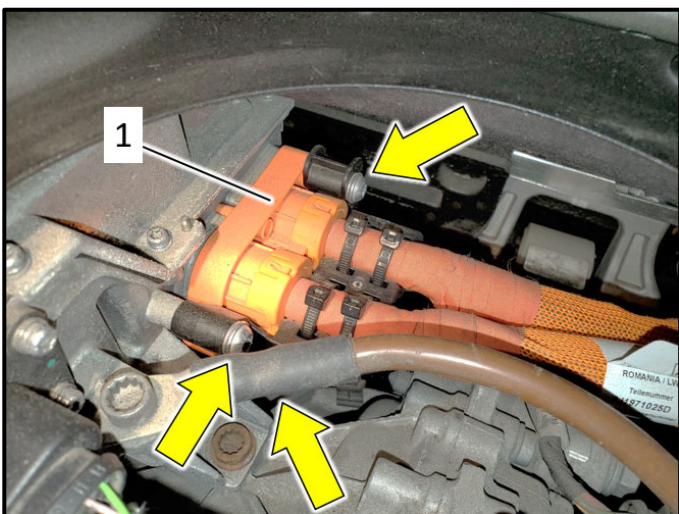

- Remove adapter block from high voltage cable.
- Connect high voltage cable <1> and torque screws <arrows> to 8 Nm.



- Reinstall cover <arrow>.

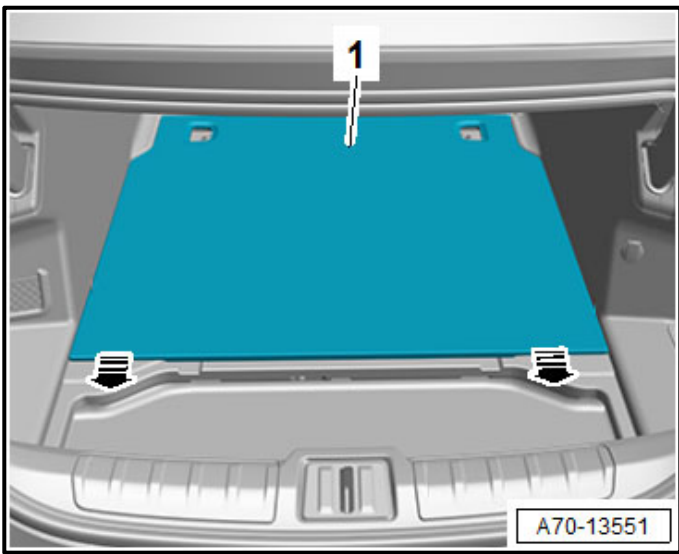

- Reinstall luggage compartment lining and floor.
- Torque tie-down bolts to 20 Nm.

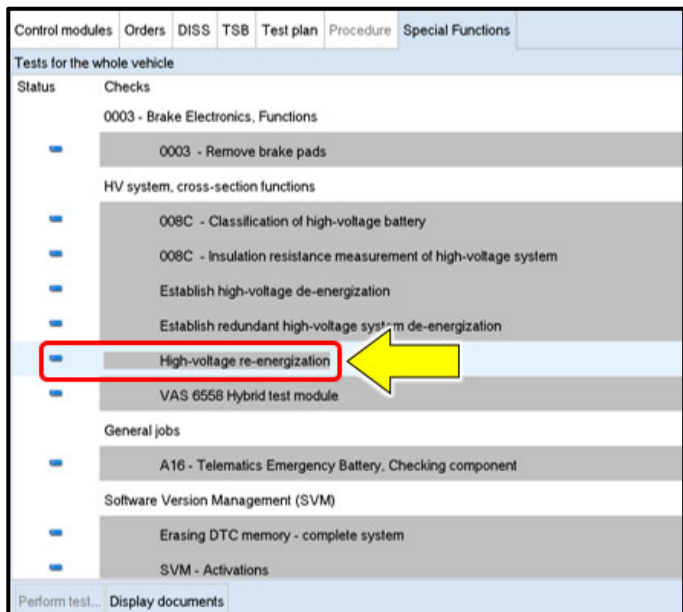

Re-energize the high-voltage system:

⚠ DANGER

**High voltage increases the risk of fatal injury!
Electrocution can cause severe bodily or fatal injury!**

Have a high-voltage technician or a high-voltage expert bring the high-voltage system back into service.

- Under the special functions tab, select the test plan for “high-voltage re-energization”.
- Follow all the test plan steps until the high-voltage system is successfully re-energized.
- Also, reference the ELSA repair manual when re-energizing the high-voltage system: *Repair manual > Motor > Electric Drive Motor 0EG > 93 Electric drive > High-Voltage System, Re-Energizing.*
- Clear the fault memory by exiting the ODIS session.
- Send the log to GFF Paperless.

Proceed to section E

Section D – High Voltage Battery Replacement

- Create a TAC WEB ticket to document the high voltage battery replacement and provide the following information:
 - What was used to seal the -SX6-barrel connector.
 - Photo of battery sticker showing the battery serial number.
 - Diagnosis ID(s) from GFF log(s) which include the classification test results and leak test results.
- Once the battery is removed from the vehicle, additional testing and documentation may be required. This information, if needed, will be provided in the TAC case.
- When replacing the high voltage battery, the production date of the NEW battery must be checked.
- If the production date is 08.05.2023 or later, the battery can be installed right away.



NOTE

The production date on the label is in the DD/MM/YYYY format.

- High voltage batteries with an earlier production date must be pressure tested **once** before installation.
- If the pressure test of the new high voltage battery fails, contact TAC.

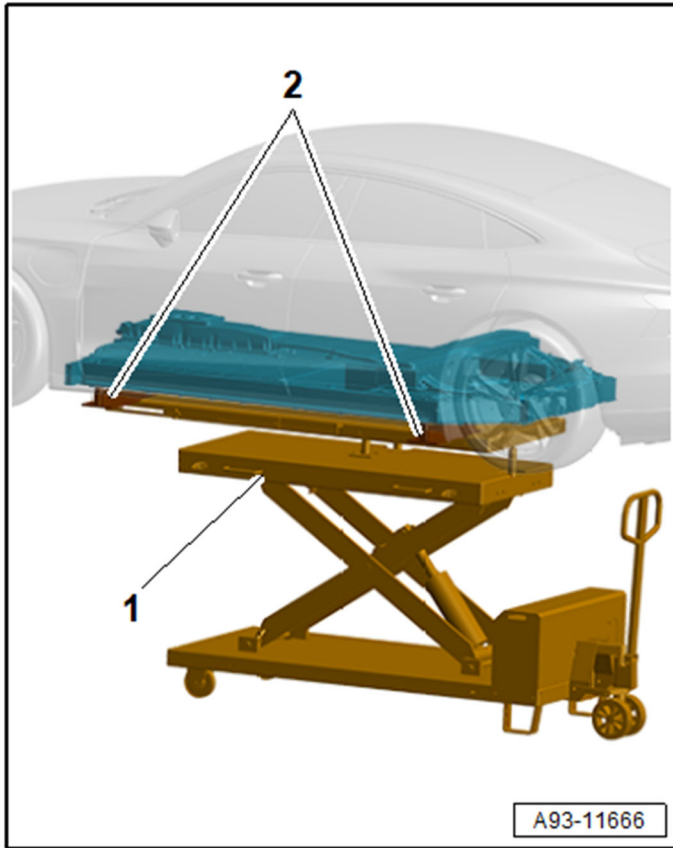

⚠ DANGER

**High voltage increases the risk of fatal injury!
Electrocution can cause severe bodily or fatal injury!**

Have a high-voltage technician or a high-voltage expert de-energize the high-voltage system.

- Reference the ELSA repair manual for replacing the high voltage battery: *Repair manual > Motor > Electric Drive Motor OEG > 93 Electric drive > High-Voltage Battery Unit > High-Voltage Battery 1 AX2, Removing and Installing*

Proceed to Section E

Section E – Campaign Completion Stamp

I certify that this campaign
has been performed in strict
accordance with the applicable
Audi repair procedure.

SAGA Code: _____
Technician: _____
Date: _____

Item#: AUD4927ENG

-OR-

Je certifie que cette
campagne de rappel a été
exécutée suivant les strictes
directives de réparation
d'Audi

Code de SAGA: _____
Technicien: _____
Date: _____

Item # AUD4927FRE

- Once the campaign has been completed, the technician should stamp the repair order.
- Stamps are available for ordering through the Compliance Label Ordering Portal.

US DEALERS - Proceed to Section F

CANADIAN DEALERS - Proceed to Section G

Section F - Parts Return/Disposal – US DEALERS ONLY

High-Voltage Battery:

Refer to the latest instructions for high-voltage battery recycling, found in Elsa2Go: *Elsa2Go-> Infomedia->Service References->Electric Vehicle Category ->“HV Battery Recycling Program Guide”*

Battery assemblies to be sent for recycling under campaign 93T7 must use DDR compliant packaging for transportation. Please ensure you specify the battery is DDR when submitting the request.

All other parts:

Properly store (retain), destroy or dispose of removed parts in accordance with all state/province and local requirements, unless otherwise indicated and/or requested through the Warranty Parts Portal (WPP).

Section G - Parts Return/Disposal – CANADIAN DEALERS ONLY

High-Voltage Battery:

Refer to the latest version of TSB 2062871.

Battery assemblies to be sent for recycling under campaign 93T7 must use DDR compliant packaging for transportation.

All other parts:

Properly store (retain), destroy or dispose of removed parts in accordance with all state/province and local requirements, unless otherwise indicated and/or requested through the Part Destruction and Core Disposition Report for Canada.